

# PowerFlex 750-Series AC Drives

Firmware Revisions 1.xxx . . . 14.xxx



## Important User Information

Read this document and the documents listed in the additional resources section about installation, configuration, and operation of this equipment before you install, configure, operate, or maintain this product. Users are required to familiarize themselves with installation and wiring instructions in addition to requirements of all applicable codes, laws, and standards.

Activities including installation, adjustments, putting into service, use, assembly, disassembly, and maintenance are required to be carried out by suitably trained personnel in accordance with applicable code of practice.

If this equipment is used in a manner not specified by the manufacturer, the protection provided by the equipment may be impaired.

In no event will Rockwell Automation, Inc. be responsible or liable for indirect or consequential damages resulting from the use or application of this equipment.

The examples and diagrams in this manual are included solely for illustrative purposes. Because of the many variables and requirements associated with any particular installation, Rockwell Automation, Inc. cannot assume responsibility or liability for actual use based on the examples and diagrams.

No patent liability is assumed by Rockwell Automation, Inc. with respect to use of information, circuits, equipment, or software described in this manual.

Reproduction of the contents of this manual, in whole or in part, without written permission of Rockwell Automation, Inc., is prohibited

Throughout this manual, when necessary, we use notes to make you aware of safety considerations.



**WARNING:** Identifies information about practices or circumstances that can cause an explosion in a hazardous environment, which may lead to personal injury or death, property damage, or economic loss.



**ATTENTION:** Identifies information about practices or circumstances that can lead to personal injury or death, property damage, or economic loss. Attentions help you identify a hazard, avoid a hazard, and recognize the consequence.

---

**IMPORTANT** Identifies information that is critical for successful application and understanding of the product.

---

Labels may also be on or inside the equipment to provide specific precautions.



**SHOCK HAZARD:** Labels may be on or inside the equipment, for example, a drive or motor, to alert people that dangerous voltage may be present.



**BURN HAZARD:** Labels may be on or inside the equipment, for example, a drive or motor, to alert people that surfaces may reach dangerous temperatures.



**ARC FLASH HAZARD:** Labels may be on or inside the equipment, for example, a motor control center, to alert people to potential Arc Flash. Arc Flash will cause severe injury or death. Wear proper Personal Protective Equipment (PPE). Follow ALL Regulatory requirements for safe work practices and for Personal Protective Equipment (PPE).

---

	<b>Preface</b>	
	Summary of Changes . . . . .	9
	Product Certification . . . . .	11
	Manual Conventions . . . . .	11
	General Precautions . . . . .	12
	Qualified Personnel . . . . .	12
	Personal Safety . . . . .	12
	Product Safety . . . . .	13
	Class 1 Light-emitting Diode Product . . . . .	13
	Additional Resources . . . . .	14
	 <b>Chapter 1</b>	
<b>Startup</b>	Start-Up Check List . . . . .	17
	Prepare For Initial Drive Startup . . . . .	17
	Start-Up Menu . . . . .	19
	Drive Status Indicators . . . . .	20
	Establishing A Connection With EtherNet/IP . . . . .	21
	 <b>Chapter 2</b>	
<b>Parameter Organization</b>	About Parameters . . . . .	24
	Parameter Access Level . . . . .	25
	How Drive Parameters are Organized . . . . .	26
	Basic Parameter View (Port 0) . . . . .	26
	Advanced Parameter View (Port 0) . . . . .	28
	Expert Parameter View (Port 0) . . . . .	34
	Inverter Common (Port 10) . . . . .	42
	Inverter <i>n</i> (Port 10) . . . . .	42
	Converter Common (Port 11) . . . . .	43
	Converter <i>n</i> (Port 11) . . . . .	43
	Precharge Common (Port 11) . . . . .	44
	Precharge <i>n</i> (Port 11) . . . . .	44
	Embedded EtherNet/IP (Port 13) . . . . .	45
	Embedded DeviceLogix (Port 14) . . . . .	46
	How Option Module Parameters are Organized . . . . .	47
	11-Series I/O Modules . . . . .	47
	22-Series I/O Modules . . . . .	48
	Single Incremental Encoder Module . . . . .	49
	Dual Incremental Encoder Module . . . . .	49
	Universal Feedback Module . . . . .	50
	Safe Speed Monitor Module . . . . .	51
	 <b>Chapter 3</b>	
<b>Drive Port 0 Parameters</b>	Drive (Port 0) Monitor File . . . . .	54
	Drive (Port 0) Motor Control File . . . . .	56
	Drive (Port 0) Feedback & I/O File . . . . .	70
	Drive (Port 0) Cfg File . . . . .	86

	Drive (Port 0) Protection File .....	102
	Drive (Port 0) Speed Control File .....	117
	Drive (Port 0) Torque Control File .....	132
	Drive (Port 0) Position Control File .....	139
	Drive (Port 0) Communication File .....	154
	Drive (Port 0) Diagnostics File .....	161
	Drive (Port 0) Applications File .....	180
	 <b>Chapter 4</b>	
<b>Port 10 and Port 11 Parameters</b>	Inverter (Port 10) Common Parameters.....	222
	Inverter <i>n</i> (Port 10) Parameters.....	224
	Converter (Port 11) Common Parameters .....	227
	Converter <i>n</i> (Port 11) Parameters .....	229
	Precharge (Port 11) Common Parameters.....	232
	Precharge <i>n</i> (Port 11) Parameters.....	234
	 <b>Chapter 5</b>	
<b>Embedded Feature and Option Module Parameters</b>	Embedded EtherNet/IP (Port 13) Parameters .....	240
	Communication Configurations .....	246
	20-COMM-* Network Adapter Compatibility .....	246
	Typical Programmable Controller Configurations.....	246
	Logic Command/Status Words.....	247
	Embedded DeviceLogix (Port 14) Parameters.....	249
	11-Series I/O Module Parameters .....	252
	22-Series I/O Module Parameters .....	262
	Single Incremental Encoder Module Parameters .....	273
	Dual Incremental Encoder Module Parameters .....	276
	Universal Feedback Module Parameters .....	281
	Safe Speed Monitor Module Parameters.....	299
	 <b>Chapter 6</b>	
<b>Troubleshooting</b>	Faults, Alarms, and Configurable Conditions.....	311
	Faults.....	311
	Alarms.....	312
	Configurable Conditions.....	313
	View Faults and Alarms .....	314
	Drive Status Indicators .....	314
	HIM Indication.....	316
	Fault Display Screen .....	316
	Manually Clearing Faults .....	316
	Power Layer Interface (PLI) Board 7-Segment Display .....	317
	Setting Factory Defaults .....	318
	System Resource Allocation .....	318
	Hardware Service Manual.....	319
	Integrated Motion Applications.....	319

	Fault and Alarm Display Codes.....	319
	Parameter Access Level .....	319
	Drive Fault and Alarm Descriptions .....	320
	Inverter (Port 10) Faults and Alarms (Frame 8 and Larger) .....	340
	Converter (Port 11) Faults and Alarms (Frame 8 and Larger) ....	345
	Precharge (Port 11) Faults and Alarms (Frame 8 and Larger).....	350
	N-1 and Re-Rate Functions .....	353
	N-1 and Re-Rating with Integrated Motion on	
	EtherNet/IP .....	353
	Use the N-1 Feature .....	353
	Use the Re-Rate Feature.....	354
	Use the Re-Rate Feature to Add or Replace a Drive	
	Assembly .....	355
	Embedded EtherNet/IP	
	(Port 13) Events.....	357
	I/O Faults and Alarms.....	359
	Safe Torque Off Fault .....	359
	ATEX Faults .....	360
	Single Incremental Encoder Faults and Alarms.....	360
	Dual Incremental Encoder Faults and Alarms.....	361
	Universal Feedback Faults and Alarms .....	362
	Port Verification .....	369
	Common Symptoms and Corrective Actions .....	369
	PowerFlex 755 Lifting/Torque Proving .....	372
	External Brake Resistor .....	372
	Technical Support Options .....	373
	What You Need When You Call Tech Support.....	373
	Technical Support Wizards .....	374
	<b>Appendix A</b>	
<b>PowerFlex 753 Control Block Diagrams</b>	Diagram Conventions and Definitions.....	376
	<b>Appendix B</b>	
<b>PowerFlex 755 Control Block Diagrams</b>	Diagram Conventions and Definitions.....	412
	<b>Appendix C</b>	
<b>Application Notes</b>	Voltage Tolerance.....	455
	PowerFlex 755 Lifting/Torque Proving .....	456
	Tuning the Motor for Torque Prove Applications.....	457
	Crane Set up with Encoder Feedback .....	458
	Set Up the Drive .....	459
	Motor Tune Routines.....	459
	Static Tune .....	460
	Rotate Tune .....	461
	Inertia Tune .....	462
	Torque Prove .....	464

Troubleshooting .....	466
Crane Setup - Encoderless.....	467
Set Up the Drive .....	468
Motor Tune Routines.....	468
Static Tune .....	469
Rotate Tune .....	470
Inertia Tune .....	471
Torque Prove .....	473
Troubleshooting .....	474
Pump Off Function .....	475
Overview .....	475
Setup .....	475
Gather Motor and Pump Data.....	476
Enter Motor Data .....	476
Run Motor Tune Routine.....	477
Enter Pump Data.....	478
Enter Desired Bus Regulation Data .....	478
Store Pump Cycle Torque.....	480
Initialize Pump Stroke Position.....	480
Initialize the Pump Off Feature.....	481
Fine-Tuning .....	482
Sleep Mode .....	482
Pump Off Control Outlines.....	483
Predictive Maintenance with Logix .....	488
Predictive Maintenance for Wall Mount Drives (Frame 1...7) .....	488
Predictive Maintenance for Floor Mount Drives (Frame 8...10) .....	489

**Appendix D**

**Using DeviceLogix**

Introduction.....	495
Parameters.....	497
Function Block Elements .....	497
Macro Blocks .....	497
Bit and Analog I/O Points .....	498
Bit Inputs .....	498
Bit Outputs .....	498
Analog Inputs .....	499
Analog Outputs .....	499
Tips.....	500
Data Types.....	500
PowerFlex 755 v1.xxx Firmware Datalinks and internal DeviceLogix scratchpad registers (P54...P81) .....	500
PowerFlex 753 (all) and PowerFlex 755 v2.xxx (and higher) Datalinks and internal DeviceLogix scratchpad registers (P82...P105) .....	501
Program Examples.....	502

	Example 1: Selector Switch Operation.....	502
	Example 2: Scale Block Operation .....	505
	Example 3: Diverter Operation .....	507
	Example 4: Wet Well Operation.....	508
	Example 5: Utilizing the Real-Time Clock.....	511
	<b>Appendix E</b>	
<b>Permanent Magnet Motors</b>	Compatible Allen-Bradley Servo Motors .....	513
	<b>Appendix F</b>	
<b>Integrated Motion on EtherNet/ IP Application</b>	Introduction.....	517
	Feedback Configuration Options.....	519
	Considerations for Using Position Feedback Devices on the PowerFlex 755 in the Integrated Motion on EtherNet/IP Context.....	519
	Torque Prove and Brake Slip Detect .....	523
	Encoder Feedback Operation.....	524
	Settings .....	525
	Encoderless Operation (Velocity or Frequency Sensorless Vector) .....	526
	PowerFlex 755 Integrated Motion Using Firmware	
	Revision 12.001 or Later .....	527
	Add an I/O Module to a PowerFlex 755 Drive .....	527
	Configure 20-bit or 24-bit Motor Feedback Device Resolution .....	528
	Parameter / Instance Attribute Mapping .....	529
	Motor Overload.....	533
	Positive and Negative Overtravel Input.....	533
	Pre-charge OK Input .....	533
	Brake Output .....	533
	Regeneration OK Input .....	534
	Contactor Enable Output.....	534
	Analog Input and Output .....	534
	Digital Input and Output .....	534
	Motor Thermostat Input.....	534
	SSI Rotary Full Digital Feedback.....	535
	24-bit Device Feedback Configuration .....	535
	Enhanced Attributes .....	536
	Drive Parameter / Enhanced Attribute Mapping.....	537
	Inverter Parameter / Enhanced Attribute Mapping.....	540
	Converter Parameter / Enhanced Attribute Mapping.....	541
	Precharge Parameter / Enhanced Attribute Mapping.....	541
	Encoder Parameter / Enhanced Attribute Mapping .....	541
	I/O Parameters.....	542
	Faults .....	543
	Additional Resources.....	546

**Index** ..... 547



The purpose of this manual is to provide you with the basic information required to install, start-up, and troubleshoot PowerFlex® 750-Series Adjustable Frequency AC Drives. This manual is intended for qualified personnel. You must be able to program and operate Adjustable Frequency AC Drive devices. In addition, you must have an understanding of the parameter settings and functions. The PowerFlex 750-Series AC Drives Quick Start, publication [750-QS001](#), is designed to provide only basic start-up information.

## Summary of Changes

This manual contains new and updated information as indicated in the following table.

Topic	Page
Changed title of <a href="#">20HIM-UM001</a> link to “PowerFlex 20-HIM-A6 and 20-HIM-C6S HIM (Human Interface Module) User Manual” which is the current name of the document. Was shown as “Enhanced PowerFlex 7-Class Human Interface Module (HIM) User Manual.”	Various
Changed Step 5 to a step instead of a description.	18
Added Port 10 and Port 11 to opening sentence of Parameter Organization Chapter 2.	23
Added parameters 409 [Dec Inhibit Actn], 410 [Motor OL Actn], 435 [Shear Pin 1 Actn], 449 [Power Loss Actn], and 950 [Minor Flt Cfg] to the Protection folder in the Basic Parameter View (Port 0) table.	
Added parameters 409 [Dec Inhibit Actn], 410 [Motor OL Actn], 435 [Shear Pin 1 Actn], 438 [Shear Pin 2 Actn], 444 [OutPhaseLossActn], 449 [Power Loss Actn], 462 [InPhase LossActn], 466 [Ground Warn Actn], and 950 [Minor Flt Cfg], to the Flt/AlarmCfg section of the Protection folder in the Advanced Parameter View (Port 0) table and also in the Expert Parameter View (Port 0) table.	28, 34
Parameters 1629 and 1641 have been changed from [IPM Bus Prot] and [IPM Max Spd] to [PM Bus Prot] and [PM Vel Max], respectively. Names and descriptions have been updated throughout the manual.	34, 69
Added parameters 365 [FS Brk Lvl], 366 [FS Brk Time], 367 [FS ZSpd Thresh] to the Drive Configuration file in the Start Features Group in the Expert Parameter View (Port 0) table.	36
Added parameter 303 [Fdbk Filter Cfg].	55
Added note to parameter 35 [Motor Ctrl Mode] to mention that motor data for permanent magnet motors is found in the Motor Name Plate and Rating Specifications table in Appendix E: Permanent Magnet Motors.	57
Changed max values on parameters 1653 [IPM Tran PWM], 1654 [IPMTran PWM Hyst], 1655 [IPM Tran Mode], and 1656 [IPM TranMod Hyst].	60
Added parameter 1662 [IPM SpdEstKp Hi].	61
Updated parameter 80 [PM Cfg] to include definitions for bits 8 and 9.	64
Updated the description of behavior when drive is operating as a speed regulator in parameter 196 [DI Fwd End Limit].	76
Updated the description of behavior when drive is operating as a speed regulator in parameter 198 [DI Rev Dec Limit]	77
Updated description of parameters 226 [Dig Out Invert] and 227 [Dig Out Setpoint] to show RW instead of RO.	79
Added parameters 338 [AutoClrFlt Tries], 339 [AutoClrFlt Delay], 340 [AutoClrCntrDelay], and 343 [Rstrtr Cntr Delay], to port 0.	92
Updated parameter 347 [Auto Retry Fault], added bit 1, AutClrAttExh (Auto clr flts) to allow enabling the Auto Clear Fault Exhausted fault action.	93
Added “Sweep 2” to parameter 356 [FlyingStart Mode]. This frequency sweep mode is used with motor frequencies above 120 Hz.	95
Changed Max value of parameter 461 to Based on Drive Voltage (230, 460, 600, and 690).	107

Topic	Page
Updated parameter 489 [HSFan TotalLife] and parameter 490 [HSFan ElpsdLife] to show that the default value can be based on the drive rating.	110
Updated parameter 491 [HSFan RemainLife] to show that the default value can be based on the drive rating.	111
Added parameters 1680 [DI EmergencyOVRD], 1681 [Emerg OVRD Mode], 1682 [Purge Frequency], 1683 [Emerg Prot Ovr], and 1684 [EmergMode Status] to describe the parameters associated with the new Emergency Override feature.	115 and 116
Updated parameter 731 [Homing Control] with bit 8 to allow configuration of the homing function to return home based on a hard stop detection.	142
Added parameters 739 [Home Trq Thresh], 740 [Home Trq Time], 741 [Home Trq Level], 742 [Home Torq Offset], 743 [Home Return Spd], and 744 [Home Decel]	143
Added bit 15 "Emrg OvrRide" to parameter 935.	163
Updated parameter 936 [Condition Sts 1] to add bits 14 "AutoClr Act" and 15 "AutClrCntDwn."	166
Updated descriptions of parameters 1068 [PID Ref AnlgHi], 1069 [PID Ref AnlgLo], 1070 [PID Setpoint], 1071 [PID Ref Mult], 1073 [PID Fdbk AnlgHi], 1074 [PID Fdbk AnlgLo] so that they refer to percentage of referenced value rather than just motor base speed.	181
Updated parameter 1100 [Trq Prove Cfg] to add bit 10 "BrkSlpFltCfg."	184
Updated max value on parameter 1110 [Brk Slip Count].	186
Updated parameter 1114 [Brake Test Torq] Min/Max values.	186
Updated parameter 1169 [TorqAlarm Config] to add bit 1, "Torq Lvl Low."	190
Added parameter 1185 [TorqAlarm LoLvl] to set the level at which the Torque Low Alarm becomes active.	191
Updated parameter 1188 [Pump Off Setup] to add bit 4, "Dis Baseline" which can enable or disable baseline function.	192
Added parameter 1208 [DI Pump Baseline] to select the digital input source for the Pump Baseline Disable Function.	194
Updated table in Faults, Alarms, and Configurable Conditions section to describe new auto reset for auto clear feature.	311
Updated introductory section in Fault and Alarm Display Codes section to reference descriptions of Auto Reset, Auto Clear, and new Emergency Override columns.	320
Added Auto Clear and Emerg Prot OVRD columns to Drive Fault and Alarm Types, Descriptions, and Actions table.	320
Added more actions to event 12 "HW OverCurrent" and event 13 "Ground Fault" in the Drive Fault and Alarm Types, Descriptions, and Actions table.	320
Added event 30 "Relay0 Life" to Drive Fault and Alarm Types, Descriptions, and Actions table.	323
Added event 34 "AutClrFltExhaust" to the Drive Fault and Alarm Types, Descriptions, and Actions table.	323
Added events 66 "OW Torq Level" and 68 "OW Torq Level Lo" to Drive Fault and Alarm Types, Descriptions, and Actions table.	324
Updated the tables in event 157 "DigIn Cfg B" and event 158 "DigIn Cfg C", both contained in the Drive Fault and Alarm Types, Descriptions, and Actions table, to include rows and columns for Emerg OvrRide conditions.	328
Updated the table in 158 "DigIn Cfg C", in the Drive Fault and Alarm Types, Descriptions, and Actions table, to include footnote to Forward and Reverse parameters to show they are not compatible with parameter 308 if it is set to "bipolar."	329
Added event 176 "Home Config" to Drive Fault and Alarm Types, Descriptions, and Actions table.	330
Added events 300 "Emer Ovr Act" and 301 "Emer Ovr Not Act" to Drive Fault and Alarm Types, Descriptions, and Actions table.	333
Updated Drive Fault and Alarm Cross Reference By Name table to include new fault events 34, 66, 68, 176, 300, and 301	337
Added Auto Clear column to Inverter Fault and Alarm Types, Descriptions, and Actions table.	340

Topic	Page
Added Auto Clear column to Converter Fault and Alarm Types, Descriptions, and Actions table.	345
Added Auto Clear column to I/O Fault and Alarm Types, Descriptions, and Actions table.	359
Added Connected Components Workbench™ programming option and universal feedback encoder (20-750-UFB-1) option to the Crane Set up with Encoder Feedback section of Appendix C.	458
Added Attention statement regarding the “adjust freq” portion of the bus regulator function in the Enter Desired Bus Regulation Data section of Appendix C.	478
Added timing options for Course Update Period in Appendix F: Integrated Motion on EtherNet/IP Application.	517
Added parameters 676 [Trq Ref A Stpt] and 681 [Trq Ref B Stpt] to the PowerFlex 755 Drive Parameter Numeric Order table in Appendix F: Integrated Motion on EtherNet/IP Application.	537
Added information for parameter 1100 [Trq Prove Cfg] Bits 3, 4, and 10 to the PowerFlex 755 Drive Parameter Numeric Order table in Appendix F: Integrated Motion on EtherNet/IP Application.	537
Updated Index with new parameters	547

## Product Certification

Product Certifications and Declarations of Conformity are available on the Internet at:

<http://www.rockwellautomation.com/global/certification/overview.page>.

## Manual Conventions

- In this manual we refer to PowerFlex 750-Series Adjustable Frequency AC Drives as: drive, PowerFlex 750, PowerFlex 750 drive, or PowerFlex 750 AC drive.
- Specific drives within the PowerFlex 750-Series can be referred to as:
  - PowerFlex 753, PowerFlex 753 drive, or PowerFlex 753 AC drive
  - PowerFlex 755, PowerFlex 755 drive, or PowerFlex 755 AC drive
- To help differentiate parameter names and LCD display text from other text, the following conventions are used.
  - Parameter names will appear in [brackets] after the parameter number.  
For example: parameter 308 [Direction Mode].
  - Display text appears in “quotes.” For example: “Enabled.”

## General Precautions

## Qualified Personnel

---



**ATTENTION:** Only qualified personnel familiar with adjustable frequency AC drives and associated machinery must plan or implement the installation, startup, and subsequent maintenance of the system. Failure to comply can result in personal injury and equipment damage.

---

## Personal Safety

---



**ATTENTION:** To avoid an electric shock hazard, verify that the voltage on the bus capacitors has discharged before servicing.

**Frames 1...7:** Measure the DC bus voltage at the power terminal block by measuring between the +DC and -DC terminals or between the +DC and -DC test point sockets if equipped. Also measure between the +DC terminal or test point and the chassis, and between the -DC terminal or testpoint and the chassis. The voltage must be zero for all three measurements.

**Frames 8...10:** Measure the DC bus voltage at the DC+ and DC- TESTPOINT sockets on the front of the power module.

See the PowerFlex 750-Series AC Drives Installation Instructions, publication [750-IN001](#), for terminal and testpoint socket locations.

---



**ATTENTION:** Hazard of personal injury or equipment damage exists when using bipolar input sources. Noise and drift in sensitive input circuits can cause unpredictable changes in motor speed and direction. Use speed command parameters to help reduce input source sensitivity.

**ATTENTION:** Risk of injury or equipment damage exists. DPI™ or SCANport™ host products must not be directly connected together via 1202 cables. Unpredictable behavior can result if two or more devices are connected in this manner.

**ATTENTION:** The drive start/stop/enable control circuitry includes Solid-state components. An additional hardwired stop circuit can be required to remove the AC line to the drive if either of the following hazards exist:

- Accidental contact with moving machinery
- Unintentional flow of liquid, gas, or solids

An auxiliary braking method can be required.

**ATTENTION:** Hazard of personal injury or equipment damage due to unexpected machine operation exists if the drive is configured to issue a Start or Run command automatically. Do not use these functions without considering applicable local, national, and international codes, standards, regulations, or industry guidelines.

---

---

## Product Safety

---



**ATTENTION:** An incorrectly applied or installed drive can result in component damage or a reduction in product life. Wiring or application errors such as under sizing the motor, incorrect or inadequate AC supply, or excessive surrounding air temperatures can result in malfunction of the system.

**ATTENTION:** This drive contains ESD (Electrostatic Discharge) sensitive parts and assemblies. Static control precautions are required when installing, testing, servicing or repairing this assembly. Component damage can result if ESD control procedures are not followed. If you are not familiar with static control procedures, reference Guarding Against Electrostatic Damage, publication 8000-4.5.2 or any other applicable ESD protection handbook.

**ATTENTION:** Configuring an analog input for 0...20 mA operation and driving it from a voltage source could cause component damage. Verify proper configuration before you apply input signals.

**ATTENTION:** A contactor or other device that routinely disconnects and reapplies the AC line to the drive to start and stop the motor can cause drive hardware damage. The drive is designed to use control input signals that start and stop the motor. If an input device is used, operation must not exceed 1 cycle per minute or drive damage can occur.

**ATTENTION:** Drive must not be installed in an area where the ambient atmosphere contains volatile or corrosive gas, vapors, or dust. If the drive is not going to be installed immediately, it must be stored in an area where it is not exposed to a corrosive atmosphere.

---

## Class 1 Light-emitting Diode Product

---



**ATTENTION:** Hazard of permanent eye damage exists when using optical transmission equipment. This product emits intense light and invisible radiation. Do not look into module ports or fiber-optic cable connectors.

---

## Additional Resources

The recommended documentation that is listed in this section is available online at <http://www.rockwellautomation.com/literature>.

The following publications provide general drive information.

Title	Publication
Wiring and Grounding Guidelines for Pulse Width Modulated (PWM) AC Drives	<a href="#">DRIVES-IN001</a>
Safety Guidelines for the Application, Installation, and Maintenance of Solid State Control	<a href="#">SGI-1.1</a>
Guarding Against Electrostatic Damage	<a href="#">8000-4.5.2</a>

The following publications provide specific PowerFlex 750-Series information on drive installation, features, specifications, and service.

Title	Publication
PowerFlex 750-Series AC Drive Installation Instructions	<a href="#">750-IN001</a>
PowerFlex 750-Series AC Drives Technical Data	<a href="#">750-TD001</a>
PowerFlex 20-HIM-A6 and 20-HIM-C6S HIM (Human Interface Module) User Manual	<a href="#">20HIM-UM001</a>
PowerFlex 750-Series Safe Torque Off User Manual	<a href="#">750-UM002</a>
Safe Speed Monitor Option Module for PowerFlex 750-Series AC Drives Reference Manual	<a href="#">750-RM001</a>
PowerFlex 755 Integrated Safety - Safe Torque Off Option Module User Manual	<a href="#">750-UM004</a>
PowerFlex 755/755T Integrated Safety Functions Option Module User Manual	<a href="#">750-UM005</a>
PowerFlex 750-Series AC Drives Hardware Service Manual (Frame 8 and Larger)	<a href="#">750-TG001</a>
Dynamic Braking Resistor Calculator	<a href="#">PFLEX-AT001</a>
DeviceLogix™ User Manual	<a href="#">RA-UM003</a>

The following publications provide specific Network Communications information.

Title	Publication
PowerFlex 755 Drive Embedded EtherNet/IP Adapter	<a href="#">750COM-UM001</a>
PowerFlex 750-Series Drive DeviceNet Option Module	<a href="#">750COM-UM002</a>
PowerFlex 20-750-CNETC Coaxial ControlNet Option Module	<a href="#">750COM-UM003</a>

The following publications provide necessary information when applying the Logix Processors.

Title	Publication
Logix5000™ Controllers Common Procedures	<a href="#">1756-PM001</a>
Logix5000 Controllers General Instructions	<a href="#">1756-RM003</a>
Logix5000 Controllers Process Control and Drives Instructions	<a href="#">1756-RM006</a>

The following publications provide information that is useful when planning and installing communication networks.

<b>Title</b>	<b>Publication</b>
ControlNet Coax Tap Installation Instructions	<a href="#">1786-IN007</a>
ControlNet Cable System Planning and Installation Manual	<a href="#">1786-6.2.1</a>
ControlNet Fiber Media Planning and Installation Guide	<a href="#">CNET-IN001</a>

To order paper copies of technical documentation, contact your local Allen-Bradley distributor or sales representative.

To find your local Allen-Bradley distributor, visit [www.rockwellautomation.com/locations](http://www.rockwellautomation.com/locations).

**Notes:**



## Startup

This chapter provides the information that is required to start up the PowerFlex® 750-Series drive.

Topic	Page
Start-Up Check List	17
Start-Up Menu	19
Drive Status Indicators	20
Establishing A Connection With EtherNet/IP	21

### Start-Up Check List

- This check list supports the Start-Up menu option.
- A Human Interface Module (HIM) is required to run the Start-Up routine.

For detailed information on by using the HIM, refer to the PowerFlex 20-HIM-A6 and 20-HIM-C6S HIM (Human Interface Module) User Manual, publication [20HIM-UM001](#).

- The Start-Up routine can modify parameter values for Analog and Digital I/O.

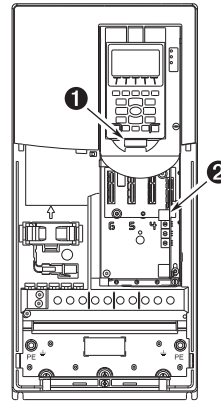


**ATTENTION:** Power must be applied to the drive to perform the following start-up procedure. Some of the voltages present are at incoming line potential. To avoid electric shock hazard or damage to equipment, it is recommended that only qualified service personnel perform the following procedure. Thoroughly read and understand the procedure before beginning.

### Prepare For Initial Drive Startup

- 1. Confirm that drive has been installed according to the PowerFlex 750-Series AC Drives Installation Instructions, publication [750-IN001](#).
- 2. Confirm that all inputs are connected to the correct terminals and are secure.
- 3. Verify that AC line power at the disconnect device is within the rated value of the drive.
- 4. Verify that control power voltage is correct.

- ❑ 5. Connect a Human Interface Module (HIM) to DPI™ Port 1 or 2 for the remainder of this procedure.



- ❑ 6. Apply AC power and control voltages to the drive.

**If any digital inputs are configured to Stop – CF, Run, or Enable, verify that signals are present or the drive does not start.** See [Chapter 6](#) for a list of potential digital input conflicts.

If the STS light-emitting diode is not flashing green, refer to Drive Status Indicators on page [20](#).


- ❑ 7. When prompted, select a display language. The Start-Up Screen automatically displays for drives that have not been previously configured.

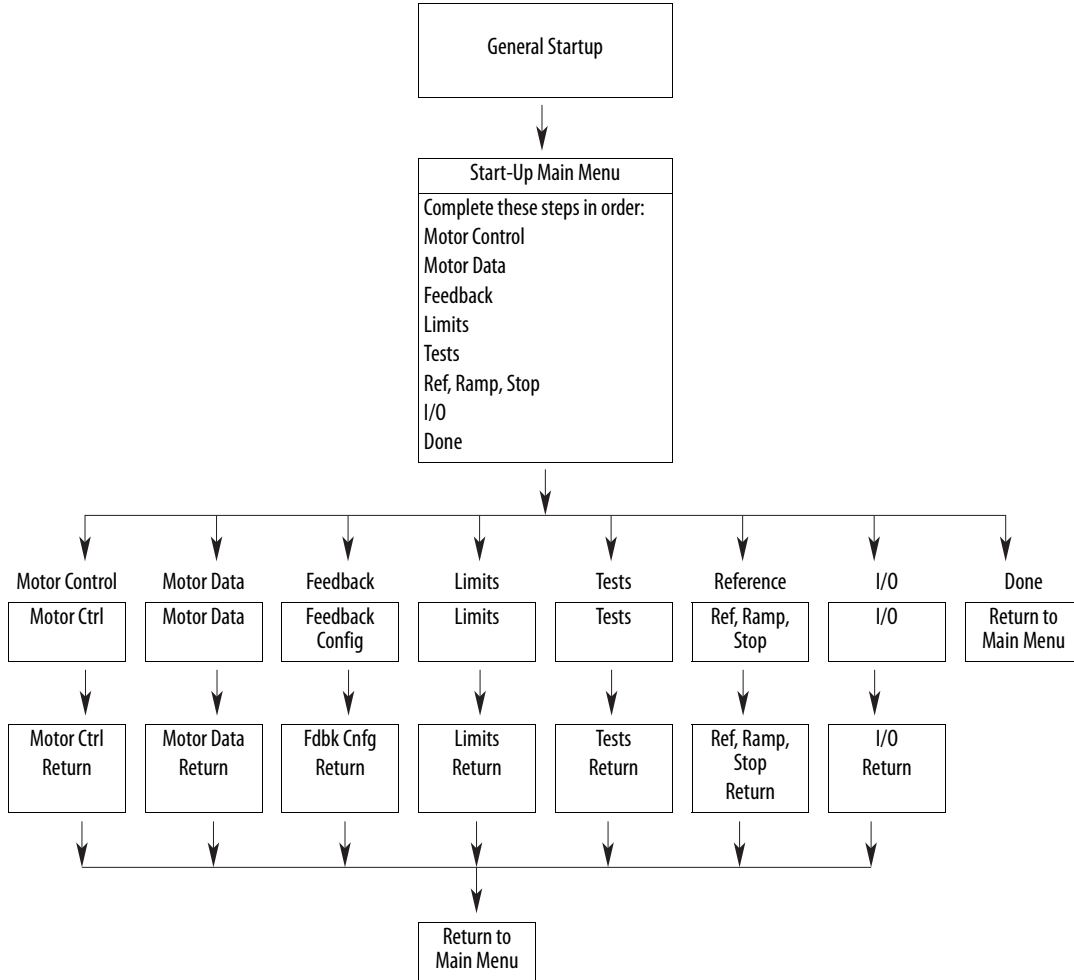
If the Start-Up screen is not displayed, press the Enter key.

- ❑ 8. Press the Enter key to display the Start-Up Menu.
- ❑ 9. Use the Up/Down Arrow keys to highlight “2. Basic.”
- ❑ 10. Press the Enter key. Follow the menu by using the Enter key, which steps you through the Start-Up routine.

The Start-Up routine asks simple questions and prompts you to input required information.

## Start-Up Menu

The Human Interface Module (HIM) displays the General Start-Up menu by default upon initial power-up of the drive. To navigate to the Start-Up menu after the initial powerup of the drive, press the  (Folders) key.




---

**IMPORTANT** If a start-up routine is initiated, but must be terminated before the routine is completed, be sure to press the Abort soft key to exit the routine.

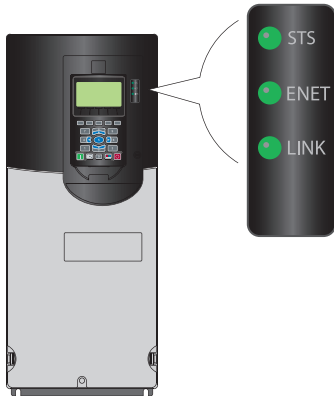
---

## Drive Status Indicators



**Table 1 - PowerFlex 753 Status Indicator Descriptions**

Name	Color	State	Description
STS (Status)	Green	Flashing	Drive ready but not running, and no faults are present.
		Steady	Drive running, no faults are present.
	Yellow	Flashing	Drive is not running, a start inhibit condition exists and the drive cannot be started. See parameter <a href="#">933</a> [Start Inhibits].
		Steady	A type 1 (user configurable) alarm exists. A stopped drive cannot start until the alarm condition is cleared. A running drive continues to run but cannot restart until the alarm condition is cleared. See parameters <a href="#">959</a> [Alarm Status A] and <a href="#">960</a> [Alarm Status B].
	Red	Flashing	A major fault has occurred. The drive stops and cannot be started until the fault condition is cleared. See parameter <a href="#">951</a> [Last Fault Code].
		Steady	A non-resettable fault has occurred.
	Red / Yellow	Flashing Alternately	A minor fault has occurred. When running, the drive continues to run. System is brought to a stop under system control. Fault must be cleared to continue. Use parameter <a href="#">950</a> [Minor Flt Cfg] to enable. If not enabled, acts like a major fault.
	Yellow / Green	Flashing Alternately	When running, a type 1 alarm exists. See parameters <a href="#">959</a> [Alarm Status A] and <a href="#">960</a> [Alarm Status B].
Green / Red	Flashing Alternately	Drive is flash updating.	



**Table 2 - PowerFlex 755 Status Indicator Descriptions**

Name	Color	State	Description
STS (Status)	Green	Flashing	Drive ready but not running, and no faults are present.
		Steady	Drive running, no faults are present.
	Yellow	Flashing	Drive is not running, a type 2 (non-configurable) alarm condition exists and the drive cannot be started. See parameter <a href="#">961</a> [Type 2 Alarms].
		Steady	A type 1 (user configurable) alarm exists. A stopped drive cannot start until the alarm condition is cleared. A running drive continues to run but cannot restart until the alarm condition is cleared. See parameters <a href="#">959</a> [Alarm Status A] and <a href="#">960</a> [Alarm Status B].
	Red	Flashing	A major fault has occurred. The drive stops and cannot be started until fault condition is cleared. See parameter <a href="#">951</a> [Last Fault Code].
		Steady	A non-resettable fault has occurred.
	Red / Yellow	Flashing Alternately	A minor fault has occurred. When running, the drive continues to run. System is brought to a stop under system control. Fault must be cleared to continue. Use parameter <a href="#">950</a> [Minor Flt Cfg] to enable. If not enabled, acts like a major fault.
	Yellow / Green	Flashing Alternately	When running, a type 1 alarm exists. See parameters <a href="#">959</a> [Alarm Status A] and <a href="#">960</a> [Alarm Status B].
Green / Red	Flashing Alternately	Drive is flash updating.	
ENET	Unlit	Off	Embedded EtherNet/IP is not properly connected to the network or needs an IP Address.
	Red	Flashing	An EtherNet/IP connection has timed out.
		Steady	Adapter failed the duplicate IP Address detection test.
	Red / Green	Flashing Alternately	Adapter is performing a self-test.
	Green	Flashing	Adapter is properly connected but is not communicating with any devices on the network.
Steady		Adapter is properly connected and communicating on the network.	
LINK	Unlit	Off	Adapter is not powered or is not transmitting on the network.
	Green	Flashing	Adapter is properly connected and transmitting data packets on the network.
		Steady	Adapter is properly connected but is not transmitting on the network.

---

**IMPORTANT** The Status Indicator light-emitting diodes on the HIM cradle do not indicate the status of an installed Communication Adapter option. If an optional Communication Adapter is installed, refer to the option module user manual for a description of light-emitting diode location and indication.

---

## Establishing A Connection With EtherNet/IP

There are three methods for configuring the embedded EtherNet/IP adapter IP address:

- **Adapter Rotary Switches** – Use the switches when working on a simple, isolated network (for example, 192.168.1.xxx) that has other products with switches to set their IP addresses, does not need to be accessed from outside the network, and you prefer a simplified node addressing method. The three adapter switches are read when the drive powers up, and represent three decimal digits from top to bottom (see [Figure 1](#)). If set to a valid address (001...254), the adapter uses that value as the lower octet of its IP address (192.168.1.xxx, where xxx = rotary switch settings), along with a subnet mask of 255.255.255.0 and there a gateway is not configured. Also, the setting for adapter P36 [BOOTP] is automatically ignored.

See [Figure 1](#) and its accompanying table for all possible switch settings and their related descriptions.

---

**IMPORTANT** When using the adapter rotary switches, set the IP address before power is applied because the adapter uses the IP address it detects when it first receives power.

---

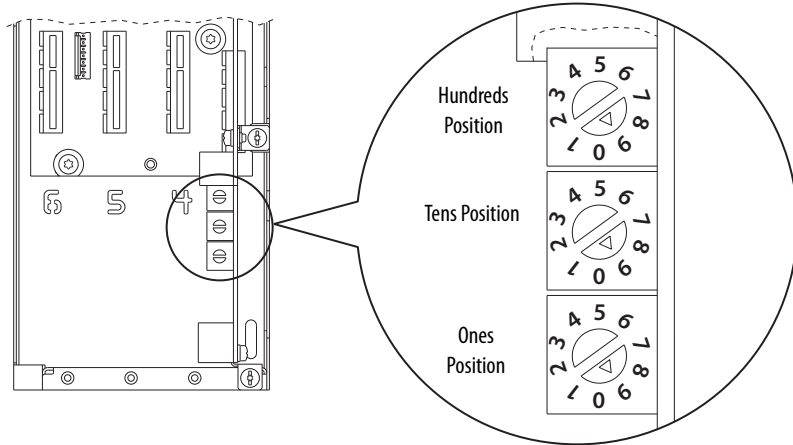
- **BOOTP Server** – Use BOOTP if you prefer to control the IP addresses of the devices by using a server. The IP address, subnet mask, and gateway addresses are provided by the BOOTP server.
- **Adapter Parameters** – Use adapter parameters when you want more flexibility in IP address configuration, or must communicate outside the control network by using a gateway. Use the adapter parameters to configure the IP address, subnet mask, and gateway addresses.

---

**IMPORTANT** Regardless of the method that is used to set the adapter IP address, each node on the EtherNet/IP network must have a unique IP address. To change an IP address, you must set the new value and then remove and reapply power to (or reset) the adapter.

---

**Figure 1 - Setting the IP Address Switches**



Possible Settings	Description
000	Adapter uses, depending on P36 [BOOTP], the BOOTP setting, or the adapter parameter settings for the IP address.
001...254	Adapter uses the rotary switch settings for the IP address (192.168.1.xxx, where xxx = rotary switch settings).
255...887	Adapter uses, depending on P36 [BOOTP], the BOOTP setting, or the adapter parameter settings for the IP address.
888	Resets the adapter IP address function to factory defaults. Thereafter, the drive must be powered down, the switches set to a setting other than 888, and then the drive must be powered up again to accept the new address.
889...998	Adapter uses, depending on P36 [BOOTP], the BOOTP setting, or the adapter parameter settings for the IP address.
999 (default settings)	Disables the rotary switches. Adapter uses, depending on P36 [BOOTP], the BOOTP setting, or the adapter parameter settings for the IP address.

## Parameter Organization

This chapter lists and describes the organization of the PowerFlex® 750-Series Port 0, Port 10, and Port 11 drive parameters. The parameters can be programmed (viewed/edited) using a Human Interface Module (HIM). Refer to Enhanced PowerFlex 20-HIM-A6 and 20-HIM-C6S HIM (Human Interface Module) User Manual, publication [20HIM-UM001](#), for information on using the HIM to view and edit parameters. As an alternative, programming can also be performed using DriveTools™ software and a personal computer.

<b>Topic</b>	<b>Page</b>
About Parameters	24
Parameter Access Level	25
How Drive Parameters are Organized	26
How Option Module Parameters are Organized	47





## About Parameters

To configure a drive module to operate in a specific way, certain drive parameters may have to be configured appropriately. Three types of parameters exist:





- Numeric Parameters**  
 These parameters have a single numeric value (such as 1750.0 RPM).
- ENUM Parameters**  
 These parameters allow a selection from 2 or more items. The LCD HIM displays a text message for each item.
- Indirect Parameters**  
 These parameters, represented by a maximum value of 159999 or 159999.15, are used to create assignments or to select either a data source or destination. The first two digits are used to select a port. The next four digits select a parameter number. If applicable, the two digits following the decimal point select a bit. For example, to assign an I/O option module in port 4 using a run contact on digital input 0, parameter 163 [DI Run] is set to 040001.00.
- Bit Parameters**  
 These parameters have individual bits associated with features or conditions. If the bit is 0, the feature is off or the condition is false. If the bit is 1, the feature is on or the condition is true.

Table 3 shows how each parameter type is presented in this manual.

Table 3 - Table Explanation

①	②	③	④	⑤																																																	
	No. Display Name Full Name Description	Values		Read-Write Data Type																																																	
MOTOR CONTROL	<b>28</b>  <b>Motor NP RPM</b> Motor Nameplate Revolutions Per Minute Rated RPM shown on the motor nameplate.	Units: RPM Default: 1750.0 Min/Max: 1.0 / 40000.0		RW Real																																																	
	<b>107</b>  <b>Trq Adapt En</b> Torque Adaption Enable Enables or disables the adaptive torque calculation. This selection is active only in motor control mode flux vector induction (P35 [Motor Ctrl Mode] = 3 "Induction FV").	Default: 1 = "Enabled" Options: 0 = "Disabled" 1 = "Enabled"		RW 32-bit Integer																																																	
FEEDBACK & I/O	<b>164</b>  <b>DI Run Forward</b> Digital Input Run Forward Assigns a digital input used to run the drive (2 wire control) and command forward direction.	Default: 0.00 Min/Max: 0.00 / 159999.15		RW 32-bit Integer																																																	
	<b>220</b>  <b>753 Digital In Sts</b> Digital Input Status Status of the digital inputs resident on the main control board (Port 0).  Options <table border="1" style="display: inline-table; vertical-align: top;"> <tr> <td></td> <td>Reserved</td><td>Reserved</td><td>Reserved</td><td>Reserved</td><td>Reserved</td><td>Reserved</td><td>Reserved</td><td>Reserved</td><td>Reserved</td><td>Reserved</td><td>Reserved</td><td>Reserved</td><td>Reserved</td><td>Digital In 2</td><td>Digital In 1</td><td>Digital In 0</td> </tr> <tr> <td>Default</td> <td>0</td><td>0</td><td>0</td><td>0</td><td>0</td><td>0</td><td>0</td><td>0</td><td>0</td><td>0</td><td>0</td><td>0</td><td>0</td><td>0</td><td>0</td><td>0</td> </tr> <tr> <td>Bit</td> <td>15</td><td>14</td><td>13</td><td>12</td><td>11</td><td>10</td><td>9</td><td>8</td><td>7</td><td>6</td><td>5</td><td>4</td><td>3</td><td>2</td><td>1</td><td>0</td> </tr> </table>		Reserved	Reserved	Reserved	Reserved	Reserved	Reserved	Reserved	Reserved	Reserved	Reserved	Reserved	Reserved	Reserved	Digital In 2	Digital In 1	Digital In 0	Default	0	0	0	0	0	0	0	0	0	0	0	0	0	0	0	0	Bit	15	14	13	12	11	10	9	8	7	6	5	4	3	2	1	0	0 = Condition False 1 = Condition True
	Reserved	Reserved	Reserved	Reserved	Reserved	Reserved	Reserved	Reserved	Reserved	Reserved	Reserved	Reserved	Reserved	Digital In 2	Digital In 1	Digital In 0																																					
Default	0	0	0	0	0	0	0	0	0	0	0	0	0	0	0	0																																					
Bit	15	14	13	12	11	10	9	8	7	6	5	4	3	2	1	0																																					



No.	Name Description	Read-Write	Data Type	
❶	File and Group organization			
	<b>No.</b> - Parameter Number			
	 Parameter value cannot be changed until the drive is stopped.			
	 Parameter cannot be set to DataLink In.			
❷	<b>Name</b> - Parameter name as it appears in the DriveExecutive™ software.			
	<b>Description</b> - Brief description of parameter function. The first line is the full text parameter name.			
	 = Parameter or option is specific to PowerFlex 753 drives only.			
	 = Parameter or option is specific to PowerFlex 755 drives only.			
❸	<b>755 (8+)</b> = Parameter or option is specific to PowerFlex 755 Frame 8 drives and larger only.			
	<b>Values</b> - Define the various operating characteristics of the parameter. <i>There are 3 types of Values.</i>			
	ENUM	Default:	Lists the value assigned at the factory.	
		Options:	Displays the selections available.	
	Bit	Default:	Lists the value assigned at the factory.	
		Options:	Displays the selections available.	
	Numeric	Default	Lists the value assigned at the factory.	
		Min/Max.	Displays lowest possible setting/Displays highest possible setting.	
	Indicates if parameter is read-write or read-only. <b>RW</b> = Read-Write <b>RO</b> = Read Only		RW RO	
	Indicates parameter data type (for example, integer, floating point, Boolean).			32-bit Integer

## Parameter Access Level

Three parameter access level options are selectable by P301 [Access Level].

- Option 0 “Basic” is the most limited view that only displays commonly utilized parameters and options.
- Option 1 “Advanced” is an expanded view that may be required to access more advanced drive features.
- Option 2 “Expert” provides a comprehensive view of the drive’s entire parameter set.

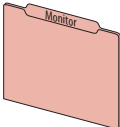
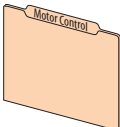

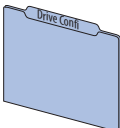
## How Drive Parameters are Organized

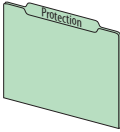
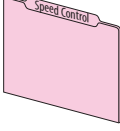
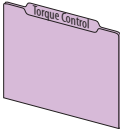
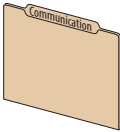
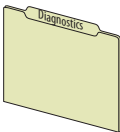
DriveExecutive programming software displays parameters in “Linear List” or “File Group Parameter” format. Viewing the parameters in “File Group Parameter” format simplifies programming by grouping parameters that are used for similar functions. There are eleven files. Each file is divided into multiple groups of parameters.

Drive (Port 0) parameter descriptions begin on [page 53](#).

### Basic Parameter View (Port 0)

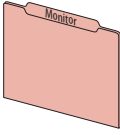
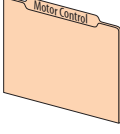

Parameter 301 [Access Level] set to option 0 “Basic.”

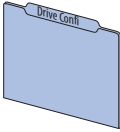
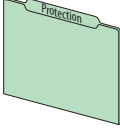
File	Group	Parameters							
	Metering	Output Frequency	1	Commanded Trq	4	Output Current	7	DC Bus Volts	11
		Commanded SpdRef	2	Torque Cur Fdbk	5	Output Voltage	8		
		Mtr Vel Fdbk	3	Flux Cur Fdbk	6	Output Power	9		
	Drive Data	Rated Volts	20	Rated Amps	21	Rated kW	22		
	Motor Data	Motor NP Volts	25	Motor NP Hertz	27	Mtr NP Pwr Units	29	Motor Poles	31
		Motor NP Amps	26	Motor NP RPM	28	Motor NP Power	30		
	Mtr Ctrl Options	Motor Ctrl Mode	35	Maximum Freq	37	PWM Frequency	38	IPM Stc Ofstst K <sup>(1)</sup>	1660
		Maximum Voltage	36					<sup>(1)</sup> Frames 1...7 Only	
	Volts per Hertz	VHz Curve	65						
Autotune	Autotune	70	IPM_Lg_50_pct	1631	IPM_Lg_100_pct	1633	IPM_Ld_0_pct	1635	
	Autotune Torque	71	IPM_Lg_75_pct	1632	IPM_Lg_125_pct	1634	IPM_Ld_100_pct	1636	
	IPM_Lg_25_pct	1630							
	Digin Functions	Digital In Cfg	150	DI Start	161	DI Jog 1 Reverse	168	DI Speed Sel 2	175
		DI Enable	155	DI Fwd Reverse	162	DI Jog 2	169	DI HOA Start	176
		DI Clear Fault	156	DI Run	163	DI Jog 2 Forward	170	DI Accel 2	179
		DI Aux Fault	157	DI Run Forward	164	DI Jog 2 Reverse	171	DI Decel 2	180
		DI Stop	158	DI Run Reverse	165	DI Manual Ctrl	172		
		DI Cur Lmt Stop	159	DI Jog 1	166	DI Speed Sel 0	173		
		DI Coast Stop	160	DI Jog 1 Forward	167	DI Speed Sel 1	174		
		Control Board IO <sup>755</sup>	Digital In Sts	220					
		Digital Inputs <sup>753</sup>	Digital In Sts	220	Dig In Filt Mask	222	Dig In Filt	223	
	Digital Outputs <sup>753</sup>	Dig Out Sts	225	R00 Level Sel	231	T00 Sel	240	T00 Level CmpSts	243
		Dig Out Invert	226	R00 Level	232	T00 Level Sel	241		
		R00 Sel	230	R00 Level CmpSts	233	T00 Level	242		
	Motor PTC <sup>753</sup>	PTC Cfg	250	PTC Status	251				
	Analog Inputs <sup>753</sup>	Anlg In Type	255	Anlg In0 Value	260	Anlg In0 Hi	261	Anlg In0 Lo	262
	Analog Outputs <sup>753</sup>	Anlg Out Type	270	Anlg Out0 Data	277	Anlg Out0 DataLo	279	Anlg Out0 Lo	281
Anlg Out0 Sel		275	Anlg Out0 DataHi	278	Anlg Out0 Hi	280	Anlg Out0 Val	282	
	Preferences	Speed Units	300	Access Level	301	Language	302		
	Control Cfg	Voltage Class	305	Duty Rating	306	Direction Mode	308	SpdTrqPsn Mode A	309
	Auto Manual Ctrl	Logic Mask	324	Manual Cmd Mask	326	Alt Man Ref Sel	328	Alt Man Ref AnLo	330
		Auto Mask	325	Manual Ref Mask	327	Alt Man Ref AnHi	329	Manual Preload	331
	Braking Features	Stop Mode A	370	Bus Reg Mode B	373	DB Ext Watts	384	Dec Inhibit Actn	409
		Stop Mode B	371	DB Resistor Type	382	DB ExtPulseWatts	385		
Bus Reg Mode A		372	DB Ext Ohms	383	Stop Dwell Time	392			

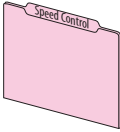
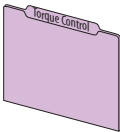
File	Group	Parameters								
	Motor Overload	Motor OL Actn	410	Mtr OL Alarm Lvl	412	Mtr OL Hertz	414	MtrOL Reset Time	416	
		Mtr OL at Pwr Up	411	Mtr OL Factor	413	Mtr OL Reset Lvl	415			
	Load Limits	Current Lmt Sel	421	Shear Pin Cfg	434	Shear Pin1 Level	436			
		Current Limit 1	422	Shear Pin 1 Actn	435	Shear Pin 1 Time	437			
	Power Loss	Power Loss Actn	449	Pwr Loss Mode A	450					
	Flt/Alarm Cfg	Dec Inhibit Actn	409	Shear Pin 1 Actn	435	Power Loss Actn	449	Minor Flt Cfg	950	
		Motor OL Actn	410							
		Speed Limits	Max Fwd Speed	520	Max Rev Speed	521	Min Fwd Speed	522	Min Rev Speed	523
		Speed Ramp Rates	Accel Time 1	535	Decel Time 1	537	Jog Acc Dec Time	539		
			Accel Time 2	536	Decel Time 2	538				
Speed Reference		Spd Ref A Sel	545	Spd Ref B Stpt	551	MOP Init Select	566	Preset Speed 4	574	
		Spd Ref A Stpt	546	Spd Ref B AnlgHi	552	MOP Init Stpt	567	Preset Speed 5	575	
		Spd Ref A AnlgHi	547	Spd Ref B AnlgLo	553	Preset Speed 1	571	Preset Speed 6	576	
		Spd Ref A AnlgLo	548	Jog Speed 1	556	Preset Speed 2	572	Preset Speed 7	577	
		Spd Ref B Sel	550	Jog Speed 2	557	Preset Speed 3	573			
		Torque Reference	Trq Ref A Sel	675	Trq Ref A AnlgLo	678	Trq Ref B Stpt	681	Trq Ref B Mult	684
	Trq Ref A Stpt		676	Trq Ref A Mult	679	Trq Ref B AnlgHi	682	Selected Trq Ref	685	
	Trq Ref A AnlgHi		677	Trq Ref B Sel	680	Trq Ref B AnlgLo	683			
	Comm Control	Port 1 Reference	871							
	DPI Datalinks	Data In A1	895	Data In C1	899	Data Out A1	905	Data Out C1	909	
		Data In A2	896	Data In C2	900	Data Out A2	906	Data Out C2	910	
		Data In B1	897	Data In D1	901	Data Out B1	907	Data Out D1	911	
		Data In B2	898	Data In D2	902	Data Out B2	908	Data Out D2	912	
	Status	Speed Ref Source	930	Last Stop Source	932	Last StrtInhibit	934	Drive Status 2	936	
		Last StartSource	931	Start Inhibits	933	Drive Status 1	935	Condition Sts 1	937	
	Fault/Alarm Info	Minor Flt Cfg	950	Last Fault Code	951	Fault Status A	952	Fault Status B	953	

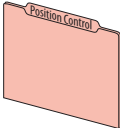
## Advanced Parameter View (Port 0)

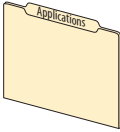
Parameter 301 [Access Level] set to option 1 “Advanced.”

File	Group	Parameters								
	Metering	Output Frequency	1	Flux Cur Fdbk	6	DC Bus Volts	11	Elpsd Mtr MWHrs	16	
		Commanded SpdRef	2	Output Current	7	DC Bus Memory	12	Elpsd Rgn MWHrs	17	
		Mtr Vel Fdbk	3	Output Voltage	8	Elapsed MWH	13	Elpsd Mtr kWhrs	18	
		Commanded Trq	4	Output Power	9	Elapsed kWh	14	Elpsd Rgn kWhrs	19	
		Torque Cur Fdbk	5	Output Powr Fctr	10	Elapsed Run Time	15	Fdbk Filter Cfg	303	
	Drive Data	Rated Volts	20	Rated Amps	21	Rated kW	22			
		Motor Data	Motor NP Volts	25	Motor NP Hertz	27	Mtr NP Pwr Units	29	Motor Poles	31
Motor NP Amps			26	Motor NP RPM	28	Motor NP Power	30			
Mtr Ctrl Options		Motor Ctrl Mode	35	Maximum Freq	37	Mtr Options Cfg	40	Flux Up Time	44	
		Maximum Voltage	36	PWM Frequency	38	Common Mode Type	41	IPM Stc Ofstst K <sup>(1)</sup>	1660	
						Flux Up Enable	43	<sup>(1)</sup> Frames 1 . . . 7 Only		
Volts per Hertz		Start Acc Boost	60	Break Voltage	62	VHz Curve	65			
		Run Boost	61	Break Frequency	63					
Autotune		Autotune	70	Flux Current Ref	75	IPM_Lg_50_pct	1631	IPM_Ld_0_pct	1635	
		Autotune Torque	71	Total Inertia	76	IPM_Lg_75_pct	1632	IPM_Ld_100_pct	1636	
		IR Voltage Drop	73	Inertia Test Lmt	77	IPM_Lg_100_pct	1633			
		Ixo Voltage Drop	74	IPM_Lg_25_pct	1630	IPM_Lg_125_pct	1634			
		Digin Functions	Digital In Cfg	150	DI Jog 1	166	DI MOP Dec	178	DI PID Hold	192
			DI Enable	155	DI Jog 1 Forward	167	DI Accel 2	179	DI PID Reset	193
	DI Clear Fault		156	DI Jog 1 Reverse	168	DI Decel 2	180	DI PID Invert	194	
	DI Aux Fault		157	DI Jog 2	169	DI SpTqPs Sel 0	181	DI Torque StptA	195	
	DI Stop		158	DI Jog 2 Forward	170	DI SpTqPs Sel 1	182	DI Fwd End Limit	196	
	DI Cur Lmt Stop		159	DI Jog 2 Reverse	171	DI Stop Mode B	185	DI Fwd Dec Limit	197	
	DI Coast Stop		160	DI Manual Ctrl	172	DI BusReg Mode B	186	DI Rev End Limit	198	
	DI Start		161	DI Speed Sel 0	173	DI PwrLoss ModeB	187	DI Rev Dec Limit	199	
	DI Fwd Reverse		162	DI Speed Sel 1	174	DI Pwr Loss	188	DI PHdwr OvrTrvl	200	
	DI Run		163	DI Speed Sel 2	175	DI Precharge	189	DI NHdwr OvrTrvl	201	
	DI Run Forward		164	DI HOA Start	176	DI Prchrg Seal	190			
	DI Run Reverse		165	DI MOP Inc	177	DI PID Enable	191			
	Control Board IO <sup>755</sup>		Digital In Sts	220						
	Digital Inputs <sup>753</sup>		Digital In Sts	220	Dig In Filt Mask	222	Dig In Filt	223		
	Digital Outputs <sup>753</sup>		Dig Out Sts	225	R00 Level Sel	231	R00 Off Time	235	T00 Level CmpSts	243
		Dig Out Invert	226	R00 Level	232	T00 Sel	240	T00 On Time	244	
		Dig Out Setpoint	227	R00 Level CmpSts	233	T00 Level Sel	241	T00 Off Time	245	
		R00 Sel	230	R00 On Time	234	T00 Level	242			
	Motor PTC <sup>753</sup>	PTC Cfg	250	PTC Status	251					
	Analog Inputs <sup>753</sup>	Anlg In Type	255	Anlg In0 Value	260	Anlg In0 LssActn	263	Anlg In0 Filt BW	266	
		Anlg In Sqrt	256	Anlg In0 Hi	261	Anlg In0 Raw Val	264			
		Anlg In Loss Sts	257	Anlg In0 Lo	262	Anlg In0 Filt Gn	265			
	Analog Outputs <sup>753</sup>	Anlg Out Type	270	Anlg Out0 Stpt	276	Anlg Out0 DataLo	279	Anlg Out0 Val	282	
		Anlg Out Abs	271	Anlg Out0 Data	277	Anlg Out0 Hi	280			
		Anlg Out0 Sel	275	Anlg Out0 DataHi	278	Anlg Out0 Lo	281			
	R0 Predict Main <sup>753</sup>	RO PredMaint Sts	285	R00 Load Amps	287	R00 ElapsedLife	289	R00 LifeEvtntLvl	291	
		R00 Load Type	286	R00 TotalLife	288	R00 RemainLife	290	R00 LifeEvtntActn	292	

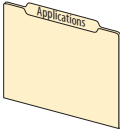
File	Group	Parameters		Parameters		Parameters		Parameters		
	Preferences	Speed Units	300	Access Level	301	Language	302			
	Control Cfg	Voltage Class	305	SpdTrqPsn Mode B	310	SLAT Err Stpt	314	Prchrg Err Cfg	323	
		Duty Rating	306	SpdTrqPsn Mode C	311	SLAT Dwell Time	315			
		Direction Mode	308	SpdTrqPsn Mode D	312	Prchrg Control	321			
		SpdTrqPsn Mode A	309	Actv SpTqPs Mode	313	Prchrg Delay	322			
	Auto Manual Ctrl	Logic Mask	324	Manual Cmd Mask	326	Alt Man Ref Sel	328	Alt Man Ref AnLo	330	
		Auto Mask	325	Manual Ref Mask	327	Alt Man Ref AnHi	329	Manual Preload	331	
	Drive Memory	Reset Meters	336							
	Start Features	AutoClrFlt Tries	338	PowerUp Delay	346	Sleep Wake Mode	350	Wake Level	354	
		AutoClrFlt Delay	339	Auto Retry Fault	347	SleepWake RefSel	351	Wake Time	355	
		AutoClrCntrDelay	340	Auto Rstrt Tries	348	Sleep Level	352	FlyingStart Mode	356	
		Rstrt Cntr Delay	343	Auto Rstrt Delay	349	Sleep Time	353	FS Brk Lvl	365	
		Start At PowerUp	345							
	Braking Features	Stop Mode A	370	Bus Reg Level	375	Flux Braking En	388	DC Brake Time	395	
		Stop Mode B	371	DB Resistor Type	382	Flux Braking Lmt	389	Brake Off Adj 1	402	
		Bus Reg Mode A	372	DB Ext Ohms	383	Stop Dwell Time	392	Brake Off Adj 2	403	
		Bus Reg Mode B	373	DB Ext Watts	384	DC Brake Lvl Sel	393	Dec Inhibit Actn	409	
		Bus Reg Lvl Cfg	374	DB ExtPulseWatts	385	DC Brake Level	394			
	Motor Overload	Motor OL Actn	410	Mtr OL Factor	413	Mtr OL Reset Lvl	415	Mtr OL Counts	418	
		Mtr OL at Pwr Up	411	Mtr OL Hertz	414	MtrOL Reset Time	416	Mtr OL Trip Time	419	
		Mtr OL Alarm Lvl	412							
	Load Limits	Drive OL Mode	420	Current Rate Lmt	425	Shear Pin1 Level	436	Load Loss Action	441	
		Current Lmt Sel	421	Regen Power Lmt	426	Shear Pin 1 Time	437	Load Loss Level	442	
		Current Limit 1	422	Motor Power Lmt	427	Shear Pin 2 Actn	438	Load Loss Time	443	
		Current Limit 2	423	Shear Pin Cfg	434	Shear Pin2 Level	439	OutPhaseLossActn	444	
		Active Cur Lmt	424	Shear Pin 1 Actn	435	Shear Pin 2 Time	440	Out PhaseLossLvl	445	
	Power Loss	Power Loss Actn	449	Pwr Loss A Time	452	Pwr Loss B Time	455	InPhase LossActn	462	
		Pwr Loss Mode A	450	Pwr Loss Mode B	453	UnderVltg Action	460	InPhase Loss Lvl	463	
		Pwr Loss A Level	451	Pwr Loss B Level	454	UnderVltg Level	461	DC Bus Mem Reset	464	
	Ground Fault	Ground Warn Actn	466	Ground Warn Lvl	467					
	Flt/Alarm Cfg	AutoClrFlt Tries	338	Auto Retry Fault	347	Motor OL Actn	410	Power Loss Actn	449	
		AutoClrFlt Delay	339	Auto Rstrt Tries	348	Shear Pin 1 Actn	435	InPhase LossActn	462	
		AutoClrCntrDelay	340	Auto Rstrt Delay	349	Shear Pin 2 Actn	438	Ground Warn Actn	466	
		Rstrt Cntr Delay	343	Dec Inhibit Actn	409	OutPhaseLossActn	444	Minor Flt Cfg	950	
	Predictive Main	PredMaint Sts	469	HSFan TotalLife	489	InFan EventLevel	499	MtrLubeEventActn	510	
		PredMaintAmbTemp	470	HSFan ElpsdLife	490	InFan EventActn	500	MchBrngTotalLife	511	
		PredMaint Rst En	471	HSFan RemainLife	491	InFan ResetLog	501	MchBrngElpsdLife	512	
PredMaint Reset		472	HSFan EventLevel	492	MtrBrngTotalLife	502	MchBrngRemainLif	513		
CbFan Derate <sup>755 (8+)</sup>		481	HSFan EventActn	493	MtrBrngElpsdLife	503	MchBrngEventLvl	514		
CbFan TotalLife <sup>755 (8+)</sup>		482	HSFan ResetLog <sup>(1)</sup>	494	MtrBrngRemainLif	504	MchBrngEventActn	515		
CbFan ElpsdLife <sup>755 (8+)</sup>		483	InFan Derate	495	MtrBrngEventLvl	505	MchBrngResetLog	516		
CbFan RemainLife <sup>755 (8+)</sup>		484	InFan TotalLife	496	MtrBrngEventActn	506	MchLubeElpsdHrs	517		
CbFan EventLevel <sup>755 (8+)</sup>		485	InFan ElpsdLife	497	MtrBrng ResetLog	507	MchLube EventLvl	518		
CbFan EventActn <sup>755 (8+)</sup>		486	InFan RemainLife	498	MtrLubeElpsdHrs	508	MchLubeEventActn	519		
HSFan Derate	488	<sup>(1)</sup> 755 Frames 1...7 only.		MtrLubeEventLvl	509					
Emergency Override	DI EmergencyOVRD	1680	Purge Frequency	1682	EmergMode Status	1684				
	Emerg OVRD Mode	1681	Emerg Prot OVRD	1683						

File	Group	Parameters		Parameters		Parameters		Parameters	
	Speed Limits	Max Fwd Speed	520	Min Rev Speed	523	Skip Speed 1	526	Skip Speed Band	529
		Max Rev Speed	521	Overspeed Limit	524	Skip Speed 2	527		
		Min Fwd Speed	522	Zero Speed Limit	525	Skip Speed 3	528		
	Speed Ramp Rates	Accel Time 1	535	Decel Time 1	537	Jog Acc Dec Time	539	S-curve Decel	541
		Accel Time 2	536	Decel Time 2	538	S-curve Accel	540		
	Speed Reference	Spd Ref A Sel	545	Spd Ref B AnlgLo	553	MOP High Limit	561	Preset Speed 1	571
		Spd Ref A Stpt	546	Spd Ref B Mult	554	MOP Low Limit	562	Preset Speed 2	572
		Spd Ref A AnlgHi	547	Spd Ref Scale	555	MOP Init Select	566	Preset Speed 3	573
		Spd Ref A AnlgLo	548	Jog Speed 1	556	MOP Init Stpt	567	Preset Speed 4	574
		Spd Ref A Mult	549	Jog Speed 2	557	DI ManRef Sel	563	Preset Speed 5	575
		Spd Ref B Sel	550	MOP Reference	558	DI ManRef AnlgHi	564	Preset Speed 6	576
		Spd Ref B Stpt	551	Save MOP Ref	559	DI ManRef AnlgLo	565	Preset Speed 7	577
		Spd Ref B AnlgHi	552	MOP Rate	560				
	Speed Trim	Trim Ref A Sel	600	Trim Ref B Sel	604	TrmPct RefA Sel	608	TrmPct RefB Sel	612
		Trim Ref A Stpt	601	Trim Ref B Stpt	605	TrmPct RefA Stpt	609	TrmPct RefB Stpt	613
		Trim RefA AnlgHi	602	Trim RefB AnlgHi	606	TrmPct RefA AnHi	610	TrmPct RefB AnHi	614
		Trim RefA AnlgLo	603	Trim RefB AnlgLo	607	TrmPct RefA AnLo	611	TrmPct RefB AnLo	615
	Slip/Droop Comp	Droop RPM at FLA	620	Slip RPM at FLA	621	Slip Comp BW	622		
	Speed Regulator	Spd Options Ctrl	635	Speed Reg Kp	645	Spd Reg Int Out	654	VHzSV Spd Reg Kp	663
		Speed Reg BW	636	Speed Reg Max Kp	646	Spd Reg Pos Lmt	655	VHzSV Spd Reg Ki	664
		Filtered SpdFdbk	640	Speed Reg Ki	647	Spd Reg Neg Lmt	656		
Speed Error		641	Spd Loop Damping	653	SReg Output	660			
Speed Comp	Speed Comp Sel	665	Speed Comp Gain	666	Speed Comp Out	667			
	Torque Limits	Pos Torque Limit	670	Neg Torque Limit	671				
	Torque Reference	Trq Ref A Sel	675	Trq Ref A Mult	679	Trq Ref B AnlgLo	683	Filtered Trq Ref	689
		Trq Ref A Stpt	676	Trq Ref B Sel	680	Trq Ref B Mult	684	Limited Trq Ref	690
		Trq Ref A AnlgHi	677	Trq Ref B Stpt	681	Selected Trq Ref	685		
		Trq Ref A AnlgLo	678	Trq Ref B AnlgHi	682	Torque Step	686		
	Inertia Comp <sup>755</sup>	Inertia CompMode	695	Inertia Dec Gain	697	Inertia Comp Out	699		
		Inertia Acc Gain	696	Inert Comp LPFBW	698	Ext Ramped Ref	700		
	Inertia Adaption <sup>755</sup>	InAdp LdObs Mode	704	InertiaAdaptGain	706	InertiaTrqAdd	708	InertAdptFltrBW	710
		Inertia Adapt BW	705	Load Estimate	707	IA LdObs Delay	709	Load Observer BW	711
	Friction Comp <sup>755</sup>	FrctnComp Mode	1560	FrctnComp Hyst	1562	FrctnComp Stick	1564	FrctnComp Rated	1566
		FrctnComp Trig	1561	FrctnComp Time	1563	FrctnComp Slip	1565	FrctnComp Out	1567

File	Group	Parameters		Parameters		Parameters		Parameters	
	Position Cfg/Sts	PTP PsnRefStatus	720	Psn Selected Ref	722	Psn Reg Status	724	In Pos Psn Band	726
		Position Control	721	Psn Command	723	Zero Position	725	In Pos Psn Dwell	727
	Position Homing	Homing Status	730	DI OL Home Limit	734	User Home Psn	738	Home Trq Offset	742
		Homing Control	731	Find Home Speed	735	Home Trq Thresh	739	Home Return Spd	743
		DI Find Home	732	Find Home Ramp	736	Home Trq Time	740	Home Decel	744
		DI Redefine Psn	733	Actual Home Psn	737	Home Trq Level	741		
	Position Watch <sup>755</sup>	PsnWatch1 Select	745	PsnWatch1 Stpt	747	PsnWatch2 DtctlIn	749		
		PsnWatch1 DtctlIn	746	PsnWatch2 Select	748	PsnWatch2 Stpt	750		
	Interpolator <sup>755</sup>	Interp Control	755	Interp Vel Input	757	Interp Psn Out	759	Interp Trq Out	761
		Interp Psn Input	756	Interp Trq Input	758	Interp Vel Out	760		
	Direct	Psn Ref Select	765	Psn Direct Stpt	766	Psn Direct Ref	767		
	Point to Point	PTP Control	770	PTP Reference	776	PTP Decel Time	782	PTP Vel Override	788
		PTP Mode	771	PTP Feedback	777	PTP Speed FwdRef	783	PTP EGR Mult	789
		DI Indx Step	772	PTP Ref Scale	778	PTP Command	784	PTP EGR Div	790
		DI Indx StepRev	773	PTP Index Preset	779	PTP Fwd Vel Lmt	785		
		DI Indx StepPrst	774	PTP Setpoint	780	PTP Rev Vel Lmt	786		
		PTP Ref Sel	775	PTP Accel Time	781	PTP S-curve	787		
	Phase Lock Loop <sup>755</sup>	PLL Control	795	PLL Psn Stpt	800	PLL Rvls Input	805	PLL Enc Out Adv	810
		PLL Ext Spd Sel	796	PLL BW	801	PLL Psn Out Fitr	806	PLL EPR Output	811
		PLL Ext Spd Stpt	797	PLL LPFilter BW	802	PLL Speed Out	807	PLL Rvls Output	812
		PLL Ext SpdScale	798	PLL Virt Enc RPM	803	PLL Speed OutAdv	808		
		PLL Psn Ref Sel	799	PLL EPR Input	804	PLL Enc Out	809		
	Electronic Gear	Psn Ref EGR Out	815	Psn EGR Mult	816	Psn EGR Div	817		
	Position Offset	Psn Offset 1 Sel	820	Psn Offset 2 Sel	822	Psn Offset Vel	824		
Psn Offset 1		821	Psn Offset 2	823					
Ld Psn Fdbk Scal <sup>755</sup>	LdPsn Fdbk Mult	825	LdPsn Fdbk Div	826					
Position Reg	Psn Error	835	Psn Reg Kp	839	PsnReg Spd Out	843	Psn Fdbk	847	
	Psn Actual	836	PReg Pos Int Lmt	840	PReg Pos Spd Lmt	844	Psn Gear Ratio	848	
	Psn Load Actual <sup>755</sup>	837	PReg Neg Int Lmt	841	PReg Neg Spd Lmt	845			
	Psn Reg Ki	838	PsnReg IntgrlOut	842	Psn Reg Droop	846			
Communication	Comm Control	Port 1 Reference	871	Port 5 Reference	875	Drive Logic Rslt	879	Drive Ref Rslt	883
		Port 2 Reference	872	Port 6 Reference	876	DPI Ref Rslt	880	Drive Ramp Rslt	884
		Port 3 Reference	873	Port13 Reference <sup>755</sup>	877	DPI Ramp Rslt	881		
		Port 4 Reference	874	Port14 Reference	878	DPI Logic Rslt	882		
	Security	Port Mask Act	885	Logic Mask Act	886	Write Mask Act	887	Write Mask Cfg	888
DPI Datalinks	Data In A1	895	Data In C1	899	Data Out A1	905	Data Out C1	909	
	Data In A2	896	Data In C2	900	Data Out A2	906	Data Out C2	910	
	Data In B1	897	Data In D1	901	Data Out B1	907	Data Out D1	911	
	Data In B2	898	Data In D2	902	Data Out B2	908	Data Out D2	912	
Owners	Stop Owner	919	Jog Owner	921	Clear Flt Owner	923	Ref Select Owner	925	
	Start Owner	920	Dir Owner	922	Manual Owner	924			
Diagnostics	Status	Speed Ref Source	930	Last StrtlInhibit	934	Drive OL Count	940	Drive Temp C	944
		Last StartSource	931	Drive Status 1	935	IGBT Temp Pct	941	At Limit Status	945
		Last Stop Source	932	Drive Status 2	936	IGBT Temp C	942	Safety Port Sts	946
		Start Inhibits	933	Condition Sts 1	937	Drive Temp Pct	943		
	Fault/Alarm Info	Minor Flt Cfg	950	Status1 at Fault	954	Fault Bus Volts	958	AlarmA at Fault	962
		Last Fault Code	951	Status2 at Fault	955	Alarm Status A	959	AlarmB at Fault	963
		Fault Status A	952	Fault Frequency	956	Alarm Status B	960		
		Fault Status B	953	Fault Amps	957	Type 2 Alarms	961		
	Peak Detection <sup>755</sup>	PkDtct Stpt Real	1035	PkDtct1PresetSel	1038	PeakDetect1 Out	1041	Peak2 Cfg	1044
		PkDtct Stpt DInt	1036	Peak1 Cfg	1039	PkDtct2 In Sel	1042	Peak 2 Change	1045
		PkDtct1 In Sel	1037	Peak 1 Change	1040	PkDtct2PresetSel	1043	PeakDetect2 Out	1046

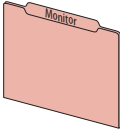
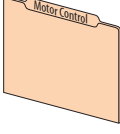
File	Group	Parameters							
<b>Applications</b> 	Process PID	PID Cfg	1065	PID Fdbk AnlgHi	1073	PID Upper Limit	1081	PID Status	1089
		PID Control	1066	PID Fdbk AnlgLo	1074	PID Lower Limit	1082	PID Ref Meter	1090
		PID Ref Sel	1067	PID FBLoss SpSel	1075	PID Deadband	1083	PID Fdbk Meter	1091
		PID Ref AnlgHi	1068	PID FBLoss TqSel	1076	PID LP Filter BW	1084	PID Error Meter	1092
		PID Ref AnlgLo	1069	PID Fdbk	1077	PID Preload	1085	PID Output Meter	1093
		PID Setpoint	1070	PID Fdbk Mult	1078	PID Prop Gain	1086		
		PID Ref Mult	1071	PID Output Sel	1079	PID Int Time	1087		
		PID Fdbk Sel	1072	PID Output Mult	1080	PID Deriv Time	1088		
	Torque Prove <sup>755</sup>	Trq Prove Cfg	1100	Trq Lmt SlewRate	1104	Brk Set Time	1108	MicroPsnScalePct	1112
		Trq Prove Setup	1101	Speed Dev Band	1105	Brk Alarm Travel	1109	ZeroSpdFloatTime	1113
		DI FloatMicroPsn	1102	SpdBand Intgrtr	1106	Brk Slip Count	1110	Brake Test Torq <sup>755</sup>	1114
		Trq Prove Status	1103	Brk Release Time	1107	Float Tolerance	1111		
	Fibers Function	Fiber Control	1120	Traverse Inc	1123	P Jump	1126		
		Fiber Status	1121	Traverse Dec	1124	DI Fiber SyncEna	1129		
		Sync Time	1122	Max Traverse	1125	DI Fiber TravDis	1130		
	Adjustable Vltg	Adj Vltg Config	1131	Adj Vltg Trim Lo	1138	Adj Vltg Preset3	1144	Adj Vltg Scurve	1150
		Adj Vltg Select	1133	Adj Vltg Command	1139	Adj Vltg Preset4	1145	Adj Vltg TrimPct	1151
		Adj Vltg Ref Hi	1134	Adj Vltg AccTime	1140	Adj Vltg Preset5	1146	Min Adj Voltage	1152
		Adj Vltg Ref Lo	1135	Adj Vltg DecTime	1141	Adj Vltg Preset6	1147	Dead Time Comp	1153
		Adj Vltg TrimSel	1136	Adj Vltg Preset1	1142	Adj Vltg Preset7	1148	DC Offset Ctrl	1154
		Adj Vltg Trim Hi	1137	Adj Vltg Preset2	1143	Adj Vltg RefMult	1149		
	Pump Jack	Rod Speed	1165	TorqAlarm Dwell	1170	Max Rod Speed	1175	PCP Pump Sheave	1180
		Rod Torque	1166	TorqAlarm Level	1171	Max Rod Torque	1176	Gearbox Limit	1181
		Rod Speed Cmd	1167	TorqAlm Timeout	1172	Min Rod Speed	1177	Gearbox Rating	1182
		TorqAlarm Action	1168	TorqAlarm TOActn	1173	Motor Sheave	1178	Gearbox Ratio	1183
		TorqAlarm Config	1169	Total Gear Ratio	1174	OilWell Pump Cfg	1179	Gearbox Sheave	1184
	Pump Off	Pump Off Config	1187	Set Top ofStroke	1193	Lift Torque	1199	Day Stroke Count	1205
		Pump Off Setup	1188	Torque Setpoint	1194	Pct Drop Torque	1200	DI PumpOff Disbl	1206
Pump Off Action		1189	Pump Off Level	1195	Stroke Pos Count	1201	Pump OffSleepLvl	1207	
Pump Off Control		1190	Pump Off Speed	1196	Stroke Per Min	1202	DI Pump Baseline	1208	
Pump Off Status		1191	Pump Off Time	1197	Pump Off Count	1203			
Pump Cycle Store		1192	Pct Cycle Torque	1198	PumpOff SleepCnt	1204			



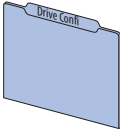
File	Group	Parameters						
<b>Applications</b> 	Profiling <sup>755</sup>	Profile Status	1210	DI StrtStep Sel0	1222	Step 1, 2, 3...16 Type	1230, 1240, 1250...1380	
		Units Traveled	1212	DI StrtStep Sel1	1223	Step 1, 2, 3...16 Velocity	1231, 1241, 1251...1381	
		Profile Command	1213	DI StrtStep Sel2	1224	Step 1, 2, 3...16 Accel	1232, 1242, 1252...1382	
		Counts Per Unit	1215	DI StrtStep Sel3	1225	Step 1, 2, 3...16 Decel	1233, 1243, 1253...1383	
		ProfVel Override	1216	DI StrtStep Sel4	1226	Step 1, 2, 3...16 Value	1234, 1244, 1254...1384	
		Prof DI Invert	1217			Step 1, 2, 3...16 Dwell	1235, 1245, 1255...1385	
		DI Hold Step	1218			Step 1, 2, 3...16 Batch	1236, 1246, 1256...1386	
		DI Abort Step	1219			Step 1, 2, 3...16 Next	1237, 1247, 1257...1387	
		DI Abort Profile	1220			Step 1, 2, 3...16 Action	1238, 1248, 1258...1388	
		DI Vel Override	1221			Step 1, 2, 3...16 Dig In	1239, 1249, 1259...1389	
Camming <sup>755</sup>	PCAM Control	1390	PCAM Scale X	1397	PCAM Main Pt X 0, 1, 2...15	1407, 1409, 1411...1437		
	PCAM Mode	1391	PCAM Span Y	1398	PCAM Main Pt Y 0, 1, 2...15	1408, 1410, 1412...1438		
	PCAM Psn Select	1392	PCAM ScaleY Sel	1399	PCAM Aux EndPnt	1439		
	PCAM Psn Stpt	1393	PCAM ScaleYSetPt	1400	PCAM Aux Types	1440		
	PCAM Psn Ofst	1394	PCAM VelScaleSel	1401	PCAM Aux Pt X 1, 2, 3...15	1441, 1443, 1445...1469		
	PCAM PsnOfst Eps	1395	PCAM VelScaleSP	1402	PCAM Aux Pt Y 1, 2, 3...15	1442, 1444, 1446...1470		
	PCAM Span X	1396	PCAM Slope Begin	1403	PCAM Status	1471		
			PCAM Slope End	1404	PCAM Vel Out	1472		
			PCAM Main EndPnt	1405	PCAM Psn Out	1473		
			PCAM Main Types	1406	DI PCAM Start	1474		
Roll Position <sup>755</sup>	Roll Psn Config	1500	Roll Psn Preset	1504	RP Rvls Output	1508	RP Unit Out	1512
	Roll Psn Status	1501	Roll Psn Offset	1505	RP Unwind	1509		
	RP Psn Fdbk Stpt	1502	RP EPR Input	1506	RP Unit Scale	1510		
	RP Psn Fdbk Sel	1503	RP Rvls Input	1507	RP Psn Output	1511		
Torque Boost <sup>755</sup>	PsnTrqBst Ctrl	1515	PsnTrqBst UNWCnt	1519	PsnTrqBst Ps X4	1523	PsnTrqBst Trq Y4	1527
	PsnTrqBst Sts	1516	PsnTrqBst Ps X1	1520	PsnTrqBst Ps X5	1524	PsnTrqBst TrqOut	1528
	PsnTrqBst RefSel	1517	PsnTrqBst Ps X2	1521	PsnTrqBst Trq Y2	1525		
	PsnTrqBstPsnOfst	1518	PsnTrqBst Ps X3	1522	PsnTrqBst Trq Y3	1526		
Variable Boost	VB Config	1535	VB Maximum	1540	VB Flux Thresh	1545	VB Cur Thresh	1550
	VB Status	1536	VB Accel Rate	1541	VB Flux Lag Freq	1546	VB Rate Lag Freq	1551
	VB Voltage	1537	VB Decel Rate	1542	VB Filt Flux Cur	1547		
	VB Time	1538	VB Frequency	1543	VB Current Rate	1548		
	VB Minimum	1539	VB Min Freq	1544	VB Current Hyst	1549		
Spindle Orient <sup>755</sup>	SO Config	1580	SO EPR Input	1584	SO Unit Scale	1588	SO Decel Time	1592
	SO Status	1581	SO Rvls Input	1585	SO Position Out	1589	SO Fwd Vel Lmt	1593
	SO Setpoint	1582	SO Rvls Output	1586	SO Unit Out	1590	SO Rev Vel Lmt	1594
	SO Offset	1583	SO Cnts per Rvls	1587	SO Accel Time	1591		
Id Compensation <sup>755</sup>	Id Comp Enbl	1600	Id Comp Mtrng 4	1607	IdCompRegen 1 lq	1614	Id Comp Regen 5	1621
	Id Comp Mtrng 1	1601	IdCompMtrng 4 lq	1608	Id Comp Regen 2	1615	IdCompRegen 5 lq	1622
	IdCompMtrng 1 lq	1602	Id Comp Mtrng 5	1609	IdCompRegen 2 lq	1616	Id Comp Regen 6	1623
	Id Comp Mtrng 2	1603	IdCompMtrng 5 lq	1610	Id Comp Regen 3	1617	IdCompRegen 6 lq	1624
	IdCompMtrng 2 lq	1604	Id Comp Mtrng 6	1611	IdCompRegen 3 lq	1618		
	Id Comp Mtrng 3	1605	IdCompMtrng 6 lq	1612	Id Comp Regen 4	1619		
	IdCompMtrng 3 lq	1606	Id Comp Regen 1	1613	IdCompRegen 4 lq	1620		

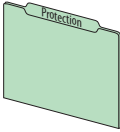
## Expert Parameter View (Port 0)

Parameter 301 [Access Level] set to option 2 “Expert.”

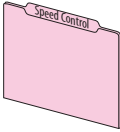
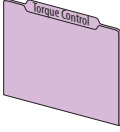
File	Group	Parameters								
<b>Monitor</b> 	Metering	Output Frequency	1	Flux Cur Fdbk	6	DC Bus Volts	11	Elpsd Mtr MWHrs	16	
		Commanded SpdRef	2	Output Current	7	DC Bus Memory	12	Elpsd Rgn MWHrs	17	
		Mtr Vel Fdbk	3	Output Voltage	8	Elapsed MWH	13	Elpsd Mtr kWhrs	18	
		Commanded Trq	4	Output Power	9	Elapsed kWh	14	Elpsd Rgn kWhrs	19	
		Torque Cur Fdbk	5	Output Powr Fctr	10	Elapsed Run Time	15	Fdbk Filter Cfg	303	
	Drive Data	Rated Volts	20	Rated Amps	21	Rated kW	22			
	<b>Motor Control</b> 	Motor Data	Motor NP Volts	25	Motor NP Hertz	27	Mtr NP Pwr Units	29	Motor Poles	31
			Motor NP Amps	26	Motor NP RPM	28	Motor NP Power	30		
		Mtr Ctrl Options	Motor Ctrl Mode	35	Flux Down Ki	45	IPM SpdEst Filt	1649	IPM Tran Filt Hi	1658
			Maximum Voltage	36	Flux Down Kp	46	IPM SpdEst Kp	1650	IPM Tran Angle	1659
Maximum Freq			37	Econ At Ref Ki	47	IPM SpdEst Ki	1651	IPM Stc OfstTst K	1660	
PWM Frequency			38	Econ AccDec Ki	48	IPM SpdEst KiAdj	1652	IPM Lq Cmd BW	1661	
Mtr Options Cfg			40	Econ AccDec Kp	49	IPM Tran PWM	1653	IPM SpdEst Kp Hi	1662	
Common Mode Type			41	Stability Filter	50	IPMTran PWM Hyst	1654			
Bus Utilization			42	Stab Volt Gain	51	IPM Tran Mode	1655	Parameters 1648...1662 used by drive frames 1...7 only.		
Flux Up Enable			43	Stab Angle Gain	52	IPM TranMod Hyst	1656			
Flux Up Time		44	IPM V FB HP Filt	1648	IPM Tran Filt Lo	1657				
Volts per Hertz		Start Acc Boost	60	Break Voltage	62	SVC Boost Filter	64			
		Run Boost	61	Break Frequency	63	VHz Curve	65			
Autotune		Autotune	70	EncdrLss VltComp	79	PM IR Voltage	87	IPM_Lg_50_pct	1631	
		Autotune Torque	71	PM Cfg	80	PM IXq Voltage <sup>755</sup>	88	IPM_Lg_75_pct	1632	
		IR Voltage Drop	73	PM PriEnc Offset	81	PM IXd Voltage <sup>755</sup>	89	IPM_Lg_100_pct	1633	
		Ixo Voltage Drop	74	PM AltEnc Offset	82	PM Vqs Reg Kp	91	IPM_Lg_125_pct	1634	
		Flux Current Ref	75	PM OfstTst Cur	83	PM Vqs Reg Ki	92	IPM_Ld_0_pct	1635	
		Total Inertia	76	PM OfstTst CRamp	84	PM Dir Test Cur	93	IPM_Ld_100_pct	1636	
		Inertia Test Lmt	77	PM OfstTst FRamp	85	PM IXqVoltage125	120	IPM PriOffstComp	1646	
	EncdrLss AngComp	78	PM CEMF Voltage	86	IPM_Lg_25_pct	1630	IPM AltOffstComp	1647		
Vector Regulator	VCL Cur Reg BW	95	Flux Reg Enable	103	Trq Comp Regen	111	IPMVqFFwdLldWe <sup>755</sup>	1638		
	VCL Cur Reg Kp	96	Flux Reg Ki	104	Slip Adapt Iqs	112	IPMVdFFwdLlqWe <sup>755</sup>	1639		
	VCL Cur Reg Ki	97	Flux Reg Kp	105	SFAdapt SlewLmt	113	IPM Max Cur <sup>755</sup>	1640		
	VEncdls FReg Kp	98	Trq Adapt Speed	106	SFAdapt SlewRate	114	PM Vel Max <sup>755</sup>	1641		
	VEncdls FReg Ki	99	Trq Adapt En	107	SFAdapt CnvrGvl	115	IPM TrqTrim Kp <sup>755</sup>	1642		
	Slip Reg Enable	100	Phase Delay Comp	108	SFAdapt CnvrGvLmt	116	IPM TrqTrim Ki <sup>755</sup>	1643		
	Slip Reg Ki	101	Trq Comp Mode	109	PM Bus Prot <sup>755</sup>	1629	IPM TrqTrim HLim <sup>755</sup>	1644		
	Slip Reg Kp	102	Trq Comp Mtring	110	IPMVqFFwdCemf <sup>755</sup>	1637	IPM TrqTrim LLim <sup>755</sup>	1645		

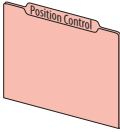

File	Group	Parameters								
	Feedback	Pri Vel Fdbk Sel	125	Alt Vel Feedback	130	Psn Fdbk Sel	135	Virtual EncDelay <sup>755</sup>	140	
		Pri Vel FdbkFltr	126	Active Vel Fdbk	131	Load Psn FdbkSel <sup>755</sup>	136	Virtual Enc EPR <sup>755</sup>	141	
		Pri Vel Feedback	127	Aux Vel Fdbk Sel	132	Open Loop Fdbk	137	Virtual Enc Psn <sup>755</sup>	142	
		Alt Vel Fdbk Sel	128	Aux Vel FdbkFltr	133	Simulator Fdbk	138			
		Alt Vel FdbkFltr	129	Aux Vel Feedback	134	Delayed Spd Ref <sup>755</sup>	139			
	Digin Functions	Digital In Cfg	150	DI Jog 1	166	DI MOP Dec	178	DI PID Hold	192	
		DI Enable	155	DI Jog 1 Forward	167	DI Accel 2	179	DI PID Reset	193	
		DI Clear Fault	156	DI Jog 1 Reverse	168	DI Decel 2	180	DI PID Invert	194	
		DI Aux Fault	157	DI Jog 2	169	DI SpTqPs Sel 0	181	DI Torque StptA	195	
		DI Stop	158	DI Jog 2 Forward	170	DI SpTqPs Sel 1	182	DI Fwd End Limit	196	
		DI Cur Lmt Stop	159	DI Jog 2 Reverse	171	DI Stop Mode B	185	DI Fwd Dec Limit	197	
		DI Coast Stop	160	DI Manual Ctrl	172	DI BusReg Mode B	186	DI Rev End Limit	198	
		DI Start	161	DI Speed Sel 0	173	DI PwrLoss ModeB	187	DI Rev Dec Limit	199	
		DI Fwd Reverse	162	DI Speed Sel 1	174	DI Pwr Loss	188	DI PHdwr OvrTrvl	200	
		DI Run	163	DI Speed Sel 2	175	DI Precharge	189	DI NHdwr OvrTrvl	201	
		DI Run Forward	164	DI HOA Start	176	DI Prchrg Seal	190			
		DI Run Reverse	165	DI MOP Inc	177	DI PID Enable	191			
		Control Board IO <sup>755</sup>	Digital In Sts	220						
		Digital Inputs <sup>753</sup>	Digital In Sts	220	Dig In Filt Mask	222	Dig In Filt	223		
	Digital Outputs <sup>753</sup>	Dig Out Sts	225	R00 Level Sel	231	R00 Off Time	235	T00 Level CmpSts	243	
Dig Out Invert		226	R00 Level	232	T00 Sel	240	T00 On Time	244		
Dig Out Setpoint		227	R00 Level CmpSts	233	T00 Level Sel	241	T00 Off Time	245		
R00 Sel		230	R00 On Time	234	T00 Level	242				
Motor PTC <sup>753</sup>	PTC Cfg	250	PTC Sts	251						
Analog Inputs <sup>753</sup>	Anlg In Type	255	Anlg In0 Value	260	Anlg In0 LssActn	263	Anlg In0 Filt BW	266		
	Anlg In Sqrt	256	Anlg In0 Hi	261	Anlg In0 Raw Val	264				
	Anlg In Loss Sts	257	Anlg In0 Lo	262	Anlg In0 Filt Gn	265				
Analog Outputs <sup>753</sup>	Anlg Out Type	270	Anlg Out0 Stpt	276	Anlg Out0 DataLo	279	Anlg Out0 Val	282		
	Anlg Out Abs	271	Anlg Out0 Data	277	Anlg Out0 Hi	280				
	Anlg Out0 Sel	275	Anlg Out0 DataHi	278	Anlg Out0 Lo	281				
R0 Predict Main <sup>753</sup>	R0 PredMaint Sts	285	R00 Load Amps	287	R00 ElapsedLife	289	R00 LifeEvtLvl	291		
	R00 Load Type	286	R00 TotalLife	288	R00 RemainLife	290	R00 LifeEvtActn	292		

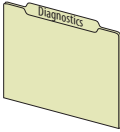
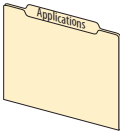
File	Group	Parameters		Parameters		Parameters		Parameters	
 <b>Drive Cfg</b>	Preferences	Speed Units	300	Access Level	301	Language	302		
	Control Cfg	Voltage Class	305	SpdTrqPsn Mode B	310	SLAT Err Stpt	314	Prchrg Err Cfg	323
		Duty Rating	306	SpdTrqPsn Mode C	311	SLAT Dwell Time	315		
		Direction Mode	308	SpdTrqPsn Mode D	312	Prchrg Control	321		
		SpdTrqPsn Mode A	309	Actv SpTqPs Mode	313	Prchrg Delay	322		
	Auto Manual Ctrl	Logic Mask	324	Manual Cmd Mask	326	Alt Man Ref Sel	328	Alt Man Ref AnLo	330
		Auto Mask	325	Manual Ref Mask	327	Alt Man Ref AnHi	329	Manual Preload	331
	Drive Memory	Reset Meters	336						
	Start Features	Start At PowerUp	345	SleepWake RefSel	351	FS Gain	357	FS Reconnect Dly	363
		PowerUp Delay	346	Sleep Level	352	FS Ki	358	FS Msmnt CurLvl	364
		Auto Retry Fault	347	Sleep Time	353	FS Speed Reg Ki	359	FS Brk Lvl	365
		Auto Rstrt Tries	348	Wake Level	354	FS Speed Reg Kp	360	FS Brk Time	366
		Auto Rstrt Delay	349	Wake Time	355	FS Excitation Ki	361	FS ZSpd Thresh	367
		Sleep Wake Mode	350	FlyingStart Mode	356	FS Excitation Kp	362		
	Braking Features	Stop Mode A	370	Bus Limit ACR Kp	379	Flux Braking Ki	390	DC Brk Vd Fltr	399
		Stop Mode B	371	Bus Reg Ki	380	Flux Braking Kp	391	Fast Braking Ki	400
		Bus Reg Mode A	372	Bus Reg Kp	381	Stop Dwell Time	392	Fast Braking Kp	401
		Bus Reg Mode B	373	DB Resistor Type	382	DC Brake Lvl Sel	393	Brake Off Adj 1	402
		Bus Reg Lvl Cfg	374	DB Ext Ohms	383	DC Brake Level	394	Brake Off Adj 2	403
		Bus Reg Level	375	DB Ext Watts	384	DC Brake Time	395	Dec Inhibit Actn	409
		Bus Limit Kp	376	DB ExtPulseWatts	385	DC Brake Ki	396		
		Bus Limit Kd	377	Flux Braking En	388	DC Brake Kp	397		
		Bus Limit ACR Ki	378	Flux Braking Lmt	389	DC Brk Vq Fltr	398		

File	Group	Parameters		Parameters		Parameters		Parameters	
	Motor Overload	Motor OL Actn	410	Mtr OL Factor	413	MtrOL Reset Time	416		
		Mtr OL at Pwr Up	411	Mtr OL Hertz	414	Mtr OL Counts	418		
		Mtr OL Alarm Lvl	412	Mtr OL Reset Lvl	415	Mtr OL Trip Time	419		
	Load Limits	Drive OL Mode	420	Motor Power Lmt	427	Shear Pin Cfg	434	Load Loss Action	441
		Current Lmt Sel	421	Current Limit Kd	428	Shear Pin 1 Actn	435	Load Loss Level	442
		Current Limit 1	422	Current Limit Ki	429	Shear Pin1 Level	436	Load Loss Time	443
		Current Limit 2	423	Current Limit Kp	430	Shear Pin 1 Time	437	OutPhaseLossActn	444
		Active Cur Lmt	424	Id Lo FreqCur Kp	431	Shear Pin 2 Actn	438	Out PhaseLossLvl	445
		Current Rate Lmt	425	Iq Lo FreqCur Kp	432	Shear Pin2 Level	439		
	Power Loss	Regen Power Lmt	426	Jerk Gain	433	Shear Pin 2 Time	440		
Power Loss Actn		449	Pwr Loss Mode B	453	PwrLoss RT BusKd	457	UnderVltg Level	461	
Pwr Loss Mode A		450	Pwr Loss B Level	454	PwrLoss RT ACRKp	458	InPhase LossActn	462	
Pwr Loss A Level		451	Pwr Loss B Time	455	PwrLoss RT ACRKi	459	InPhase Loss Lvl	463	
Ground Fault	Pwr Loss A Time	452	PwrLoss RT BusKp	456	UnderVltg Action	460	DC Bus Mem Reset	464	
	Ground Warn Actn	466	Ground Warn Lvl	467					
Flt/Alarm Cfg	AutoClrFlt Tries	338	Auto Retry Fault	347	Motor OL Actn	410	Power Loss Actn	449	
	AutoClrFlt Delay	339	Auto Rstrt Tries	348	Shear Pin 1 Actn	435	InPhase LossActn	462	
	AutoClrCntrDelay	340	Auto Rstrt Delay	349	Shear Pin 2 Actn	438	Ground Warn Actn	466	
	Rstrt Cntr Delay	343	Dec Inhibit Actn	409	OutPhaseLossActn	444	Minor Flt Cfg	950	
Predictive Main	PredMaint Sts	469	HSFan Derate	488	MtrBrngTotalLife	502	MchBrngTotalLife	511	
	PredMaintAmbTemp	470	HSFan TotalLife	489	MtrBrngElpsdLife	503	MchBrngElpsdLife	512	
	PredMaint Rst En	471	HSFan ElpsdLife	490	MtrBrngRemainLif	504	MchBrngRemainLif	513	
	PredMaint Reset	472	HSFan RemainLife	491	MtrBrngEventLvl	505	MchBrngEventLvl	514	
	CbFan Derate <sup>755 (8+)</sup>	481	HSFan EventLevel	492	MtrBrngEventActn	506	MchBrngEventActn	515	
	CbFan TotalLife <sup>755 (8+)</sup>	482	HSFan EventActn	493	MtrBrng ResetLog	507	MchBrngResetLog	516	
	CbFan ElpsdLife <sup>755 (8+)</sup>	483	HSFan ResetLog <sup>(1)</sup>	494	MtrLubeElpsdHrs	508	MchLubeElpsdHrs	517	
	CbFan RemainLife <sup>755 (8+)</sup>	484	InFan Derate	495	MtrLubeEventLvl	509	MchLube EventLvl	518	
	CbFan EventLevel <sup>755 (8+)</sup>	485	InFan TotalLife	496	MtrLubeEventActn	510	MchLubeEventActn	519	
	CbFan EventActn <sup>755 (8+)</sup>	486	InFan ElpsdLife	497					
Emergency Override			InFan RemainLife	498					
	DI EmergencyOVRD	1680	InFan EventLevel	499					
	Emerg OVRD Mode	1681	InFan EventActn	500					
			InFan ResetLog <sup>(1)</sup>	501					

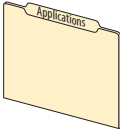
<sup>(1)</sup> 755 Frames 1...7 only.

File	Group	Parameters		Parameters		Parameters		Parameters		
	Speed Limits	Max Fwd Speed	520	Min Rev Speed	523	Skip Speed 1	526	Skip Speed Band	529	
		Max Rev Speed	521	Overspeed Limit	524	Skip Speed 2	527			
		Min Fwd Speed	522	Zero Speed Limit	525	Skip Speed 3	528			
	Speed Ramp Rates	Accel Time 1	535	Decel Time 1	537	Jog Acc Dec Time	539	S Curve Decel	541	
		Accel Time 2	536	Decel Time 2	538	S Curve Accel	540			
	Speed Reference	Spd Ref A Sel	545	Spd Ref Scale	555	DI ManRef AnlgLo	565	Spd Ref Filter	588	
		Spd Ref A Stpt	546	Jog Speed 1	556	MOP Init Select	566	Spd Ref Fltr BW	589	
		Spd Ref A AnlgHi	547	Jog Speed 2	557	MOP Init Stpt	567	Spd Ref FltrGain	590	
		Spd Ref A AnlgLo	548	MOP Reference	558	Preset Speed 1	571	Spd Ref Sel Sts	591	
		Spd Ref A Mult	549	Save MOP Ref	559	Preset Speed 2	572	Selected Spd Ref	592	
		Spd Ref B Sel	550	MOP Rate	560	Preset Speed 3	573	Limited Spd Ref	593	
		Spd Ref B Stpt	551	MOP High Limit	561	Preset Speed 4	574	Ramped Spd Ref	594	
		Spd Ref B AnlgHi	552	MOP Low Limit	562	Preset Speed 5	575	Filtered Spd Ref	595	
		Spd Ref B AnlgLo	553	DI ManRef Sel	563	Preset Speed 6	576	Speed Rate Ref	596	
		Spd Ref B Mult	554	DI ManRef AnlgHi	564	Preset Speed 7	577	Final Speed Ref	597	
		Speed Trim	Trim Ref A Sel	600	Trim Ref B Stpt	605	TrmPct RefA AnHi	610	TrmPct RefB AnLo	615
	Trim Ref A Stpt		601	Trim RefB AnlgHi	606	TrmPct RefA AnLo	611	SpdTrimPrcRefSrc	616	
	Trim RefA AnlgHi		602	Trim RefB AnlgLo	607	TrmPct RefB Sel	612	Spd Trim Source	617	
	Trim RefA AnlgLo		603	TrmPct RefA Sel	608	TrmPct RefB Stpt	613			
	Trim Ref B Sel		604	TrmPct RefA Stpt	609	TrmPct RefB AnHi	614			
	Slip/Droop Comp	Droop RPM at FLA	620	Slip RPM at FLA	621	Slip Comp BW	622	VHzSV SpdTrimReg	623	
	Speed Regulator	Spd Options Ctrl	635	SpdReg AntiBckup	643	AltSpdErr FltrBW	651	SReg OutFltr BW	659	
		Speed Reg BW	636	Spd Err Fltr BW	644	SReg Trq Preset	652	SReg Output	660	
		SReg FB Fltr Sel	637	Speed Reg Kp	645	Spd Loop Damping	653	VHzSV Spd Reg Kp	663	
		SReg FB FltrGain	638	Speed Reg Max Kp	646	Spd Reg Int Out	654	VHzSV Spd Reg Ki	664	
		SReg FB Fltr BW	639	Speed Reg Ki	647	Spd Reg Pos Lmt	655	Active Vel Fdbk	131	
		Filtered SpdFdbk	640	Alt Speed Reg BW	648	Spd Reg Neg Lmt	656			
		Speed Error	641	Alt Speed Reg Kp	649	SReg OutFltr Sel	657			
		Servo Lock Gain <sup>755</sup>	642	Alt Speed Reg Ki	650	SReg OutFltrGain	658			
	Speed Comp	Speed Comp Sel	665	Speed Comp Gain	666	Speed Comp Out	667			
		Torque Limits	Pos Torque Limit	670	Neg Torque Limit	671				
		Torque Reference	Trq Ref A Sel	675	Trq Ref A Mult	679	Trq Ref B AnlgLo	683	Notch Fltr Freq	687
			Trq Ref A Stpt	676	Trq Ref B Sel	680	Trq Ref B Mult	684	Notch Fltr Atten	688
			Trq Ref A AnlgHi	677	Trq Ref B Stpt	681	Selected Trq Ref	685	Filtered Trq Ref	689
			Trq Ref A AnlgLo	678	Trq Ref B AnlgHi	682	Torque Step	686	Limited Trq Ref	690
		Inertia Comp <sup>755</sup>	Inertia CompMode	695	Inertia Dec Gain	697	Inertia Comp Out	699		
			Inertia Acc Gain	696	Inert Comp LPFBW	698	Ext Ramped Ref	700		
		Inertia Adaption <sup>755</sup>	InAdp LdObs Mode	704	InertiaAdaptGain	706	InertiaTrqAdd	708	InertAdptFltrBW	710
			Inertia Adapt BW	705	Load Estimate	707	IA LdObs Delay	709	Load Observer BW	711
		Friction Comp <sup>755</sup>	FrctnComp Mode	1560	FrctnComp Hyst	1562	FrctnComp Stick	1564	FrctnComp Rated	1566
			FrctnComp Trig	1561	FrctnComp Time	1563	FrctnComp Slip	1565	FrctnComp Out	1567

File	Group	Parameters							
	Position Control	PTP PsnRefStatus	720	Psn Selected Ref	722	Psn Reg Status	724	In Pos Psn Band	726
		Position Control	721	Psn Command	723	Zero Position	725	In Pos Psn Dwell	727
	Position Homing	Homing Status	730	DI OL Home Limit	734	User Home Psn	738	Home Trq Offset	742
		Homing Control	731	Find Home Speed	735	Home Trq Thresh	739	Home Return Spd	743
		DI Find Home	732	Find Home Ramp	736	Home Trq Time	740	Home Decel	744
		DI Redefine Psn	733	Actual Home Psn	737	Home Trq Level	741		
	Position Watch <sup>755</sup>	PsnWatch1 Select	745	PsnWatch1 Stpt	747	PsnWatch2 DtctIn	749		
		PsnWatch1 DtctIn	746	PsnWatch2 Select	748	PsnWatch2 Stpt	750		
	Interpolator <sup>755</sup>	Interp Control	755	Interp Vel Input	757	Interp Psn Out	759	Interp Trq Out	761
		Interp Psn Input	756	Interp Trq Input	758	Interp Vel Out	760		
	Direct	Psn Ref Select	765	Psn Direct Stpt	766	Psn Direct Ref	767		
	Point to Point	PTP Control	770	PTP Reference	776	PTP Decel Time	782	PTP Vel Override	788
		PTP Mode	771	PTP Feedback	777	PTP Speed FwdRef	783	PTP EGR Mult	789
		DI Indx Step	772	PTP Ref Scale	778	PTP Command	784	PTP EGR Div	790
		DI Indx StepRev	773	PTP Index Preset	779	PTP Fwd Vel Lmt	785		
		DI Indx StepPrst	774	PTP Setpoint	780	PTP Rev Vel Lmt	786		
		PTP Ref Sel	775	PTP Accel Time	781	PTP S Curve	787		
	Phase Lock Loop <sup>755</sup>	PLL Control	795	PLL Psn Stpt	800	PLL Rvls Input	805	PLL Enc Out Adv	810
		PLL Ext Spd Sel	796	PLL BW	801	PLL Psn Out Fitr	806	PLL EPR Output	811
		PLL Ext Spd Stpt	797	PLL LPFilter BW	802	PLL Speed Out	807	PLL Rvls Output	812
		PLL Ext SpdScale	798	PLL Virt Enc RPM	803	PLL Speed OutAdv	808		
		PLL Psn Ref Sel	799	PLL EPR Input	804	PLL Enc Out	809		
	Electronic Gear	Psn Ref EGR Out	815	Psn EGR Mult	816	Psn EGR Div	817		
	Position Offset	Psn Offset 1 Sel	820	Psn Offset 2 Sel	822	Psn Offset Vel	824		
		Psn Offset 1	821	Psn Offset 2	823				
	Ld Psn Fdbk Scal <sup>755</sup>	LdPsn Fdbk Mult	825	LdPsn Fdbk Div	826				
	Position Reg	PsnNtchFltrFreq	830	Psn Error	835	PReg Pos Int Lmt	840	PReg Neg Spd Lmt	845
PsnNtchFltrDepth		831	Psn Actual	836	PReg Neg Int Lmt	841	Psn Reg Droop	846	
Psn Out Fitr Sel		832	Psn Load Actual <sup>755</sup>	837	PsnReg IntgrlOut	842	Psn Fdbk	847	
Psn Out FitrGain		833	Psn Reg Ki	838	PsnReg Spd Out	843	Psn Gear Ratio	848	
Psn Out Fitr BW		834	Psn Reg Kp	839	PReg Pos Spd Lmt	844			
	Comm Control	DPI Pt1 Flt Actn	865	DPI Pt3 Flt Ref	870	Port 5 Reference	875	DPI Ref Rslt	880
		DPI Pt2 Flt Actn	866	Port 1 Reference	871	Port 6 Reference	876	DPI Ramp Rslt	881
		DPI Pt3 Flt Actn	867	Port 2 Reference	872	Port13 Reference <sup>755</sup>	877	DPI Logic Rslt	882
		DPI Pt1 Flt Ref	868	Port 3 Reference	873	Port14 Reference	878	Drive Ref Rslt	883
		DPI Pt2 Flt Ref	869	Port 4 Reference	874	Drive Logic Rslt	879	Drive Ramp Rslt	884
	Security	Port Mask Act	885	Logic Mask Act	886	Write Mask Act	887	Write Mask Cfg	888
	DPI Datalinks	Data In A1	895	Data In C1	899	Data Out A1	905	Data Out C1	909
		Data In A2	896	Data In C2	900	Data Out A2	906	Data Out C2	910
		Data In B1	897	Data In D1	901	Data Out B1	907	Data Out D1	911
		Data In B2	898	Data In D2	902	Data Out B2	908	Data Out D2	912
	Owners	Stop Owner	919	Jog Owner	921	Clear Flt Owner	923	Ref Select Owner	925
		Start Owner	920	Dir Owner	922	Manual Owner	924		
	ODK Datalinks	UserData Int 00...31	1700...1731			ScaleBlk Sel 00...07	1900, 1904,...1928		
		UserData Real 00...31	1800...1831			ScaleBlk Scal 00...07	1901, 1905,...1929		
						ScaleBlk Int 00...07	1902, 1906,...1930		
						ScaleBlk Real 00...07	1903, 1907,...1931		

File	Group	Parameters							
 <b>Diagnostics</b>	Status	Speed Ref Source	930	Last StrtInhibit	934	Drive OL Count	940	Drive Temp C	944
		Last StartSource	931	Drive Status 1	935	IGBT Temp Pct	941	At Limit Status	945
		Last Stop Source	932	Drive Status 2	936	IGBT Temp C	942	Safety Port Sts	946
		Start Inhibits	933	Condition Sts 1	937	Drive Temp Pct	943		
	Fault/Alarm Info	Minor Flt Cfg	950	Status1 at Fault	954	Fault Bus Volts	958	AlarmA at Fault	962
		Last Fault Code	951	Status2 at Fault	955	Alarm Status A	959	AlarmB at Fault	963
		Fault Status A	952	Fault Frequency	956	Alarm Status B	960	MCB FPGA Actn	964
		Fault Status B	953	Fault Amps	957	Type 2 Alarms	961	Note: Parameter 964 <b>only applies</b> to PowerFlex 753.	
	Testpoints	Testpoint Sel 1	970	Testpoint Sel 2	974	Testpoint Sel 3	978	Testpoint Sel 4	982
		Testpoint Fval 1	971	Testpoint Fval 2	975	Testpoint Fval 3	979	Testpoint Fval 4	983
		Testpoint Lval 1	972	Testpoint Lval 2	976	Testpoint Lval 3	980	Testpoint Lval 4	984
	Peak Detection <sup>755</sup>	PKDtct Stpt Real	1035	PKDtct1PresetSel	1038	PeakDetect1 Out	1041	Peak2 Cfg	1044
		PKDtct Stpt DInt	1036	Peak1 Cfg	1039	PKDtct2 In Sel	1042	Peak 2 Change	1045
		PKDtct1 In Sel	1037	Peak 1 Change	1040	PKDtct2PresetSel	1043	PeakDetect2 Out	1046
	 <b>Applications</b>	Process PID	PID Cfg	1065	PID Fdbk AnlgHi	1073	PID Upper Limit	1081	PID Status
PID Control			1066	PID Fdbk AnlgLo	1074	PID Lower Limit	1082	PID Ref Meter	1090
PID Ref Sel			1067	PID FBloss SpSel	1075	PID Deadband	1083	PID Fdbk Meter	1091
PID Ref AnlgHi			1068	PID FBloss TqSel	1076	PID LP Filter BW	1084	PID Error Meter	1092
PID Ref AnlgLo			1069	PID Fdbk	1077	PID Preload	1085	PID Output Meter	1093
PID Setpoint			1070	PID Fdbk Mult	1078	PID Prop Gain	1086		
PID Ref Mult			1071	PID Output Sel	1079	PID Int Time	1087		
PID Fdbk Sel			1072	PID Output Mult	1080	PID Deriv Time	1088		
Torque Prove <sup>755</sup>		Trq Prove Cfg	1100	Trq Lmt SlewRate	1104	Brk Set Time	1108	MicroPsnScalePct	1112
		Trq Prove Setup	1101	Speed Dev Band	1105	Brk Alarm Travel	1109	ZeroSpdFloatTime	1113
		DI FloatMicroPsn	1102	SpdBand Intgrtr	1106	Brk Slip Count	1110	Brake Test Torq <sup>755</sup>	1114
		Trq Prove Status	1103	Brk Release Time	1107	Float Tolerance	1111		
Fibers Function		Fiber Control	1120	Traverse Inc	1123	P Jump	1126		
		Fiber Status	1121	Traverse Dec	1124	DI Fiber SyncEna	1129		
		Sync Time	1122	Max Traverse	1125	DI Fiber TravDis	1130		
Adjustable Vltg		Adj Vltg Config	1131	Adj Vltg Trim Lo	1138	Adj Vltg Preset3	1144	Adj Vltg Scurve	1150
		Adj Vltg Select	1133	Adj Vltg Command	1139	Adj Vltg Preset4	1145	Adj Vltg TrimPct	1151
		Adj Vltg Ref Hi	1134	Adj Vltg AccTime	1140	Adj Vltg Preset5	1146	Min Adj Voltage	1152
		Adj Vltg Ref Lo	1135	Adj Vltg DecTime	1141	Adj Vltg Preset6	1147	Dead Time Comp	1153
		Adj Vltg TrimSel	1136	Adj Vltg Preset1	1142	Adj Vltg Preset7	1148	DC Offset Ctrl	1154
		Adj Vltg Trim Hi	1137	Adj Vltg Preset2	1143	Adj Vltg RefMult	1149		
Pump Jack		Rod Speed	1165	TorqAlarm Dwell	1170	Max Rod Speed	1175	PCP Pump Sheave	1180
		Rod Torque	1166	TorqAlarm Level	1171	Max Rod Torque	1176	Gearbox Limit	1181
		Rod Speed Cmd	1167	TorqAlm Timeout	1172	Min Rod Speed	1177	Gearbox Rating	1182
		TorqAlarm Action	1168	TorqAlarm TOActn	1173	Motor Sheave	1178	Gearbox Ratio	1183
	TorqAlarm Config	1169	Total Gear Ratio	1174	OilWell Pump Cfg	1179	Gearbox Sheave	1184	
Pump Off	Pump Off Config	1187	Set Top ofStroke	1193	Pct Lift Torque	1199	Day Stroke Count	1205	
	Pump Off Setup	1188	Torque Setpoint	1194	Pct Drop Torque	1200	DI PumpOff Disbl	1206	
	Pump Off Action	1189	Pump Off Level	1195	Stroke Pos Count	1201	Pump OffSleepLvl	1207	
	Pump Off Control	1190	Pump Off Speed	1196	Stroke Per Min	1202	DI Pump Baseline	1208	
	Pump Off Status	1191	Pump Off Time	1197	Pump Off Count	1203			
	Pump Cycle Store	1192	Pct Cycle Torque	1198	PumpOff SleepCnt	1204			

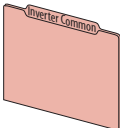


File	Group	Parameters		Parameters		Parameters			
<b>Applications</b> 	Profiling <sup>755</sup>	Profile Status	1210	DI Vel Override	1221	Step 1, 2, 3...16 Type	1230, 1240, 1250...1380		
		Units Traveled	1212	DI StrtStep Sel0	1222	Step 1, 2, 3...16 Velocity	1231, 1241, 1251...1381		
		Profile Command	1213	DI StrtStep Sel1	1223	Step 1, 2, 3...16 Accel	1232, 1242, 1252...1382		
		Counts Per Unit	1215	DI StrtStep Sel2	1224	Step 1, 2, 3...16 Decel	1233, 1243, 1253...1383		
		ProfVel Override	1216	DI StrtStep Sel3	1225	Step 1, 2, 3...16 Value	1234, 1244, 1254...1384		
		Prof DI Invert	1217	DI StrtStep Sel4	1226	Step 1, 2, 3...16 Dwell	1235, 1245, 1255...1385		
		DI Hold Step	1218			Step 1, 2, 3...16 Batch	1236, 1246, 1256...1386		
		DI Abort Step	1219			Step 1, 2, 3...16 Next	1237, 1247, 1257...1387		
		DI Abort Profile	1220			Step 1, 2, 3...16 Action	1238, 1248, 1258...1388		
						Step 1, 2, 3...16 Dig In	1239, 1249, 1259...1389		
	Camming <sup>755</sup>	PCAM Control	1390	PCAM Span X	1396	PCAM Main Pt X 0, 1, 2...15	1407, 1409, 1411...1437		
		PCAM Mode	1391	PCAM Scale X	1397	PCAM Main Pt Y 0, 1, 2...15	1408, 1410, 1412...1438		
		PCAM Psn Select	1392	PCAM Span Y	1398	PCAM Aux EndPnt	1439		
		PCAM Psn Stpt	1393	PCAM ScaleY Sel	1399	PCAM Aux Types	1440		
		PCAM Psn Ofst	1394	PCAM ScaleYSetPt	1400	PCAM Aux Pt X 1, 2, 3...15	1441, 1443, 1445...1469		
		PCAM PsnOfst Eps	1395	PCAM VelScaleSel	1401	PCAM Aux Pt Y 1, 2, 3...15	1442, 1444, 1446...1470		
				PCAM VelScaleSP	1402	PCAM Status	1471		
				PCAM Slope Begin	1403	PCAM Vel Out	1472		
				PCAM Slope End	1404	PCAM Psn Out	1473		
				PCAM Main EndPnt	1405	DI PCAM Start	1474		
			PCAM Main Types	1406					
	Roll Position <sup>755</sup>	Roll Psn Config	1500	Roll Psn Preset	1504	RP Rvls Output	1508	RP Unit Out	1512
		Roll Psn Status	1501	Roll Psn Offset	1505	RP Unwind	1509		
		RP Psn Fdbk Stpt	1502	RP EPR Input	1506	RP Unit Scale	1510		
		RP Psn Fdbk Sel	1503	RP Rvls Input	1507	RP Psn Output	1511		
	Torque Boost <sup>755</sup>	PsnTrqBst Ctrl	1515	PsnTrqBst UNWCnt	1519	PsnTrqBst Ps X4	1523	PsnTrqBst Trq Y4	1527
		PsnTrqBst Sths	1516	PsnTrqBst Ps X1	1520	PsnTrqBst Ps X5	1524	PsnTrqBst TrqOut	1528
		PsnTrqBst RefSel	1517	PsnTrqBst Ps X2	1521	PsnTrqBst Trq Y2	1525		
		PsnTrqBstPsnOfst	1518	PsnTrqBst Ps X3	1522	PsnTrqBst Trq Y3	1526		
	Variable Boost	VB Config	1535	VB Maximum	1540	VB Flux Thresh	1545	VB Cur Thresh	1550
		VB Status	1536	VB Accel Rate	1541	VB Flux Lag Freq	1546	VB Rate Lag Freq	1551
		VB Voltage	1537	VB Decel Rate	1542	VB Filt Flux Cur	1547		
		VB Time	1538	VB Frequency	1543	VB Current Rate	1548		
		VB Minimum	1539	VB Min Freq	1544	VB Current Hyst	1549		
	Spindle Orient <sup>755</sup>	SO Config	1580	SO EPR Input	1584	SO Unit Scale	1588	SO Decel Time	1592
		SO Status	1581	SO Rvls Input	1585	SO Position Out	1589	SO Fwd Vel Lmt	1593
		SO Setpoint	1582	SO Rvls Output	1586	SO Unit Out	1590	SO Rev Vel Lmt	1594
		SO Offset	1583	SO Cnts per Rvls	1587	SO Accel Time	1591		
	Id Compensation <sup>755</sup>	Id Comp Enbl	1600	Id Comp Mtrng 4	1607	Id Comp Regen 1	1613	Id Comp Regen 4	1619
		Id Comp Mtrng 1	1601	IdCompMtrng 4 lq	1608	IdCompRegen 1 lq	1614	IdCompRegen 4 lq	1620
		IdCompMtrng 1 lq	1602	Id Comp Mtrng 5	1609	Id Comp Regen 2	1615	Id Comp Regen 5	1621
		Id Comp Mtrng 2	1603	IdCompMtrng 5 lq	1610	IdCompRegen 2 lq	1616	IdCompRegen 5 lq	1622
		IdCompMtrng 2 lq	1604	Id Comp Mtrng 6	1611	Id Comp Regen 3	1617	Id Comp Regen 6	1623
		Id Comp Mtrng 3	1605	IdCompMtrng 6 lq	1612	IdCompRegen 3 lq	1618	IdCompRegen 6 lq	1624
		IdCompMtrng 3 lq	1606						

### Inverter Common (Port 10)

Inverter Common parameters are only used by PowerFlex 755 Frame 8 and larger drives.

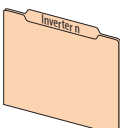
Parameter descriptions begin on [page 222](#).

File	Group	Parameters						
	System Ratings	Sys Rated Amps	1	I1 Rated Amps	3	I3 Rated Amps	5	
		Sys Rated Volts	2	I2 Rated Amps	4			
	Status	Online Status	10	Fault Status	12	Alarm Status	13	
	Metering	Ground Current	18	Recfg Acknowledg	20	Effctv I Rating	21	
	Testpoints	Testpoint Sel 1	30	Testpoint Val 1	31	Testpoint Sel 2	32	Testpoint Val 2

### Inverter n (Port 10)

Inverter n parameters are only used by PowerFlex 755 Frame 8 and larger drives.

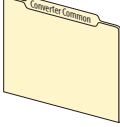
Parameter descriptions begin on [page 224](#).

File	Group	Parameters					
	Status	I1 Fault Status	105	I2 Fault Status	205	I3 Fault Status	305
		I1 Alarm Status	107	I2 Alarm Status	207	I3 Alarm Status	307
	Metering	I1 U Phase Curr	115	I2 U Phase Curr	215	I3 U Phase Curr	315
		I1 V Phase Curr	116	I2 V Phase Curr	216	I3 V Phase Curr	316
		I1 W Phase Curr	117	I2 W Phase Curr	217	I3 W Phase Curr	317
		I1 Gnd Current	118	I2 Gnd Current	218	I3 Gnd Current	318
		I1 DC Bus Volt	119	I2 DC Bus Volt	219	I3 DC Bus Volt	319
		I1 Heatsink Temp	120	I2 Heatsink Temp	220	I3 Heatsink Temp	320
		I1 IGBT Temp	121	I2 IGBT Temp	221	I3 IGBT Temp	321
		I1 HSFan Speed	124	I2 HSFan Speed	224	I3 HSFan Speed	324
		I1 InFan 1 Speed	125	I2 InFan 1 Speed	225	I3 InFan 1 Speed	325
		I1 InFan 2 Speed	126	I2 InFan 2 Speed	226	I3 InFan 2 Speed	326
	Predictive Main	I1 PredMainReset	127	I2 PredMainReset	227	I3 PredMainReset	327
		I1 HSFanElpsdLif	128	I2 HSFanElpsdLif	228	I3 HSFanElpsdLif	328
		I1 InFanElpsdLif	129	I2 InFanElpsdLif	229	I3 InFanElpsdLif	329
	Testpoints	I1 Testpt Sel 1	140	I2 Testpt Sel 1	240	I3 Testpt Sel 1	340
		I1 Testpt Val 1	141	I2 Testpt Val 1	241	I3 Testpt Val 1	341
		I1 Testpt Sel 2	142	I2 Testpt Sel 2	242	I3 Testpt Sel 2	342
		I1 Testpt Val 2	143	I2 Testpt Val 2	243	I3 Testpt Val 2	343

## Converter Common (Port 11)

Converter Common parameters are only used by AC input PowerFlex 755 Frame 8 and larger drives.

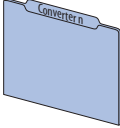
Parameter descriptions begin on [page 227](#).

File	Group	Parameters					
 <b>Converter Common</b>	System Ratings	Sys Rated Amps	1	C1 Rated Amps	3	C3 Rated Amps	5
		Sys Rated Volts	2	C2 Rated Amps	4		
	Status	Online Status	10	Fault Status	12	Alarm Status	13
	Configuration	Gnd Cur Flt Lvl	16	Converter Actn	17		
	Metering	L1 Phase Curr	20	L3 Phase Curr	22	SCR Temp	24
		L2 Phase Curr	21	Heatsink Temp	23	Gate Board Temp	25
Testpoints	Testpoint Sel 1	30	Testpoint Sel 2	32			
	Testpoint Val 1	31	Testpoint Val 2	33			

## Converter *n* (Port 11)

Converter *n* parameters are only used by AC input PowerFlex 755 Frame 8 and larger drives.

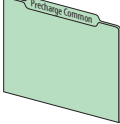
Parameter descriptions begin on [page 229](#).

File	Group	Parameters					
 <b>Converter n</b>	Status	C1 Fault Status1	105	C2 Fault Status1	205	C3 Fault Status1	305
		C1 Fault Status2	106	C2 Fault Status2	206	C3 Fault Status2	306
		C1 Alarm Status1	107	C2 Alarm Status1	207	C3 Alarm Status1	307
	Metering	C1 L1 Phase Curr	115	C2 L1 Phase Curr	215	C3 L1 Phase Curr	315
		C1 L2 Phase Curr	116	C2 L2 Phase Curr	216	C3 L2 Phase Curr	316
		C1 L3 Phase Curr	117	C2 L3 Phase Curr	217	C3 L3 Phase Curr	317
		C1 Gnd Current	118	C2 Gnd Current	218	C3 Gnd Current	318
		C1 DC Bus Volt	119	C2 DC Bus Volt	219	C3 DC Bus Volt	319
		C1 Heatsink Temp	120	C2 Heatsink Temp	220	C3 Heatsink Temp	320
		C1 SCR Temp	121	C2 SCR Temp	221	C3 SCR Temp	321
		C1 GateBoardTemp	122	C2 GateBoardTemp	222	C3 GateBoardTemp	322
		C1 AC Line Freq	123	C2 AC Line Freq	223	C3 AC Line Freq	323
		C1 L12 Line Volt	125	C2 L12 Line Volt	225	C3 L12 Line Volt	325
		C1 L23 Line Volt	126	C2 L23 Line Volt	226	C3 L23 Line Volt	326
	C1 L31 Line Volt	127	C2 L31 Line Volt	227	C3 L31 Line Volt	327	
	Predictive Main	C1 PredMainReset	137	C2 PredMainReset	237	C3 PredMainReset	337
		C1 CbFanElpsdLif	138	C2 CbFanElpsdLif	238	C3 CbFanElpsdLif	338
	Testpoints	C1 Testpt Sel 1	140	C2 Testpt Sel 1	240	C3 Testpt Sel 1	340
		C1 Testpt Val 1	141	C2 Testpt Val 1	241	C3 Testpt Val 1	341
		C1 Testpt Sel 2	142	C2 Testpt Sel 2	242	C3 Testpt Sel 2	342
		C1 Testpt Val 2	143	C2 Testpt Val 2	243	C3 Testpt Val 2	343

### Precharge Common (Port 11)

Precharge Common parameters are only used by DC input PowerFlex 755 Frame 8 and larger drives.

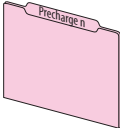
Parameter descriptions begin on [page 232](#).

File	Group	Parameters								
 <b>Precharge Common</b>	System Ratings	Sys Rated Amps	1	P1 Rated Amps	3	P3 Rated Amps	5			
		Sys Rated Volts	2	P2 Rated Amps	4					
	Status	Online Status	10	Fault Status	12	Alarm Status	13			
		Metering	Gate Board Temp	25	Main DC Bus Volt	18				
	Testpoints	Testpoint Sel 1	30	Testpoint Val 1	31	Testpoint Sel 2	32	Testpoint Val 2	33	

### Precharge n (Port 11)

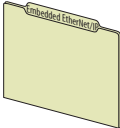
Precharge *n* parameters are only used by DC input PowerFlex 755 Frame 8 and larger drives.

Parameter descriptions begin on [page 234](#).

File	Group	Parameters							
 <b>Precharge n</b>	Status	P1 Board Status	104	P2 Board Status	204	P3 Board Status	304		
		P1 Fault Status1	105	P2 Fault Status1	205	P3 Fault Status1	305		
		P1 Fault Status2	106	P2 Fault Status2	206	P3 Fault Status2	306		
		P1 Alarm Status1	107	P2 Alarm Status1	207	P3 Alarm Status1	307		
		Metering	P1 DC Bus Volts	110	P2 DC Bus Volts	210	P3 DC Bus Volts	310	
		P1 Main DC Volts	111	P2 Main DC Volts	211	P3 Main DC Volts	311		
		P1 240VSplyVolts	112	P2 240VSplyVolts	212	P3 240VSplyVolts	312		
		P1 GateBoardTemp	122	P2 GateBoardTemp	222	P3 GateBoardTemp	322		
	Predictive Main	P1 PredMainReset	137	P2 PredMainReset	237	P3 PredMainReset	337		
		P1 CbFanElpsdLif	138	P2 CbFanElpsdLif	238	P3 CbFanElpsdLif	338		
	Testpoints	P1 Testpt Sel 1	140	P2 Testpt Sel 1	240	P3 Testpt Sel 1	340		
		P1 Testpt Val 1	141	P2 Testpt Val 1	241	P3 Testpt Val 1	341		
		P1 Testpt Sel 2	142	P2 Testpt Sel 2	242	P3 Testpt Sel 2	342		
		P1 Testpt Val 2	143	P2 Testpt Val 2	243	P3 Testpt Val 2	343		

## Embedded EtherNet/IP (Port 13)

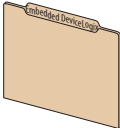
Parameter descriptions begin on [page 240](#).

File	Group	Parameters							
<b>Embedded EtherNet/IP Host Groups</b> 	N/A	DL From Net 01	1	Port Number	33	Flt Cfg DL 01	60	DLs Fr Peer Cfg	76
		DL From Net 02	2	DLs From Net Act	34	Flt Cfg DL 02	61	DLs Fr Peer Act	77
		DL From Net 03	3	DLs To Net Act	35	Flt Cfg DL 03	62	Logic Src Cfg	78
		DL From Net 04	4	BOOTP	36	Flt Cfg DL 04	63	Ref Src Cfg	79
		DL From Net 05	5	Net Addr Src	37	Flt Cfg DL 05	64	Fr Peer Timeout	80
		DL From Net 06	6	IP Addr Cfg 1	38	Flt Cfg DL 06	65	Fr Peer Addr 1	81
		DL From Net 07	7	IP Addr Cfg 2	39	Flt Cfg DL 07	66	Fr Peer Addr 2	82
		DL From Net 08	8	IP Addr Cfg 3	40	Flt Cfg DL 08	67	Fr Peer Addr 3	83
		DL From Net 09	9	IP Addr Cfg 4	41	Flt Cfg DL 09	68	Fr Peer Addr 4	84
		DL From Net 10	10	Subnet Cfg 1	42	Flt Cfg DL 10	69	Fr Peer Enable	85
		DL From Net 11	11	Subnet Cfg 2	43	Flt Cfg DL 11	70	Fr Peer Status	86
		DL From Net 12	12	Subnet Cfg 3	44	Flt Cfg DL 12	71	DLs To Peer Cfg	87
		DL From Net 13	13	Subnet Cfg 4	45	Flt Cfg DL 13	72	DLs To Peer Act	88
		DL From Net 14	14	Gateway Cfg 1	46	Flt Cfg DL 14	73	To Peer Period	89
		DL From Net 15	15	Gateway Cfg 2	47	Flt Cfg DL 15	74	To Peer Skip	90
		DL From Net 16	16	Gateway Cfg 3	48	Flt Cfg DL 16	75	To Peer Enable	91
		DL To Net 01	17	Gateway Cfg 4	49				
		DL To Net 02	18	Net Rate Cfg	50				
		DL To Net 03	19	Net Rate Act	51				
		DL To Net 04	20	Web Enable	52				
		DL To Net 05	21	Web Features	53				
		DL To Net 06	22	Comm Flt Action	54				
		DL To Net 07	23	Idle Flt Action	55				
		DL To Net 08	24	Peer Flt Action	56				
		DL To Net 09	25	Msg Flt Action	57				
		DL To Net 10	26	Flt Cfg Logic	58				
		DL To Net 11	27	Flt Cfg Ref	59				
		DL To Net 12	28						
		DL To Net 13	29						
		DL To Net 14	30						
		DL To Net 15	31						
		DL To Net 16	32						

## Embedded DeviceLogix (Port 14)

Embedded DeviceLogix parameters are only used by PowerFlex 755 drives.

Parameter descriptions begin on [page 249](#).

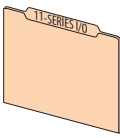
File	Group	Parameters							
<b>Embedded DeviceLogix Host Groups</b> 	Analog Outputs	DLX Out 01	1	DLX Out 05	5	DLX Out 09	9	DLX Out 13	13
		DLX Out 02	2	DLX Out 06	6	DLX Out 10	10	DLX Out 14	14
		DLX Out 03	3	DLX Out 07	7	DLX Out 11	11	DLX Out 15	15
		DLX Out 04	4	DLX Out 08	8	DLX Out 12	12	DLX Out 16	16
	Analog Inputs	DLX In 01	17	DLX In 05	21	DLX In 09	25	DLX In 13	29
		DLX In 02	18	DLX In 06	22	DLX In 10	26	DLX In 14	30
		DLX In 03	19	DLX In 07	23	DLX In 11	27	DLX In 15	31
		DLX In 04	20	DLX In 08	24	DLX In 12	28	DLX In 16	32
	Digital Inputs	DLX DIP 01	33	DLX DIP 05	37	DLX DIP 09	41	DLX DIP 13	45
		DLX DIP 02	34	DLX DIP 06	38	DLX DIP 10	42	DLX DIP 14	46
		DLX DIP 03	35	DLX DIP 07	39	DLX DIP 11	43	DLX DIP 15	47
		DLX DIP 04	36	DLX DIP 08	40	DLX DIP 12	44	DLX DIP 16	48
	Status & Cntl	DLX Digin Sts	49	DLX DigOut Sts	50	DLX Prog Cond	52	DLX Operation	53
				DLX DigOut Sts2	51				
	Internal Regs	DLX Real SP1	54	DLX DINT SP1	70	DLX Real InSP1	82	DLX DINT InSP1	98
			55	DLX DINT SP2	71	DLX Real InSP2	83	DLX DINT InSP2	99
56		DLX DINT SP3	72	DLX Real InSP3	84	DLX DINT InSP3	100		
57		DLX DINT SP4	73	DLX Real InSP4	85	DLX DINT InSP4	101		
58		DLX DINT SP5	74	DLX Real InSP5	86	DLX DINT OutSP1	102		
59		DLX DINT SP6	75	DLX Real InSP6	87	DLX DINT OutSP2	103		
60		DLX DINT SP7	76	DLX Real InSP7	88	DLX DINT OutSP3	104		
61		DLX DINT SP8	77	DLX Real InSP8	89	DLX DINT OutSP4	105		
62		DLX Bool SP1	78	DLX Real OutSP1	90				
63		DLX Bool SP2	79	DLX Real OutSP2	91				
64		DLX Bool SP3	80	DLX Real OutSP3	92				
65		DLX Bool SP4	81	DLX Real OutSP4	93				
66				DLX Real OutSP5	94				
67				DLX Real OutSP6	95				
68				DLX Real OutSP7	96				
69				DLX Real OutSP8	97				

## How Option Module Parameters are Organized

Option module parameters are only available when that option is installed in a host drive. To view and edit option module parameters, select the port number of the device you want to access from the Status Screen.


### 11-Series I/O Modules

Parameter descriptions begin on [page 252](#).

File	Group	Parameters	
<b>11-Series I/O Host Groups</b>	Digital Inputs	Dig In Sts	1 Dig In Filt Mask
	Digital Outputs	Dig Out Sts	5 R00 Sel
		Dig Out Invert	6 R00 Level Sel
		Dig Out Setpoint	7 R00 Level
			R00 Level CmpSts
			R00 On Time
			R00 Off Time
			R01 Level Sel
			T00 Sel
			R01 Level Sel
			T00 Level Sel
			R01 Level
			T00 Level
			R01 Level CmpSts
			T00 Level CmpSts
			R01 On Time
			T00 On Time
		R01 Off Time	
		T00 Off Time	
Motor PTC	ATEX Sts	41	
Analog Inputs	Anlg In Type	45	Anlg In0 Value
	Anlg In Sqrt	46	Anlg In0 Hi
	Anlg In Loss Sts	47	Anlg In0 Lo
			Anlg In0 LssActn
			Anlg In0 Raw Val
			Anlg In0 Filt Gn
			Anlg In0 Filt BW
Analog Outpts	Anlg Out Type	70	Anlg Out0 Sel
	Anlg Out Abs	71	Anlg Out0 Stpt
			Anlg Out0 Data
			Anlg Out0 DataHi
			Anlg Out0 DataLo
			Anlg Out0 Hi
			Anlg Out0 Lo
			Anlg Out0 Val
Predictive Main	PredMaint Sts	99	R00 Load Type
		100	R01 Load Type
		101	R01 Load Amps
		102	R01 TotalLife
		103	R01 ElapsedLife
		104	R01 RemainLife
		105	R01 LifeEvtLvl
		106	R01 LifeEvtActn

## 22-Series I/O Modules

Parameter descriptions begin on [page 252](#).

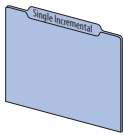
File	Group	Parameters								
<b>22-Series I/O Host Groups</b> 	Digital Inputs	Dig In Sts	1	Dig In Filt Mask	2	Dig In Filt	3			
	Digital Outputs	Dig Out Sts	5	R00 Sel	10	R01 Sel	20	T01 Sel	30	
		Dig Out Invert	6	R00 Level Sel	11	T00 Sel	20	T01 Level Sel	31	
		Dig Out Setpoint	7	R00 Level	12	R01 Level Sel	21	T01 Level	32	
				R00 Level CmpSts	13	T00 Level Sel	21	T01 Level CmpSts	33	
				R00 On Time	14	R01 Level	22	T01 On Time	34	
			R00 Off Time	15	T00 Level	22	T01 Off Time	35		
					R01 Level CmpSts	23				
					T00 Level CmpSts	23				
					R01 On Time	24				
					T00 On Time	24				
					R01 Off Time	25				
					T00 Off Time	25				
		Motor PTC	PTC Cfg	40	PTC Sts	41	PTC Raw Value	42		
		Analog Inputs	Anlg In Type	45	Anlg In0 Value	50	Anlg In1 Value	60		
			Anlg In Sqrt	46	Anlg In0 Hi	51	Anlg In1 Hi	61		
	Anlg In Loss Sts		47	Anlg In0 Lo	52	Anlg In1 Lo	62			
				Anlg In0 LssActn	53	Anlg In1 LssActn	63			
			Anlg In0 Raw Val	54	Anlg In1 Raw Val	64				
			Anlg In0 Filt Gn	55	Anlg In1 Filt Gn	65				
			Anlg In0 Filt BW	56	Anlg In1 Filt BW	66				
	Analog Outputs	Anlg Out Type	70	Anlg Out0 Sel	75	Anlg Out1 Sel	85			
		Anlg Out Abs	71	Anlg Out0 Stpt	76	Anlg Out1 Stpt	86			
				Anlg Out0 Data	77	Anlg Out1 Data	87			
				Anlg Out0 DataHi	78	Anlg Out1 DataHi	88			
				Anlg Out0 DataLo	79	Anlg Out1 DataLo	89			
				Anlg Out0 Hi	80	Anlg Out1 Hi	90			
				Anlg Out0 Lo	81	Anlg Out1 Lo	91			
				Anlg Out0 Val	82	Anlg Out1 Val	92			
	Predictive Main	PredMaint Sts	99	R00 Load Type	100	R01 Load Type	110			
				R00 Load Amps	101	R01 Load Amps	111			
				R00 TotalLife	102	R01 TotalLife	112			
				R00 ElapsedLife	103	R01 ElapsedLife	113			
				R00 RemainLife	104	R01 RemainLife	114			
				R00 LifeEvtLvl	105	R01 LifeEvtLvl	115			
	R00 LifeEvtActn	106	R01 LifeEvtActn	116						



## Single Incremental Encoder Module

Parameter descriptions begin on [page 273](#).

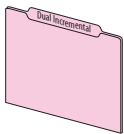
File	Group	Parameters							
<b>Single Incremental Encoder Host Groups</b>	N/A	Encoder Cfg	1	Fdbk Loss Cfg	3	Encoder Status	5	Phase Loss Count	7
		Encoder PPR	2	Encoder Feedback	4	Error Status	6	Quad Loss Count	8



## Dual Incremental Encoder Module


Parameter descriptions begin on [page 276](#).

File	Group	Parameters							
<b>Dual Incremental Encoder Host Groups</b>	Encoder 0	Enc 0 Cfg	1	Enc 0 FB Lss Cfg	3	Enc 0 Sts	5	Enc 0 PhsLssCnt	7
		Enc 0 PPR	2	Enc 0 FB	4	Enc 0 Error Sts	6	Enc 0 QuadLssCnt	8
	Encoder 1	Enc 1 Cfg	11	Enc 1 FB Lss Cfg	13	Enc 1 Sts	15	Enc 1 PhsLssCnt	17
		Enc 1 PPR	12	Enc 1 FB	14	Enc 1 Error Sts	16	Enc 1 QuadLssCnt	18
	Homing Cfg	Homing Cfg	20						
	Module Status	Module Sts	21						



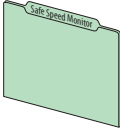
## Universal Feedback Module

Parameter descriptions begin on [page 281](#).

File	Group	Parameters							
<b>Universal Feedback Host Groups</b> 	Module	Module Sts	1						
		Module Err Reset	2						
	Feedback 0	FB0 Position	5	FB0 Cfg	8	FB0 Inc Cfg	16	FB0 SSI Turns	22
		FB0 Device Sel	6	FB0 Loss Cfg	9	FB0 Inc Sts	17	FB0 Lin CPR	25
		FB0 Identify	7	FB0 Sts	10	FB0 SSI Cfg	20	FB0 Lin Upd Rate	26
				FB0 IncAndSC PPR	15	FB0 SSI Resol	21	FB0 LinStahl Sts	27
	Feedback 1	FB1 Position	35	FB1 Cfg	38	FB1 Inc Cfg	46	FB1 SSI Turns	52
		FB1 Device Sel	36	FB1 Loss Cfg	39	FB1 Inc Sts	47	FB1 Lin CPR	55
		FB1 Identify	37	FB1 Sts	40	FB1 SSI Cfg	50	FB1 Lin Upd Rate	56
				FB1 IncAndSC PPR	45	FB1 SSI Resol	51	FB1 LinStahl Sts	57
	Encoder Out	Enc Out Sel	80	Enc Out FD PPR	82	Enc Out Z Offset	83		
		Enc Out Mode	81			Enc Out Z PPR	84		
	Registration	Rgsn Arm	90	Rgsn Latch1 Cfg	100	Rgsn Latch1 Psn	101	Rgsn Latch1 Time	102
		Rgsn In 0 Filter	91	Rgsn Latch2 Cfg	103	Rgsn Latch2 Psn	104	Rgsn Latch2 Time	105
		Rgsn In 1 Filter	92	Rgsn Latch3 Cfg	106	Rgsn Latch3 Psn	107	Rgsn Latch3 Time	108
		Rgsn HmIn Filter	93	Rgsn Latch4 Cfg	109	Rgsn Latch4 Psn	110	Rgsn Latch4 Time	111
		Rgsn Sts	94	Rgsn Latch5 Cfg	112	Rgsn Latch5 Psn	113	Rgsn Latch5 Time	114
				Rgsn Latch6 Cfg	115	Rgsn Latch6 Psn	116	Rgsn Latch6 Time	117
				Rgsn Latch7 Cfg	118	Rgsn Latch7 Psn	119	Rgsn Latch7 Time	120
				Rgsn Latch8 Cfg	121	Rgsn Latch8 Psn	122	Rgsn Latch8 Time	123
Rgsn Latch9 Cfg				124	Rgsn Latch9 Psn	125	Rgsn Latch9 Time	126	
Rgsn Latch10 Cfg				127	Rgsn Latch10 Psn	128	Rgsn Latch10 Time	129	

## Safe Speed Monitor Module

Parameter descriptions begin on [page 299](#).

File	Group	Parameters							
<b>Safe Speed Monitor Host Groups</b> 	Security	Password	1	Reset Defaults	7	Password Command	17	Config Flt Code	70
		Lock State	5	Signature ID	10	Security Code	18		
		Operating Mode	6	New Password	13	Vendor Password	19		
	General	Cascaded Config	20	Reset Type	22	SS Out Mode	72		
		Safety Mode	21	OverSpd Response	24	SLS Out Mode	73		
	Feedback	Fbk Mode	27	Fbk 1 Type	28	Fbk 2 Units	34	Fbk Speed Ratio	39
				Fbk 1 Units	29	Fbk 2 Polarity	35	Fbk Speed Tol	40
				Fbk 1 Polarity	30	Fbk 2 Resolution	36	Fbk Pos Tol	41
				Fbk 1 Resolution	31	Fbk 2 Volt Mon	37	Direction Mon	42
				Fbk 1 Volt Mon	32	Fbk 2 Speed	38	Direction Tol	43
				Fbk 1 Speed	33				
	Stop	Safe Stop Input	44	Stop Mon Delay	46	Standstill Speed	48	Decel Ref Speed	50
		Safe Stop Type	45	Max Stop Time	47	Standstill Pos	49	Stop Decel Tol	51
	Limited Speed	Lim Speed Input	52	Enable SW Input	54	Safe Speed Limit	55	Speed Hysteresis	56
		LimSpd Mon Delay	53						
	Door Control	Door Out Type	57	DM Input	58	Lock Mon Enable	59	Door Out Mode	74
						Lock Mon Input	60		
	Max Speed	Max Speed Enable	61	Max Spd Stop Typ	63	Safe Accel Limit	65		
		Safe Max Speed	62	Max Accel Enable	64	Max Acc Stop Typ	66		
	Faults	Fault Status	67	Config Flt Code	70	SS Out Mode	72		
Guard Status		68			SLS Out Mode	73			
IO Diag Status		69			Door Out Mode	74			

**Notes:**

## Drive Port 0 Parameters

This chapter lists and describes the PowerFlex 750-Series Port 0 drive parameters. The parameters can be programmed (viewed/edited) using a Human Interface Module (HIM). Refer to the PowerFlex 20-HIM-A6 and 20-HIM-C6S HIM (Human Interface Module) User Manual, publication [20HIM-UM001](#), for information on using the HIM to view and edit parameters. As an alternative, programming can also be performed using DriveTools™ software and a personal computer.

Parameter File	Page
Drive (Port 0) Monitor File	54
Drive (Port 0) Motor Control File	56
Drive (Port 0) Feedback & I/O File	70
Drive (Port 0) Cfg File	86
Drive (Port 0) Protection File	102
Drive (Port 0) Speed Control File	117
Drive (Port 0) Torque Control File	132
Drive (Port 0) Position Control File	139
Drive (Port 0) Communication File	154
Drive (Port 0) Diagnostics File	161
Drive (Port 0) Applications File	180

## Drive (Port 0) Monitor File

File	Group	No.	Display Name Full Name Description	Values		Read-Write	Data Type
				Units:	Default:		
MONITOR	Metering	1	<b>Output Frequency</b> Output Frequency Output frequency present at terminals T1, T2, and T3 (U, V & W)	Units: Hz Default: 0.00 Min/Max: -/+650.00		RO	Real
		2	<b>Commanded SpdRef</b> Commanded Speed Reference Value of the active Speed/Frequency Reference. Displayed in Hz or RPM, depending on the value of P300 [Speed Units].	Units: Hz RPM Default: 0.00 Min/Max: -/+P27 [Motor NP Hertz] x 8 -/+P28 [Motor NP RPM] x 8		RO	Real
		3	<b>Mtr Vel Fdbk</b> Motor Velocity Feedback Estimated or actual motor speed, with feedback. Displayed in Hz or RPM, depending on the value of P300 [Speed Units].	Units: Hz RPM Default: 0.00 Min/Max: -/+P27 [Motor NP Hertz] x 8 -/+P28 [Motor NP RPM] x 8		RO	Real
		4	<b>Commanded Trq</b> Commanded Torque External torque regulation reference. Summation of Torque A Select Reference and Torque B Select Reference. Percent of motor rated torque. See <a href="#">Figure 21</a> on page 393 or <a href="#">Figure 61</a> on page 436.	Units: % Default: 0.00 Min/Max: -/+800.00		RO	Real
		5	<b>Torque Cur Fdbk</b> Torque Current Feedback Based on the motor, the amount of current that is in phase with the fundamental voltage component.	Units: Amps Default: Based on Drive Rating Min/Max: -/+P21 [Rated Amps] x 2		RO	Real
		6	<b>Flux Cur Fdbk</b> Flux Current Feedback Amount of current that is out of phase with the fundamental voltage component.	Units: Amps Default: Based on Drive Rating Min/Max: -/+P21 [Rated Amps] x 2		RO	Real
		7	<b>Output Current</b> Output Current The total output current present at terminals T1, T2, and T3 (U, V & W).	Units: Amps Default: Based on Drive Rating Min/Max: 0.00 / P21 [Rated Amps] x 2		RO	Real
		8	<b>Output Voltage</b> Output Voltage Output voltage present at terminals T1, T2, and T3 (U, V & W).	Units: V AC Default: Based on Drive Rating Min/Max: 0.00 / P20 [Rated Volts] x 1.15		RO	Real
		9	<b>Output Power</b> Output Power Output power present at terminals T1, T2, and T3 (U, V & W).	Units: kW Default: 0.00 Min/Max: 0.00 / 3000.00		RO	Real
		10	<b>Output Powr Fctr</b> Output Power Factor Output power factor.	Default: 0.00 Min/Max: 0.00 / 1.00		RO	Real
		11	<b>DC Bus Volts</b> Direct Current Bus Volts DC bus voltage.	Units: V DC Default: Based on Drive Rating Min/Max: 0.00 / P20 [Rated Volts] x 2		RO	Real
		12	<b>DC Bus Memory</b> Direct Current Bus Memory A six-minute average of P11 [DC Bus Volts] used to estimate the DC equivalent of the input voltage. Automatically initialized upon power-up or precharge, continually updated during normal operation, and is used to trigger a power loss condition. Use P464 [DC Bus Mem Reset] to reset this parameter.	Units: V DC Default: Based on Drive Rating Min/Max: 0.00 / P20 [Rated Volts] x 2		RO	Real
		13	<b>Elapsed MWH</b> Elapsed Megawatt Hour Accumulated output energy of the drive. Use P336 [Reset Meters] to reset this parameter.	Units: MWh Default: 0.000 Min/Max: 0.000 / 4294967296.000		RO	Real

File	Group	No.	Display Name Full Name Description	Values		Read-Write	Data Type																																																															
MONITOR	Metering	14	<b>Elapsed kWh</b> Elapsed Kilowatt Hour Accumulated output energy of the drive. Use P336 [Reset Meters] to reset this parameter.	Units: kWh Default: 0.000 Min/Max: 0.000 / 4294967296.000		RO	Real																																																															
		15	<b>Elapsed Run Time</b> Elapsed Run Time Accumulated time drive is outputting power. Use P336 [Reset Meters] to reset this parameter.	Units: Hrs Default: 0.000 Min/Max: 0.000 / 220000000.000		RO	Real																																																															
		16	<b>Elpsd Mtr MWHrs</b> Elapsed Motor Megawatt Hours Accumulated output energy to the motor.	Units: MWh Default: 0.0 Min/Max: 0.0 / 220000000.0		RO	Real																																																															
		17	<b>Elpsd Rgn MWHrs</b> Elapsed Regenerated Motor Megawatt Hours Accumulated input energy from the motor.	Units: MWh Default: 0.0 Min/Max: 0.0 / 220000000.0		RO	Real																																																															
		18	<b>Elpsd Mtr kWhrs</b> Elapsed Motor Kilowatt Hours Accumulated output energy to the motor.	Units: kWh Default: 0.0000 Min/Max: 0.0000 / 220000000.0000		RO	Real																																																															
		19	<b>Elpsd Rgn kWhrs</b> Elapsed Regenerated Motor Kilowatt Hours Accumulated input energy from the motor.	Units: kWh Default: 0.0000 Min/Max: 0.0000 / 220000000.0000		RO	Real																																																															
	303	<b>Fdbk Filter Cfg</b> Feedback Filter Configuration  Configures the filtering on the following parameters. With the bit off the current filtering is used. With the bit on the unfiltered feedback will be used for the parameter.  Options <table border="1" style="font-size: small;"> <tr> <td></td> <td>Reserved</td><td>Reserved</td><td>Reserved</td><td>Reserved</td><td>Reserved</td><td>Reserved</td><td>Reserved</td><td>Reserved</td><td>Reserved</td><td>Reserved</td><td>Reserved</td><td>Reserved</td><td>Reserved</td><td>Reserved</td><td>Reserved</td><td>Reserved</td><td>UnFltFlxCurr</td><td>UnFltTrqCurr</td><td>UnFltOutCurr</td><td>UnFltDcBus V</td> </tr> <tr> <td>Default</td> <td>0</td><td>0</td><td>0</td><td>0</td><td>0</td><td>0</td><td>0</td><td>0</td><td>0</td><td>0</td><td>0</td><td>0</td><td>0</td><td>0</td><td>0</td><td>0</td><td>0</td><td>0</td><td>0</td><td>0</td><td>0</td> </tr> <tr> <td>Bit</td> <td>15</td><td>14</td><td>13</td><td>12</td><td>11</td><td>10</td><td>9</td><td>8</td><td>7</td><td>6</td><td>5</td><td>4</td><td>3</td><td>2</td><td>1</td><td>0</td><td></td><td></td><td></td><td></td><td></td> </tr> </table> 0 = Condition False 1 = Condition True		Reserved	Reserved	Reserved	Reserved	Reserved	Reserved	Reserved	Reserved	Reserved	Reserved	Reserved	Reserved	Reserved	Reserved	Reserved	Reserved	UnFltFlxCurr	UnFltTrqCurr	UnFltOutCurr	UnFltDcBus V	Default	0	0	0	0	0	0	0	0	0	0	0	0	0	0	0	0	0	0	0	0	0	Bit	15	14	13	12	11	10	9	8	7	6	5	4	3	2	1	0							RW	16-bit Integer
		Reserved	Reserved	Reserved	Reserved	Reserved	Reserved	Reserved	Reserved	Reserved	Reserved	Reserved	Reserved	Reserved	Reserved	Reserved	Reserved	UnFltFlxCurr	UnFltTrqCurr	UnFltOutCurr	UnFltDcBus V																																																	
	Default	0	0	0	0	0	0	0	0	0	0	0	0	0	0	0	0	0	0	0	0	0																																																
	Bit	15	14	13	12	11	10	9	8	7	6	5	4	3	2	1	0																																																					
Drive Data	20	<b>Rated Volts</b> Rated Voltage Input voltage class (208, 240, 400 etc.) of the drive. This value may change depending on the setting of parameters 305 [Voltage Class] or 306 [Duty Rating].	Units: V AC Default: Based on Drive Rating Min/Max: 0.00 / 690.00		RO	Real																																																																
	21	<b>Rated Amps</b> Rated Amperage Continuous current rating of drive. This value may change depending on the setting of parameters 305 [Voltage Class] or 306 [Duty Rating].	Units: Amps Default: Based on Drive Rating Min/Max: 0.00 / Dependent on Frame Rating		RO	Real																																																																
	22	<b>Rated kW</b> Rated Kilowatts Continuous power rating of drive.	Units: kW Default: Based on Drive Rating Min/Max: 0.00 / Dependent on Frame Rating		RO	Real																																																																

## Drive (Port 0) Motor Control File

File	Group	No.	Display Name Full Name Description	Values		Read-Write	Data Type
MOTOR CONTROL	Motor Data	25	<b>Motor NP Volts</b> Motor Nameplate Volts Rated volts shown on the motor nameplate.	Units: V AC Default: Based on Drive Rating and Voltage Class Min/Max: 0.10 x P25 [Motor NP Volts] / Based on Drive Rating and Voltage Class		RW	Real
		26	<b>Motor NP Amps</b> Motor Nameplate Amps Rated full load amps shown on the motor nameplate.	Units: Amps Default: Based on Drive Rating Min/Max: 0.01 x P21 [Rated Amps] / 14200.00		RW	Real
		27	<b>Motor NP Hertz</b> Motor Nameplate Hertz Rated frequency shown on the motor nameplate.	Units: Hz Default: Based on Drive Rating Min/Max: 2.00 / 650.00		RW	Real
		28	<b>Motor NP RPM</b> Motor Nameplate Revolutions Per Minute Rated RPM shown on the motor nameplate. Note: The value of this parameter must reflect the slip speed of the motor. For example, for a 60 Hz, 4 pole motor, a value of 1800 is synchronous speed, and 1750 is slip speed.	Units: RPM Default: Based on Drive Rating Min/Max: 1.0 / 40000.0		RW	Real
		29	<b>Mtr NP Pwr Units</b> Motor Nameplate Power Units Power units shown on the motor nameplate.	Default: Based on Drive Rating Options: 0 – HP 1 – kW		RW	32-bit Integer
		30	<b>Motor NP Power</b> Motor Nameplate Power Rated power shown on the motor nameplate.	Units: HP (P29 = 0) kW (P29 = 1) Default: Based on Drive Rating Min/Max: 0.01 / 2000.00		RW	Real
		31	<b>Motor Poles</b> Motor Poles Number of poles in the motor.  Poles = $\frac{120 \times [\text{Motor NP Hertz}]}{[\text{Motor NP RPM}]}$	Units: Pole Default: 4 Min/Max: 2 / 200		RW	32-bit Integer





File	Group	No.	Display Name Full Name Description	Values	Read-Write	Data Type
MOTOR CONTROL	Mtr Ctrl Options	35	<b>Motor Ctrl Mode</b> Motor Control Mode Motor type and motor control mode. InductionVHz (0) – Induction motor, volts per Hertz control mode. <b>Note:</b> When using the Induction VHz (0) motor control mode, see the diagram for voltage and frequency in the Volts per Hertz group on <a href="#">page 62</a> for additional detail on the drive programming. Induction SV (1) – Induction motor, sensorless vector control mode. Induct Econ (2) – Induction motor, economize control mode. Induction FV (3) – Induction motor, flux vector control mode. PM VHz (4) – Permanent magnet motor, volts per Hertz control mode. PM SV (5) – Permanent magnet motor, sensorless vector control mode. PM FV (6) – Permanent magnet motor, flux vector control mode. SyncRel VHz (7) – Synchronous Reluctance motor, volts per Hertz control mode. SyncRel SV (8) – Synchronous Reluctance motor, sensorless vector control mode. Adj VltgMode (9) – Adjustable voltage control mode. IPM FV (10) – Interior permanent magnet motor, flux vector control mode.	Default: 1 – Induction SV Options: 0 – InductionVHz 1 – Induction SV 2 – Induct Econ 3 – Induction FV 4 – PM VHz <b>755</b> <sup>(1)</sup> 5 – PM SV <b>755</b> <sup>(1)</sup> 6 – PM FV <b>755</b> <sup>(1)</sup> 7 – SyncRel VHz 8 – SyncRel SV 9 – Adj VltgMode <sup>(2)</sup> 10 – IPM FV  (1) See the table in P80 [PM Cfg] on <a href="#">page 64</a> . For permanent magnet motors see Motor Name Plate and Rating Specifications table in Appendix E for motor data. (2) In the Adjustable control voltage mode, verify that P40 [Mtr Option Cfg] Bit 15 = 0 and P36 [Maximum Voltage] and 37 [Maximum Freq] ≠ 0.	RW	32-bit Integer
		36	<b>Maximum Voltage</b> Maximum Voltage The highest voltage the drive will output.	Units: V AC Default: Based on Drive Rating and Voltage Class Min/Max: Based on Drive Rating and Voltage Class	RW	Real
		37	<b>Maximum Freq</b> Maximum Frequency Determines the frequency where voltage limiting begins. Voltage limiting is either the corresponding voltage from the curve or the value of parameter 36 [Maximum Voltage]. Only active when parameter 35 [Motor Ctrl Mode] is set to 0 "InductionVHz."	Units: Hz Default: Based on P27 [Motor NP Hertz] / P28 [Motor NP RPM] and Voltage Class Min/Max: $0.00016667 \times P27$ [Motor NP Hertz] / 650.00	RW	Real
		38	<b>PWM Frequency</b> Pulse Width Modulation Frequency Pulse Width Modulated frequency (power transistor switching frequency). Drive derating may occur with increased values. See the PowerFlex 750-Series AC Drive Technical Data, publication <a href="#">750-TD001</a> , for derating guidelines.	Units: kHz Default: Based on Drive Rating Min/Max: Based on Drive Rating	RW	Real


File	Group	No.	Display Name Full Name Description	Values	Read-Write	Data Type																																																																																																			
MOTOR CONTROL	Mtr Ctrl Options	40	<p><b>Mtr Options Cfg</b> Motor Options Configuration</p> <p>Configuration of motor control-related functions. For motors above 200 Hz, a carrier frequency of 8 kHz or higher is recommended. Consider drive derate and motor lead distance restrictions.</p> <p>Options</p> <table border="1"> <thead> <tr> <th></th> <th>Reserved</th> <th>Reserved</th> <th>Reserved</th> <th>Reserved</th> <th>Reserved</th> <th>Reserved</th> <th>Reserved</th> <th>Reserved</th> <th>Reserved</th> <th>Reserved</th> <th>Reserved</th> <th>Reserved</th> <th>Reserved</th> <th>Reserved</th> <th>Reserved</th> <th>Reserved</th> <th>Jerk Select</th> <th>Not Used</th> <th>Common Mode</th> <th>Xsistor Diag<sup>(1)</sup></th> <th>Elect Stab</th> <th>DB WhileStop</th> <th>PWM FreqLock</th> <th>AsyncPWMLock</th> <th>PWM Type Sel</th> <th>RS Adaption</th> <th>Reflect Wave</th> <th>Mtr Lead Rev</th> <th>EnclsTrqProv<sup>(2)</sup></th> <th>Trq ModeLog</th> <th>Trq ModeStop</th> <th>Zero TrqStop</th> </tr> </thead> <tbody> <tr> <td>Default</td> <td>0</td> <td>0</td> <td>0</td> <td>0</td> <td>0</td> <td>0</td> <td>0</td> <td>0</td> <td>0</td> <td>0</td> <td>0</td> <td>0</td> <td>0</td> <td>0</td> <td>0</td> <td>0</td> <td>1</td> <td>0</td> <td>0</td> <td>1</td> <td>1</td> <td>0</td> <td>0</td> <td>0</td> <td>1</td> <td>1</td> <td>1</td> <td>0</td> <td>0</td> <td>1</td> <td>1</td> <td>1</td> </tr> <tr> <td>Bit</td> <td>32</td> <td>30</td> <td>29</td> <td>28</td> <td>27</td> <td>26</td> <td>25</td> <td>24</td> <td>23</td> <td>22</td> <td>21</td> <td>20</td> <td>19</td> <td>18</td> <td>17</td> <td>16</td> <td>15</td> <td>14</td> <td>13</td> <td>12</td> <td>11</td> <td>10</td> <td>9</td> <td>8</td> <td>7</td> <td>6</td> <td>5</td> <td>4</td> <td>3</td> <td>2</td> <td>1</td> <td>0</td> </tr> </tbody> </table> <p>(1) 753 drive default is 1 = Enabled. 755 drive default is 0 = Disabled.</p> <p>(2) 755 drives only.</p> <p>Bit 0 "Zero TrqStop" – Configures stopped condition when in torque mode. 0 = wait for zero speed before shutting off drive output, 1 = wait for zero torque before shutting off drive output.</p> <p>Bit 1 "Trq ModeStop" – Configures stopping behavior when in torque mode. 0 = remain in torque mode, 1 = switch to speed mode</p> <p>Bit 2 "Trq ModeLog" – Configures jogging behavior when in torque mode. 0 = remain in torque mode, 1 = switch to speed mode</p> <p>Bit 3 "EnclsTrqProv" – Enables encoderless mode when using the torque prove function. 0 = Disabled, 1 = Enabled. Bits 0 and 1 of P1100 [Trq Prove Cfg] must also be set to use this mode.</p> <p>Bit 4 "Mtr Lead Rev" – Reverses the phase rotation of the applied voltage, effectively reversing the motor leads. 0 = Not Reversed, 1 = Reversed</p> <p>Bit 5 "Reflect Wave" – Enables reflected wave voltage protection for long motor cables. 0 = Disabled, 1 = Enabled</p> <p>Bit 6 "RS Adaption" – Adapts for changes in motor stator resistance due to motor temperature. Active only in FV motor control mode with feedback. 0 = Disabled, 1 = Enabled</p> <p>Bit 7 "PWM Type Sel" – Configures 3 Phase / 2 Phase switching of the power devices. 0 = 3 Phase modulation with auto switchover to 2 phase modulation. 1 = Full time 3 phase modulation (no switchover)</p> <p>Bit 8 "AsyncPWMLock" – Configures Synchronous / Asynchronous switching of the power devices. 0 = Automatically changes between synchronous and asynchronous. 1 = Asynchronous switching only.</p> <p>Bit 9 "PWM FreqLock" – Configures switching frequency of the power devices while in FV motor control mode without feedback. 0 = switching frequency automatically reduces to 2 kHz at low speeds (best performance), 1 = switching frequency does not reduce (setting used when switching frequency reduction is undesirable)</p> <p>Bit 10 "DB WhileStop" – Enables operation of the dynamic brake transistor while the drive is stopped. 0 = Disabled, 1 = Enabled</p> <p>Bit 11 "Elect Stab" – Enables stability control for Sensorless Vector and V/Hz motor control modes. 0 = Disabled, 1 = Enabled</p> <p>Bit 12 "Xsistor Diag" – Enables power transistor diagnostic test at each start command. Recommended to set to Disabled if an output filter is installed with the drive. Refer to <a href="#">publication PFLEX-AT002</a> for additional information. 0 = Disabled, 1 = Enabled</p> <p>Bit 13 "Common Mode" – Enables the common mode reduction feature. See Parameter 41, Common Mode Type, for common mode type selection.</p> <p>Bit 15 "Jerk Select" – Limits the rate of change to the velocity reference for improved current limiting. This setting applies only to Sensorless Vector and V/Hz motor control modes. 0 = Disabled (0.0 second ramp time achievable), 1 = Enabled (0.0 second ramp time prevented)</p>		Reserved	Reserved	Reserved	Reserved	Reserved	Reserved	Reserved	Reserved	Reserved	Reserved	Reserved	Reserved	Reserved	Reserved	Reserved	Reserved	Jerk Select	Not Used	Common Mode	Xsistor Diag <sup>(1)</sup>	Elect Stab	DB WhileStop	PWM FreqLock	AsyncPWMLock	PWM Type Sel	RS Adaption	Reflect Wave	Mtr Lead Rev	EnclsTrqProv <sup>(2)</sup>	Trq ModeLog	Trq ModeStop	Zero TrqStop	Default	0	0	0	0	0	0	0	0	0	0	0	0	0	0	0	0	1	0	0	1	1	0	0	0	1	1	1	0	0	1	1	1	Bit	32	30	29	28	27	26	25	24	23	22	21	20	19	18	17	16	15	14	13	12	11	10	9	8	7	6	5	4	3	2	1	0		RW	32-bit Integer
			Reserved	Reserved	Reserved	Reserved	Reserved	Reserved	Reserved	Reserved	Reserved	Reserved	Reserved	Reserved	Reserved	Reserved	Reserved	Reserved	Jerk Select	Not Used	Common Mode	Xsistor Diag <sup>(1)</sup>	Elect Stab	DB WhileStop	PWM FreqLock	AsyncPWMLock	PWM Type Sel	RS Adaption	Reflect Wave	Mtr Lead Rev	EnclsTrqProv <sup>(2)</sup>	Trq ModeLog	Trq ModeStop	Zero TrqStop																																																																							
Default	0	0	0	0	0	0	0	0	0	0	0	0	0	0	0	0	1	0	0	1	1	0	0	0	1	1	1	0	0	1	1	1																																																																									
Bit	32	30	29	28	27	26	25	24	23	22	21	20	19	18	17	16	15	14	13	12	11	10	9	8	7	6	5	4	3	2	1	0																																																																									
		41	<p><b>Common Mode Type</b></p> <p>Common Mode Type</p> <p>CMV (0) – Reduces common mode voltage that degrades motor bearings and corrupts signals in control systems. It produces high DC bus ripple and reduces DC bus capacitor life.</p> <p>CMI (1) – Reduces common mode current within the drive that helps reduce the stress on the power components when the jumpers are disconnected on a solidly grounded network.</p>	<p>Default: 0 – CMV</p> <p>Options: 0 – CMV 1 – CMI</p>	RW	32-bit Integer																																																																																																			

File	Group	No.	Display Name Full Name Description	Values		Read-Write	Data Type
MOTOR CONTROL	Mtr Ctrl Options	42	<b>Bus Utilization</b> Bus Utilization The maximum allowed bus voltage utilization for the Motor Control. Do not change this value without consulting Technical Support. Higher values may result in control instability or over-current faults.	Units: Default: Min/Max:	% 95.00 85.00 / 100.00	RW	Real
		43	<b>Flux Up Enable</b> Flux Up Enable Manual (0) – Flux is established for P44 [Flux Up Time] before initial acceleration. Automatic (1) – Flux is established for a calculated time period based on motor nameplate data before acceleration. P44 [Flux Up Time] is not used.	Default: Options:	1 – Automatic 0 – Manual 1 – Automatic	RW	32-bit Integer
		44	<b>Flux Up Time</b> Flux Up Time The amount of time the drive will use to try to achieve full motor stator flux. When a Start command is issued, DC current at P26 [Motor NP Amps] level is used to build stator flux before accelerating. This parameter cannot be changed unless P43 [Flux Up Enable] is set to 0 "Manual."	Units: Default: Min/Max:	Secs 0.0000 0.0000 / 5.0000	RW	Real
		45	<b>Flux Down Ki</b> Flux Down Ki The integral term used in the voltage regulator which controls the removal of flux in the motor. Refer to the PowerFlex 750-Series AC Drives Installation Instructions, publication <a href="#">750-IN001</a> , for jumper locations and positions.	Default: Min/Max:	0.20 0.00 / 100.00	RW	Real
		46	<b>Flux Down Kp</b> Flux Down Kp The proportional term used in the voltage regulator which controls the removal of flux in the motor.	Default: Min/Max:	150.0 0.0 / 10000.0	RW	Real
		47	<b>Econ At Ref Ki</b> Economize At Reference Ki Integral gain that determines the response of the output voltage when P35 [Motor Ctrl Mode] option 2 "Induct Econ" is selected and the output frequency is at its reference.	Default: Min/Max:	305.0 0.0 / 100000.0	RW	Real
		48	<b>Econ AccDec Ki</b> Economize Acceleration/Deceleration Ki Integral gain that determines the response of the output voltage when P35 [Motor Ctrl Mode] option 2 "Induct Econ" is selected and the output frequency is either accelerating or decelerating to a reference.	Default: Min/Max:	200.0 0.0 / 100000.0	RW	Real
		49	<b>Econ AccDec Kp</b> Economize Acceleration/Deceleration Kp Proportional gain that determines the response of the output voltage when P35 [Motor Ctrl Mode] option 2 "Induct Econ" is selected and the output frequency is either accelerating or decelerating to a reference.	Units: Default: Min/Max:	V/A 100.0 0.0 / 1000000.0	RW	Real
		50	<b>Stability Filter</b> Stability Filter The filter time constant for the angle and voltage stability control.	Units: Default: Min/Max:	Secs 5162.22 0.00 / 1000000.00	RW	Real
		51	<b>Stab Volt Gain</b> Stability Voltage Gain The gain of the voltage stability control function. Active in all modes <b>except</b> when any FV motor control mode is selected in P35 [Motor Ctrl Mode] with speed feedback.	Default: Min/Max:	5322.22 0.00 / 10000000.00	RW	Real
		52	<b>Stab Angle Gain</b> Stability Angle Gain The gain of the electrical angle stability control function. Active in all modes <b>except</b> when any FV motor control mode is selected in P35 [Motor Ctrl Mode] with speed feedback.	Default: Min/Max:	790.43 0.00 / 10000000.00	RW	Real

File	Group	No.	Display Name Full Name Description	Values		Read-Write	Data Type
MOTOR CONTROL	Mtr Ctrl Options	1648	<b>IPM V FB HP Filt</b> IPM Voltage Feedback High Pass Filter High Pass Filter setting for the High Speed angle control. <b>Note:</b> This parameter is not used by Frame 8 drives and larger.	Default: Min/Max:	15.0 1.0 / 50.0	RW	Real
		1649	<b>IPM SpdEst Filt</b> IPM Speed Estimator Filter Bandwidth (BW) setting for the Speed Estimator filter. <b>Note:</b> This parameter is not used by Frame 8 drives and larger.	Units: Default: Min/Max:	R/S 1000.0 1.0 / 9999.9	RW	Real
		1650	<b>IPM SpdEst Kp</b> IPM Speed Estimator Kp Kp tuning value for the Speed Estimator. <b>Note:</b> This parameter is not used by Frame 8 drives and larger.	Default: Min/Max:	30.0 0.0 / 1000.0	RW	Real
		1651	<b>IPM SpdEst Ki</b> IPM Speed Estimator Ki Ki tuning value for the Speed Estimator. <b>Note:</b> This parameter is not used by Frame 8 drives and larger.	Default: Min/Max:	2500.0 0.0 / 25000.0	RW	Real
		1652	<b>IPM SpdEst KiAdj</b> IPM Speed Estimator Ki Adjust Step size used to adjust the Ki value of the Speed Estimator during no load conditions. <b>Note:</b> This parameter is not used by Frame 8 drives and larger.	Default: Min/Max:	75.0 0.0 / 500.0	RW	Real
		1653	<b>IPM Tran PWM</b> IPM Transition PWM Transition frequency where the PWM type is changed during deceleration. <b>Note:</b> This parameter is not used by Frame 8 drives and larger.	Units: Default: Min/Max:	Hz 8.0 3.0 / 200.0	RW	Real
		1654	<b>IPMTran PWM Hyst</b> IPM Transition PWM Hysteresis Hysteresis frequency used with P1653 [IPM Tran PWM] during acceleration. <b>Note:</b> This parameter is not used by Frame 8 drives and larger.	Units: Default: Min/Max:	Hz 2.0 0.0 / 50.0	RW	Real
		1655	<b>IPM Tran Mode</b> IPM Transition Mode Transition frequency where the control angle is changed during deceleration. <b>Note:</b> This parameter is not used by Frame 8 drives and larger.	Units: Default: Min/Max:	Hz 4.0 0.5 / 200.0	RW	Real
		1656	<b>IPM TranMod Hyst</b> IPM Transition Mode Hysteresis Hysteresis frequency used with P1655 [IPM Tran Mode] during acceleration. <b>Note:</b> This parameter is not used by Frame 8 drives and larger.	Units: Default: Min/Max:	Hz 3.0 0.0 / 50.0	RW	Real
		1657	<b>IPM Tran Filt Lo</b> IPM Transition Filter Low Bandwidth (BW) setting for the frequency used for Transition of angle and PWM during acceleration. <b>Note:</b> This parameter is not used by Frame 8 drives and larger.	Units: Default: Min/Max:	R/S 35.0 1.0 / 9999.0	RW	Real
		1658	<b>IPM Tran Filt Hi</b> IPM Transition Filter High Bandwidth (BW) setting for the frequency used for Transition of angle and PWM during deceleration. <b>Note:</b> This parameter is not used by Frame 8 drives and larger.	Units: Default: Min/Max:	R/S 1000.0 1.0 / 9999.0	RW	Real

File	Group	No.	Display Name Full Name Description	Values	Read-Write	Data Type
MOTOR CONTROL	Mtr Ctrl Options	1659	<b>IPM Tran Angle</b> IPM Transition Angle Difference Threshold between High and Low angle control to allow transition. <b>Note:</b> This parameter is not used by Frame 8 drives and larger.	Units: Cnts Default: 100.0 Min/Max: 5.0 / 500.0	RW	Real
		1660	 <b>IPM Stc Ofstst K</b> IPM Static Offset Test Constant Reduction factor for Static Offset test pulses. <b>Note:</b> This parameter is not used by Frame 8 drives and larger.	Default: 1.00 Min/Max: 0.10 / 9.00	RW	Real
		1661	 <b>IPM Lq Cmd BW</b> IPM Lq Command Bandwidth IqFddk Filter Bandwidth (BW) used to select the Active Lq for the IPM control. <b>Note:</b> This parameter is not used by Frame 8 drives and larger.	Units: R/S Default: 10.0 Min/Max: 1.0 / 999.9	RW	Real
		1662	<b>IPM SpdEst Kp Hi</b> IPM Speed Estimator Kp High Kp High tuning value for the Speed Estimator at high speed. <b>Note:</b> This parameter is not used by Frame 8 drives and larger.	Default: 30.0 Min/Max: 0.00 / 5000.0	RW	Real








File	Group	No.	Display Name Full Name Description	Values	Read-Write	Data Type		
MOTOR CONTROL	Volts per Hertz	60	<b>Start Acc Boost</b> Start/Acceleration Boost The voltage boost level for starting and acceleration when a “VHz” mode is selected, according to P35 [Motor Ctrl Mode]. Refer to diagram for P524 [Overspeed Limit].	Units: V AC Default: Based on Drive Rating Min/Max: 0.00 / Based on Drive Rating and Voltage Class	RW	Real		
		61	<b>Run Boost</b> Run Boost The boost level for steady state and deceleration when a “VHz” mode is selected, according to P35 [Motor Ctrl Mode]. Refer to diagram for P524 [Overspeed Limit].	Units: V AC Default: Based on Drive Rating Min/Max: 0.00 / Based on Drive Rating and Voltage Class	RW	Real		
		62	<b>Break Voltage</b> Break Voltage The voltage the drive will output at P63 [Break Frequency] when a “VHz” mode is selected, according to P35 [Motor Ctrl Mode]. Refer to diagram for P524 [Overspeed Limit].	Units: V AC Default: Based on Drive Rating and Voltage Class Min/Max: 0.00 / P25 [Motor NP Volts] x 1.5	RW	Real		
		63	<b>Break Frequency</b> Break Frequency The frequency the drive will output at P62 [Break Voltage] when a “VHz” mode is selected, according to P35 [Motor Ctrl Mode]. Refer to diagram for P524 [Overspeed Limit].	Units: Hz Default: P27 [Motor NP Hertz] x 0.25 Min/Max: 0.00 / P27 [Motor NP Hertz]	RW	Real		
		<p>This diagram (with P65 set to Custom V/Hz) depicts the Voltage to Frequency ratio when using the Induction VHz (0) motor control mode.</p>						
		64	<b>SVC Boost Filter</b> SVC Boost Filter The voltage boost filter time constant when a “SVC” mode is selected, according to P35 [Motor Ctrl Mode].	Units: Secs Default: 0.1000 Min/Max: 0.0001 / 1000.0000	RW	Real		
		65	<b>VHz Curve</b> VHz Curve Selects either a predefined curve (for example Fan/Pump), or a custom curve when a “VHz” mode is selected, according to P35 [Motor Ctrl Mode]. Refer to diagram for P524 [Overspeed Limit]. See Motor Control Modes in the PowerFlex 750-Series AC Drives Reference Manual, publication <a href="#">750-RM002</a> , for more information on the Fan/Pump option.	Default: 0 – Custom V/Hz Options: 0 – Custom V/Hz 1 – Fan/Pump	RW	32-bit Integer		

File	Group	No.	Display Name Full Name Description	Values	Read-Write	Data Type
MOTOR CONTROL	Autotune	70	<p><b>Autotune</b> Autotune</p> <p>Provides a manual or automatic method for setting P73 [IR Voltage Drop], P74 [Ixo Voltage Drop] and P75 [Flux Current Ref]. Valid only when parameter P35 [Motor Ctrl Mode] is set to 1 "Induction SV", 2 "Induct Econ", or 3 "Induction FV."</p> <p>Ready (0) – Parameter returns to this setting following a "Static Tune" or "Rotate Tune", at which time another start transition is required to operate the drive in normal mode. It also permits manually setting P73 [IR Voltage Drop], P74 [Ixo Voltage Drop] and P75 [Flux Current Ref].</p> <p>Calculate (1) – Uses motor nameplate data to automatically set P73 [IR Voltage Drop], P74 [Ixo Voltage Drop], P75 [Flux Current Ref] and P621 [Slip RPM at FLA].</p> <p>Static Tune (2) – A temporary command that initiates a non-rotational motor stator resistance test for the best possible automatic setting of P73 [IR Voltage Drop] in all valid modes and a non-rotational motor leakage inductance test for the best possible automatic setting of P74 [Ixo Voltage Drop] in a Flux Vector (FV) mode. A start command is required following initiation of this setting. Used when motor cannot be rotated.</p> <p>Rotate Tune (3) – A temporary command that initiates a "Static Tune" followed by a rotational test for the best possible automatic setting of P75 [Flux Current Ref]. In Flux Vector (FV) mode, with encoder feedback, a test for the best possible automatic setting of P621 [Slip RPM at FLA] is also run. A start command is required following initiation of this setting. <b>Important:</b> If using rotate tune for a Sensorless Vector (SV) mode, the motor should be uncoupled from the load or results may not be valid. With a Flux Vector (FV) mode, either a coupled or uncoupled load will produce valid results.</p> <hr/> <p> <b>ATTENTION:</b> Rotation of the motor in an undesired direction can occur during this procedure. To guard against possible injury and/or equipment damage, it is recommended that the motor be disconnected from the load before proceeding.</p> <hr/> <p>Inertia Tune (4) – A temporary command that initiates an inertia test of the motor/load combination. The motor will ramp up and down while the drive measures the amount of inertia. This option only applies to FV modes selected in P35 [Motor Ctrl Mode]. Final test results should be obtained with load coupled to the motor.</p>	Default: 1 – Calculate Options: 0 – Ready 1 – Calculate 2 – Static Tune 3 – Rotate Tune 4 – Inertia Tune	RW	32-bit Integer
		71	<p><b>Autotune Torque</b> Autotune Torque</p> <p>The motor torque applied to the motor during the flux current and inertia tests.</p>	Units: % Default: 50.00 Min/Max: 0.00 / 200.00	RW	Real
		73	<p><b>IR Voltage Drop</b> IR Voltage Drop</p> <p>Value of voltage drop across the resistance of the motor stator at rated motor current. Used only when P35 [Motor Ctrl Mode] is set to 1 "Induction SV", 2 "Induct Econ", or 3 "Induction FV." This parameter cannot be changed unless P70 [Autotune] is set to 0 "Ready."</p>	Units: Volt Default: Based on Drive Rating Min/Max: 0.00 / Based on Drive Rating and Voltage Class	RW	Real
		74	<p><b>Ixo Voltage Drop</b> Ixo Voltage Drop</p> <p>Value of voltage drop across the leakage inductance of the motor at rated motor current. Used only when P35 [Motor Ctrl Mode] is set to 3 "Induction FV." This parameter cannot be changed unless P70 [Autotune] is set to 0 "Ready."</p>	Units: V AC Default: Based on Drive Rating and Voltage Class Min/Max: 0.00 / P25 [Motor NP Volts]	RW	Real
		75	<p><b>Flux Current Ref</b> Flux Current Reference</p> <p>Value of amps for full motor flux. This parameter cannot be changed unless P70 [Autotune] is set to 0 "Ready."</p>	Units: Amps Default: P21 [Rated Amps] x 0.35 Min/Max: 0.00 / P21 [Rated Amps] x 0.995	RW	Real
		76	<p><b>Total Inertia</b> Total Inertia</p> <p>Time in seconds for a motor coupled to a load to accelerate from zero to base speed at rated motor torque. Calculated during auto-tune. Only use this parameter when P35 [Motor Ctrl Mode] is set to 3 "Induction FV."</p>	Units: Secs Default: 2.00 Min/Max: 0.01 / 600.00	RW	Real

File	Group	No.	Display Name Full Name Description	Values	Read-Write	Data Type																																																												
MOTOR CONTROL	Autotune	77	<b>Inertia Test Lmt</b> Inertia Test Limit Maximum number of revolutions the motor rotates during the Inertia AutoTune test. When the value is zero, the limit is not active.	Units: Revs Default: 0.0 Min/Max: 0.0 / 65535.0	RW	Real																																																												
		78	<b>EncdrLss AngComp</b> Encoderless Angle Compensation Represents electrical angle compensation dependent on motor cable and PWM Frequency. Determined during autotuning when P35 [Motor Ctrl Mode] is set to one of the FV modes without speed feedback.	Units: Rad Default: 0.0000 Min/Max: -/+6.2831	RW	Real																																																												
		79	<b>EncdrLss VltComp</b> Encoderless Voltage Compensation Represents voltage compensation dependent on motor cable and PWM Frequency. Determined during autotuning when P35 [Motor Ctrl Mode] is set to one of the FV modes without speed feedback.	Units: V AC Default: Based on Drive Rating Min/Max: 0.00 / Based on Drive Rating and Voltage Class	RW	Real																																																												
		80	<b>PM Cfg</b> Permanent Magnet Motor Configuration		RW	16-bit Integer																																																												
		<table border="1"> <thead> <tr> <th>Mode</th> <th>Bit 0</th> <th>Bit 1</th> <th>Bit 2</th> <th>Bit 3</th> <th>Bit 4</th> <th>Bit 5</th> <th>Bit 6</th> <th>Bit 7</th> </tr> </thead> <tbody> <tr> <td>PM with Absolute Feedback (Stegmann, SSI, Heidenhaim)</td> <td></td> <td>X</td> <td></td> <td></td> <td></td> <td></td> <td></td> <td></td> </tr> <tr> <td>PM with Incremental Encoder (Pulse, SIN/COS)</td> <td>X</td> <td>X</td> <td></td> <td></td> <td></td> <td></td> <td></td> <td></td> </tr> <tr> <td>PM without Feedback</td> <td></td> <td>X</td> <td>X</td> <td>X</td> <td></td> <td></td> <td></td> <td></td> </tr> <tr> <td>IPM with Absolute Feedback (Stegmann, SSI, Heidenhaim)</td> <td></td> <td></td> <td></td> <td></td> <td></td> <td>X</td> <td></td> <td></td> </tr> <tr> <td>IPM with Incremental Encoder (Pulse, SIN/COS)</td> <td>X</td> <td></td> <td></td> <td></td> <td></td> <td>X</td> <td></td> <td></td> </tr> <tr> <td>IPM without Feedback</td> <td></td> <td></td> <td>X</td> <td></td> <td></td> <td>X</td> <td></td> <td></td> </tr> </tbody> </table> <p style="text-align: right;">X = 1</p>		Mode	Bit 0	Bit 1	Bit 2	Bit 3	Bit 4	Bit 5	Bit 6	Bit 7	PM with Absolute Feedback (Stegmann, SSI, Heidenhaim)		X							PM with Incremental Encoder (Pulse, SIN/COS)	X	X							PM without Feedback		X	X	X					IPM with Absolute Feedback (Stegmann, SSI, Heidenhaim)						X			IPM with Incremental Encoder (Pulse, SIN/COS)	X					X			IPM without Feedback			X			X		
Mode	Bit 0	Bit 1	Bit 2	Bit 3	Bit 4	Bit 5	Bit 6	Bit 7																																																										
PM with Absolute Feedback (Stegmann, SSI, Heidenhaim)		X																																																																
PM with Incremental Encoder (Pulse, SIN/COS)	X	X																																																																
PM without Feedback		X	X	X																																																														
IPM with Absolute Feedback (Stegmann, SSI, Heidenhaim)						X																																																												
IPM with Incremental Encoder (Pulse, SIN/COS)	X					X																																																												
IPM without Feedback			X			X																																																												
<p>This parameter also includes two options for PM FV mode selected by P35 [Motor Ctrl Mode].</p> <table border="1"> <thead> <tr> <th>Options</th> <th>Reserved</th> <th>Reserved</th> <th>Reserved</th> <th>Reserved</th> <th>Reserved</th> <th>Reserved</th> <th>NoMilimit</th> <th>NoIntgHld</th> <th>IdsCmdFFwdEn<sup>(1)</sup></th> <th>VCmdPhShftEn</th> <th>IPMTqTrmEn</th> <th>IPM Vqs Disa</th> <th>PMStabAnglEn</th> <th>StaticTestEn</th> <th>Vqs Reg En</th> <th>AutoOfstTest</th> </tr> </thead> <tbody> <tr> <td>Default</td> <td>0</td> <td>0</td> <td>0</td> <td>0</td> <td>0</td> <td>0</td> <td>0</td> <td>0</td> <td>1</td> <td>0</td> <td>0</td> <td>0</td> <td>0</td> <td>0</td> <td>0</td> <td>0</td> </tr> <tr> <td>Bit</td> <td>15</td> <td>14</td> <td>13</td> <td>12</td> <td>11</td> <td>10</td> <td>9</td> <td>8</td> <td>7</td> <td>6</td> <td>5</td> <td>4</td> <td>3</td> <td>2</td> <td>1</td> <td>0</td> </tr> </tbody> </table> <p>0 = Disable 1 = Enable</p> <p>(1) 755 drives only.</p> <p>Bit 0 "AutoOfstTest" – Enables the PM Offset test to be executed before the drive runs normally after a power cycle or drive reset. Required when the feedback device is not an absolute feedback device. Cannot be enabled if Bit 2 is enabled. Allow for up to 90° of shaft rotation. The value set in P83 [PM Ofst Tst Cur] may need to be increased to complete the test. If shaft rotation is not possible, set Bits 0 and 1 to perform a static test at every start.</p> <p>Bit 1 "Vqs Reg En" – Enables the Vqs regulator.</p> <p>Bit 2 "StaticTestEn" – Enables the Static test to be executed before the drive starts. Cannot be enabled if Bit 0 is enabled.</p> <p>Bit 3 "PMStabAnglEn" – Enables the Permanent Magnet Stability Angle regulator. Used for PM FV Encoderless when P35 [Motor Ctrl Mode] = 6 "PM FV" and P125 [Pri Vel Fdbk Sel] = Open Loop.</p> <p>Bit 4 "IPM Vqs Disa" – Disables Vqs regulator when P35 [Motor Ctrl Mode] = 10 "IPM FV."</p> <p>Bit 5 "IPMTqTrmEn" – Enables Torque Trim when P35 [Motor Ctrl Mode] = 10 "IPM FV."</p> <p>Bit 6 "VCmdPhShftEn" – Enables the enhancement function on the voltage command calculation in all control modes.</p> <p>Bit 7 "IdsCmdFFwdEn" – Enables the feed forward term calculation for the Vqs regulator in PM with feedback mode.</p> <p>Bit 8 "NoIntgHld" – This bit defines behavior of the d-q current regulator integrators. When set, the integrators will not be held during over modulation; when not set, the integrators will be held during over modulation.</p> <p>Bit 9 "NoMilimit" – When not set, modulation index will be limited based on bus utilization, when set, modulation index will not be limited.</p>							Options	Reserved	Reserved	Reserved	Reserved	Reserved	Reserved	NoMilimit	NoIntgHld	IdsCmdFFwdEn <sup>(1)</sup>	VCmdPhShftEn	IPMTqTrmEn	IPM Vqs Disa	PMStabAnglEn	StaticTestEn	Vqs Reg En	AutoOfstTest	Default	0	0	0	0	0	0	0	0	1	0	0	0	0	0	0	0	Bit	15	14	13	12	11	10	9	8	7	6	5	4	3	2	1	0									
Options	Reserved	Reserved	Reserved	Reserved	Reserved	Reserved	NoMilimit	NoIntgHld	IdsCmdFFwdEn <sup>(1)</sup>	VCmdPhShftEn	IPMTqTrmEn	IPM Vqs Disa	PMStabAnglEn	StaticTestEn	Vqs Reg En	AutoOfstTest																																																		
Default	0	0	0	0	0	0	0	0	1	0	0	0	0	0	0	0																																																		
Bit	15	14	13	12	11	10	9	8	7	6	5	4	3	2	1	0																																																		
		81	<b>PM PriEnc Offset</b> Permanent Magnet Motor Primary Encoder Offset The amount of offset between the primary feedback encoder counts, and the rotor flux center position of the PM motor. A value of 1024 is equal to 360 electrical degrees. This parameter is updated during the PM Offset test which runs at the first start after a power cycle/ system reset (P80 [PM Cfg] Bit 0 = 1) and during autotune in PM FV mode.	Default: 0 Min/Max: 0 / 1023	RW	32-bit Integer																																																												




File	Group	No.	Display Name Full Name Description	Values		Read-Write	Data Type
MOTOR CONTROL	Autotune	82	<b>PM AltEnc Offset</b> Permanent Magnet Motor Alternate Encoder Offset The amount of offset between the alternate feedback encoder counts, and the rotor flux center position of the PM motor. A value of 1024 is equal to 360 electrical degrees. This parameter is updated during the PM Offset test which runs at the first start after a power cycle/ system reset (P80 [PM Cfg] Bit 0 = 1) and during autotune in PM FV mode. Active only when Alternate Velocity Feedback is being used during Automatic Tach Switchover (see P635 [Spd Options Ctrl]).	Default: 0 Min/Max: 0 / 1023		RW	32-bit Integer
		83	 <b>PM OfstTst Cur</b> Permanent Magnet Motor Offset Test Current Amplitude of the current command in percent of the motor rated current during the PM Offset Test, which is one of the auto tune tests in PM FV mode.	Units: % Default: 40.00 Min/Max: 0.00 / 200.00		RW	Real
		84	 <b>PM OfstTst CRamp</b> Permanent Magnet Motor Offset Test Current Ramp Ramp time of the current command during the PM Offset Test in PM FV mode, which is defined as ramp time to reach the P80 [PM Cfg] current command amplitude.	Units: Secs Default: 3.00 Min/Max: 0.00 / 100.00		RW	Real
		85	 <b>PM OfstTst FRamp</b> Permanent Magnet Motor Offset Test Frequency Ramp Defines the frequency ramp time of the current command during the PM Offset Test in PM FV mode, which is defined as ramp time in seconds from 0 to 3 Hz.	Units: Secs Default: 60.00 Min/Max: 0.00 / 1000.00		RW	Real
		86	<b>PM CEMF Voltage</b> Permanent Magnet Motor Counter Electro Motive Force Counter electromotive force (CEMF) voltage displayed in line-to-line rms value, which is normalized to the base motor speed. Updated after the completion of the auto tune in PM FV mode.	Units: Volt Default: P25 [Motor NP Volts] x 0.0675 Min/Max: 0.00 / P25 [Motor NP Volts] x 1.5		RW	Real
		87	<b>PM IR Voltage</b> Permanent Magnet Motor Stator Voltage Drop Voltage across the stator resistance of the PM motor at the rated motor current displayed in line-to-line rms value. Updated after the completion of the auto tune in PM FV mode.	Units: Volt Default: Based on Drive Rating Min/Max: 0.00 / Based on Drive Rating and Voltage Class		RW	Real
		88	 <b>PM IXq Voltage</b> Permanent Magnet Motor Q-Axis Stator Inductance Voltage Drop Voltage across the q-axis stator inductance of the PM motor at the rated motor current and the rated motor frequency displayed in line-to-line rms value. This parameter is updated after the completion of the auto tune in PM FV mode.	Units: Volt Default: P25 [Motor NP Volts] x 0.0435 Min/Max: 0.00 / P25 [Motor NP Volts] x 1.5		RW	Real
		89	 <b>PM IXd Voltage</b> Permanent Magnet Motor D-Axis Stator Inductance Voltage Drop Voltage across the d-axis stator inductance of the PM motor at the rated motor current and the rated motor frequency displayed in line-to-line rms value. Updated after the completion of the auto tune in PM FV mode.	Units: Volt Default: P25 [Motor NP Volts] x 0.0435 Min/Max: 0.00 / P25 [Motor NP Volts] x 1.5		RW	Real
		91	<b>PM Vqs Reg Kp</b> Permanent Magnet Motor Vqs Regulator Proportional Gain Proportional gain of the vqs regulator in PM FV mode. When P80 [PM Cfg] Bit 1 = 1, the vqs regulator will be active either when the motor voltage exceeds the voltage limited by the DC bus voltage or when the motor voltage exceeds the value set by P36 [Maximum Voltage].	Default: 2.50 Min/Max: 0.00 / 1000.00		RW	Real
		92	<b>PM Vqs Reg Ki</b> Permanent Magnet Motor Vqs Regulator Integral Gain Integral gain of the vqs regulator in PM FV mode.	Default: 0.50 Min/Max: 0.00 / 1000.00		RW	Real
		93	<b>PM Dir Test Cur</b> Permanent Magnet Motor Direction Test Current Amount of current commanded during the direction test when P35 [Motor Ctrl Mode] option 6 "PM FV" is selected. When the Start-Up feature is used, this value is automatically set to 10% of the motor rated current.	Units: Amps Default: P26 [Motor NP Amps]/10 Min/Max: 0.00 / P26 [Motor NP Amps]		RW	Real



File	Group	No.	Display Name Full Name Description	Values		Read-Write	Data Type
				Units:	Default:		
MOTOR CONTROL	Autotune	120	<b>755 PM IXqVoltage125</b> Permanent Magnet Motor Q-Axis Stator Inductance Voltage Drop 125% Voltage across the q-axis stator inductance of the PM motor at 125% rated motor current and the rated motor frequency displayed in line-to-line rms value. This parameter is updated after the completion of the auto tune in PM FV mode.	Units: Volt Default: P25 [Motor NP Volts] x 0.0435 Min/Max: 0.0000 / P25 [Motor NP Volts] x 1.5		RW	Real
		1630	 <b>IPM_Lq_25_pct</b> Lq for 25% Iq IPM Control Sets Lq at 25% current.	Units: mH Default: 0.00 Min/Max: 0.00 / 999990.00		RW	Real
		1631	 <b>IPM_Lq_50_pct</b> Lq for 50% Iq IPM Control Sets Lq at 50% current.	Units: mH Default: 0.00 Min/Max: 0.00 / 999990.00		RW	Real
		1632	 <b>IPM_Lq_75_pct</b> Lq for 75% Iq IPM Control Sets Lq at 75% current.	Units: mH Default: 0.00 Min/Max: 0.00 / 999990.00		RW	Real
		1633	 <b>IPM_Lq_100_pct</b> Lq for 100% Iq IPM Control Sets Lq at 100% current.	Units: mH Default: 0.00 Min/Max: 0.00 / 999990.00		RW	Real
		1634	 <b>IPM_Lq_125_pct</b> Lq for 125% Iq IPM Control Sets Lq at 125% current.	Units: mH Default: 0.00 Min/Max: 0.00 / 999990.00		RW	Real
		1635	 <b>IPM_Ld_0_pct</b> Ld for 0% Id IPM Control Sets Ld at 0% current.	Units: mH Default: 0.00 Min/Max: 0.00 / 999990.00		RW	Real
		1636	 <b>IPM_Ld_100_pct</b> Ld for 100% Id IPM Control Sets Ld at 100% current.	Units: mH Default: 0.00 Min/Max: 0.00 / 999990.00		RW	Real
		1646	<b>IPM PriOffstComp</b> IPM Primary Encoder Offset Compensation Primary Offset Compensation, AutoTune group.	Default: 0 Min/Max: 0 / 512		RW	Real
		1647	<b>IPM AltOffstComp</b> IPM Alternate Encoder Offset Compensation Alternate Offset Compensation, AutoTune group.	Default: 0 Min/Max: 0 / 512		RW	Real



File	Group	No.	Display Name Full Name Description	Values		Read-Write	Data Type
MOTOR CONTROL	Vector Regulator	95	<b>VCL Cur Reg BW</b> Vector Closed Loop Current Regulator Bandwidth Sets the bandwidth of the current regulator by automatically adjusting the gains (P96 and P97) based on motor autotune results. When the value of bandwidth is zero (default) the current regulator gains can be manually adjusted. The default values for P95, P96, and P97 typically provide excellent performance, and do not normally need to be adjusted.	Units: Default: Min/Max:	R/S 0.0 0.0 / 9999.0	RW	Real
		96	<b>VCL Cur Reg Kp</b> Vector Closed Loop Current Regulator Proportional Gain Proportional gain of the current regulator. Can be adjusted when P95 is set to zero. The default values for P95, P96, and P97 typically provide excellent performance, and do not normally need to be adjusted.	Default: Min/Max:	1250.0 0.0 / 50000.0	RW	Real
		97	<b>VCL Cur Reg Ki</b> Vector Closed Loop Current Regulator Integral Gain Integral gain of the current regulator. Can be adjusted when P95 is set to zero. The default values for P95, P96, and P97 typically provide excellent performance, and do not normally need to be adjusted.	Default: Min/Max:	60.0 0.0 / 50000.0	RW	Real
		98	<b>VEncdls FReg Kp</b> Encoderless Vector Frequency Regulator Proportional Gain Represents electrical angle compensation dependent on motor cable and PWM Frequency. Determined during autotuning when P35 [Motor Ctrl Mode] is set to one of the FV modes without speed feedback.	Units: Default: Min/Max:	Hz/A 524.0 0.0 / 100000.0	RW	Real
		99	<b>VEncdls FReg Ki</b> Encoderless Vector, Frequency Regulator Integral Gain Determined during autotuning when P35 [Motor Ctrl Mode] is set to one of the FV modes without speed feedback. Represents voltage compensation dependent on motor cable and PWM Frequency.	Units: Default: Min/Max:	Hz/A 9080.0 0.0 / 100000.0	RW	Real
		100	<b>Slip Reg Enable</b> Slip Regulator Enable Enables or disables the slip frequency regulator. This selection is active only in motor control mode flux vector induction (P35 [Motor Ctrl Mode] = 3 "Induction FV") and encoder feedback is used.	Default: Options:	1 = "Enabled" 0 = "Disabled" 1 = "Enabled"	RW	32-bit Integer
		101	<b>Slip Reg Ki</b> Slip Regulator Integral Gain Integral gain for the slip frequency regulator.	Default: Min/Max:	10.00 0.00 / 10000.00	RW	Real
		102	<b>Slip Reg Kp</b> Slip Regulator Proportional Gain Proportional gain for the slip frequency regulator.	Default: Min/Max:	0.50 0.00 / 10000.00	RW	Real
		103	<b>Flux Reg Enable</b> Flux Regulator Enable Enables or disables the flux regulator. This selection is active only in motor control mode flux vector induction (P35 [Motor Ctrl Mode] = 3 "Induction FV").	Default: Options:	1 – Enabled 0 – Disabled 1 – Enabled	RW	32-bit Integer
		104	<b>Flux Reg Ki</b> Flux Regulator Integral Gain Integral gain for the flux regulator.	Default: Min/Max:	30.00 0.00 / 10000.00	RW	Real
105	<b>Flux Reg Kp</b> Flux Regulator Proportional Gain Proportional gain for the flux regulator.	Default: Min/Max:	1.00 0.00 / 10000.00	RW	Real		

File	Group	No.	Display Name Full Name Description	Values	Read-Write	Data Type
MOTOR CONTROL	Vector Regulator	106	<b>Trq Adapt Speed</b> Torque Adaption Speed Operating frequency (speed) at which the adaptive torque control regulators become active as a percent of motor nameplate frequency. As frequency (speed) increases, the torque adapter turns on at a value that is 10 % higher than the value set in this parameter. However, as frequency (speed) decreases, the torque adapter turns off at the value set in this parameter. For example: If this parameter is set to 10.00, as the frequency (speed) increases, the adapter turns on when the value of this parameter reaches 20.00. As the frequency (speed) decreases, the adapter turns off when the value of this parameter reaches 10.00. This selection is active only in motor control mode flux vector induction (P35 [Motor Ctrl Mode] = 3 "Induction FV").	Units: % Default: 10.00 Min/Max: 0.00 / 100.00	RW	Real
		107	<b>Trq Adapt En</b> Torque Adaption Enable Enables or disables the adaptive torque control. This selection is active only in motor control mode flux vector induction (P35 [Motor Ctrl Mode] = 3 "Induction FV").	Default: 1 – Enabled Options: 0 – Disabled 1 – Enabled	RW	32-bit Integer
		108	<b>Phase Delay Comp</b> Phase Delay Compensation Used to adjust the sample delay compensation gain for the current feedback. The gain compensation is scaled to the sample time (for example, +1.0 would be a compensation of positive 1 sample time).	Default: 0.00 Min/Max: –/+100.00	RW	Real
		109	<b>Trq Comp Mode</b> Torque Compensation Mode Automatic: Updates the torque compensation gains (P110 [Trq Comp Mtring] and P111 [Torque Comp Regen]) after autotune.	Default: 1 – Auto Options: 0 – Manual 1 – Auto	RW	32-bit Integer
		110	<b>Trq Comp Mtring</b> Torque Compensation Motoring Motor torque compensation applied to the torque command for motoring power. This parameter can be set manually or determined automatically during autotune. (See P109 [Trq Comp Mode].) In manual mode, a value of 5% will increase the commanded torque by 5% (gain of 1.05). This is used for flux vector motor control mode (P35 [Motor Ctrl Mode] = 3 "Induction FV").	Units: % Default: 0.00 Min/Max: –/+50.00	RW	Real
		111	<b>Trq Comp Regen</b> Torque Compensation Regeneration Motor torque compensation applied to the torque command for regenerating torque. This parameter can be set manually or determined automatically during autotune. (See P109 [Trq Comp Mode].) In manual mode, a value of -3% will decrease the commanded torque by 3% (gain of 0.97). This is used for flux vector motor control modes (P35 [Motor Ctrl Mode]).	Units: % Default: 0.00 Min/Max: –/+50.00	RW	Real
		112	<b>Slip Adapt Iqs</b> Slip Adaption Iqs Level of per unit Iqs at which the adaptive slip frequency regulator becomes active. Active when P35 [Motor Ctrl Mode] = 3 "Induction FV."	Default: 0.05 Min/Max: 0.00 / 1.00	RW	Real
		113	<b>SFAdapt SlewLmt</b> Slip and Flux Adaption Slew Limit Time that the slip, flux, and torque regulators are allowed to converge before the regulators are turned on after the motor speed reaches the level set in P106 [Trq Adapt Speed]. Active when P35 [Motor Ctrl Mode] = 3 "Induction FV."	Units: Secs Default: 0.00 Min/Max: 0.00 / 60.00	RW	Real
		114	<b>SFAdapt SlewRate</b> Slip and Flux Adaption Slew Rate Rate that the slip and flux regulators can converge before the regulators are enabled. Active when P35 [Motor Ctrl Mode] = 3 "Induction FV."	Default: 0.005 Min/Max: 0.00001 / 1.000000	RW	Real
		115	<b>SFAdapt CnvrngLvl</b> Slip and Flux Adaption Converge Level Slip and flux regulator error level that indicates convergence. Active when P35 [Motor Ctrl Mode] = 3 "Induction FV."	Default: 0.01 Min/Max: 0.00001 / 1.000000	RW	Real

File	Group	No.	Display Name Full Name Description	Values		Read-Write	Data Type
MOTOR CONTROL	Vector Regulator	116	<b>SFAdapt CnvrqLmt</b> Slip and Flux Adaption Converge Limit Duration of convergence before the adaption regulators are enabled after the error has decreased below the level set in P115 [SFAdapt CnvrqLvl]. Active when P35 [Motor Ctrl Mode] = 3 "Induction FV."	Default: Min/Max:	0.500 0.000 / 5.000	RW	Real
		120	See <a href="#">page 66</a> .				
		1629	 <b>PM Bus Prot</b> PM Motor Bus Protection Enter a value to set the maximum limit for P1641 [PM Vel Max]. The drive calculates this during Rotated Tune tests. The calculation uses measured Counter-Electro Magnetic Force (CEMF). The purpose is to protect the drive from over-voltage conditions. These can occur when a PM motor is spinning too fast while the output frequency is zero. Do not change this unless you are using an external solution for CEMF protection. One external solution is a 'crowbar' circuit.	Units: Default: Min/Max:	Hz 60 0 / 39000	RW	Real
		1637	<b>IPMVqFFwdCemf</b> IPM Vq Feed Forward CEMF Sets the percentage of the CEMF component of the feed forward voltage in Vq reference when P35 [Motor Ctrl Mode] = 10 "IPM FV."	Units: Default: Min/Max:	% 100.0 0.0 / 100.0	RW	Real
		1638	<b>IPMVqFFwdLldWe</b> IPM Vq Feed Forward LldWe Sets the percentage of the (Ld x Id x we) component of the feed forward voltage in Vq reference when P35 [Motor Ctrl Mode] = 10 "IPM FV."	Units: Default: Min/Max:	% 100.0 0.0 / 100.0	RW	Real
		1639	<b>IPMVdFFwdLlqWe</b> IPM Vd Feed Forward LlqWe Sets the percentage of the (Lq x Iq x we) component of the feed forward voltage in Vd reference when P35 [Motor Ctrl Mode] = 10 "IPM FV."	Units: Default: Min/Max:	% 100.0 0.0 / 100.0	RW	Real
		1640	 <b>IPM Max Cur</b> IPM Maximum Current Sets the current trip level.	Units: Default: Min/Max:	% 200.0 0.0 / 400.0	RW	Real
		1641	 <b>PM Vel Max</b> PM Motor Maximum Velocity Enter a value to set the maximum velocity of the PM motor. The purpose is to protect the drive from over-voltage conditions. These can occur when a PM motor is spinning too fast while the output frequency is zero. P1629 [PM Bus Prot] limits the value of this parameter. Do not change this unless you are using an external solution for CEMF protection. One external solution is a 'crowbar' circuit.	Units: Default: Min/Max:	Hz 60 0.00 / 324	RW	Real
		1642	<b>IPM TrqTrim Kp</b> Torque Trim Kp Gain for IPM Control Sets the Kp term for Torque Trim function.	Default: Min/Max:	0.10 0.00 / 100.00	RW	Real
		1643	<b>IPM TrqTrim Ki</b> Torque Trim Ki Gain for IPM Control Sets the Ki term for Torque Trim function.	Default: Min/Max:	1.00 0.00 / 100.00	RW	Real
		1644	<b>IPM TrqTrim HLim</b> Torque Trim Hi Limit for IPM Control Sets the high limit for Torque Trim function.	Default: Min/Max:	0.20 0.00 / 2.00	RW	Real
		1645	<b>IPM TrqTrim LLim</b> Torque Trim Lo Limit for IPM Control Sets the low limit for Torque Trim function.	Default: Min/Max:	-0.20 -2.00 / 0.00	RW	Real













## Drive (Port 0) Feedback & I/O File











File	Group	No.	Display Name Full Name Description	Values	Read-Write	Data Type
FEEDBACK & I/O	Feedback	125	<b>Pri Vel Fdbk Sel</b>  Primary Velocity Feedback Select Selects the source of the P3 [Mtr Vel Fdbk] and P131 [Active Vel Fdbk] that will be used when the drive is in operation without an Automatic Tach Switchover. Possible selections include: Port 0 – Open Loop Fdbk, Port 0 – Simulator Fdbk, and any Port that contains a feedback module (for example, Encoder). The Disabled and Open Loop Fdbk selections are functionally equivalent, with Open Loop being the default setting. Open Loop velocity feedback is estimated based on P1 [Output Frequency] and P5 [Torque Cur Fdbk], adjusted using P621 [Slip RPM at FLA]. Simulator Fdbk is available in the Flux Vector selections for P35 [Motor Ctrl Mode]. Simulator velocity feedback is calculated based on P690 [Limited Trq Ref] and P76 [Total Inertia]. This selection is useful for drive operational checkout and test when motor movement is undesired. In simulation mode, gating of the power inverter section of the drive is disabled. Selection of any option module port that contains an encoder module results in P3 [Mtr Vel Fdbk] based on a measured value. Data obtained from the selected feedback module will be used to determine motor velocity feedback. Primary feedback refers to the Automatic Feedback Loss Switchover option. This option will automatically switch from the primary to the alternate feedback source upon loss of the primary feedback source. If this option is not being used, then the primary feedback will always be the active feedback source. The active feedback source is typically the primary feedback.	Default: 137 Min/Max: 1 / 159999	RW	32-bit Integer
		126	<b>Pri Vel FdbkFltr</b> Primary Velocity Feedback Filter Adjusts a filter setting that is applied to the motor velocity feedback source that is selected by P125 [Pri Vel Fdbk Sel]. The purpose of this filter is to reduce the level of noise in the feedback signal. Make a selection for a value that is higher than the value in parameter 636 [Speed Reg BW]. This is moving average type filter that has a delay setting of N, where N is an integer number (0, 1, 2 . . .). A setting of zero provides no filtering and no delay. Larger values of N result in more filtering and more delay. The best setting for this filter depends on the level of noise in the feedback signal and the bandwidth setting of the velocity regulator. In the Flux Vector selections for P35 [Motor Ctrl Mode], setting P636 [Speed Reg BW] to a non-zero setting places the drive in an automatic gain/filter adjustment mode. When the drive is in this automatic adjustment mode, the value of P666 [Speed Comp Gain] and possibly P644 [Spd Err Fltr BW] are adjusted, based on the setting of P126 [Pri Vel FdbkFltr]. The automatic setting of P644 [Spd Err Fltr BW] becomes independent of the feedback filter setting when P704 [InAdp LdObs Mode] is set to 1 "InertiaAdapt."	Default: 3 – 50R/S Noise Options: 0 – 190R/S Noise 1 – 160R/S Noise 2 – 100R/S Noise 3 – 50R/S Noise 4 – 25R/S Noise 5 – 12R/S Noise 6 – 6R/S Noise 7 – 3R/S Noise	RW	32-bit Integer
		127	<b>Pri Vel Feedback</b> Primary Velocity Feedback Output of the Primary Velocity Feedback Delay filter, in units of Hz or RPM, depending on the value of P300 [Speed Units]. Adjustment of the delay filter is made using P126 [Pri Vel FdbkFltr]. The Primary Velocity Feedback is used when the drive is operating without an Automatic Tach Switchover.	Units: Hz RPM Default: 0.00 Min/Max: -/+P27 [Motor NP Hertz] -/+P28 [Motor NP RPM] x 8	RO	Real
		128	 <b>Alt Vel Fdbk Sel</b> Alternate Velocity Feedback Select Selects the source of the P3 [Mtr Vel Fdbk] and P131 [Active Vel Fdbk] to be used when the drive is in operation with an Automatic Tach Switchover. See P635 [Spd Options Ctrl], bit 7 "Auto Tach SW." Alternate feedback refers to the Automatic Feedback Loss Switchover option. This option will automatically switch from the primary to the alternate feedback source upon loss of the primary feedback source. If this option is not being used, then the primary feedback will always be the active feedback source. The active feedback source is typically the primary feedback.	Default: 137 Min/Max: 1 / 159999	RW	32-bit Integer











File	Group	No.	Display Name Full Name Description	Values	Read-Write	Data Type
FEEDBACK & I/O	Feedback	129	<b>Alt Vel FdbkFiltr</b> Alternate Velocity Feedback Filter Adjusts a filter setting that is applied to the motor velocity feedback source that is selected by P128 [Alt Vel Fdbk Sel]. The purpose of this filter is to reduce the level of noise in the feedback signal. Filter adjustment and operation is similar to P126 [Pri Vel FdbkFiltr]. Make a selection for a value that is higher than the value in parameter 648 [Alt Speed Reg BW].	Default: 3 – 50R/S Noise Options: 0 – 190R/S Noise 1 – 160R/S Noise 2 – 100R/S Noise 3 – 50R/S Noise 4 – 25R/S Noise 5 – 12R/S Noise 6 – 6R/S Noise 7 – 3R/S Noise	RW	32-bit Integer
		130	<b>Alt Vel Feedback</b> Alternate Velocity Feedback Output of the Alternate Velocity Feedback Delay filter, displayed in units of Hz or RPM, depending on the value of P300 [Speed Units]. Adjustment of the delay filter is made using P126 [Pri Vel FdbkFiltr]. The Alternate Velocity Feedback is used when the drive is operating with an Automatic Tach Switchover.	Units: Hz RPM Default: 0.00 Min/Max: -/+P27 [Motor NP Hertz] -/+P28 [Motor NP RPM] x 8	RO	Real
		131	<b>Active Vel Fdbk</b> Active Velocity Feedback Active motor velocity feedback value that used by the Flux Vector control's velocity regulator or the V/Hz and Sensorless Vector velocity regulator. This value in use is the result of the Primary/Alternate feedback selection. When the drive is operating without an Automatic Tach Switchover, then P127 [Pri Vel Feedback] is selected. When the drive is operating with an Automatic Tach Switchover, then the P130 [Alt Vel Feedback] will be selected. Status Bit 5 "FdbkLoss Sw0" will become set in P936 [Drive Status 2] when an Automatic Tach Switchover has occurred. When operation in a non-vector control mode (V/Hz or Sensorless Vector) with open loop feedback, the Active Velocity Feedback parameter value will track the value in P597 [Final Speed Ref].	Units: Hz RPM Default: 0.00 Min/Max: -/+P27 [Motor NP Hertz] -/+P28 [Motor NP RPM] x 8	RO	Real
		132	 <b>Aux Vel Fdbk Sel</b> Auxiliary Velocity Feedback Select Selects the source of the drive's P134 [Aux Vel Feedback]. Possible selections are the same as for P125 [Pri Vel Fdbk Sel]. Auxiliary feedback source is made available as a speed reference selection. It can be used when the drive's speed reference source needs to be an encoder.	Default: 137 Min/Max: 1 / 159999	RW	32-bit Integer
		133	<b>Aux Vel FdbkFiltr</b> Auxiliary Velocity Feedback Filter Adjusts a filter setting that is applied to the P134 [Aux Vel Feedback] that is selected by P132 [Aux Vel Fdbk Sel]. The purpose of this filter is to reduce the level of noise present in the feedback signal. Filter adjustment and operation is similar to P126 [Pri Vel FdbkFiltr].	Default: 3 – 50R/S Noise Options: 0 – 190R/S Noise 1 – 160R/S Noise 2 – 100R/S Noise 3 – 50R/S Noise 4 – 25R/S Noise 5 – 12R/S Noise 6 – 6R/S Noise 7 – 3R/S Noise	RW	32-bit Integer
		134	<b>Aux Vel Feedback</b> Auxiliary Velocity Feedback Output of the Auxiliary Velocity Feedback Delay filter, in units of Hz or RPM, depending on the value of P300 [Speed Units]. Adjustment of the delay filter is made using P126 [Pri Vel FdbkFiltr]. Typically used as a speed reference source. This selection is available in P545 [Spd Ref A Sel] and P550 [Spd Ref B Sel].	Units: Hz RPM Default: 0.00 Min/Max: -/+P27 [Motor NP Hertz] -/+P28 [Motor NP RPM] x 8	RO	Real
		135	 <b>Psn Fdbk Sel</b> Position Feedback Select Selects the source of P847 [Psn Fdbk]. Possible selections include: Port 0 – Simulator Fdbk, and any Port that contains a feedback module (for example, Encoder). Open Loop Feedback is not available as a Position feedback source. The default setting is P138 [Simulator Fdbk]. This is a test mode where position feedback is calculated based on P690 [Limited Trq Ref] and P76 [Total Inertia]. When position control is used, a valid position feedback source must be selected.	Default: 138 Min/Max: 1 / 159999	RW	32-bit Integer









File	Group	No.	Display Name Full Name Description	Values	Read-Write	Data Type
FEEDBACK & I/O	Feedback	136	<b>755 Load Psn FdbkSel</b> Load Position Feedback Select Selects a position load feedback source for the position control. The position load feedback P847 [Psn Fdbk] indicates the selected position feedback value. The value forms the primary feedback for the position regulator integration channel.	Default: 847 Min/Max: 1 / 159999	RW	32-bit Integer
		137	<b>Open Loop Fdbk</b> Open Loop Feedback An estimated motor feedback source that is available to any of the Velocity Feedback Selection parameters – P125 [Pri Vel Fdbk Sel], P128 [Alt Vel Fdbk Sel], and P132 [Aux Vel Fdbk Sel]. Open Loop Feedback is not available as a Position feedback source. The Open Loop Feedback's parameter value has units of encoder counts as established by P141 [Virtual Enc EPR]. Open Loop feedback is estimated based on P1 [Output Frequency] and P5 [Torque Cur Fdbk], adjusted using P621 [Slip RPM at FLA].	Default: 0 Options: -2147483648 / 2147483647	RO	32-bit Integer
		138	<b>Simulator Fdbk</b> Simulator Feedback Simulator Feedback is a calculated motor feedback source. It can be used when operating in any of the Flux Vector control modes that are selected in P35 [Motor Ctrl Mode]. Simulator Feedback is available to any of the Velocity Feedback Selection parameters: P125 [Pri Vel Fdbk Sel], P128 [Alt Vel Fdbk Sel], and P132 [Aux Vel Fdbk Sel]. Simulator Feedback is also available as a Position feedback source as selected by P135 [Psn Fdbk Sel]. The Simulator Feedback's parameter value has units of encoder counts, as established by P141 [Virtual Enc EPR]. Simulator velocity feedback is calculated based on P690 [Limited Trq Ref] and P76 [Total Inertia]. This selection is useful for drive operational checkout and test when motor movement is undesired. In simulation mode, gating of the power inverter section of the drive is disabled.	Default: 0 Options: -2147483648 / 2147483647	RO	32-bit Integer
		139	<b>755 Delayed Spd Ref</b> Delayed Speed Reference One sample period delayed output of P594 [Ramped Spd Ref]. Used in some applications to synchronize the speed reference value when controlling multiple drives. In these applications, the drive that supplies the master speed reference would use the [Delayed Spd Ref] value. Setting P635 [Spd Options Ctrl] Bit 8 "Delayed Ref" will select the delayed reference in the master drive. P594 [Ramped Spd Ref] would then be transmitted to the slave drives over a communication link.	Units: Hz RPM Default: 0.00 Min/Max: -/+P27 [Motor NP Hertz] -/+P28 [Motor NP RPM] x 8	RO	Real
		140	<b>755 Virtual EncDelay</b> Virtual Encoder Delay One sample period delayed output of P142 [Virtual Enc Psn]. Used in some applications to phase synchronize position reference through a drive communications link. The master is delayed one sample while the downstream drives update their position references – then all drives sample position simultaneously. The downstream drives do not select a delay. The selection of the delayed or non-delayed position reference is made by choosing the desired parameter in P766 [Psn Direct Stpt].	Default: 0 Options: -2147483648 / 2147483624	RO	32-bit Integer
		141	<b>755 Virtual Enc EPR</b> Virtual Encoder Edges Per Revolution Equivalent Edges Per Revolution (EPR) or line count of a virtual encoder. A virtual encoder is a position reference whose input is derived from the speed reference. It accumulates pulses at the same rate as a real encoder of identical Pulses Per Revolution (PPR). Enter the equivalent PPR. For example, enter 1024 PPR to match an encoder with 1024 EPR.	Default: 4096 Min/Max: 10 / 67108864	RW	32-bit Integer
		142	<b>755 Virtual Enc Psn</b> Virtual Encoder Position A 32 bit pulse accumulator of the virtual encoder. The accumulated pulse count is equivalent to the hardware accumulator of a real encoder. It accumulates at a rate of 4x the value placed in P141 [Virtual Enc EPR]. The accumulator starts at zero upon position enable.	Default: 0 Min/Max: -2147483648 / 2147483647	RO	32-bit Integer











File	Group	No.	Display Name Full Name Description	Values	Read-Write	Data Type	
FEEDBACK & I/O	Digin Functions	150	 <b>Digital In Cfg</b> Digital Input Configure Defines operation for DI Run type parameters. Run Edge (0) – Control function requires a rising edge (open to close transition) in order for the drive to run. Run Level (1) – Provides a run level input. Does not require a transition for enable or fault, but a transition is required for a stop. When set to 1 “Run Level” the absence of a run command is indicated as a stop asserted and parameter 935 [Drive Status 1] Bit 0 will be low.	Default: 0 – Run Edge Options: 0 – Run Edge 1 – Run Level	RW	32-bit Integer	
		 <b>ATTENTION:</b> Equipment damage and/or personal injury may result if this parameter is used in an inappropriate application. Do not use this function without considering applicable local, national and international codes, standards, regulations, or industry guidelines.					
		155	 <b>DI Enable</b> Digital Input Enable Assigns a digital input used to enable the drive.	Default: 0.00 Min/Max: 0.00 / 159999.15	RW	32-bit Integer	
		156	 <b>DI Clear Fault</b> Digital Input Clear Fault Assigns a digital input used to clear faults.	Default: 0.00 Min/Max: 0.00 / 159999.15	RW	32-bit Integer	
		157	 <b>DI Aux Fault</b> Digital Input Auxiliary Fault Assigns a digital input used to force an external auxiliary fault.	Default: 0.00 Min/Max: 0.00 / 159999.15	RW	32-bit Integer	
		158	 <b>DI Stop</b> Digital Input Stop Assigns a digital input used to issue a stop command.	Default: 0.00 Min/Max: 0.00 / 159999.15	RW	32-bit Integer	
		159	 <b>DI Cur Lmt Stop</b> Digital Input Current Limit Stop Assigns a digital input used to perform a current limited stop.	Default: 0.00 Min/Max: 0.00 / 159999.15	RW	32-bit Integer	
		160	 <b>DI Coast Stop</b> Digital Input Coast Stop Assigns a digital input used to perform a coast-to-stop.	Default: 0.00 Min/Max: 0.00 / 159999.15	RW	32-bit Integer	
		161	 <b>DI Start</b> Digital Input Start Assigns a digital input used to start the drive (3-wire control).	Default: 0.00 Min/Max: 0.00 / 159999.15	RW	32-bit Integer	
		162	 <b>DI Fwd Reverse</b> Digital Input Forward Reverse Assigns a digital input used to command reverse direction.	Default: 0.00 Min/Max: 0.00 / 159999.15	RW	32-bit Integer	
		163	 <b>DI Run</b> Digital Input Run Assigns a digital input used to run the drive (2-wire control).	Default: 0.00 Min/Max: 0.00 / 159999.15	RW	32-bit Integer	
		164	 <b>DI Run Forward</b> Digital Input Run Forward Assigns a digital input used to run the drive (2 wire control) and command forward direction.	Default: 0.00 Min/Max: 0.00 / 159999.15	RW	32-bit Integer	



File	Group	No.	Display Name Full Name Description	Values	Read-Write	Data Type																																							
FEEDBACK & I/O	Digin Functions	165	 <b>DI Run Reverse</b> Digital Input Run Reverse Assigns a digital input used to run the drive (2 wire control) and command reverse direction.	Default: 0.00 Min/Max: 0.00 / 159999.15	RW	32-bit Integer																																							
		166	 <b>DI Jog 1</b> Digital Input Jog 1 Assigns a digital input used to jog the drive at the speed of P556 [Jog Speed 1].	Default: 0.00 Min/Max: 0.00 / 159999.15	RW	32-bit Integer																																							
		167	 <b>DI Jog 1 Forward</b> Digital Input Jog 1 Forward Assigns a digital input used to jog the drive in the forward direction at the speed of P556 [Jog Speed 1].	Default: 0.00 Min/Max: 0.00 / 159999.15	RW	32-bit Integer																																							
		168	 <b>DI Jog 1 Reverse</b> Digital Input Jog 1 Reverse Assigns a digital input used to jog the drive in the reverse direction at the speed of P556 [Jog Speed 1].	Default: 0.00 Min/Max: 0.00 / 159999.15	RW	32-bit Integer																																							
		169	 <b>DI Jog 2</b> Digital Input Jog 2 Assigns a digital input used to jog the drive at the speed of P557 [Jog Speed 2].	Default: 0.00 Min/Max: 0.00 / 159999.15	RW	32-bit Integer																																							
		170	 <b>DI Jog 2 Forward</b> Digital Input Jog 2 Forward Assigns a digital input used to jog the drive in the forward direction at the speed of P557 [Jog Speed 2].	Default: 0.00 Min/Max: 0.00 / 159999.15	RW	32-bit Integer																																							
		171	 <b>DI Jog 2 Reverse</b> Digital Input Jog 2 Reverse Assigns a digital input used to jog the drive in the reverse direction at the speed of P557 [Jog Speed 2].	Default: 0.00 Min/Max: 0.00 / 159999.15	RW	32-bit Integer																																							
		172	 <b>DI Manual Ctrl</b> Digital Input Manual Control Assigns a digital input used to command manual control. Start, jog, and direction are under the digital input's exclusive control. P563 [DI ManRef Sel] is the source of the speed reference unless overwritten by P328 [Alt Man Ref Sel].	Default: 0.00 Min/Max: 0.00 / 159999.15	RW	32-bit Integer																																							
		173 174 175	 <b>DI Speed Sel 0</b> <b>DI Speed Sel 1</b> <b>DI Speed Sel 2</b> Digital Input Speed Select <i>n</i> Assigns digital inputs used to select between speed references as follows:	Default: 0.00 Min/Max: 0.00 / 159999.15	RW	32-bit Integer																																							
		<table border="1"> <thead> <tr> <th colspan="3">Input Status (1 = Input Actuated)</th> <th rowspan="2">Auto Reference Source (Parameter)</th> </tr> <tr> <th>DI Speed Sel 2</th> <th>DI Speed Sel 1</th> <th>DI Speed Sel 0</th> </tr> </thead> <tbody> <tr> <td>0</td> <td>0</td> <td>0</td> <td>Reference A (P545)</td> </tr> <tr> <td>0</td> <td>0</td> <td>1</td> <td>Reference A (P545)</td> </tr> <tr> <td>0</td> <td>1</td> <td>0</td> <td>Reference B (P550)</td> </tr> <tr> <td>0</td> <td>1</td> <td>1</td> <td>Preset Speed 3 (P573)</td> </tr> <tr> <td>1</td> <td>0</td> <td>0</td> <td>Preset Speed 4 (P574)</td> </tr> <tr> <td>1</td> <td>0</td> <td>1</td> <td>Preset Speed 5 (P575)</td> </tr> <tr> <td>1</td> <td>1</td> <td>0</td> <td>Preset Speed 6 (P576)</td> </tr> <tr> <td>1</td> <td>1</td> <td>1</td> <td>Preset Speed 7 (P577)</td> </tr> </tbody> </table>		Input Status (1 = Input Actuated)			Auto Reference Source (Parameter)	DI Speed Sel 2	DI Speed Sel 1	DI Speed Sel 0	0	0	0	Reference A (P545)	0	0	1	Reference A (P545)	0	1	0	Reference B (P550)	0	1	1	Preset Speed 3 (P573)	1	0	0	Preset Speed 4 (P574)	1	0	1	Preset Speed 5 (P575)	1	1	0	Preset Speed 6 (P576)	1	1	1	Preset Speed 7 (P577)			
		Input Status (1 = Input Actuated)			Auto Reference Source (Parameter)																																								
DI Speed Sel 2	DI Speed Sel 1	DI Speed Sel 0																																											
0	0	0	Reference A (P545)																																										
0	0	1	Reference A (P545)																																										
0	1	0	Reference B (P550)																																										
0	1	1	Preset Speed 3 (P573)																																										
1	0	0	Preset Speed 4 (P574)																																										
1	0	1	Preset Speed 5 (P575)																																										
1	1	0	Preset Speed 6 (P576)																																										
1	1	1	Preset Speed 7 (P577)																																										
176	 <b>DI HOA Start</b> Digital Input Hand-Off-Auto Start A start for a hand-off-auto configuration. A delay filter allows the start and stop signals to come from the same circuit.	Default: 0.00 Min/Max: 0.00 / 159999.15	RW	32-bit Integer																																									

File	Group	No.	Display Name Full Name Description	Values	Read-Write	Data Type																	
FEEDBACK & I/O	Digin Functions	177	 <b>DI MOP Inc</b> Digital Input Motor Operated Potentiometer Increment Assigns a digital input used to increment the MOP speed reference.	Default: 0.00 Min/Max: 0.00 / 159999.15	RW	32-bit Integer																	
		178	 <b>DI MOP Dec</b> Digital Input Motor Operated Potentiometer Decrement Assigns a digital input used to decrement the MOP speed reference.	Default: 0.00 Min/Max: 0.00 / 159999.15	RW	32-bit Integer																	
		179	 <b>DI Accel 2</b> Digital Input Acceleration 2 Assigns a digital input used to activate P536 [Accel Time 2].	Default: 0.00 Min/Max: 0.00 / 159999.15	RW	32-bit Integer																	
		180	 <b>DI Decel 2</b> Digital Input Deceleration 2 Assigns a digital input used to activate P538 [Decel Time 2].	Default: 0.00 Min/Max: 0.00 / 159999.15	RW	32-bit Integer																	
		181	 <b>DI SpTqPs Sel 0</b> <b>DI SpTqPs Sel 1</b> Digital Input Speed Torque Position Select <i>n</i> Assigns digital inputs used to select between speed, torque, and position modes. Refer to position B5 in the block diagram on <a href="#">page 436</a> for details.	Default: 0.00 Min/Max: 0.00 / 159999.15	RW	32-bit Integer																	
		<table border="1"> <thead> <tr> <th rowspan="2">Auto Reference Source (Parameter)</th> <th colspan="2">Input Status (1 = Input Actuated)</th> </tr> <tr> <th>DI Speed Sel 1</th> <th>DI Speed Sel 0</th> </tr> </thead> <tbody> <tr> <td>P309</td> <td>0</td> <td>0</td> </tr> <tr> <td>P310</td> <td>0</td> <td>1</td> </tr> <tr> <td>P311</td> <td>1</td> <td>0</td> </tr> <tr> <td>P312</td> <td>1</td> <td>1</td> </tr> </tbody> </table>		Auto Reference Source (Parameter)			Input Status (1 = Input Actuated)		DI Speed Sel 1	DI Speed Sel 0	P309	0	0	P310	0	1	P311	1	0	P312	1	1	
		Auto Reference Source (Parameter)					Input Status (1 = Input Actuated)																
				DI Speed Sel 1			DI Speed Sel 0																
		P309		0			0																
		P310	0	1																			
		P311	1	0																			
		P312	1	1																			
185	 <b>DI Stop Mode B</b> Digital Input Stop Mode B Assigns a digital input used to activate P371 [Stop Mode B].	Default: 0.00 Min/Max: 0.00 / 159999.15	RW	32-bit Integer																			
186	 <b>DI BusReg Mode B</b> Digital Input Bus Regulation Mode B Assigns a digital input used to activate P373 [Bus Reg Mode B].	Default: 0.00 Min/Max: 0.00 / 159999.15	RW	32-bit Integer																			
187	 <b>DI PwrLoss ModeB</b> Digital Input Power Loss Mode B Assigns a digital input used to activate P453 [Pwr Loss Mode B].	Default: 0.00 Min/Max: 0.00 / 159999.15	RW	32-bit Integer																			
188	 <b>DI Pwr Loss</b> Digital Input Power Loss Assigns a digital input used to force a power loss condition.	Default: 0.00 Min/Max: 0.00 / 159999.15	RW	32-bit Integer																			
189	 <b>DI Precharge</b> Digital Input Precharge This input is useful only on common bus inverters (DC input drives). It indicates when the drive is disconnected and connected to the DC bus. Its purpose is to avoid large inrush currents that would normally occur if the drive were connected to the DC bus without being in the precharge state. Resetting (de-energizing) the input, indicates that the drive is disconnected from the DC bus. When the input is reset, the drive enters the precharge state and performs a coast to stop. Setting (energizing) the input indicates that the drives is connected to the DC bus. When the input is set, the drive returns to its normal precharge state and start/run control.	Default: 0.00 Min/Max: 0.00 / 159999.15	RW	32-bit Integer																			

File	Group	No.	Display Name Full Name Description	Values		Read-Write	Data Type
				Default:	Min/Max:		
FEEDBACK & I/O	Digin Functions	190	<b>DI Prchrg Seal</b>  Digital Input Precharge Seal Assigns a digital input used to force a unique fault when an external precharge circuit opens.	Default: 0.00 Min/Max: 0.00 / 159999.15		RW	32-bit Integer
		191	<b>DI PID Enable</b>  Digital Input Proportional Integral Derivative Enable Assigns a digital input used to activate the Process PID control.	Default: 0.00 Min/Max: 0.00 / 159999.15		RW	32-bit Integer
		192	<b>DI PID Hold</b>  Digital Input Proportional Integral Derivative Hold Assigns a digital input used to hold the Process PID integrator.	Default: 0.00 Min/Max: 0.00 / 159999.15		RW	32-bit Integer
		193	<b>DI PID Reset</b>  Digital Input Proportional Integral Derivative Reset Assigns a digital input used to reset the Process PID integrator.	Default: 0.00 Min/Max: 0.00 / 159999.15		RW	32-bit Integer
		194	<b>DI PID Invert</b>  Digital Input Proportional Integral Derivative Invert Assigns a digital input used to invert the output of the Process PID control.	Default: 0.00 Min/Max: 0.00 / 159999.15		RW	32-bit Integer
		195	<b>DI Torque StptA</b>  Digital Input Torque Setpoint A Assigns a digital input used to force P676 [Trq Ref A Stpt] as the source for Torque Reference A, regardless of the setting in P675 [Trq Ref A Sel]. Used when the drive is in a mode that is commanding torque (see P309...P312).	Default: 0.00 Min/Max: 0.00 / 159999.15		RW	32-bit Integer
		196	<b>DI Fwd End Limit</b>  Digital Input Forward End Limit Assigns a digital input used to trigger a Forward End Limit. The resulting action depends on whether the drive is operating as a speed, torque or position regulator. The mode of operation is indicated by parameter 935 [Drive Status 1] Bit 21 "Speed Mode," Bit 22 "PositionMode," and Bit 23 "Torque Mode." When the drive is operating as a speed regulator, the resulting action is to execute a "Fast Stop" command. After the drive stops in this case, a Start command in the same direction will only allow 0 Hz to be commanded. A Start in the opposite direction will allow motion with a speed command from the selected speed reference. This function is usually used with a limit switch near the point at which the drive should stop. When the drive is operating as a torque regulator, the resulting action is to execute a "Fast Stop" command. After the drive stops in this case, it will restart and continue operation (if given a new start command). When the drive is operating as a position regulator, the resulting action is to execute a "Fast Stop" command. After the drive stops in this case, it will restart and continue to move towards the position reference (if given a new start command).	Default: 0.00 Min/Max: 0.00 / 159999.15		RW	32-bit Integer
		197	<b>DI Fwd Dec Limit</b>  Digital Input Forward Deceleration Limit Assigns a digital input used to trigger a Forward Decel Limit. The resulting action depends on whether the drive is operating as a speed, torque or position regulator. The mode of operation is indicated by parameter 935 [Drive Status 1] Bit 21 "Speed Mode," Bit 22 "PositionMode" and Bit 23 "Torque Mode." When the drive is operating as a speed regulator, the resulting action is to override the speed reference and decelerate to Preset Speed 1. This function is usually used with a limit switch and initiates the slowing down process prior to encountering the End Limit. When the drive is operating as a torque regulator, the drive ignores this signal and continues operating at its torque reference. When the drive is operating as a position regulator, the drive ignores this signal and continues moving towards its position reference.	Default: 0.00 Min/Max: 0.00 / 159999.15		RW	32-bit Integer

File	Group	No.	Display Name Full Name Description	Values		Read-Write	Data Type
FEEDBACK & I/O	Digin Functions	198	<b>DI Rev End Limit</b>  Digital Input Reverse End Limit  Assigns a digital input used to trigger a Reverse End Limit. The resulting action depends on whether the drive is operating as a speed, torque or position regulator. The mode of operation is indicated by parameter 935 [Drive Status 1] Bit 21 "Speed Mode," Bit 22 "PositionMode" and Bit 23 "Torque Mode." When the drive is operating as a speed regulator, the resulting action is to execute a "Fast Stop" command. After the drive stops in this case, a Start command in the same direction will only allow 0 Hz to be commanded. A Start in the opposite direction will allow motion with a speed command from the selected speed reference. This function is usually used with a limit switch near the point at which the drive should stop. When the drive is operating as a torque regulator, the resulting action is to execute a "Fast Stop" command. After the drive stops in this case, it will restart and continue operation (if given a new start command). When the drive is operating as a position regulator, the resulting action is to execute a "Fast Stop" command. After the drive stops in this case, it will restart and continue to move towards the position reference (if given a new start command).	Default:	0.00	RW	32-bit Integer
		Min/Max:	0.00 / 159999.15				
		199	<b>DI Rev Dec Limit</b>  Digital Input Reverse Deceleration Limit  Assigns a digital input used to trigger a Reverse Decel Limit. The resulting action depends on whether the drive is operating as a speed, torque or position regulator. The mode of operation is indicated by parameter 935 [Drive Status 1] Bit 21 "Speed Mode," Bit 22 "PositionMode" and Bit 23 "Torque Mode." When the drive is operating as a speed regulator, the resulting action is to override the speed reference and decelerate to Preset Speed 1. This function is usually used with a limit switch and initiates the slowing down process prior to encountering the End Limit. When the drive is operating as a torque regulator, the drive ignores this signal and continues operating at its torque reference. When the drive is operating as a position regulator, the drive ignores this signal and continues moving towards its position reference.	Default:	0.00	RW	32-bit Integer
		Min/Max:	0.00 / 159999.15				
200	<b>DI PHdwr OvrTrvl</b>  Digital Input Positive Hardware Over Travel  Assigns a digital input used to trigger a Positive Hardware Over-travel. The resulting action is to immediately fault and produce zero torque. After the drive is stopped, the condition will need to be cleared and the fault will need to be reset. The drive will restart (if given a new start command), and continue operation. It will follow any speed reference, position reference or torque reference. The drive's direction is not modified or limited after the restart.	Default:	0.00	RW	32-bit Integer		
Min/Max:	0.00 / 159999.15						
201	<b>DI NHdwr OvrTrvl</b>  Digital Input Negative Hardware Over Travel  Assigns a digital input used to trigger a Negative Hardware Over-travel. The resulting action is to immediately fault and produce zero torque. After the drive is stopped, the condition will need to be cleared and the fault will need to be reset. The drive will restart (if given a new start command), and continue operation. It will follow any speed reference, position reference or torque reference. The drive's direction is not modified or limited after the restart.	Default:	0.00	RW	32-bit Integer		
Min/Max:	0.00 / 159999.15						

File	Group	No.	Display Name Full Name Description	Values	Read-Write	Data Type																																																			
FEEDBACK & I/O	Control Board IO	220	<b>755 Digital In Sts</b> Digital Input Status Status of the digital input resident on the main control board (Port 0).  Options <table border="1"> <tr> <td>Reserved</td><td>Reserved</td><td>Reserved</td><td>Reserved</td><td>Reserved</td><td>Reserved</td><td>Reserved</td><td>Reserved</td><td>Reserved</td><td>Reserved</td><td>Reserved</td><td>Reserved</td><td>Reserved</td><td>Reserved</td><td>Reserved</td><td>Reserved</td><td>Digital In 0</td> </tr> <tr> <td>Default</td><td>0</td><td>0</td><td>0</td><td>0</td><td>0</td><td>0</td><td>0</td><td>0</td><td>0</td><td>0</td><td>0</td><td>0</td><td>0</td><td>0</td><td>0</td><td>0</td> </tr> <tr> <td>Bit</td><td>15</td><td>14</td><td>13</td><td>12</td><td>11</td><td>10</td><td>9</td><td>8</td><td>7</td><td>6</td><td>5</td><td>4</td><td>3</td><td>2</td><td>1</td><td>0</td> </tr> </table>	Reserved	Reserved	Reserved	Reserved	Reserved	Reserved	Reserved	Reserved	Reserved	Reserved	Reserved	Reserved	Reserved	Reserved	Reserved	Reserved	Digital In 0	Default	0	0	0	0	0	0	0	0	0	0	0	0	0	0	0	0	Bit	15	14	13	12	11	10	9	8	7	6	5	4	3	2	1	0	0 = Condition False 1 = Condition True	RO	16-bit Integer
		Reserved	Reserved	Reserved	Reserved	Reserved	Reserved	Reserved	Reserved	Reserved	Reserved	Reserved	Reserved	Reserved	Reserved	Reserved	Reserved	Digital In 0																																							
Default	0	0	0	0	0	0	0	0	0	0	0	0	0	0	0	0																																									
Bit	15	14	13	12	11	10	9	8	7	6	5	4	3	2	1	0																																									

File	Group	No.	Display Name Full Name Description	Values	Read-Write	Data Type																																																	
FEEDBACK & I/O	Digital Inputs	220	<b>753 Digital In Sts</b> Digital Input Status Status of the digital inputs resident on the main control board (Port 0).  Options <table border="1"> <tr> <td>Reserved</td><td>Reserved</td><td>Reserved</td><td>Reserved</td><td>Reserved</td><td>Reserved</td><td>Reserved</td><td>Reserved</td><td>Reserved</td><td>Reserved</td><td>Reserved</td><td>Reserved</td><td>Reserved</td><td>Digital In 2</td><td>Digital In 1</td><td>Digital In 0</td> </tr> <tr> <td>Default</td><td>0</td><td>0</td><td>0</td><td>0</td><td>0</td><td>0</td><td>0</td><td>0</td><td>0</td><td>0</td><td>0</td><td>0</td><td>0</td><td>0</td><td>0</td> </tr> <tr> <td>Bit</td><td>15</td><td>14</td><td>13</td><td>12</td><td>11</td><td>10</td><td>9</td><td>8</td><td>7</td><td>6</td><td>5</td><td>4</td><td>3</td><td>2</td><td>1</td><td>0</td> </tr> </table>	Reserved	Reserved	Reserved	Reserved	Reserved	Reserved	Reserved	Reserved	Reserved	Reserved	Reserved	Reserved	Reserved	Digital In 2	Digital In 1	Digital In 0	Default	0	0	0	0	0	0	0	0	0	0	0	0	0	0	0	Bit	15	14	13	12	11	10	9	8	7	6	5	4	3	2	1	0	0 = Condition False 1 = Condition True	RO	16-bit Integer
		Reserved	Reserved	Reserved	Reserved	Reserved	Reserved	Reserved	Reserved	Reserved	Reserved	Reserved	Reserved	Reserved	Digital In 2	Digital In 1	Digital In 0																																						
		Default	0	0	0	0	0	0	0	0	0	0	0	0	0	0	0																																						
Bit	15	14	13	12	11	10	9	8	7	6	5	4	3	2	1	0																																							
222	 <b>753 Dig In Filt Mask</b> Digital Input Filter Mask Filters the selected digital input. <b>Important:</b> Only used by the PowerFlex 753 main control board.  Options <table border="1"> <tr> <td>Reserved</td><td>Reserved</td><td>Reserved</td><td>Reserved</td><td>Reserved</td><td>Reserved</td><td>Reserved</td><td>Reserved</td><td>Reserved</td><td>Reserved</td><td>Reserved</td><td>Reserved</td><td>Reserved</td><td>Input 2</td><td>Input 1</td><td>Reserved</td> </tr> <tr> <td>Default</td><td>0</td><td>0</td><td>0</td><td>0</td><td>0</td><td>0</td><td>0</td><td>0</td><td>0</td><td>0</td><td>0</td><td>0</td><td>0</td><td>0</td><td>0</td> </tr> <tr> <td>Bit</td><td>15</td><td>14</td><td>13</td><td>12</td><td>11</td><td>10</td><td>9</td><td>8</td><td>7</td><td>6</td><td>5</td><td>4</td><td>3</td><td>2</td><td>1</td><td>0</td> </tr> </table>	Reserved	Reserved	Reserved	Reserved	Reserved	Reserved	Reserved	Reserved	Reserved	Reserved	Reserved	Reserved	Reserved	Input 2	Input 1	Reserved	Default	0	0	0	0	0	0	0	0	0	0	0	0	0	0	0	Bit	15	14	13	12	11	10	9	8	7	6	5	4	3	2	1	0	0 = Condition False 1 = Condition True	RW	16-bit Integer		
Reserved	Reserved	Reserved	Reserved	Reserved	Reserved	Reserved	Reserved	Reserved	Reserved	Reserved	Reserved	Reserved	Input 2	Input 1	Reserved																																								
Default	0	0	0	0	0	0	0	0	0	0	0	0	0	0	0																																								
Bit	15	14	13	12	11	10	9	8	7	6	5	4	3	2	1	0																																							
223	 <b>753 Dig In Filt</b> Digital Input Filter Sets the amount of filtering on the digital inputs. <b>Important:</b> Only used by the PowerFlex 753 main control board.	Units: mS Default: 4 Min/Max: 2 / 10	RW	Real																																																			

File	Group	No.	Display Name Full Name Description	Values	Read-Write	Data Type																																																			
FEEDBACK & I/O	Digital Outputs	225	<b>753 Dig Out Sts</b> Digital Output Status Status of the digital outputs.  Options <table border="1"> <tr> <td></td> <td>Reserved</td><td>Reserved</td><td>Reserved</td><td>Reserved</td><td>Reserved</td><td>Reserved</td><td>Reserved</td><td>Reserved</td><td>Reserved</td><td>Reserved</td><td>Reserved</td><td>Reserved</td><td>Reserved</td><td>Reserved</td><td>Trans Out 0</td><td>Relay Out 0</td> </tr> <tr> <td>Default</td> <td>0</td><td>0</td><td>0</td><td>0</td><td>0</td><td>0</td><td>0</td><td>0</td><td>0</td><td>0</td><td>0</td><td>0</td><td>0</td><td>0</td><td>0</td><td>0</td> </tr> <tr> <td>Bit</td> <td>15</td><td>14</td><td>13</td><td>12</td><td>11</td><td>10</td><td>9</td><td>8</td><td>7</td><td>6</td><td>5</td><td>4</td><td>3</td><td>2</td><td>1</td><td>0</td> </tr> </table>		Reserved	Reserved	Reserved	Reserved	Reserved	Reserved	Reserved	Reserved	Reserved	Reserved	Reserved	Reserved	Reserved	Reserved	Trans Out 0	Relay Out 0	Default	0	0	0	0	0	0	0	0	0	0	0	0	0	0	0	0	Bit	15	14	13	12	11	10	9	8	7	6	5	4	3	2	1	0	0 = Condition False 1 = Condition True	RO	16-bit Integer
			Reserved	Reserved	Reserved	Reserved	Reserved	Reserved	Reserved	Reserved	Reserved	Reserved	Reserved	Reserved	Reserved	Reserved	Trans Out 0	Relay Out 0																																							
		Default	0	0	0	0	0	0	0	0	0	0	0	0	0	0	0	0																																							
		Bit	15	14	13	12	11	10	9	8	7	6	5	4	3	2	1	0																																							
		226	<b>753 Dig Out Invert</b> Digital Output Invert Inverts the selected digital output.  Options <table border="1"> <tr> <td></td> <td>Reserved</td><td>Reserved</td><td>Reserved</td><td>Reserved</td><td>Reserved</td><td>Reserved</td><td>Reserved</td><td>Reserved</td><td>Reserved</td><td>Reserved</td><td>Reserved</td><td>Reserved</td><td>Reserved</td><td>Reserved</td><td>Trans Out 0</td><td>Relay Out 0</td> </tr> <tr> <td>Default</td> <td>0</td><td>0</td><td>0</td><td>0</td><td>0</td><td>0</td><td>0</td><td>0</td><td>0</td><td>0</td><td>0</td><td>0</td><td>0</td><td>0</td><td>0</td><td>0</td> </tr> <tr> <td>Bit</td> <td>15</td><td>14</td><td>13</td><td>12</td><td>11</td><td>10</td><td>9</td><td>8</td><td>7</td><td>6</td><td>5</td><td>4</td><td>3</td><td>2</td><td>1</td><td>0</td> </tr> </table>		Reserved	Reserved	Reserved	Reserved	Reserved	Reserved	Reserved	Reserved	Reserved	Reserved	Reserved	Reserved	Reserved	Reserved	Trans Out 0	Relay Out 0	Default	0	0	0	0	0	0	0	0	0	0	0	0	0	0	0	0	Bit	15	14	13	12	11	10	9	8	7	6	5	4	3	2	1	0	0 = Condition False 1 = Condition True	RW	16-bit Integer
			Reserved	Reserved	Reserved	Reserved	Reserved	Reserved	Reserved	Reserved	Reserved	Reserved	Reserved	Reserved	Reserved	Reserved	Trans Out 0	Relay Out 0																																							
Default	0	0	0	0	0	0	0	0	0	0	0	0	0	0	0	0																																									
Bit	15	14	13	12	11	10	9	8	7	6	5	4	3	2	1	0																																									
227	<b>753 Dig Out Setpoint</b> Digital Output Setpoint Controls Relay or Transistor Outputs when chosen as the source. Can be used to control outputs from a communication device using DataLinks.  Options <table border="1"> <tr> <td></td> <td>Reserved</td><td>Reserved</td><td>Reserved</td><td>Reserved</td><td>Reserved</td><td>Reserved</td><td>Reserved</td><td>Reserved</td><td>Reserved</td><td>Reserved</td><td>Reserved</td><td>Reserved</td><td>Reserved</td><td>Reserved</td><td>Trans Out 0</td><td>Relay Out 0</td> </tr> <tr> <td>Default</td> <td>0</td><td>0</td><td>0</td><td>0</td><td>0</td><td>0</td><td>0</td><td>0</td><td>0</td><td>0</td><td>0</td><td>0</td><td>0</td><td>0</td><td>0</td><td>0</td> </tr> <tr> <td>Bit</td> <td>15</td><td>14</td><td>13</td><td>12</td><td>11</td><td>10</td><td>9</td><td>8</td><td>7</td><td>6</td><td>5</td><td>4</td><td>3</td><td>2</td><td>1</td><td>0</td> </tr> </table>		Reserved	Reserved	Reserved	Reserved	Reserved	Reserved	Reserved	Reserved	Reserved	Reserved	Reserved	Reserved	Reserved	Reserved	Trans Out 0	Relay Out 0	Default	0	0	0	0	0	0	0	0	0	0	0	0	0	0	0	0	Bit	15	14	13	12	11	10	9	8	7	6	5	4	3	2	1	0	0 = Condition False 1 = Condition True	RW	16-bit Integer		
	Reserved	Reserved	Reserved	Reserved	Reserved	Reserved	Reserved	Reserved	Reserved	Reserved	Reserved	Reserved	Reserved	Reserved	Trans Out 0	Relay Out 0																																									
Default	0	0	0	0	0	0	0	0	0	0	0	0	0	0	0	0																																									
Bit	15	14	13	12	11	10	9	8	7	6	5	4	3	2	1	0																																									
230	<b>753 R00 Sel</b> Relay Output 0 Select Selects the source that will energize the relay output. Any status parameter bit can be used as an output source. For example P935 [Drive Status 1] Bit 7 "Faulted."	Default: 0 Min/Max: 0 / 159999.15	RW	32-bit Integer																																																					
231	<b>753 R00 Level Sel</b> Relay Output 0 Level Select Selects the source of the level that will be compared.	Default: 0 Min/Max: 0 / 159999	RW	32-bit Integer																																																					
232	<b>753 R00 Level</b> Relay Output 0 Level Sets the level compare value.	Default: 0.0 Min/Max: -/+1000000.0	RW	Real																																																					

File	Group	No.	Display Name Full Name Description	Values	Read-Write	Data Type																																																						
FEEDBACK & I/O	Digital Outputs	233	<b>753 R00 Level CmpSts</b> Relay Output 0 Level Compensation Status  Status of the level compare, and a possible source for a relay or transistor output. Relay Output <i>n</i> Select or Transistor Output <i>n</i> Select must have this selected to energize the output. Can be used without a physical output as status information only.  Options <table border="1"> <tr> <td></td> <td>Reserved</td> <td>Reserved</td> <td>Reserved</td> <td>Reserved</td> <td>Reserved</td> <td>Reserved</td> <td>Reserved</td> <td>Reserved</td> <td>Reserved</td> <td>Reserved</td> <td>Reserved</td> <td>Reserved</td> <td>Reserved</td> <td>AbsGrtThanEq</td> <td>Abs Less Than</td> <td>Grt Than Equ</td> <td>Less Than</td> </tr> <tr> <td>Default</td> <td>0</td> <td>0</td> <td>0</td> <td>0</td> <td>0</td> <td>0</td> <td>0</td> <td>0</td> <td>0</td> <td>0</td> <td>0</td> <td>0</td> <td>0</td> <td>0</td> <td>0</td> <td>0</td> <td>0</td> </tr> <tr> <td>Bit</td> <td>15</td> <td>14</td> <td>13</td> <td>12</td> <td>11</td> <td>10</td> <td>9</td> <td>8</td> <td>7</td> <td>6</td> <td>5</td> <td>4</td> <td>3</td> <td>2</td> <td>1</td> <td>0</td> <td></td> </tr> </table> 0 = Condition False 1 = Condition True  Bit 0 "Less Than" – Level source is less than the level value. Bit 1 "Grt Than Equ" – Level source is greater than or equal to the level value. Bit 2 "Abs Less Than" – Absolute value of the level source is less than the absolute value of the level value. Bit 3 "AbsGrtThanEq" – Absolute value of the level source is greater than or equal to the absolute value of the level value.		Reserved	Reserved	Reserved	Reserved	Reserved	Reserved	Reserved	Reserved	Reserved	Reserved	Reserved	Reserved	Reserved	AbsGrtThanEq	Abs Less Than	Grt Than Equ	Less Than	Default	0	0	0	0	0	0	0	0	0	0	0	0	0	0	0	0	0	Bit	15	14	13	12	11	10	9	8	7	6	5	4	3	2	1	0			RO	16-bit Integer
			Reserved	Reserved	Reserved	Reserved	Reserved	Reserved	Reserved	Reserved	Reserved	Reserved	Reserved	Reserved	Reserved	AbsGrtThanEq	Abs Less Than	Grt Than Equ	Less Than																																									
		Default	0	0	0	0	0	0	0	0	0	0	0	0	0	0	0	0	0																																									
		Bit	15	14	13	12	11	10	9	8	7	6	5	4	3	2	1	0																																										
		234	<b>753 R00 On Time</b> Relay Output 0 On Time Sets the "ON Delay" time for the digital outputs. This is the time between the occurrence of a condition and activation of the relay.	Units: Secs Default: 0.00 Min/Max: 0.00 / 600.00	RW	Real																																																						
		235	<b>753 R00 Off Time</b> Relay Output 0 Off Time Sets the "OFF Delay" time for the digital outputs. This is the time between the disappearance of a condition and de-activation of the relay.	Units: Secs Default: 0.00 Min/Max: 0.00 / 600.00	RW	Real																																																						
		240	<b>753 T00 Sel</b> Transistor Output 0 Select Selects the source that will energize the relay or transistor output. Any status parameter bit can be used as an output source. For example P935 [Drive Status 1] Bit 7 "Faulted."	Default: 0 Min/Max: 0 / 159999.15	RW	32-bit Integer																																																						
241	<b>753 T00 Level Sel</b> Transistor Output 0 Level Select Selects the source of the level that will be compared.	Default: 0 Min/Max: 0 / 159999	RW	32-bit Integer																																																								
242	<b>753 T00 Level</b> Transistor Output 0 Level Sets the level compare value.	Default: 0.0 Min/Max: -/+1000000.0	RW	Real																																																								
		243	<b>753 T00 Level CmpSts</b> Transistor Output 0 Level Compensation Status  Status of the level compare, and a possible source for the transistor output. Transistor Output 0 Select must have this selected to energize the output. Can be used without a physical output as status information only.  Options <table border="1"> <tr> <td></td> <td>Reserved</td> <td>Reserved</td> <td>Reserved</td> <td>Reserved</td> <td>Reserved</td> <td>Reserved</td> <td>Reserved</td> <td>Reserved</td> <td>Reserved</td> <td>Reserved</td> <td>Reserved</td> <td>Reserved</td> <td>Reserved</td> <td>AbsGrtThanEq</td> <td>Abs Less Than</td> <td>Grt Than Equ</td> <td>Less Than</td> </tr> <tr> <td>Default</td> <td>0</td> <td>0</td> <td>0</td> <td>0</td> <td>0</td> <td>0</td> <td>0</td> <td>0</td> <td>0</td> <td>0</td> <td>0</td> <td>0</td> <td>0</td> <td>0</td> <td>0</td> <td>0</td> <td>0</td> </tr> <tr> <td>Bit</td> <td>15</td> <td>14</td> <td>13</td> <td>12</td> <td>11</td> <td>10</td> <td>9</td> <td>8</td> <td>7</td> <td>6</td> <td>5</td> <td>4</td> <td>3</td> <td>2</td> <td>1</td> <td>0</td> <td></td> </tr> </table> 0 = Condition False 1 = Condition True  Bit 0 "Less Than" – Level source is less than the level value. Bit 1 "Grt Than Equ" – Level source is greater than or equal to the level value. Bit 2 "Abs Less Than" – Absolute value of the level source is less than the absolute value of the level value. Bit 3 "AbsGrtThanEq" – Absolute value of the level source is greater than or equal to the absolute value of the level value.		Reserved	Reserved	Reserved	Reserved	Reserved	Reserved	Reserved	Reserved	Reserved	Reserved	Reserved	Reserved	Reserved	AbsGrtThanEq	Abs Less Than	Grt Than Equ	Less Than	Default	0	0	0	0	0	0	0	0	0	0	0	0	0	0	0	0	0	Bit	15	14	13	12	11	10	9	8	7	6	5	4	3	2	1	0			RO	16-bit Integer
	Reserved	Reserved	Reserved	Reserved	Reserved	Reserved	Reserved	Reserved	Reserved	Reserved	Reserved	Reserved	Reserved	AbsGrtThanEq	Abs Less Than	Grt Than Equ	Less Than																																											
Default	0	0	0	0	0	0	0	0	0	0	0	0	0	0	0	0	0																																											
Bit	15	14	13	12	11	10	9	8	7	6	5	4	3	2	1	0																																												



File	Group	No.	Display Name Full Name Description	Values	Read-Write	Data Type
FEEDBACK & I/O	Digital Outputs	244	<b>753 TOO On Time</b> Transistor Output 0 On Time Sets the "ON Delay" time for the digital outputs. This is the time between the occurrence of a condition and activation of the relay or transistor.	Units: Secs Default: 0 Min/Max: 0 / 159999	RW	32-bit Integer
		245	<b>753 TOO Off Time</b> Transistor Output 0 Off Time Sets the "OFF Delay" time for the digital outputs. This is the time between the disappearance of a condition and de-activation of the relay or transistor.	Units: Secs Default: 0.0 Min/Max: -/+1000000.0	RW	Real

File	Group	No.	Display Name Full Name Description	Values	Read-Write	Data Type																																																	
FEEDBACK & I/O	Motor PTC	250	<b>753 PTC Cfg</b> Positive Temperature Coefficient Configuration Sets the action that will be taken when the PTC is indicating over temperature. "Ignore" (0) – No action is taken. "Alarm" (1) – Type 1 alarm indicated. "Flt Minor" (2) – Minor fault indicated. If running, drive continues to run. Enable with P950 [Minor Flt Cfg]. If not enabled, acts like a major fault. "FltCoastStop" (3) – Major fault indicated. Coast to Stop. "Flt RampStop" (4) – Major fault indicated. Ramp to Stop. "Flt CL Stop" (5) – Major fault indicated. Current Limit Stop.	Default: 0 – Ignore Options: 0 – Ignore 1 – Alarm 2 Flt Minor 3 FltCoastStop 4 Flt RampStop 5 Flt CL Stop	RW	32-bit Integer																																																	
		251	<b>753 PTC Sts</b> Positive Temperature Coefficient Status Status of the PTC.  Options	<table border="1"> <tr> <td>Reserved</td><td>Reserved</td><td>Reserved</td><td>Reserved</td><td>Reserved</td><td>Reserved</td><td>Reserved</td><td>Reserved</td><td>Reserved</td><td>Reserved</td><td>Reserved</td><td>Reserved</td><td>Reserved</td><td>Reserved</td><td>Over Temp</td><td>Reserved</td><td>PTC Ok</td> </tr> <tr> <td>0</td><td>0</td><td>0</td><td>0</td><td>0</td><td>0</td><td>0</td><td>0</td><td>0</td><td>0</td><td>0</td><td>0</td><td>0</td><td>0</td><td>0</td><td>0</td><td>0</td> </tr> <tr> <td>Bit</td><td>15</td><td>14</td><td>13</td><td>12</td><td>11</td><td>10</td><td>9</td><td>8</td><td>7</td><td>6</td><td>5</td><td>4</td><td>3</td><td>2</td><td>1</td><td>0</td> </tr> </table> <p>0 = Condition False 1 = Condition True</p> <p>Bit 0 "PTC Ok" – PTC is within the acceptable temperature range. Bit 2 "Over Temp" – PTC is indicating over temperature</p>	Reserved	Reserved	Reserved	Reserved	Reserved	Reserved	Reserved	Reserved	Reserved	Reserved	Reserved	Reserved	Reserved	Reserved	Over Temp	Reserved	PTC Ok	0	0	0	0	0	0	0	0	0	0	0	0	0	0	0	0	0	Bit	15	14	13	12	11	10	9	8	7	6	5	4	3	2	1	0
Reserved	Reserved	Reserved	Reserved	Reserved	Reserved	Reserved	Reserved	Reserved	Reserved	Reserved	Reserved	Reserved	Reserved	Over Temp	Reserved	PTC Ok																																							
0	0	0	0	0	0	0	0	0	0	0	0	0	0	0	0	0																																							
Bit	15	14	13	12	11	10	9	8	7	6	5	4	3	2	1	0																																							

File	Group	No.	Display Name Full Name Description	Values	Read-Write	Data Type																																																	
FEEDBACK & I/O	Analog Inputs	255	<b>753 Anlg In Type</b> Analog Input Type Status of the analog input mode set by Jumper J4 on the main control board. Refer to the PowerFlex 750-Series AC Drives Installation Instructions, publication <a href="#">750-IN001</a> , for jumper locations and positions.  Options	<table border="1"> <tr> <td>Reserved</td><td>Reserved</td><td>Reserved</td><td>Reserved</td><td>Reserved</td><td>Reserved</td><td>Reserved</td><td>Reserved</td><td>Reserved</td><td>Reserved</td><td>Reserved</td><td>Reserved</td><td>Reserved</td><td>Reserved</td><td>Reserved</td><td>Analog</td> </tr> <tr> <td>0</td><td>0</td><td>0</td><td>0</td><td>0</td><td>0</td><td>0</td><td>0</td><td>0</td><td>0</td><td>0</td><td>0</td><td>0</td><td>0</td><td>0</td><td>0</td> </tr> <tr> <td>Bit</td><td>15</td><td>14</td><td>13</td><td>12</td><td>11</td><td>10</td><td>9</td><td>8</td><td>7</td><td>6</td><td>5</td><td>4</td><td>3</td><td>2</td><td>1</td><td>0</td> </tr> </table> <p>0 = Voltage Mode 1 = Current Mode</p>	Reserved	Reserved	Reserved	Reserved	Reserved	Reserved	Reserved	Reserved	Reserved	Reserved	Reserved	Reserved	Reserved	Reserved	Reserved	Analog	0	0	0	0	0	0	0	0	0	0	0	0	0	0	0	0	Bit	15	14	13	12	11	10	9	8	7	6	5	4	3	2	1	0	RO	16-bit Integer
Reserved	Reserved	Reserved	Reserved	Reserved	Reserved	Reserved	Reserved	Reserved	Reserved	Reserved	Reserved	Reserved	Reserved	Reserved	Analog																																								
0	0	0	0	0	0	0	0	0	0	0	0	0	0	0	0																																								
Bit	15	14	13	12	11	10	9	8	7	6	5	4	3	2	1	0																																							

File	Group	No.	Display Name Full Name Description	Values	Read-Write	Data Type
FEEDBACK & I/O	Analog Inputs	256	<b>753 Anlg In Sqrt</b> Analog Input Square Root Enables/disables the square root function for each input.  Options Reserved Reserved Reserved Reserved Reserved Reserved Reserved Reserved Reserved Reserved Reserved Reserved Reserved Reserved Reserved Analog 0 Default 0 0 0 0 0 0 0 0 0 0 0 0 0 0 0 0 Bit 15 14 13 12 11 10 9 8 7 6 5 4 3 2 1 0	0 = Square Root Disabled 1 = Square Root Enabled	RO	16-bit Integer
		257	<b>753 Anlg In Loss Sts</b> Analog Input Loss Status Status of the analog input loss.  Options Reserved Reserved Reserved Reserved Reserved Reserved Reserved Reserved Reserved Reserved Reserved Reserved Reserved Reserved Loss 0 Reserved Default 0 0 0 0 0 0 0 0 0 0 0 0 0 0 0 0 Bit 15 14 13 12 11 10 9 8 7 6 5 4 3 2 1 0	0 = Loss not Present 1 = Loss Present	RO	16-bit Integer
		260	<b>753 Anlg In0 Value</b> Analog Input 0 Value Value of the Analog input after filter, square root, and loss action.	Units: Volt mA Default: 0.000 Volts 0.000 mA Min/Max: -/+10.000 Volts 0.000 / 20.000 mA	RO	Real
		261	<b>753 Anlg In0 Hi</b> Analog Input 0 High Sets the highest input value to the analog input scaling block.	Units: Volt mA Default: 10.000 Volts 20.000 mA Min/Max: -/+10.000 Volts 0.000 / 20.000 mA	RW	Real
		262	<b>753 Anlg In0 Lo</b> Analog Input 0 Low Sets the lowest input value to the analog input scaling block.	Units: Volts mA Default: 0.000 Volts 0.000 mA Min/Max: -/+10.000 Volts 0.000 / 20.000 mA	RW	Real
		263	<b>753 Anlg In0 LssActn</b> Analog Input 0 Loss Action Selects drive action when an analog signal loss is detected. Signal loss is defined as an analog signal less than 1V or 2mA. The signal loss event ends and normal operation resumes when the input signal level is greater than or equal to 1.5V or 3mA. "Ignore" (0) – No action is taken. "Alarm" (1) – Type 1 alarm indicated. "Flt Minor" (2) – Minor fault indicated. If running, drive continues to run. Enable with P950 [Minor Flt Cfg]. If not enabled, acts like a major fault. "FltCoastStop" (3) – Major fault indicated. Coast to Stop. "Flt RampStop" (4) – Major fault indicated. Ramp to Stop. "Flt CL Stop" (5) – Major fault indicated. Current Limit Stop. "Hold Input" (6) – Holds input at last value. "Set Input Lo" (7) – Sets input to P262 [Anlg In0 Lo]. "Set Input Hi" (8) – Sets input to P261 [Anlg In0 Hi].	Default: 0 = "Ignore" Options: 0 = "Ignore" 1 = "Alarm" 2 = "Flt Minor" 3 = "FltCoastStop" 4 = "Flt RampStop" 5 = "Flt CL Stop" 6 = "Hold Input" 7 = "Set Input Lo" 8 = "Set Input Hi"	RW	32-bit Integer



File	Group	No.	Display Name Full Name Description	Values	Read-Write	Data Type
FEEDBACK & I/O	Analog Inputs	264	<b>753 Anlg In0 Raw Val</b> Analog Input 0 Raw Value Raw Value of the analog input.	Units: Volt mA Default: 0.000 Volts 0.000 mA Min/Max: -/+10.000 Volts 0.000 / 20.000 mA	RO	Real
		265	<b>753 Anlg In0 Filt Gn</b> Analog Input 0 Filter Gain Sets the analog input filter gain. The default setting represents no filtering.	Default: 1.00 Min/Max: -/+5.00	RW	Real
		266	<b>753 Anlg In0 Filt BW</b> Analog Input 0 Filter Bandwidth Sets the analog input filter bandwidth. The default setting represents no filtering.	Default: 0.0 Min/Max: 0.0 / 500.0	RW	Real







File	Group	No.	Display Name Full Name Description	Values	Read-Write	Data Type
FEEDBACK & I/O	Analog Outputs	270	<b>753 Anlg Out Type</b> Analog Output Type Select the analog output mode for each analog output. Options Reserved Reserved Reserved Reserved Reserved Reserved Reserved Reserved Reserved Reserved Reserved Reserved Reserved Reserved Reserved Analog Out 0 Default 0 0 0 0 0 0 0 0 0 0 0 0 0 0 0 0 Bit 15 14 13 12 11 10 9 8 7 6 5 4 3 2 1 0 0 = Voltage Mode 1 = Current Mode		RW	16-bit Integer
		271	<b>753 Anlg Out Abs</b> Analog Output Absolute Selects whether the signed value or absolute value of a parameter is used before being scaled to drive the analog output. Options Reserved Reserved Reserved Reserved Reserved Reserved Reserved Reserved Reserved Reserved Reserved Reserved Reserved Reserved Reserved Analog Out 0 Default 0 0 0 0 0 0 0 0 0 0 0 0 0 0 0 0 Bit 15 14 13 12 11 10 9 8 7 6 5 4 3 2 1 0 0 = Signed 1 = Absolute		RW	16-bit Integer
		275	<b>753 Anlg Out0 Sel</b> Analog Output 0 Select Selects the source for the analog output.	Default: 3 Min/Max: 0 / 159999	RW	32-bit Integer
		276	<b>753 Anlg Out0 Stpt</b> Analog Output 0 Setpoint A possible source for an analog output. Can be used to control an analog output from a communication device using a DataLink. Not affected by analog output scaling.	Units: Volt mA Default: 0.000 Volts 0.000 mA Min/Max: -10/20 Volts 0.000 / 20.000 mA	RW	Real
		277	<b>753 Anlg Out0 Data</b> Analog Output 0 Data Displays the value of the source selected by P275 [Anlg Out0 Sel].	Default: 0 Min/Max: -/+100000	RO	Real
		278	<b>753 Anlg Out0 DataHi</b> Analog Output 0 Data High Sets the high value for the data range of analog out scale.	Units: pu Default: 1.00 Min/Max: -/+214748000.00	RW	Real

File	Group	No.	Display Name Full Name Description	Values		Read-Write	Data Type
FEEDBACK & I/O	Analog Outputs	279	<b>753 Anlg Out0 DataLo</b> Analog Output 0 Data Low Sets the low value for the data range of analog out scale.	Default:	0.00	RW	Real
				Min/Max:	-/+214748000.00		
		280	<b>753 Anlg Out0 Hi</b> Analog Output 0 High Sets the high value for the analog output value when the data value is at its maximum.	Units:	Volt mA	RW	Real
				Default:	10.000 Volts 20.000 mA		
				Min/Max:	-/+10.000 Volts 0.000 / 20.000 mA		
		281	<b>753 Anlg Out0 Lo</b> Analog Output 0 Low Sets the low value for the analog output value when the data value is at its minimum.	Units:	Volt mA	RW	Real
				Default:	0.000 Volts 0.000 mA		
				Min/Max:	-/+10.000 Volts 0.000 / 20.000 mA		
		282	<b>753 Anlg Out0 Val</b> Analog Output 0 Value Displays the analog output value.	Units:	Volt mA	RO	Real
				Default:	10.000 Volts 20.000 mA		
				Min/Max:	-/+10.000 Volts 0.000 / 20.000 mA		

File	Group	No.	Display Name Full Name Description	Values	Read-Write	Data Type																																																			
FEEDBACK & I/O	RO Predict Main	285	<b>753 RO PredMaint Sts</b> Relay Output Predictive Maintenance Status Status of relay 0 predictive maintenance. When the condition of the bit = 1, the predicted relay life has elapsed.  Options <table border="1" style="display: inline-table; vertical-align: top;"> <tr> <td></td> <td>Master</td> <td>Reserved</td> <td>Reserved</td> <td>Reserved</td> <td>Reserved</td> <td>Reserved</td> <td>Reserved</td> <td>Reserved</td> <td>Reserved</td> <td>Reserved</td> <td>Reserved</td> <td>Reserved</td> <td>Reserved</td> <td>Reserved</td> <td>Reserved</td> <td>Relay Out 0</td> </tr> <tr> <td>Default</td> <td>0</td> <td>0</td> <td>0</td> <td>0</td> <td>0</td> <td>0</td> <td>0</td> <td>0</td> <td>0</td> <td>0</td> <td>0</td> <td>0</td> <td>0</td> <td>0</td> <td>0</td> <td>0</td> </tr> <tr> <td>Bit</td> <td>15</td> <td>14</td> <td>13</td> <td>12</td> <td>11</td> <td>10</td> <td>9</td> <td>8</td> <td>7</td> <td>6</td> <td>5</td> <td>4</td> <td>3</td> <td>2</td> <td>1</td> <td>0</td> </tr> </table>		Master	Reserved	Reserved	Reserved	Reserved	Reserved	Reserved	Reserved	Reserved	Reserved	Reserved	Reserved	Reserved	Reserved	Reserved	Relay Out 0	Default	0	0	0	0	0	0	0	0	0	0	0	0	0	0	0	0	Bit	15	14	13	12	11	10	9	8	7	6	5	4	3	2	1	0	0 = Condition False 1 = Condition True	RO	16-bit Integer
			Master	Reserved	Reserved	Reserved	Reserved	Reserved	Reserved	Reserved	Reserved	Reserved	Reserved	Reserved	Reserved	Reserved	Reserved	Relay Out 0																																							
		Default	0	0	0	0	0	0	0	0	0	0	0	0	0	0	0	0																																							
		Bit	15	14	13	12	11	10	9	8	7	6	5	4	3	2	1	0																																							
		286	<b>753 R00 Load Type</b> Relay Output 0 Load Type Sets the type of load that will be applied to the relay. Must be properly set for the Predictive Maintenance function to predict the relay life.	Default: 1 = "DC Inductive" Options: 0 = "DC Resistive" 1 = "DC Inductive" 2 = "AC Resistive" 3 = "AC Inductive"	RW	32-bit Integer																																																			
		287	<b>753 R00 Load Amps</b> Relay Output 0 Load Amps Load current that will be applied to the relay contacts. Must be properly set for the Predictive Maintenance function to approximate the relay life.	Units: Amps Default: 2.000 Min/Max: 0.000 / 2.000	RW	Real																																																			
		288	<b>753 R00 TotalLife</b> Relay Output 0 Total Life Total life cycles of the relay based on programmed load type and amps.	Units: Cycl Default: 0 Min/Max: 0 / 2147483647	RO	32-bit Integer																																																			
		289	<b>753 R00 ElapsedLife</b> Relay Output 0 Elapsed Life Non-resettable, total accumulated cycles of the relay.	Units: Cycl Default: 0 Min/Max: 0 / 2147483647	RO	32-bit Integer																																																			
290	<b>753 R00 RemainLife</b> Relay Output 0 Remaining Life The difference between the Total Life and the Elapsed Life.	Units: Cycl Default: 0 Min/Max: -/+2147483647	RO	32-bit Integer																																																					
291	<b>753 R00 LifeEvtLvl</b> Relay Output 0 Life Event Level Sets the percentage of relay life cycles before action is taken.	Units: % Default: 80.000 Min/Max: 0.000 / 100.000	RW	Real																																																					
292	<b>753 R00 LifeEvtActn</b> Relay Output 0 Life Event Action Sets the action that will be taken when the percentage of relay life cycles has been reached. "Ignore" (0) – No action is taken. "Alarm" (1) – Type 1 alarm indicated. "Flt Minor" (2) – Minor fault indicated. If running, drive continues to run. Enable with P950 [Minor Flt Cfg]. If not enabled, acts like a major fault. "FltCoastStop" (3) – Major fault indicated. Coast to Stop. "Flt RampStop" (4) – Major fault indicated. Ramp to Stop. "Flt CL Stop" (5) – Major fault indicated. Current Limit Stop.	Default: 1 = "Alarm" Options: 0 = "Ignore" 1 = "Alarm" 2 = "Flt Minor" 3 = "FltCoastStop" 4 = "Flt RampStop" 5 = "Flt CL Stop"	RW	32-bit Integer																																																					

## Drive (Port 0) Cfg File







File	Group	No.	Display Name Full Name Description	Values		Read-Write	Data Type
				Default:	Options:		
DRIVE CFG	Preferences	300	<b>Speed Units</b>  Speed Units Selects the units to be used for all speed related parameters. This parameter is only reset when Set Defaults "All" (not recommended) is executed.	Default:	Current Selection	RW	32-bit Integer
				Options:	0 = "Hz" 1 = "RPM"		
		301	<b>Access Level</b>  Access Level Sets the access level for parameters and option choices. "Basic" (0) – Provides the smallest, simplest, and most user friendly view. "Advanced" (1) – May be required to use advanced features. "Expert" (2) – Not normally recommended (makes the list very long), and shows extra parameters that should rarely be required. When the access level is changed, PC-based tools (for example Drive Tools and Drive Explorer) will require a reconnect. This parameter is only reset when Set Defaults "All" (not recommended) is executed.	Default:	Current Selection	RW	32-bit Integer
		Options:	0 = "Basic" 1 = "Advanced" 2 = "Expert"				
		302	<b>Language</b> Language Select display language. This parameter is only reset when Set Defaults "All" (not recommended) is executed.	Default:	0 = "Not Selected"	RW	32-bit Integer
				Options:	0 = "Not Selected" 1 = "English" 2 = "French" 3 = "Spanish" 4 = "Italian" 5 = "German" 6 = "Japanese" 7 = "Portuguese" 8 = "Chinese" 9 = "Reserved" 10 = "Reserved" 11 = "Korean"		

File	Group	No.	Display Name Full Name Description	Values	Read-Write	Data Type								
DRIVE CFG	Control Cfg	305	<b>Voltage Class</b>  Voltage Class  Selects the voltage class operation of the drive. For 400 / 480V drives “Low Voltage” = 400V and “High Voltage” = 480V. This setting affects how the drive will appear as a node on a system (400V or 480V), and also affects the drive’s current rating, parameter 21 [Rated Amps]. If the setting of this parameter is changed, check the setting of P422 [Current Limit 1] and 423 [Current Limit 2]. This parameter is only reset (to original factory setting) when Set Defaults “All” (not recommended) is executed.	Default: 0 = Based on Factory Setting Options: 0 = “Low Voltage” 1 = “High Voltage”	RW	32-bit Integer								
		306	<b>Duty Rating</b>  Duty Rating  Selects the continuous and overload capacity of the drive. “Normal Duty” (0) – Provides the highest continuous rating, but smaller overload ratings (110% for 60 seconds, 150% for 3 seconds). “Heavy Duty” (1) – Provides a smaller continuous rating, but larger overload ratings (150% for 60 seconds, 180% for 3 seconds). “Light Duty” (2) – Only used by Frame 8 drives and larger, provides an overload rating of 110% for 60 seconds. If the setting of this parameter is changed, check the setting of P422 [Current Limit 1] and 423 [Current Limit 2]. This parameter is only reset when Set Defaults “All” (not recommended) is executed. For Frame 2 drives rated under 7.5 kW (10 Hp) this parameter only displays the normal duty rating but will have heavy duty overload ratings. Changing the setting of this parameter will limit the motor current rating so the drive can supply this overload for the motor.	Default: 0 = “Normal Duty” Options: 0 = “Normal Duty” 1 = “Heavy Duty” 2 = “Light Duty” <sup>755 (8+)</sup>	RW	32-bit Integer								
		308	<b>Direction Mode</b>  Direction Mode Selects method for changing direction.	Default: 0 = “Unipolar” Options: 0 = “Unipolar” 1 = “Bipolar” 2 = “Rev Disable”	RW	32-bit Integer								
			<table border="1"> <thead> <tr> <th>Mode</th> <th>Direction Change</th> </tr> </thead> <tbody> <tr> <td>Unipolar</td> <td>Drive Logic (Forward/Reverse bit.)</td> </tr> <tr> <td>Bipolar</td> <td>Sign of Reference</td> </tr> <tr> <td>Rev Disable</td> <td>Not Changeable</td> </tr> </tbody> </table>	Mode	Direction Change	Unipolar	Drive Logic (Forward/Reverse bit.)	Bipolar	Sign of Reference	Rev Disable	Not Changeable			
Mode	Direction Change													
Unipolar	Drive Logic (Forward/Reverse bit.)													
Bipolar	Sign of Reference													
Rev Disable	Not Changeable													
			 <b>ATTENTION:</b> Enabling the Bipolar Direction Mode can cause unexpected direction changes. Equipment damage and/or personal injury can result if this parameter is used in an inappropriate application. Do Not use this function without considering all applicable local, national, and international codes standards, regulations, or industry guidelines.											

File	Group	No.	Display Name Full Name Description	Values	Read-Write	Data Type
DRIVE CFG	Control Cfg	309	<b>SpdTrqPsn Mode A</b>	Default: 1 = "Speed Reg" Options: 0 = "Zero Torque" 1 = "Speed Reg" <sup>(1)</sup> 2 = "Torque Reg" 3 = "SLAT Min" 4 = "SLAT Max" 5 = "Sum" 6 = "Profiler" <sup>755</sup> 7 = "Psn PTP" 8 = "Psn Camming" <sup>755</sup> 9 = "Psn PLL" <sup>755</sup> 10 = "Psn Direct" 11 = "Psn SpdOrnt" <sup>755</sup>  (1) All options, except "Speed Reg," require the drive to be set to a Flux Vector motor control mode. See P35 [Motor Ctrl Mode].	RW	32-bit Integer
		310	<b>SpdTrqPsn Mode B</b>			
		311	<b>SpdTrqPsn Mode C</b>			
		312	<b>SpdTrqPsn Mode D</b>			
			Speed Torque Position Mode A, B, C, D Applies only to the Flux Vector control modes in P35 [Motor Ctrl Mode], options 3 "Induction FV," 6 "PM FV," and 10 "IPM FV." It selects between speed regulation, torque regulation, or position regulation operation of the drive. The source of P685 [Selected Trq Ref] will be determined by the selection in this parameter when P181 [DI SpTqPs Sel 0] and P182 [DI SpTqPs Sel 1] have selected "Disabled" or selected bits that are logic low. In P935 [Drive Status 1] three bits are provided that indicate the regulation mode of the drive when it is running. Bit 21 "Speed Mode" will become set when the drive is running with the speed regulator active. Similarly, Bit 22 "PositionMode" and Bit 23 "Torque Mode" indicate when their respective regulation modes are active. Under some conditions, the active torque mode may be forced into speed mode regardless of the setting of Speed/Torque/Position. The P313 [Actv SpTqPs Mode] parameter will indicate this and will reflect the mode selection that is in use. Possible selections for Speed/Torque/Position are: "Zero Torque" (0) – Drive operates as a torque regulator with P685 [Selected Trq Ref] forced to a constant value of zero torque. "Speed Reg" (1) – Drive operates as a speed regulator. P685 [Selected Trq Ref] comes from P660 [SReg Output] plus P699 [Inertia Comp Out]. "Torq Reg" (2) – Drive operates as a torque regulator. P685 [Selected Trq Ref] comes from P4 [Commanded Trq]. Under some conditions such as jogging or performing a ramp to stop operation, the drive will automatically bypass this selection and temporarily switch to speed regulation mode. "SLAT Min" (3) – Drive operates in "Speed Limited Adjustable Torque – Minimum select" mode. This is a special mode of operation used primarily in web handling applications. The drive will typically operate as a torque regulator, provided that the P4 [Commanded Trq] value is algebraically smaller in value than the speed regulator's output. The drive may automatically enter speed regulation mode, based on conditions within the speed regulator and the magnitude of the speed regulator's output relative to the torque reference. "SLAT Max" (4) – Drive operates in "Speed Limited Adjustable Torque – Maximum select" mode. This is a special mode of operation used primarily in web handling applications. The drive will typically operate as a torque regulator, provided that the P4 [Commanded Trq] value is algebraically larger in value than the speed regulator's output. The drive may automatically enter speed regulation mode, based on conditions within the speed regulator and the magnitude of the speed regulator's output relative to the torque reference. "Sum" (5) – Drive operates as a speed regulator. P685 [Selected Trq Ref] comes from P660 [SReg Output] plus torque adders summed with P4 [Commanded Trq]. "Profiler" (6) – Drive uses the Speed Profiler / Position Indexer function. The drive operates as either a speed or position regulator. Mode of operation will depend on the configuration of the Step Types in the Profiler / Indexer table. See <a href="#">page 429</a> . "Psn PTP" (7) – Drive operates as a position regulator. P685 [Selected Trq Ref] has the same source as in Sum mode. The position control is active in Point-to-Point mode and uses its Point-to-point position reference. To jog in the Position mode, set P635 [Spd Options Ctrl] Bit 6. "Psn Camming" (8) – Drive operates as a position regulator. P685 [Selected Trq Ref] has the same source as in Sum mode. The position control is active in Position CAM mode and uses its PCAM Planner position and speed reference. "Psn PLL" (9) – Drive operates as a position regulator. P685 [Selected Trq Ref] has the same source as in Sum mode. The position control is active in Position Phase Lock Loop mode and uses its PLL Planner position and speed reference. "Psn Direct" (10) – Drive operates as a position regulator. P685 [Selected Trq Ref] has the same source as in Sum mode. The position control is active in Direct mode and uses its Direct Position Reference. "Psn SpdOrnt" (11) – Drive operates in the positioning mode to position the load side of a machine to P1582 [S0 Setpoint]			






File	Group	No.	Display Name Full Name Description	Values	Read-Write	Data Type
DRIVE CFG	Control Cfg	313	<b>Actv SpTqPs Mode</b> Active Speed Torque Position Mode Displays the Speed, Torque, Position Mode that is active, based on the dynamic selection of modes A, B, C, and D, per P309 . . . P312, and digital input conditions programmed via P181 and P182. In some cases, such as operation in the SLAT min/max modes, the final regulation mode may be forced into Speed Regulation. Refer to the Speed, Torque, and Position mode bits in P935 [Drive Status 1] that indicate the final regulation mode of the drive when it is running.	Default: 1 = "Speed Reg" Options: 0 = "Zero Torque" 1 = "Speed Reg" 2 = "Torque Reg" 3 = "SLAT Min" 4 = "SLAT Max" 5 = "Sum" 6 = "Profiler" <span style="background-color: #cccccc;">755</span> 7 = "Psn PTP" 8 = "Psn Camming" <span style="background-color: #cccccc;">755</span> 9 = "Psn PLL" <span style="background-color: #cccccc;">755</span> 10 = "Psn Direct" 11 = "Psn SpdlOrnt" <span style="background-color: #cccccc;">755</span>	RO	32-bit Integer
		314	<b>SLAT Err Stpt</b> Speed Limited Adjustable Torque, Error Setpoint Sets the magnitude of P641 [Speed Error] at which the SLAT function will release its Forced Speed Mode signal. This condition must exist for the time specified by P315 [SLAT Dwell Time]. Once released, the drive can operate as a torque regulator, depending on the relative levels of P660 [SReg Output] and P4 [Commanded Trq]. This parameter will be entered in units of Hz or RPM, depending on the value of P300 [Speed Units].	Units: Hz RPM Default: 0.00 Min/Max: 0.00 / P27 [Motor NP Hertz] 0.00 / P28 [Motor NP RPM]	RW	Real
		315	<b>SLAT Dwell Time</b> Speed Limited Adjustable Torque, Dwell Time Sets the time period that P641 [Speed Error] must exceed the P314 [SLAT Err Stpt] magnitude in order to return to min/max torque mode.	Units: Secs Default: 0.00 Min/Max: 0.00 / 2.00	RW	Real
		321	<b>Prchrg Control</b> Precharge Control When disabled, the drive will stay in the precharge mode and will not be able to run. When enabled, the normal precharge operation is run. This parameter allows programmable control of the completion of the precharge function and may be used to coordinate the precharge of a system of drives or to reset P12 [DC Bus Memory] in the drive.	Default: 1 = "Enabled" Options: 0 = "Disabled" 1 = "Enabled"	RW	32-bit Integer
		322	<b>Prchrg Delay</b> Precharge Delay Adjustable delay between the time all other precharge conditions have been met and the time the drive leaves the precharge state. This can be used to control the sequences of precharge completion in a drive system.	Units: Secs Default: 0.50 Min/Max: 0.10 / 30.00	RW	Real
		323	<b>Prchrg Err Cfg</b> Precharge Error Configuration Selects the action to take when P190 [DI Prchrg Seal] is used to indicate that an external precharge circuit has opened.	Default: 3 = "FltCoastStop" Options: 3 = "FltCoastStop" 4 = "Flt RampStop" 5 = "Flt CL Stop"	RW	32-bit Integer



File	Group	No.	Display Name Full Name Description	Values	Read-Write	Data Type																																																			
DRIVE CFG	Auto Manual Ctrl	324	<b>Logic Mask</b>  Logic Mask Enables/disables ports to control the logic command (such as start and direction). Does not mask Stop commands.	Options <table border="1"> <thead> <tr> <th></th> <th>Reserved</th> <th>Port 14</th> <th>Port 13</th> <th>Reserved</th> <th>Port 11 (1)</th> <th>Port 10 (1)</th> <th>Port 9</th> <th>Port 8</th> <th>Port 7</th> <th>Port 6</th> <th>Port 5</th> <th>Port 4</th> <th>Port 3</th> <th>Port 2</th> <th>Port 1</th> <th>Digital In</th> </tr> </thead> <tbody> <tr> <td>Default</td> <td>0</td> <td>1</td> <td>1</td> <td>0</td> <td>1</td> <td>1</td> <td>1</td> <td>1</td> <td>1</td> <td>1</td> <td>1</td> <td>1</td> <td>1</td> <td>1</td> <td>1</td> <td>1</td> </tr> <tr> <td>Bit</td> <td>15</td> <td>14</td> <td>13</td> <td>12</td> <td>11</td> <td>10</td> <td>9</td> <td>8</td> <td>7</td> <td>6</td> <td>5</td> <td>4</td> <td>3</td> <td>2</td> <td>1</td> <td>0</td> </tr> </tbody> </table> 0 = Disabled 1 = Enabled		Reserved	Port 14	Port 13	Reserved	Port 11 (1)	Port 10 (1)	Port 9	Port 8	Port 7	Port 6	Port 5	Port 4	Port 3	Port 2	Port 1	Digital In	Default	0	1	1	0	1	1	1	1	1	1	1	1	1	1	1	1	Bit	15	14	13	12	11	10	9	8	7	6	5	4	3	2	1	0	RW	16-bit Integer
			Reserved	Port 14	Port 13	Reserved	Port 11 (1)	Port 10 (1)	Port 9	Port 8	Port 7	Port 6	Port 5	Port 4	Port 3	Port 2	Port 1	Digital In																																							
		Default	0	1	1	0	1	1	1	1	1	1	1	1	1	1	1	1																																							
		Bit	15	14	13	12	11	10	9	8	7	6	5	4	3	2	1	0																																							
		325	<b>Auto Mask</b>  Automatic Mask Enables/disables ports to control the logic command (such as start and direction), while in Auto mode. Does not mask Stop commands.	Options <table border="1"> <thead> <tr> <th></th> <th>Reserved</th> <th>Port 14</th> <th>Port 13 (1)</th> <th>Reserved</th> <th>Reserved</th> <th>Reserved</th> <th>Reserved</th> <th>Reserved</th> <th>Reserved</th> <th>Port 6</th> <th>Port 5</th> <th>Port 4</th> <th>Port 3</th> <th>Port 2</th> <th>Port 1</th> <th>Digital In</th> </tr> </thead> <tbody> <tr> <td>Default</td> <td>0</td> <td>1</td> <td>1</td> <td>0</td> <td>0</td> <td>0</td> <td>0</td> <td>0</td> <td>0</td> <td>1</td> <td>1</td> <td>1</td> <td>1</td> <td>1</td> <td>1</td> <td>1</td> </tr> <tr> <td>Bit</td> <td>15</td> <td>14</td> <td>13</td> <td>12</td> <td>11</td> <td>10</td> <td>9</td> <td>8</td> <td>7</td> <td>6</td> <td>5</td> <td>4</td> <td>3</td> <td>2</td> <td>1</td> <td>0</td> </tr> </tbody> </table> 0 = Disabled 1 = Enabled		Reserved	Port 14	Port 13 (1)	Reserved	Reserved	Reserved	Reserved	Reserved	Reserved	Port 6	Port 5	Port 4	Port 3	Port 2	Port 1	Digital In	Default	0	1	1	0	0	0	0	0	0	1	1	1	1	1	1	1	Bit	15	14	13	12	11	10	9	8	7	6	5	4	3	2	1	0	RW	16-bit Integer
	Reserved	Port 14	Port 13 (1)	Reserved	Reserved	Reserved	Reserved	Reserved	Reserved	Port 6	Port 5	Port 4	Port 3	Port 2	Port 1	Digital In																																									
Default	0	1	1	0	0	0	0	0	0	1	1	1	1	1	1	1																																									
Bit	15	14	13	12	11	10	9	8	7	6	5	4	3	2	1	0																																									
326	<b>Manual Cmd Mask</b>  Manual Command Mask Relinquishes exclusive control and allows other ports to begin jogging or to change direction while the port is in the Manual mode.	Options <table border="1"> <thead> <tr> <th></th> <th>Reserved</th> <th>Port 14</th> <th>Port 13 (1)</th> <th>Reserved</th> <th>Reserved</th> <th>Reserved</th> <th>Reserved</th> <th>Reserved</th> <th>Reserved</th> <th>Port 6</th> <th>Port 5</th> <th>Port 4</th> <th>Port 3</th> <th>Port 2</th> <th>Port 1</th> <th>Digital In</th> </tr> </thead> <tbody> <tr> <td>Default</td> <td>0</td> <td>1</td> <td>1</td> <td>0</td> <td>0</td> <td>0</td> <td>0</td> <td>0</td> <td>0</td> <td>1</td> <td>1</td> <td>1</td> <td>1</td> <td>1</td> <td>1</td> <td>1</td> </tr> <tr> <td>Bit</td> <td>15</td> <td>14</td> <td>13</td> <td>12</td> <td>11</td> <td>10</td> <td>9</td> <td>8</td> <td>7</td> <td>6</td> <td>5</td> <td>4</td> <td>3</td> <td>2</td> <td>1</td> <td>0</td> </tr> </tbody> </table> 0 = Disabled 1 = Enabled		Reserved	Port 14	Port 13 (1)	Reserved	Reserved	Reserved	Reserved	Reserved	Reserved	Port 6	Port 5	Port 4	Port 3	Port 2	Port 1	Digital In	Default	0	1	1	0	0	0	0	0	0	1	1	1	1	1	1	1	Bit	15	14	13	12	11	10	9	8	7	6	5	4	3	2	1	0	RW	16-bit Integer		
	Reserved	Port 14	Port 13 (1)	Reserved	Reserved	Reserved	Reserved	Reserved	Reserved	Port 6	Port 5	Port 4	Port 3	Port 2	Port 1	Digital In																																									
Default	0	1	1	0	0	0	0	0	0	1	1	1	1	1	1	1																																									
Bit	15	14	13	12	11	10	9	8	7	6	5	4	3	2	1	0																																									
327	<b>Manual Ref Mask</b>  Manual Reference Mask Enables/disables ports to control the speed reference while in Manual Mode. When a port is commanding manual mode, the reference is forced to the commanding port if the respective bit in this parameter is set. If an alternate speed reference source is desired, use P328 [Alt Man Ref Sel] to select the source.	Options <table border="1"> <thead> <tr> <th></th> <th>Reserved</th> <th>Port 14</th> <th>Port 13</th> <th>Reserved</th> <th>Reserved</th> <th>Reserved</th> <th>Reserved</th> <th>Reserved</th> <th>Reserved</th> <th>Port 6</th> <th>Port 5</th> <th>Port 4</th> <th>Port 3</th> <th>Port 2</th> <th>Port 1</th> <th>Digital In</th> </tr> </thead> <tbody> <tr> <td>Default</td> <td>0</td> <td>0</td> <td>0</td> <td>0</td> <td>0</td> <td>0</td> <td>0</td> <td>0</td> <td>0</td> <td>0</td> <td>0</td> <td>0</td> <td>1</td> <td>1</td> <td>1</td> <td>1</td> </tr> <tr> <td>Bit</td> <td>15</td> <td>14</td> <td>13</td> <td>12</td> <td>11</td> <td>10</td> <td>9</td> <td>8</td> <td>7</td> <td>6</td> <td>5</td> <td>4</td> <td>3</td> <td>2</td> <td>1</td> <td>0</td> </tr> </tbody> </table> 0 = Disabled 1 = Enabled		Reserved	Port 14	Port 13	Reserved	Reserved	Reserved	Reserved	Reserved	Reserved	Port 6	Port 5	Port 4	Port 3	Port 2	Port 1	Digital In	Default	0	0	0	0	0	0	0	0	0	0	0	0	1	1	1	1	Bit	15	14	13	12	11	10	9	8	7	6	5	4	3	2	1	0	RW	16-bit Integer		
	Reserved	Port 14	Port 13	Reserved	Reserved	Reserved	Reserved	Reserved	Reserved	Port 6	Port 5	Port 4	Port 3	Port 2	Port 1	Digital In																																									
Default	0	0	0	0	0	0	0	0	0	0	0	0	1	1	1	1																																									
Bit	15	14	13	12	11	10	9	8	7	6	5	4	3	2	1	0																																									
328	<b>Alt Man Ref Sel</b>   Alternate Manual Reference Select Provides a way to select a speed reference source when in manual mode, that is different than the port which is actuating the manual request. Specifies the port to be used for the reference. The default setting (0) results in the actuating port being the one that is used for the manual reference.	Default: 0 Min/Max: 0 / 159999	RW	32-bit Integer																																																					

File	Group	No.	Display Name Full Name Description	Values	Read-Write	Data Type
DRIVE CFG	Auto Manual Ctr	329	<b>Alt Man Ref AnHi</b> Alternate Manual Reference Analog High Hi scale for the alternate manual speed reference when P328 [Alt Man Ref Sel] is connected to an Analog Input.	Units: Hz RPM Default: P520 Min/Max: P521 / P520	RW	Real
		330	<b>Alt Man Ref AnLo</b> Alternate Manual Reference Analog Low Lo scale for the alternate manual speed reference when P328 [Alt Man Ref Sel] is connected to an Analog Input.	Units: Hz RPM Default: 0 Min/Max: P521 / P520	RW	Real
		331	<b>Manual Preload</b> Manual Preload Enables/disables automatic preloading of the “Auto” speed reference into a HIM when the HIM has been granted Manual control while in Auto mode. See P935 [Drive Status 1] Bit 9 “Manual” to verify the operating condition of the drive. <b>Important:</b> Preload will only occur if the transfer from auto to manual is done while the drive is running.	Options Reserved Reserved Reserved Reserved Reserved Reserved Reserved Reserved Reserved Reserved Reserved Reserved Port 3 Port 2 Port 1 Reserved Default 0 0 0 0 0 0 0 0 0 0 0 0 0 0 0 0 0 0 Bit 15 14 13 12 11 10 9 8 7 6 5 4 3 2 1 0 0 = Disabled 1 = Enabled	RW	16-bit Integer

File	Group	No.	Display Name Full Name Description	Values	Read-Write	Data Type
DRIVE CFG	Drive Memory	336	<b>Reset Meters</b> Reset Meters Resets selected meters to zero. The value will automatically be returned to 0. “MWH and kWh” (1) – Resets P13 [Elapsed MWH], P14 [Elapsed kWh], P16 [Elpsd Mtr MWHrs], P17 [Elpsd Rgn MWHrs], P18 [Elpsd Mtr kWhrs], and P19 [Elpsd Rgn kWhrs]. “Elapsed Time” (2) – Resets P15 [Elapsed Run Time].	Default: 0 = “Ready” Options: 0 = “Ready” 1 = “MWH and kWh” 2 = “Elapsed Time”	RW	32-bit Integer

File	Group	No.	Display Name Full Name Description	Values		Read-Write	Data Type
DRIVE CFG	Start Features	338	<b>AutoClrFlt Tries</b> Auto Clear Fault Tries Number of attempts to execute a Clear faults on an auto-clearable fault when the drive is STOPPED. Exceeding this count results in a fault based on bit 1 of [Auto Retry Fault]. A value of '0' disables the function. See <a href="#">Table 10</a> , Drive Fault and Alarm Types, Descriptions, and Actions, for faults that apply.	Units Default Min/Max Active State	None 0 0/9 Running or Idle	RW	32-bit Integer
		339	<b>AutoClrFlt Delay</b> Auto Clear Fault Delay Time delay between when auto-clearable fault occurs and when it is auto-cleared.	Units Default Min/Max Active State	Secs 30.0 0.5/86400.0 (10 days) Running or Idle	RW	Real
		340	<b>AutoClrCntrDelay</b> Auto Clear Control Delay Time delay after an auto clear fault, where if no further auto-clearable faults are detected & this delay expires, the running Retries counter is cleared. A START performs the same action	Units Default Min/Max Active State	Secs 300.0 (5 minutes) 0.1/86400.0 (10 days) Running or Idle	RW	Real
		343	<b>Rstrt Cntr Delay</b> Restart Control Delay Time delay after an Auto Restart, where if no further Auto restarts were performed & this delay expires, the running Retries counter is cleared	Units Default Min/Max Active State	None 300 (5 minutes) 0.1/86400.0 (10 days) Running or Idle	RW	Real


File	Group	No.	Display Name Full Name Description	Values	Read-Write	Data Type																																																						
DRIVE CFG	Start Features	345	<b>Start At PowerUp</b>  Start At Power Up Enables/disables a feature to issue a Run command and automatically resume running at commanded speed after drive input power is restored. Requires a digital input, P163 [DI Run], P164 [DI Run Forward], or P165 [DI Run Reverse], is configured for Run and a valid start contact.	Default: 0 = "Disabled" Options: 0 = "Disabled" 1 = "Enabled"	RW	32-bit Integer																																																						
		 <b>ATTENTION:</b> Equipment damage and/or personal injury may result if this parameter is used in an inappropriate application. Do not use this function without considering applicable local, national and international codes, standards, regulations or industry guidelines.																																																										
		346	<b>PowerUp Delay</b> Power Up Delay Defines the programmed delay time, in seconds, before a start command is accepted after power up.	Units: Secs Default: 0.00 Min/Max: 0.00 / 10800.00	RW	Real																																																						
		347	<b>Auto Retry Fault</b> Automatic Retry Fault When set and the "Auto-Clear faults Retries" have been exhausted, a fault is logged in the Fault queue. If the fault condition remains after the amount of time specified in P348 [Auto Rstrt Tries] elapses, an F33 "AuRsts Exhausted" fault occurs.	Options <table border="1" data-bbox="295 982 906 1157"> <thead> <tr> <th>Options</th> <th>Reserved</th> <th>Reserved</th> <th>Reserved</th> <th>Reserved</th> <th>Reserved</th> <th>Reserved</th> <th>Reserved</th> <th>Reserved</th> <th>Reserved</th> <th>Reserved</th> <th>Reserved</th> <th>Reserved</th> <th>Reserved</th> <th>Reserved</th> <th>Reserved</th> <th>AutClrAttExh</th> <th>AttmpsExhstd</th> </tr> </thead> <tbody> <tr> <td>Default</td> <td>0</td> <td>0</td> <td>0</td> <td>0</td> <td>0</td> <td>0</td> <td>0</td> <td>0</td> <td>0</td> <td>0</td> <td>0</td> <td>0</td> <td>0</td> <td>0</td> <td>0</td> <td>0</td> <td>0</td> </tr> <tr> <td>Bit</td> <td>15</td> <td>14</td> <td>13</td> <td>12</td> <td>11</td> <td>10</td> <td>9</td> <td>8</td> <td>7</td> <td>6</td> <td>5</td> <td>4</td> <td>3</td> <td>2</td> <td>1</td> <td>0</td> <td>0</td> </tr> </tbody> </table> 0 = Condition False 1 = Condition True	Options	Reserved	Reserved	Reserved	Reserved	Reserved	Reserved	Reserved	Reserved	Reserved	Reserved	Reserved	Reserved	Reserved	Reserved	Reserved	AutClrAttExh	AttmpsExhstd	Default	0	0	0	0	0	0	0	0	0	0	0	0	0	0	0	0	0	Bit	15	14	13	12	11	10	9	8	7	6	5	4	3	2	1	0	0	RW	16-bit Integer
		Options	Reserved	Reserved	Reserved	Reserved	Reserved	Reserved	Reserved	Reserved	Reserved	Reserved	Reserved	Reserved	Reserved	Reserved	Reserved	AutClrAttExh	AttmpsExhstd																																									
Default	0	0	0	0	0	0	0	0	0	0	0	0	0	0	0	0	0																																											
Bit	15	14	13	12	11	10	9	8	7	6	5	4	3	2	1	0	0																																											
Bit 0 - "AttmpsExhstd" - Enables the Retries Exhausted Fault action. If the fault condition remains after the amount of time specified in P348 [Auto Rstrt Tries] elapses, an F33 "AutoRstsExhausted" fault occurs. Bit 1 - AutClrAttExh (Auto clr flts) Enables Auto Clear Fault Exhausted fault action. If the fault condition remains after the amount of time specified in P338 [AutoClrFlt Tries] elapses, an F34 'AutClrFltExhaust' fault occurs.																																																												
348	<b>Auto Rstrt Tries</b> Automatic Restart Tries Sets the maximum number of times the drive attempts to reset a fault and restart. See <a href="#">Table 10</a> , Drive Fault and Alarm Types, Descriptions, and Actions, for faults that apply.	Default: 0 (Disabled) Min/Max: 0 / 9	RW	32-bit Integer																																																								
 <b>ATTENTION:</b> Equipment damage and/or personal injury may result if this parameter is used in an inappropriate application. Do not use this function without considering applicable local, national and international codes, standards, regulations or industry guidelines.																																																												
349	<b>Auto Rstrt Delay</b> Automatic Restart Delay Sets the time between restart attempts when 348 [Auto Rstrt Tries] is set to a value other than zero.	Units: Secs Default: 1.00 Min/Max: 0.50 / 30.00	RW	Real																																																								


File	Group	No.	Display Name Full Name Description	Values	Read-Write	Data Type																						
DRIVE CFG	Start Features	350	<b>Sleep Wake Mode</b>  Sleep Wake Mode Enables/disables the Sleep/Wake function. <b>Important:</b> When enabled, the following conditions must be met: <ul style="list-style-type: none"> <li>• A proper value must be programmed for 352 [Sleep Level] and 354 [Wake Level].</li> <li>• A sleep / wake reference must be selected in 351 [SleepWake RefSel].</li> <li>• At least one of the following must be programmed (and input closed) in P155 [DI Enable], P158 [DI Stop], P163 [DI Run], P164 [DI Run Forward], or P165 [DI Run Reverse].</li> </ul>	Default: 0 = "Disabled" Options: 0 = "Disabled" 1 = "Direct" (Enabled) 2 = "Invert" (Enabled) <sup>(7)</sup>	RW	32-bit Integer																						
		<div style="border: 1px solid black; padding: 5px;">  <p><b>ATTENTION:</b> Enabling the Sleep/Wake function can cause unexpected machine operation during the Wake mode. Equipment damage and/or personal injury can result if this parameter is used in an inappropriate application. Do Not use this function without considering the information below. In addition, all applicable local, national, and international codes, standards, regulations, or industry guidelines must be considered.</p> </div>																										
<p><b>Conditions Required to Start Drive</b> <sup>(1) (2) (3)</sup></p> <table border="1"> <thead> <tr> <th rowspan="2">Input</th> <th rowspan="2">After Power-Up</th> <th colspan="2">After a Drive Fault</th> <th rowspan="2">After a Stop Command</th> </tr> <tr> <th>Reset by HIM or Software "Stop"</th> <th>Reset by HIM, Network/Software, or Digital Input "Clear Faults"</th> </tr> </thead> <tbody> <tr> <td>Stop<sup>(4)</sup></td> <td>Stop Closed Wake Signal New Start or Run Cmd.<sup>(5)</sup></td> <td>Stop Closed Wake Signal New Start or Run Cmd.<sup>(5)</sup></td> <td>Stop Closed Wake Signal</td> <td>Stop Closed <u>Direct Mode:</u> SleepWake RefSel Signal &gt; Sleep Level<sup>(7)</sup> <u>Invert Mode:</u> SleepWake RefSel Signal &lt; Sleep Level<sup>(8)</sup> New Start or Run Command<sup>(5)</sup></td> </tr> <tr> <td>Enable</td> <td>Enable Closed Wake Signal</td> <td>Enable Closed Wake Signal New Start or Run Cmd.<sup>(5)</sup></td> <td>Enable Closed Wake Signal</td> <td>Enable Closed <u>Direct Mode:</u> SleepWake RefSel Signal &gt; Sleep Level<sup>(7)</sup> <u>Invert Mode:</u> SleepWake RefSel Signal &lt; Sleep Level<sup>(8)</sup> New Start or Run Command<sup>(5)</sup></td> </tr> <tr> <td>Run Run Fwd Run Rev</td> <td>Run Closed Wake Signal</td> <td>New Run Cmd.<sup>(6)</sup> Wake Signal</td> <td>Run Closed Wake Signal</td> <td>New Run Command <u>Direct Mode:</u> SleepWake RefSel Signal &gt; Sleep Level<sup>(7)</sup> <u>Invert Mode:</u> SleepWake RefSel Signal &lt; Sleep Level<sup>(8)</sup></td> </tr> </tbody> </table>							Input	After Power-Up	After a Drive Fault		After a Stop Command	Reset by HIM or Software "Stop"	Reset by HIM, Network/Software, or Digital Input "Clear Faults"	Stop <sup>(4)</sup>	Stop Closed Wake Signal New Start or Run Cmd. <sup>(5)</sup>	Stop Closed Wake Signal New Start or Run Cmd. <sup>(5)</sup>	Stop Closed Wake Signal	Stop Closed <u>Direct Mode:</u> SleepWake RefSel Signal > Sleep Level <sup>(7)</sup> <u>Invert Mode:</u> SleepWake RefSel Signal < Sleep Level <sup>(8)</sup> New Start or Run Command <sup>(5)</sup>	Enable	Enable Closed Wake Signal	Enable Closed Wake Signal New Start or Run Cmd. <sup>(5)</sup>	Enable Closed Wake Signal	Enable Closed <u>Direct Mode:</u> SleepWake RefSel Signal > Sleep Level <sup>(7)</sup> <u>Invert Mode:</u> SleepWake RefSel Signal < Sleep Level <sup>(8)</sup> New Start or Run Command <sup>(5)</sup>	Run Run Fwd Run Rev	Run Closed Wake Signal	New Run Cmd. <sup>(6)</sup> Wake Signal	Run Closed Wake Signal	New Run Command <u>Direct Mode:</u> SleepWake RefSel Signal > Sleep Level <sup>(7)</sup> <u>Invert Mode:</u> SleepWake RefSel Signal < Sleep Level <sup>(8)</sup>
Input	After Power-Up	After a Drive Fault		After a Stop Command																								
		Reset by HIM or Software "Stop"	Reset by HIM, Network/Software, or Digital Input "Clear Faults"																									
Stop <sup>(4)</sup>	Stop Closed Wake Signal New Start or Run Cmd. <sup>(5)</sup>	Stop Closed Wake Signal New Start or Run Cmd. <sup>(5)</sup>	Stop Closed Wake Signal	Stop Closed <u>Direct Mode:</u> SleepWake RefSel Signal > Sleep Level <sup>(7)</sup> <u>Invert Mode:</u> SleepWake RefSel Signal < Sleep Level <sup>(8)</sup> New Start or Run Command <sup>(5)</sup>																								
Enable	Enable Closed Wake Signal	Enable Closed Wake Signal New Start or Run Cmd. <sup>(5)</sup>	Enable Closed Wake Signal	Enable Closed <u>Direct Mode:</u> SleepWake RefSel Signal > Sleep Level <sup>(7)</sup> <u>Invert Mode:</u> SleepWake RefSel Signal < Sleep Level <sup>(8)</sup> New Start or Run Command <sup>(5)</sup>																								
Run Run Fwd Run Rev	Run Closed Wake Signal	New Run Cmd. <sup>(6)</sup> Wake Signal	Run Closed Wake Signal	New Run Command <u>Direct Mode:</u> SleepWake RefSel Signal > Sleep Level <sup>(7)</sup> <u>Invert Mode:</u> SleepWake RefSel Signal < Sleep Level <sup>(8)</sup>																								
<p>(1) When power is cycled, if all conditions are present after power is restored, restart will occur.                      (2) If all conditions are present when [Sleep-Wake Mode] is "enabled," the drive will start.                      (3) The active speed reference. The Sleep/Wake function and the speed reference may be assigned to the same input.                      (4) Cannot use P159 [DI Cur Lmt Stop] or P160 [DI Coast Stop] as the only Stop Input. This will cause the drive to go into a Sleep Cfg Alarm - Event No. 161.                      (5) Command must be issued from HIM, terminal block, or network.                      (6) Run Command must be cycled.                      (7) SleepWake RefSel signal does not need to be greater than the wake level.                      (8) SleepWake RefSel signal does not need to be less than the wake level.</p>																												

File	Group	No.	Display Name Full Name Description	Values	Read-Write	Data Type
DRIVE CFG	Start Features	351	<b>SleepWake RefSel</b> Sleep Wake Reference Select Selects the source of the input controlling the Sleep-Wake function.	Default: 0 (Disabled) Min/Max: 0 / 159999	RW	32-bit Integer
		352	<b>Sleep Level</b> Sleep Level Defines the analog input level that will stop the drive.	Units: Volt, P351 = 0 (Disabled) Volt or mA, P351 = not 0 (Port Device Jumper Setting) Default: 5.00 Volt (P351 = 0) 5.00 Volt / 0.00 mA (Port n Device Jumper Setting) Min/Max: 0.00 / 10.00 Volt 0.00 / 20.00 mA	RW	Real
		353	<b>Sleep Time</b> Sleep Time Defines the amount of time at or below 352 [Sleep Level] before a Stop is issued.	Units: Secs Default: 0.00 Min/Max: 0.00 / 64800	RW	Real
		354	<b>Wake Level</b> Wake Level Defines the analog input level that will start the drive.	Units: Volt, P351 = 0 (Disabled) Volt or mA, P351 = not 0 (Port n Device Jumper Setting) Default: 6.00 Volt (P351 = 0) 6.00 Volt / 12.00 mA (Port n Device Jumper Setting) Min/Max: 0.00 / 10.00 Volt 0.00 / 20.00 mA	RW	Real
		355	<b>Wake Time</b> Wake Time Defines the amount of time at or above 354 [Wake Level] before a Start is issued.	Units: Secs Default: 0.00 Min/Max: 0.00 / 64800	RW	Real
		356	<b>FlyingStart Mode</b> Flying Start Mode Enables/disables the function which reconnects to a spinning motor at actual RPM when a start command is issued. Functional in all motor control modes. "Enhanced" (1) – This advanced mode performs the reconnect function quickly. "Sweep" (2) – This frequency sweep mode is used with output sine filters. "Sweep 2" (3) - This frequency sweep mode is used with motor frequencies above 120 Hz.	Default: 0 = "Disabled" Options: 0 = "Disabled" 1 = "Enhanced" 2 = "Sweep" 3 = "Sweep 2"	RW	32-bit Integer
		357	<b>FS Gain</b> Flying Start Gain P356 [FlyingStart Mode] = 1 "Enhanced": Proportional term used in the current regulator which controls the reconnect function. P356 [FlyingStart Mode] = 2 "Sweep": Time required for the speed detection signal to remain at the programmed level (P360). Units of 50 $\mu$ s.	Default: 1200.0 Min/Max: 0.0 / 10000.0	RW	Real
		358	<b>FS Ki</b> Flying Start Intergal Gain P356 [FlyingStart Mode] = 1 "Enhanced": Integral term used in the current regulator which controls the reconnect function. P356 [FlyingStart Mode] = 2 "Sweep": Integral term used in the voltage recovery to the normal V/Hz level.	Default: 60.0 Min/Max: 0.0 / 1000.0	RW	Real
		359	<b>FS Speed Reg Ki</b> Flying Start Speed Regulator Integral Gain P356 [FlyingStart Mode] = 1 "Enhanced": Integral term used in the speed regulator which controls the reconnect function. P356 [FlyingStart Mode] = 2 "Sweep": Time to sweep frequency in one direction. Units of 10 $\mu$ s.	Default: 100.0 Min/Max: 0.0 / 10000.0	RW	Real



File	Group	No.	Display Name Full Name Description	Values		Read-Write	Data Type
				Default:			
DRIVE CFG	Start Features	360	<b>FS Speed Reg Kp</b> Flying Start Speed Regulator Proportional Gain P356 [FlyingStart Mode] = 1 "Enhanced": Proportional term used in the speed regulator which controls the reconnect function. P356 [FlyingStart Mode] = 2 "Sweep": Programmed level for the speed detection signal. The monitored signal needs to drop below this level to indicate motor speed.	Default: 75.0 Min/Max: 0.0 / 10000.0		RW	Real
		361	<b>FS Excitation Ki</b> Flying Start Excitation Integral Gain P356 [FlyingStart Mode] = 1 "Enhanced": Integral term used in the current regulator which controls the excitation function when the need is determined by the reconnect function. P356 [FlyingStart Mode] = 2 "Sweep": Integral term used to control initial output voltage.	Default: 60.0 Min/Max: 0.0 / 32767.0		RW	Real
		362	<b>FS Excitation Kp</b> Flying Start Excitation Proportional Gain P356 [FlyingStart Mode] = 1 "Enhanced": Proportional term used in the current regulator which controls the excitation function when the need is determined by the reconnect function. P356 [FlyingStart Mode] = 2 "Sweep": Proportional term used to control initial output voltage.	Default: 1200.00 Min/Max: 0.0 / 32767.0		RW	Real
		363	<b>FS Reconnect Dly</b> Flying Start Reconnect Delay Delay time used between the issued start command and the start of the reconnect function.	Units: mSec Default: 50.00 Min/Max: 0.10 / 10000.00		RW	Real
		364	<b>FS Msrmnt CurLvl</b> Flying Start Measurement Current Level P356 [FlyingStart Mode] = 1 "Enhanced": Level of the current used during the measurement stage of the reconnect function. P356 [FlyingStart Mode] = 2 "Sweep": Adjustment for the V/Hz end point. Used to change the slope of the V/Hz curve during the frequency sweep. Note: A value of 4096 is equal to drive rated current.	Default: 44.97 Min/Max: 0.00 / 4096.00		RW	Real
		365	<b>FS Brk Lvl</b> Flying Start Break Level Enter the level of DC braking current that the drive can use for the Flying Start function. The Flying Start function will apply DC brake current to the motor when it determines the motor is spinning near zero speed. It can do this to bring the motor to a complete stop before attempting to restart it.	Units: Amps Default: Same as P394 Min/Max: Same as P394		RW	Real
		366	<b>FS Brk Time</b> Flying Start Break Time Enter the amount of time the drive can apply the DC braking current for the Flying Start function. The DC braking will be applied on every start when this time is not zero, even if flying start is not enabled.	Units: Secs Default: 0.00 Min/Max: 0.00 / 1800.00		RW	Real
		367	<b>FS ZSpd Thresh</b> Flying Start Zero Spd Threshold Enter a value to set the threshold the Flying Start function uses for zero speed detection. The Flying Start function uses this for DC braking.	Units: Secs Default: 200.00 Min/Max: 0.00 / 10000.00		RW	Real



File	Group	No.	Display Name Full Name Description	Values	Read-Write	Data Type	
DRIVE Cfg	Braking Features	370	<b>Stop Mode A</b>	Default	RW	32-bit Integer	
		371	<b>Stop Mode B</b> Stop Mode A, B Method of stopping the drive when a stop command is given. Normal Stop command and the RUN input changing from true to false will command a Normal Stop. When using TorqProve, parameter 1100 [Trq Prove Cfg] Bit 0 "TP Enable" = 1, the stop mode must be set to option 1 "Ramp."  "Coast" (0) – Power removed from motor, motor coasts to zero. "Ramp" (1) – Decelerates to zero speed at the decel rate. Power is removed when zero speed is reached. "Ramp to Hold" (2) – Decelerates to zero speed at the decel rate, followed by DC braking until the next start sequence. "DC Brake" (3) – DC braking is immediately applied (does not follow programmed decel ramp). May have to adjust parameter 397 [DC Brake Kp]. "DCBrkAutoOff" (4) – Applies DC braking until zero speed is reached or DC brake time is reached, whichever is shorter. "Current Lmt" (5) – Max torque / current applied until zero speed. "Fast Brake" (6) – High slip braking for maximum braking performance above base speed.	1 = "Ramp" 0 = "Coast" Options: 0 = "Coast" 1 = "Ramp" 2 = "Ramp to Hold" 3 = "DC Brake" 4 = "DCBrkAutoOff" 5 = "Current Lmt" 6 = "Fast Brake"			
		372	<b>Bus Reg Mode A</b>	Default:			
		373	<b>Bus Reg Mode B</b> Bus Regulation Mode A, B Method and sequence of the DC bus regulator voltage. Choices are dynamic brake, frequency adjust or both. Sequence is determined by programming or digital input to the terminal block. Using options 1, 3, or 4, may result in extended decel times. Typically, only P372 [Bus Reg Mode A] is used. P373 [Bus Reg Mode B] is only used when P187 [DI PwrLoss ModeB] is programmed and its corresponding input is high. <u>Dynamic Brake Setup</u> If a dynamic brake resistor is connected to the drive, both of these parameters must be set to either option 2, 3 or 4. When using any of the dynamic braking settings increase P426 [Regen Power Lmt] from its default setting of 50%. A setting of 200% will result in more effective braking.	Options: 1 = "Adjust Freq" 4 = "Both-Frq 1st" 0 = "Disabled" 1 = "Adjust Freq" 2 = "Dyn Brake" 3 = "Both DB 1st" 4 = "Both Frq 1st"			
<div style="border: 1px solid black; padding: 5px;">  <p><b>ATTENTION:</b> The drive does not offer protection for externally mounted brake resistors. A risk of fire exists if external braking resistors are not protected. External resistor packages must be self-protected from over-temperature or the protective circuit shown in <a href="#">Figure 4 on page 372</a> (or equivalent) must be supplied.</p> </div>							
		374	<b>Bus Reg Lvl Cfg</b> Bus Regulation Level Configuration Selects the reference used to determine the bus voltage regulation level for the bus voltage regulator and the reference used for the dynamic brake. "Bus Memory" (0) – References are determined based on P12 [DC Bus Memory]. "BusReg Level" (1) – References are determined based on the voltage set in the bus regulator level parameter P375 [Bus Reg Level]. If coordinated operation of the dynamic brakes of a common bus system is desired, use this selection and set the P375 [Bus Reg Level] to coordinate the brake operation of the common bus drives.	Default: Options:	0 = "Bus Memory" 0 = "Bus Memory" 1 = "BusReg Level"	RW	32-bit Integer
		375	<b>Bus Reg Level</b> Bus Regulation Level Sets the "turn-on" bus voltage level for the bus voltage regulator and the dynamic brake.	Units: Default:  Min/Max:	V DC P20 < 252V DC: 375 P20 = 252...503V DC: 750 P20 = 504...629V DC: 937 P20 > 629V DC: 1076 P20 < 252V DC: 375/389 P20 = 252...503V DC: 750/779 P20 = 504...629V DC: 937/974 P20 > 629V DC: 1076/1118	RW	Real

File	Group	No.	Display Name Full Name Description	Values	Read-Write	Data Type
DRIVE CFG	Braking Features	376	<b>Bus Limit Kp</b> Bus Limit Proportional Gain Not functional when any of the FV motor control modes are selected.	Units: A/V Default: 1170.0 Min/Max: 0.0 / 1000000.0	RW	Real
		377	<b>Bus Limit Kd</b> Bus Limit Derivative Gain Not functional when any of the FV motor control modes are selected.	Units: Secs Default: 152.0 Min/Max: 0.0 / 1000000.0	RW	Real
		378	<b>Bus Limit ACR Ki</b> Bus Limit Active Current Regulator Integral Gain Not functional when any of the FV motor control modes are selected.	Default: 2045.0 Min/Max: 0.0 / 50000.0	RW	Real
		379	<b>Bus Limit ACR Kp</b> Bus Limit Active Current Regulator Proportional Gain Not functional when any of the FV motor control modes are selected.	Units: Hz/A Default: 524.0 Min/Max: 0.0 / 100000.0	RW	Real
		380	<b>Bus Reg Ki</b> Bus Regulator Integral Gain Integral gain for the bus voltage regulator. Sets the responsiveness of the bus voltage regulator.	Default: 100.000 Min/Max: 0.000 / 65535.000	RW	Real
		381	<b>Bus Reg Kp</b> Bus Regulator Proportional Gain Proportional gain for the bus voltage regulator. Sets the responsiveness of the bus voltage regulator.	Default: 10.000 Min/Max: 0.000 / 65535.000	RW	Real
		382	<b>DB Resistor Type</b> Dynamic Brake Resistor Type Selects whether the internal or external DB protection will be used. <b>Important:</b> Only one DB resistor can be connected to Frame 2 drives. If an external dynamic brake is used with a Frame 2 drive, the internal dynamic brake resistor must be disconnected. Connecting both an internal and external resistor is likely to cause drive damage. If a dynamic brake resistor is connected to the drive, P372 [Bus Reg Mode A] and P373 [Bus Reg Mode B] must be set to either option 2, 3, or 4; otherwise the dynamic brake will not turn on.	Default: 0 = "Internal" Options: 0 = "Internal" 1 = "External"	RW	32-bit Integer
		 <p><b>ATTENTION:</b> Equipment damage may result if a drive mounted (internal) resistor is installed and this parameter is set to "External." Thermal protection for the internal resistor will be disabled, resulting in possible device damage.</p> <p><b>ATTENTION:</b> The drive does not offer protection for externally mounted brake resistors. A risk of fire exists if external braking resistors are not protected. External resistor packages must be self-protected from over-temperature or the protective circuit shown in <a href="#">Figure 4 on page 372</a> (or equivalent) must be supplied.</p>				
		383	<b>DB Ext Ohms</b> Dynamic Brake External Ohms Used to calculate the maximum negative torque available from the dynamic brake and is used for the external resistor dynamic brake protection.	Units: Ohms Default: Based on Drive Rating Min/Max: Internal / 10000.00	RW	Real
384	<b>DB Ext Watts</b> Dynamic Brake External Watts Sets the continuous rated power reference for the external dynamic brake resistor. Only valid when an external dynamic brake resistor is selected (P382 [DB Resistor Type] = 1 "External"). The DB continuous watts are used in the dynamic brake thermal protection algorithm. <b>Important:</b> If customer-supplied protection is to be used in place of the drive's calculated resistor thermal protection, set the [DB Ext Watts] to its maximum value.	Units: Watt Default: 100.00 Min/Max: 1.00 / 500000.00	RW	Real		

File	Group	No.	Display Name Full Name Description	Values		Read-Write	Data Type
		385	<p><b>DB ExtPulseWatts</b> Dynamic Brake External Pulse Watts</p> <p>Sets the thermal transient response of the external dynamic brake resistor defined by the maximum allowable power to the dynamic brake resistor for 1 second without exceeding the resistor's element temperature. This parameter is only valid when an external dynamic brake resistor is selected (P382 [DB Resistor Type] = 1 "External"). If this value is not available from the resistor vendor it can be approximated by 1 or 2 below:</p> <ol style="list-style-type: none"> <li>[DB ExtPulseWatts] = 75,000 x weight (lb), where weight is the weight of the resistor wire in pounds (not the weight of the entire resistor).</li> <li>[DB ExtPulseWatts] = Time Constant x Brake Watts, where the Time Constant equals the amount of time to reach 63% of its rated temperature while the maximum power is applied to the resistor and Brake Watts is the maximum continuous power rating of the resistor.</li> </ol> <p>Many external resistor pulse watts settings are provided in the PowerFlex Dynamic Braking Resistor Calculator, publication <a href="#">PFLEX-AT001</a>, or consult the resistor manufacturer for this specification.</p> <p>Note: If the value of this parameter is set equal to the value of P384 [DB Ext Watts], an F5 "Overvoltage" fault can occur.</p> <p><b>Important:</b> If customer supplied protection is to be used in place of the drive's calculated resistor thermal protection, set the [DB ExtPulse Watts] to its maximum value.</p> <p>This information may show up on your resistor in Joules or Watt-seconds. Use that value in this parameter. Contact the resistor manufacturer if that information is not provided.</p>	Units: Default: Min/Max:	Watt 2000.00 1.00 / 100000000.00	RW	Real



File	Group	No.	Display Name Full Name Description	Values	Read-Write	Data Type
DRIVE CFG	Braking Features	388	<b>Flux Braking En</b> Flux Braking Enable Enables/disables flux braking. Functional in all motor control modes. Does not work with permanent magnet motors. Flux braking is enabled during decel.	Default: 0 = "Disabled" Options: 0 = "Disabled" 1 = "Enabled"	RW	32-bit Integer
		389	<b>Flux Braking Lmt</b> Flux Braking Limit Sets the limit on the desired motor voltage during flux braking as a percent of P25 [Motor NP Volts]. Functional in all motor control modes.	Units: % Default: 125.00 Min/Max: 100.00 / 250.00	RW	Real
		390	<b>Flux Braking Ki</b> Flux Braking Integral Gain Flux braking controller integral gain Functional in all motor control modes.	Default: 10000.0 Min/Max: 0.0 / 1000000.0	RW	Real
		391	<b>Flux Braking Kp</b> Flux Braking Proportional Gain Flux braking controller proportional gain. Functional in all motor control modes.	Units: V/A Default: 100.0 Min/Max: 0.0 / 1000000.0	RW	Real
		392	<b>Stop Dwell Time</b> Stop Dwell Time Stop dwell sets an adjustable delay time between detecting zero speed and disabling the speed and torque regulators, when responding to a stop command.	Default: 0 Min/Max: 0 / 60	RW	Real
		393	 <b>DC Brake Lvl Sel</b> DC Brake Level Select Sets link to source used for P394 [DC Brake Level]. Functional in all motor control modes.	Default: 394 Min/Max: 1 / 159999	RW	32-bit Integer
		394	<b>DC Brake Level</b> DC Brake Level Defines the DC brake current level injected into the motor when P370/371 [Stop Mode <i>n</i> ] = 3 "DC Brake." This also sets the braking current level when 6 "Fast Stop" is selected. The DC braking voltage used in this function is created by a PWM algorithm and may not generate the smooth holding force needed for some applications. Functional in all motor control modes.	Units: Amps Default: [Rated Amps] Min/Max: P21 [Rated Amps] x 0.01 / Based on Drive Rating	RW	Real
			 <p><b>ATTENTION:</b> If a hazard of injury due to movement of equipment or material exists, an auxiliary mechanical braking device must be used.</p> <p><b>ATTENTION:</b> This feature should not be used with synchronous or permanent magnet motors. Motors may be demagnetized during braking.</p>			

File	Group	No.	Display Name Full Name Description	Values		Read-Write	Data Type
DRIVE CFG	Braking Features	395	<b>DC Brake Time</b> DC Brake Time Sets the amount of time DC brake current is “injected” into the motor. When the active stop mode, P370/371 [Stop Mode <i>n</i> ] = 2 “Ramp to Hold,” this parameter is ignored and DC braking is applied continuously. Functional in all motor control modes.	Units: Default: Min/Max:	Secs 0.00 0.00 / 90.00	RW	Real
		396	<b>DC Brake Ki</b> DC Brake Integral Gain Sets the integral term used in the current regulator which controls the DC Brake function. Functional in all motor control modes.	Default: Min/Max:	10.0 0.0 / 1000.0	RW	Real
		397	<b>DC Brake Kp</b> DC Brake Proportional Gain Sets the proportional term used in the current regulator which controls the DC Brake function.	Default: Min/Max:	1000.0 0.0 / 10000.0	RW	Real
		398	<b>DC Brk Vq Ftr</b> DC Brake Vq Filter Sets the level of filtering used on the Vq signal when the active stop mode P370/371 [Stop Mode <i>n</i> ] = 4 “DCBrkAutoOff.”	Default: Min/Max:	250.0 50.0 / 2000.0	RW	Real
		399	<b>DC Brk Vd Ftr</b> DC Brake Vd Filter Sets the level of filtering used on the Vd signal when the active stop mode P370/371 [Stop Mode <i>n</i> ] = 4 “DCBrkAutoOff.”	Default: Min/Max:	250.0 50.0 / 2000.0	RW	Real
		400	<b>Fast Braking Ki</b> Fast Braking Integral Gain Sets the integral term used in the speed regulator which controls the Fast Braking function. Functional in all motor control modes.	Default: Min/Max:	0.10 0.00 / 10.00	RW	Real
		401	<b>Fast Braking Kp</b> Fast Braking Proportional Gain Sets the proportional term used in the speed regulator which controls the Fast Braking function. Functional in all motor control modes.	Default: Min/Max:	0.0015 0.0000 / 10.0000	RW	Real
		402	<b>Brake Off Adj 1</b> Brake Off Adjustment 1 When Fast Braking is the selected Stop Mode, this parameter sets the power sensitivity to transition from Fast Braking to DC Brake. When DC Brake w/Auto ShutOff is selected, this parameter sets the level sensitivity for shut off.	Default: Min/Max:	1.00 0.01 / 5.00	RW	Real
		403	<b>Brake Off Adj 2</b> Brake Off Adjustment 2 When Fast Braking is the selected Stop Mode, this parameter sets the frequency sensitivity to transition from Fast Braking to DC Brake. When DC Brake w/Auto ShutOff is selected, this parameter sets the time sensitivity for shut off.	Default: Min/Max:	1.00 0.01 / 5.00	RW	Real
409	<b>Dec Inhibit Actn</b> Deceleration Inhibit Action Configures the response to a Decel Inhibit condition, which occurs when the drive is not decelerating. One possible cause could be bus voltage regulation. “Ignore” (0) – No action is taken. “Alarm” (1) – Type 1 alarm indicated. “Flt Minor” (2) – Minor fault indicated. If running, drive continues to run. Enable with P950 [Minor Flt Cfg]. If not enabled, acts like a major fault. “FltCoastStop” (3) – Major fault indicated. Coast to Stop.	Default: Options:	3 = “FltCoastStop” 0 = “Ignore” 1 = “Alarm” 2 = “Flt Minor” 3 = “FltCoastStop”	RW	32-bit Integer		

## Drive (Port 0) Protection File

File	Group	No.	Display Name Full Name Description	Values	Read-Write	Data Type
PROTECTION	Motor Overload	410	<b>Motor OL Actn</b> Motor Overload Action Configures the response to a motor overload condition. If "Flt Minor" (2) is selected, enable P950 [Minor Flt Cfg] Bit 0. "Ignore" (0) – No action is taken. "Alarm" (1) – Type 1 alarm indicated. "Flt Minor" (2) – Minor fault indicated. If running, drive continues to run. Enable with P950 [Minor Flt Cfg]. If not enabled, acts like a major fault. "FltCoastStop" (3) – Major fault indicated. Coast to Stop. "Flt RampStop" (4) – Major fault indicated. Ramp to Stop. "Flt CL Stop" (5) – Major fault indicated. Current Limit Stop.	Default: 3 = "FltCoastStop" Options: 0 = "Ignore" 1 = "Alarm" 2 = "Flt Minor" 3 = "FltCoastStop" 4 = "Flt RampStop" 5 = "Flt CL Stop"	RW	32-bit Integer
		411	<b>Mtr OL at Pwr Up</b> Motor Overload At Power Up Selects the mode to use for initial value of the motor overload counter, upon drive power-up. "Assume Cold" (0) – P418 [Mtr OL Counts] will be reset to zero the next time the drive is powered up. "UseLastValue" (1) – The value of P418 [Mtr OL Counts] will be retained at power down and restored the next time the drive is powered up. "RealTimeClk" (2) – The value of P418 [Mtr OL Counts] begins to decrease at drive power down, reflecting the cooling of the motor, and stops at drive power-up or when zero is reached. This option is only available when the real time clock is active on the drive.	Default: 0 = "Assume Cold" Options: 0 = "Assume Cold" 1 = "UseLastValue" 2 = "RealTimeClk"	RW	32-bit Integer
		412	<b>Mtr OL Alarm Lvl</b> Motor Overload Alarm Level Sets the level of P418 [Mtr OL Counts] for which a motor overload alarm will occur. Useful to provide warning prior to the drive taking action that is selected by P410 [Motor OL Actn]. This alarm level is different than, and independent of, the "Alarm" action selected by P410 [Motor OL Actn].	Units: % Default: 0.00 Min/Max: 0.00 / 100.00	RW	Real
		413	<b>Mtr OL Factor</b> Motor Overload Factor Sets the minimum level of current (in percent or P26 [Motor NP Amps]) that causes the motor overload counter to increment. Current levels below this value will decrement the overload counter. For example, a service factor of 1.15 implies continuous operation up to 115% of nameplate motor current.	Default: 1.00 Min/Max: 0.20 / 2.00	RW	Real
		414	<b>Mtr OL Hertz</b> Motor Overload Hertz Selects the output frequency below which the motor operating current is derated (more sensitive) to account for the reduced self-cooling capability of typical motors, operating at slower speeds. For motors with extra low speed cooling capacity (for example 10:1 or blower cooled), reduce this setting to take full advantage of the motor being used.	Units: Hz Default: 20.00 Min/Max: 0.00 / 4096.00	RW	Real
		415	<b>Mtr OL Reset Lvl</b> Motor Overload Reset Level Sets the level that resets a motor overload condition, and allows a fault (if selected as the motor overload action) to be manually reset.	Units: % Default: 0.00 Min/Max: 0.00 / 100.00	RW	Real
		416	<b>MtrOL Reset Time</b> Motor Overload Reset Time Displays the time it will take to restart the drive after a motor overload fault has occurred and the value in P418 [Mtr OL Counts] is less than the P415 [Mtr OL Reset Lvl].	Units: Secs Default: 0.00 Min/Max: -/+99999.00	RW	Real

File	Group	No.	Display Name Full Name Description	Values	Read-Write	Data Type
PROTECTION	Motor Overload	418	<b>Mtr OL Counts</b> Motor Overload Counts Accumulated percentage of motor overload. Continuously operating the motor over 100% of the motor overload setting will increase this value to 100% and cause the action selected in P410 [Motor OL Actn] to be taken.	Units: % Default: 0.00 Min/Max: 0.00 / 100.00	RO	Real
		419	<b>Mtr OL Trip Time</b> Motor Overload Trip Time Displays the inverse of the motor overload time, equal to the number of seconds before P418 [Mtr OL Counts] reaches 100%, and the motor overload action is taken.	Units: Secs Default: 99999 Min/Max: 0 / 99999	RO	32-bit Integer

File	Group	No.	Display Name Full Name Description	Values	Read-Write	Data Type
PROTECTION	Load Limits	420	 <b>Drive OL Mode</b> Drive Overload Mode Selects the action to take when the drive detects that it is being overloaded. Reducing current limit and / or PWM frequency may allow the drive to continue running without faulting. When using a sine wave output filter, set this parameter to 1 "Reduce CLmt" or 0 "Disabled."	Default: 3 = "Both PWM 1st" Options: 0 = "Disabled" 1 = "Reduce CLmt" 2 = "Reduce PWM" 3 = "Both PWM 1st"	RW	32-bit Integer
		421	 <b>Current Lmt Sel</b> Current Limit Select Selects the source for the current limit value. When the load is large enough to cause current that equals or exceeds this value, the output frequency will automatically adjust (increase or decrease, as required) to attempt limiting the output current to this value.	Default: 422 Options: 1 / 159999	RW	32-bit Integer
		422	<b>Current Limit 1</b>	Units: Amps Default: Based on Drive Rating Min/Max: Based on Drive Rating	RW	Real
		423	<b>Current Limit 2</b> Current Limit <i>n</i> Constant values that can be used as sources for P421 [Current Lmt Sel]. The value of these parameters should be checked if changes have been made to P305 [Voltage Class] and/or P306 [Duty Rating].			
		424	<b>Active Cur Lmt</b> Active Current Limit Displays the current that is actively being used, including the automatic foldback effect from the drive overload function (see P420 [Drive OL Mode]).	Units: Amps Default: 0.00 Min/Max: -/+P21 [Rated Amps] x 8	RO	Real
		425	<b>Current Rate Lmt</b> Current Rate Limit Sets the largest allowable rate of change for the torque producing current reference (Iq). This number is scaled in percent of rated motor current for every 250 microseconds.	Units: % Default: 400.00 Min/Max: 1.00 / 800.00	RW	Real
		426	<b>Regen Power Lmt</b> Regenerative Power Limit Sets the limit for power flow from the motor to the drive (regenerating). Only active in Flux Vector (FV) control modes.	Units: % Default: -50.00 Min/Max: -800.00 / 0.00	RW	Real
		427	<b>Motor Power Lmt</b> Motor Power Limit Sets the limit for power flow from the drive to the motor (motoring). Only active in Flux Vector (FV) control modes.	Units: % Default: 200.00 Min/Max: 0.00 / 800.00	RW	Real
		428	<b>Current Limit Kd</b> Current Limit Derivative Gain Derivative gain for the current limit function. This parameter is not functional when any of the FV motor control modes are selected.	Units: Secs Default: 760.0 Min/Max: 0.0 / 1000000.0	RW	Real
		429	<b>Current Limit Ki</b> Current Limit Integral Gain Integral gain for the current limit function. This parameter is not functional when any of the FV motor control modes are selected.	Default: 680.0 Min/Max: 0.0 / 10000.0	RW	Real

File	Group	No.	Display Name Full Name Description	Values		Read-Write	Data Type																																																			
PROTECTION	Load Limits	430	<b>Current Limit Kp</b> Current Limit Proportional Gain Proportional gain for the current limit function. This parameter is not functional when any of the FV motor control modes are selected.	Units: Hz/A Default: 290.0 Min/Max: 0.0 / 1000000.0		RW	Real																																																			
		431	<b>Id Lo FreqCur Kp</b> Id Low Frequency Current Kp Current limit proportional gain active at very low operating frequencies. This parameter is not functional when any of the FV motor control modes are selected.	Units: V/A Default: 50.0 Min/Max: 0.0 / 100000.0		RW	Real																																																			
		432	<b>Iq Lo FreqCur Kp</b> Iq Low Frequency Current Kp Current limit proportional gain active at very low operating frequencies. This parameter is not functional when any of the FV motor control modes are selected.	Units: V/A Default: 50.0 Min/Max: 0.0 / 100000.0		RW	Real																																																			
		433	<b>Jerk Gain</b> Jerk Gain Allows you to adjust the amount of S Curve or "Jerk" applied to the Accel/Decel rate.	Default: 5200.0 Min/Max: 0.0 / 1000000000.0		RW	Real																																																			
		434	<b>Shear Pin Cfg</b> Shear Pin Configure Configures operation of the shear pin function.  Options <table border="1" style="margin-left: 20px;"> <thead> <tr> <th></th> <th>Reserved</th><th>Reserved</th><th>Reserved</th><th>Reserved</th><th>Reserved</th><th>Reserved</th><th>Reserved</th><th>Reserved</th><th>Reserved</th><th>Reserved</th><th>Reserved</th><th>Reserved</th><th>Reserved</th><th>Reserved</th><th>Shear2NoAcc</th><th>Shear1NoAcc</th> </tr> </thead> <tbody> <tr> <td>Default</td> <td>0</td><td>0</td><td>0</td><td>0</td><td>0</td><td>0</td><td>0</td><td>0</td><td>0</td><td>0</td><td>0</td><td>0</td><td>0</td><td>0</td><td>0</td><td>0</td> </tr> <tr> <td>Bit</td> <td>15</td><td>14</td><td>13</td><td>12</td><td>11</td><td>10</td><td>9</td><td>8</td><td>7</td><td>6</td><td>5</td><td>4</td><td>3</td><td>2</td><td>1</td><td>0</td> </tr> </tbody> </table> Bit 0 "Shear1NoAcc" – 0 = Active during acceleration, 1 = Ignore during acceleration Bit 1 "Shear2NoAcc" – 0 = Active during acceleration, 1 = Ignore during acceleration		Reserved	Reserved	Reserved	Reserved	Reserved	Reserved	Reserved	Reserved	Reserved	Reserved	Reserved	Reserved	Reserved	Reserved	Shear2NoAcc	Shear1NoAcc	Default	0	0	0	0	0	0	0	0	0	0	0	0	0	0	0	0	Bit	15	14	13	12	11	10	9	8	7	6	5	4	3	2	1	0			RW	16-bit Integer
			Reserved	Reserved	Reserved	Reserved	Reserved	Reserved	Reserved	Reserved	Reserved	Reserved	Reserved	Reserved	Reserved	Reserved	Shear2NoAcc	Shear1NoAcc																																								
		Default	0	0	0	0	0	0	0	0	0	0	0	0	0	0	0	0																																								
		Bit	15	14	13	12	11	10	9	8	7	6	5	4	3	2	1	0																																								
		435	<b>Shear Pin 1 Actn</b>	Default: 0 = "Ignore"		RW	32-bit Integer																																																			
		438	<b>Shear Pin 2 Actn</b> Shear Pin <i>n</i> Action Configures the action to take when the output current is greater than or equal to P436/439 [Shear Pin <i>n</i> Level] for the amount of time set in P437/440 [Shear Pin <i>n</i> Time]. These two independent shear pin functions can be set up to achieve the equivalent of external overloads that have "stall" and "jam" indication. "Ignore" (0) – No action is taken. "Alarm" (1) – Type 1 alarm indicated. "Flt Minor" (2) – Minor fault indicated. If running, drive continues to run. Enable with P950 [Minor Flt Cfg]. If not enabled, acts like a major fault. "FltCoastStop" (3) – Major fault indicated. Coast to Stop. "Flt RampStop" (4) – Major fault indicated. Ramp to Stop. "Flt CL Stop" (5) – Major fault indicated. Current Limit Stop.	Options: 0 = "Ignore" 1 = "Alarm" 2 = "Flt Minor" 3 = "FltCoastStop" 4 = "Flt RampStop" 5 = "Flt CL Stop"																																																						
436	<b>Shear Pin1 Level</b>	Units: Amps		RW	Real																																																					
439	<b>Shear Pin2 Level</b> Shear Pin <i>n</i> Level Sets the value of current which will activate the shear pin function (see P435/438 [Shear Pin <i>n</i> Actn]).	Default: P21 [Rated Amps] Min/Max: 0.0 / P21 [Rated Amps] x 1.5																																																								
437	<b>Shear Pin 1 Time</b>	Units: Secs		RW	Real																																																					
440	<b>Shear Pin 2 Time</b> Shear Pin <i>n</i> Time Sets the time associated with activation of the shear pin function (see P435/438 [Shear Pin <i>n</i> Actn]).	Default: 0.00 Min/Max: 0.00 / 30.00																																																								



File	Group	No.	Display Name Full Name Description	Values		Read-Write	Data Type
PROTECTION	Load Limits	441	<b>Load Loss Action</b> Load Loss Action Configures the action to take when the load is less than or equal to P442 [Load Loss Level] for the amount of time set in P443 [Load Loss Time]. "Ignore" (0) – No action is taken. "Alarm" (1) – Type 1 alarm indicated. "Flt Minor" (2) – Minor fault indicated. If running, drive continues to run. Enable with P950 [Minor Flt Cfg]. If not enabled, acts like a major fault. "FltCoastStop" (3) – Major fault indicated. Coast to Stop. "Flt RampStop" (4) – Major fault indicated. Ramp to Stop. "Flt CL Stop" (5) – Major fault indicated. Current Limit Stop.	Default: Options:	0 = "Ignore" 0 = "Ignore" 1 = "Alarm" 2 = "Flt Minor" 3 = "FltCoastStop" 4 = "Flt RampStop" 5 = "Flt CL Stop"	RW	32-bit Integer
		442	<b>Load Loss Level</b> Load Loss Level Sets the percentage of motor nameplate torque (absolute value) associated with activation of the load loss function, P441 [Load Loss Action]. See P5 [Torque Cur Fdbk] motor nameplate torque.	Units: Default: Min/Max:	% 200.00 0.00 / 800.00	RW	Real
		443	<b>Load Loss Time</b> Load Loss Time Sets the time associated with activation of the load loss function (see P441 [Load Loss Action]).	Units: Default: Min/Max:	Secs 0.00 0.00 / 300.00	RW	Real
		444	<b>OutPhaseLossActn</b> Output Phase Loss Action Selects action to take if output phase loss is detected. "Ignore" (0) – No action is taken. "Alarm" (1) – Type 1 alarm indicated. "Flt Minor" (2) – Minor fault indicated. If running, drive continues to run. Enable with P950 [Minor Flt Cfg]. If not enabled, acts like a major fault. "FltCoastStop" (3) – Major fault indicated. Coast to Stop. "Flt RampStop" (4) – Major fault indicated. Ramp to Stop. "Flt CL Stop" (5) – Major fault indicated. Current Limit Stop.	Default: Options:	0 = "Ignore" 0 = "Ignore" 1 = "Alarm" 2 = "Flt Minor" 3 = "FltCoastStop" 4 = "Flt RampStop" 5 = "Flt CL Stop"	RW	32-bit Integer
		445	<b>Out PhaseLossLvl</b> Output Phase Loss Level Sets the threshold level which is used to determine an output phase loss condition. Each motor phase must exceed this value. Decreasing this parameter's value lowers sensitivity.	Default: Min/Max:	200 0 / 1000	RW	32-bit Integer

File	Group	No.	Display Name Full Name Description	Values	Read-Write	Data Type
PROTECTION	Power Loss	449	<b>Power Loss Actn</b> Power Loss Action Configures the drive's response to a power loss timeout condition. Time is set in P452/455 [Pwr Loss n Time]. "Ignore" (0) – No action is taken. "Alarm" (1) – Type 1 alarm indicated. "Flt Minor" (2) – Minor fault indicated. If running, drive continues to run. Enable with P950 [Minor Flt Cfg]. If not enabled, acts like a major fault. "FltCoastStop" (3) – Major fault indicated. Coast to Stop.	Default: 1 = "Alarm" Options: 0 = "Ignore" 1 = "Alarm" 2 = "Flt Minor" 3 = "FltCoastStop"	RW	32-bit Integer
		450	<b>Pwr Loss Mode A</b>	Default: 0 = "Coast"	RW	32-bit Integer
		453	<b>Pwr Loss Mode B</b> Power Loss Mode A, B Configures the drive's response to a loss of input power as sensed by a drop in bus voltage. The bus voltage drop is specified in P451/454 [Pwr Loss n Level] and compared to the bus voltage memory P12 [DC Bus Memory]. "Coast" (0) - When a power loss occurs, the drive stops modulating. Use this option on low inertia loads. "Decel" (1) - The drive will decelerate the motor to help maintain the bus voltage. Use this option on high inertia loads. "Continue" (2) - The drive will continue to run through a power loss. Improper use of this option can cause drive damage.	Options: 0 = "Coast" 1 = "Decel" 2 = "Continue"		
		451	<b>Pwr Loss A Level</b>	Units: V DC	RW	Real
		454	<b>Pwr Loss B Level</b> Power Loss Mode A, B Level Sets the bus voltage level at which ride-through begins and modulation ends. When bus voltage falls below this level, the drive prepares for an automatic restart. Enter a percentage of the bus voltage derived from the high voltage setting for the voltage class. The trip level is calculated as: P7 [DC Bus Memory] - P451 [Pwr Loss A Level] or P454 [Pwr Loss B Level] For example: on a 400/480V drive, $0.3913 \times 480 \text{ VAC} \times \sqrt{2} = 265.62 \text{ VDC}$	Default: P20 [Rated Volts] x 0.3913 Min/Max: 0.0 / P20 [Rated Volts] x 1.41		
		452	<b>Pwr Loss A Time</b>	Units: Secs	RW	Real
		455	<b>Pwr Loss B Time</b> Power Loss Mode A, B Time Sets the time that the drive will remain in power loss mode before a fault is detected.	Default: 2.00 Min/Max: 0.00 / 60.00		
		456	<b>PwrLoss RT BusKp</b> Power Loss Ride Through Bus Kp Proportional gain that adjusts the response of the bus regulator when power loss ride through is enabled and detected. This parameter is not functional when any of the FV motor control modes are selected.	Units: A/V Default: 585.0 Min/Max: 0.0 / 1000000.0	RW	Real
		457	<b>PwrLoss RT BusKd</b> Power Loss Ride Through Bus Kd Derivative gain that adjusts the response of the bus regulator when power loss ride through is enabled and detected. This parameter is not functional when any of the FV motor control modes are selected.	Units: Secs Default: 50.0 Min/Max: 0.0 / 1000000.0	RW	Real
		458	<b>PwrLoss RT ACRKp</b> Power Loss Ride Through Active Current Regulator Kp Proportional gain that adjusts the response of the active current regulator portion of the bus regulator when power loss ride through is enabled and detected. This parameter is not functional when any of the FV motor control modes are selected.	Units: Hz/A Default: 524.0 Min/Max: 0.0 / 100000.0	RW	Real
459	<b>PwrLoss RT ACRKi</b> Power Loss Ride Through Active Current Regulator Ki Integral gain that adjusts the response of the active current regulator portion of the bus regulator when power loss ride through is enabled and detected. This parameter is not functional when any of the FV motor control modes are selected.	Units: Hz/A Default: 2045.0 Min/Max: 0.0 / 50000.0	RW	Real		

File	Group	No.	Display Name Full Name Description	Values	Read-Write	Data Type
PROTECTION	Power Loss	460	<b>UnderVltg Action</b> Under Voltage Action Configures the drive's response to an under voltage event configured in P461 [UnderVltg Level]. "Ignore" (0) – No action is taken. "Alarm" (1) – Type 1 alarm indicated. "Flt Minor" (2) – Minor fault indicated. If running, drive continues to run. Enable with P950 [Minor Flt Cfg]. If not enabled, acts like a major fault. "FltCoastStop" (3) – Major fault indicated. Coast to Stop. "Flt RampStop" (4) – Major fault indicated. Ramp to Stop. "Flt CL Stop" (5) – Major fault indicated. Current Limit Stop.	Default: 3 = "FltCoastStop" Options: 0 = "Ignore" 1 = "Alarm" 2 = "Flt Minor" 3 = "FltCoastStop" 4 = "Flt RampStop" 5 = "Flt CL Stop"	RW	32-bit Integer
		461	<b>UnderVltg Level</b> Under Voltage Level DC line voltage level below which an undervoltage event occurs.	Units: V AC Default: Based on Drive Rating and Voltage Class Min/Max: 0.00 / Based on Drive Voltage (230, 460, 600, and 690)	RW	Real
		462	<b>InPhase LossActn</b> Input Phase Loss Action Selects the action to take if an input phase loss is detected. The input phase loss function helps protect the drive bus capacitors from excessive bus ripple. The bus ripple threshold set by P463 [InPhase Loss Lvl]. "Ignore" (0) – No action is taken. <b>Important:</b> Operating in a phase loss condition will seriously degrade the reliability of the drive. "Alarm" (1) – Type 1 alarm indicated. "Flt Minor" (2) – Minor fault indicated. If running, drive continues to run. Enable with P950 [Minor Flt Cfg]. If not enabled, acts like a major fault. "FltCoastStop" (3) – Major fault indicated. Coast to Stop. "Flt RampStop" (4) – Major fault indicated. Ramp to Stop. "Flt CL Stop" (5) – Major fault indicated. Current Limit Stop.	Default: 3 = "FltCoastStop" Options: 0 = "Ignore" 1 = "Alarm" 2 = "Flt Minor" 3 = "FltCoastStop" 4 = "Flt RampStop" 5 = "Flt CL Stop"	RW	32-bit Integer
		463	<b>InPhase Loss Lvl</b> Input Phase Loss Level Sets the threshold at which the DC bus voltage ripple triggers an Input Phase Loss fault. Input phase loss is assumed when the DC bus voltage ripple exceeds the tolerance set by this parameter. Setting a larger value permits a higher bus voltage ripple without causing the drive to fault. The default value of 325 is equal to the expected ripple level for a full rated motor running at half load with single phase input.	Default: 325 Min/Max: 10 / 32767	RW	32-bit Integer
		464	<b>DC Bus Mem Reset</b> Direct Current Bus Memory Reset Forces a manual update to P12 [DC Bus Memory], which is automatically initialized upon power-up or precharge and continually updated during normal operation. A transition from 0 to 1 will cause a bus memory update. However, the update will be ignored if the command cannot be acted upon within 30 seconds because the drive is regenerating or is firing the dynamic brake. A manual reset is rarely required, but may occur when input voltage is abnormally high or low for an extended period of time followed by a fast return to a nominal value.	Default: 0 = "Disabled" Options: 0 = "Disabled" 1 = "Enabled"	RW	32-bit Integer

File	Group	No.	Display Name Full Name Description	Values	Read-Write	Data Type
PROTECTION	Ground Fault	466	<p><b>Ground Warn Actn</b> Ground Warning Action Selects the action to take when a ground current event is detected. The Ground Warning feature detects a ground current that exceeds the level set in P467 [Ground Warn Lvl]. An alarm is displayed until the ground current falls below the level set in P467 [Ground Warn Lvl] while the drive continues to run. A fault will stop the drive. A fault cannot be cleared until the ground current is below the level set in P467 [Ground Warn Lvl]. "Ignore" (0) – No action is taken. "Alarm" (1) – Type 1 alarm indicated. "Flt Minor" (2) – Minor fault indicated. If running, drive continues to run. Enable with P950 [Minor Flt Cfg]. If not enabled, acts like a major fault. "FltCoastStop" (3) – Major fault indicated. Coast to Stop. "Flt RampStop" (4) – Major fault indicated. Ramp to Stop. "Flt CL Stop" (5) – Major fault indicated. Current Limit Stop.</p>	<p>Default: 0 = "Ignore" Options: 0 = "Ignore" 1 = "Alarm" 2 = "Flt Minor" 3 = "FltCoastStop" 4 = "Flt RampStop" 5 = "Flt CL Stop"</p>	RW	32-bit Integer
		467	<p><b>Ground Warn Lvl</b> Ground Warning Level Sets the level at which a ground warning alarm will occur.</p>	<p>Units: Amps Default: 4.00 Min/Max: 1.00 / 5.00</p>	RW	Real

File	Group	No.	Display Name Full Name Description	Values	Read-Write	Data Type																																																		
PROTECTION	Predictive Maintenance	469	<b>PredMaint Sts</b> Predictive Maintenance Status Status of predictive maintenance elapsed life relative to the programmed event level. A value of 1 = event level has been exceeded. Bit 15 is a master bit which = 1 when 1 or more individual bits = 1.  Options <table border="1"> <tr> <td></td> <td>Master</td> <td>Reserved</td> <td>Reserved</td> <td>Reserved</td> <td>Reserved</td> <td>Reserved</td> <td>Reserved</td> <td>Reserved</td> <td>Reserved</td> <td>Reserved</td> <td>Mch Lube</td> <td>Mch Bearing</td> <td>Mtr Lube</td> <td>Mtr Bearing</td> <td>Internal Fan</td> <td>Heatsink Fan</td> </tr> <tr> <td>Default</td> <td>0</td> <td>0</td> <td>0</td> <td>0</td> <td>0</td> <td>0</td> <td>0</td> <td>0</td> <td>0</td> <td>0</td> <td>0</td> <td>0</td> <td>0</td> <td>0</td> <td>0</td> </tr> <tr> <td>Bit</td> <td>15</td> <td>14</td> <td>13</td> <td>12</td> <td>11</td> <td>10</td> <td>9</td> <td>8</td> <td>7</td> <td>6</td> <td>5</td> <td>4</td> <td>3</td> <td>2</td> <td>1</td> <td>0</td> </tr> </table> 0 = False 1 = True		Master	Reserved	Reserved	Reserved	Reserved	Reserved	Reserved	Reserved	Reserved	Reserved	Mch Lube	Mch Bearing	Mtr Lube	Mtr Bearing	Internal Fan	Heatsink Fan	Default	0	0	0	0	0	0	0	0	0	0	0	0	0	0	0	Bit	15	14	13	12	11	10	9	8	7	6	5	4	3	2	1	0		RO	16-bit Integer
			Master	Reserved	Reserved	Reserved	Reserved	Reserved	Reserved	Reserved	Reserved	Reserved	Mch Lube	Mch Bearing	Mtr Lube	Mtr Bearing	Internal Fan	Heatsink Fan																																						
		Default	0	0	0	0	0	0	0	0	0	0	0	0	0	0	0																																							
		Bit	15	14	13	12	11	10	9	8	7	6	5	4	3	2	1	0																																						
		470	<b>PredMaintAmbTemp</b> Predictive Maintenance Ambient Temperature Used to predict cooling fan life, and possibly the life of other temperature dependent components in the future. Changes to this parameter affect the total life and remaining life, meaning that only one temperature can be programmed for the entire life of the drive.	Units: DegC Default: 50.00 Min/Max: 0.00 / 50.00	RW	Real																																																		
		471	<b>PredMaint Rst En</b> Predictive Maintenance Reset Enable Enables P472 [PredMaint Reset] to execute a reset of the selected elapsed life parameter. Any single reset in P472 [PredMaint Reset] will force this parameter back to 0 (disabled), so that only one elapsed life parameter can be reset at a time. This parameter is only reset when Set Defaults "All" (not recommended) is executed.	Default: Current Selection Options: 0 = "Disable" 1 = "Enable"	RW	32-bit Integer																																																		
		472	<b>PredMaint Reset</b> Predictive Maintenance Reset Resets predictive maintenance elapsed life parameters, one at a time. Enabled by P471 [PredMaint Rst En]. This parameter is only reset when Set Defaults "All" (not recommended) is executed.	Default: Current Selection Options: 0 = "Ready" 1 = "HS Fan Life" (1) 2 = "In Fan Life" (1) 3 = "MtrBrng Life" 4 = "MtrLube Hrs" 5 = "MchBrng Life" 6 = "MchLube Hrs"  (1) Frames 1...7 only.	RW	32-bit Integer																																																		
		481	<b>755 (8+) CbFan Derate</b> Cabinet Fan Derate Derating factor applied to P482 [CbFan TotalLife]. Used to adjust total fan life for poor air quality or vibration.	Default: 1.00 Min/Max: 0.01 / 1.00	RW	Real																																																		
482	<b>755 (8+) CbFan TotalLife</b> Cabinet Fan Total Life Total number of hours expected over the life of a single cabinet fan. Calculated as a function of fan manufacturer's life data (from frame rating table), P470 [PredMaintAmbTemp] and P481 [CbFan Derate].	Units: Hrs Default: 0.00 Min/Max: 0.00 / 21474836.47 (31 bits)	RO	32-bit Integer																																																				
483	<b>755 (8+) CbFan ElpsdLife</b> Cabinet Fan Elapsed Life Accumulated hours of cabinet fan run time. Frame 8 drives have a single converter, and therefore a single cabinet fan. The value of this parameter reflects the elapsed life of that fan. Frame 9 drives have two converters, and therefore two cabinet fans. Frame 10 drives have three converters, and therefore three cabinet fans. For frame 9 and 10 drives, the value of this parameter reflects the longest elapsed life of all the cabinet fans. Individual elapsed life values are available at parameters 138 [C1 CbFanElpsdLif], 238 [C2 CbFanElpsdLif], and 338 [C3 CbFanElpsLif] in port 11.	Units: Hrs Default: 0.00 Min/Max: 0.00 / 21474836.47 (31 bits)	RO	32-bit Integer																																																				

File	Group	No.	Display Name Full Name Description	Values	Read-Write	Data Type
PROTECTION	Predictive Maintenance	484	<b>755 (8+) CbFan RemainLife</b> Cabinet Fan Remaining Life Remaining number of hours until estimated end of life for cabinet fans, and is the difference between P482 [CbFan TotalLife] and P483 [CbFan ElpsdLife]. All negative values of this parameter need to be treated as excessive use (> 100%), and trigger the appropriate action chosen by P486 [CbFan EventActn]. Frame 8 drives have a single converter, and therefore have a single cabinet fan. The value of this parameter reflects the remaining life of that fan. Frame 9 drives have two converters, and therefore two cabinet fans. Frame 10 drives have three converters, and therefore three cabinet fans. For frame 9 and 10 drives, the value of this parameter reflects the shortest remaining life of all the cabinet fans.	Units: Hrs Default: 0.00 Min/Max: -21474836.48 / 21474836.47	RO	32-bit Integer
		485	<b>755 (8+) CbFan EventLevel</b> Cabinet Fan Event Level Percent of total expected cabinet fan life for which an early warning alarm or fault can be programmed.	Units: % Default: 80.000 Min/Max: 0.000 / 100.000	RW	Real
		486	<b>755 (8+) CbFan EventActn</b> Cabinet Fan Event Action Configures the response to a cabinet fan event, which occurs when P485 [CbFan EventLevel] is met or exceeded. "Ignore" (0) – No action is taken. "Alarm" (1) – Type 1 alarm indicated. "Flt Minor" (2) – Minor fault indicated. If running, drive continues to run. Enable with P950 [Minor Flt Cfg]. If not enabled, acts like a major fault. "FltCoastStop" (3) – Major fault indicated. Coast to Stop. "Flt RampStop" (4) – Major fault indicated. Ramp to Stop. "Flt CL Stop" (5) – Major fault indicated. Current Limit Stop.	Default: 0 = "Ignore" Options: 0 = "Ignore" 1 = "Alarm" 2 = "Flt Minor" 3 = "FltCoastStop" 4 = "Flt RampStop" 5 = "Flt CL Stop"	RW	32-bit Integer
		488	<b>HSFan Derate</b> Heatsink Fan Derate Derating factor applied to P489 [HSFan TotalLife]. Used to adjust total fan life for poor air quality or vibration.	Default: 1.00 Min/Max: 0.01 / 1.00	RW	Real
		489	<b>HSFan TotalLife</b> Heatsink Fan Total Life Total number of hours expected over the life of a single heatsink fan. Calculated as a function of fan manufacturer's life data (from frame rating table), P470 [PredMaintAmbTemp] and P488 [HSFan Derate].	Units: Hrs Default: 0.00 / Based on Drive Rating Min/Max: 0.00 / 21474836.47 (31 bits)	RO	32-bit Integer
		490	<b>HSFan ElpsdLife</b> Heatsink Fan Elapsed Life Accumulated hours of heatsink fan run time. Use P472 [PredMaint Reset] to reset this parameter. <b>755 (8+)</b> Frame 8 drives have a single inverter, and therefore have a single heatsink fan. The value of this parameter reflects the elapsed life of that fan. Frame 9 drives have two inverters, and therefore two heatsink fans. Frame 10 drives have three inverters, and therefore three heatsink fans. For frame 9 and 10 drives, the value of this parameter reflects the longest elapsed life of all the heatsink fans. Individual elapsed life values are available at parameters 128 [I1 HSFanElpsdLif], 228 [I2 HSFanElpsdLif] and 328 [I3 HSFanElpsdLif] in port 10.	Units: Hrs Default: 0.00 / Based on Drive Rating Min/Max: 0.00 / 21474836.47 (31 bits)	RO	32-bit Integer

File	Group	No.	Display Name Full Name Description	Values		Read-Write	Data Type
PROTECTION	Predictive Maintenance	491	<b>HSFan RemainLife</b> Heatsink Fan Remaining Life Remaining number of hours until estimated end of life for heatsink fans, and is the difference between P489 [HSFan TotalLife] and P490 [HSFan ElpsdLife]. All negative values of this parameter need to be treated as excessive use (> 100%), and trigger the appropriate action chosen by P493 [HSFan EventActn]. Use P472 [PredMaint Reset] to reset this parameter. <b>755 (8+)</b> Frame 8 drives have a single inverter, and therefore a single heatsink fan. The value of this parameter reflects the remaining life of that fan. Frame 9 drives have two inverters, and therefore two heatsink fans. Frame 10 drives have three inverters, and therefore three heatsink fans. For frame 9 and 10 drives, the value of this parameter reflects the shortest remaining life of all the heatsink fans.	Units: Hrs Default: 0.00 / Based on Drive Rating Min/Max: -21474836.48 / 21474836.47		RO	32-bit Integer
		492	<b>HSFan EventLevel</b> Heatsink Fan Event Level Percent of total expected heatsink fan life for which an early warning alarm or fault can be programmed.	Units: % Default: 80.000 Min/Max: 0.000 / 100.000		RW	Real
		493	<b>HSFan EventActn</b> Heatsink Fan Event Action Configures the response to a heatsink fan event, which occurs when P492 [HSFan EventLevel] is met or exceeded. "Ignore" (0) – No action is taken. "Alarm" (1) – Type 1 alarm indicated. "Flt Minor" (2) – Minor fault indicated. If running, drive continues to run. Enable with P950 [Minor Flt Cfg]. If not enabled, acts like a major fault. "FltCoastStop" (3) – Major fault indicated. Coast to Stop. "Flt RampStop" (4) – Major fault indicated. Ramp to Stop. "Flt CL Stop" (5) – Major fault indicated. Current Limit Stop.	Default: 0 = "Ignore" Options: 0 = "Ignore" 1 = "Alarm" 2 = "Flt Minor" 3 = "FltCoastStop" 4 = "Flt RampStop" 5 = "Flt CL Stop"		RW	32-bit Integer
		494	<b>HSFan ResetLog</b> Heatsink Fan Reset Log Total number of resets performed on the P490 [HSFan ElpsdLife] parameter. <b>Note:</b> This parameter is not used by PowerFlex 755 Frame 8 drives and larger.	Default: 0 Min/Max: 0 / 255 (unsigned 8 bits)		RO	32-bit Integer
		495	<b>InFan Derate</b> Internal Fan Derate Derating factor applied to P496 [InFan TotalLife]. Used to adjust total fan life for poor air quality or vibration.	Default: 1.00 Min/Max: 0.01 / 1.00		RW	Real
		496	<b>InFan TotalLife</b> Internal Fan Total Life Total number of hours expected over the life of an internal fan. Calculated as a function of fan manufacturer's life data (from frame rating table), P470 [PredMaintAmbTemp] and P495 [InFan Derate]. <b>755 (8+)</b> Total number of hours expected over the life of a single internal fan. Calculated as a function of fan manufacturer's life data (from frame rating table), P470 [PredMaintAmbTemp] and P495 [InFan Derate].	Units: Hrs Default: 0.00 Min/Max: 0.00 / 21474836.47 (31 bits)		RO	32-bit Integer

File	Group	No.	Display Name Full Name Description	Values		Read-Write	Data Type
PROTECTION	Predictive Maintenance	497	<b>InFan ElpsdLife</b> Internal Fan Elapsed Life Accumulated hours of internal stirring fan run time. Note: Frames 6 and 7 run continuously, and frames 2...5 are controlled by firmware. Use P472 [PredMaint Reset] to reset this parameter.  Frame 8 drives have a single inverter, and therefore a single internal stirring fans. The value of this parameter reflects the elapsed life of that internal fan. <b>755 (8+)</b>  Frame 9 drives have two inverters, and therefore two internal fans. Frame 10 drives have three inverters, and therefore three internal fans. For frame 9 and 10 drives, the value of this parameter reflects the longest elapsed life of the internal fans. Individual elapsed life values are available at parameters 129 [1 InFanElpsdLif], 229 [2 InFanElpsdLif], and 329 [3 InFanElpsdLif] in port 10.	Units: Hrs Default: 0.00 Min/Max: 0.00 / 21474836.47 (31 bits)	RO	32-bit Integer	
		498	<b>InFan RemainLife</b> Internal Fan Remaining Life Remaining number of hours until estimated end of life for internal stirring fans, and is the difference between P496 [InFan TotalLife] and P497 [InFan ElpsdLife]. All negative values of this parameter need to be treated as excessive use (> 100%), and trigger the appropriate action chosen by P500 [InFan EventActn]. Use P472 [PredMaint Reset] to reset this parameter.  <b>755 (8+)</b> Frame 8 drives have a single inverter, and therefore a single internal stirring fan. The value of this parameter reflects the remaining life of that internal fan.  Frame 9 drives have two inverters, and therefore two internal fans. Frame 10 drives have three inverters, and therefore three internal fans. For frame 9 and 10 drives, the value of this parameter reflects the shortest remaining life of all the internal fans.	Units: Hrs Default: 0.00 Min/Max: -21474836.48 / 21474836.47	RO	32-bit Integer	
		499	<b>InFan EventLevel</b> Internal Fan Event Level Percent of total expected internal stirring fan life for which an early warning alarm or fault can be programmed.	Units: % Default: 80.000 Min/Max: 0.000 / 100.000	RW	Real	
		500	<b>InFan EventActn</b> Internal Fan Event Action Configures the response to an internal stirring fan event, which occurs when P499 [InFan EventLevel] is met or exceeded. "Ignore" (0) – No action is taken. "Alarm" (1) – Type 1 alarm indicated. "Flt Minor" (2) – Minor fault indicated. If running, drive continues to run. Enable with P950 [Minor Flt Cfg]. If not enabled, acts like a major fault. "FltCoastStop" (3) – Major fault indicated. Coast to Stop. "Flt RampStop" (4) – Major fault indicated. Ramp to Stop. "Flt CL Stop" (5) – Major fault indicated. Current Limit Stop.	Default: 0 = "Ignore" Options: 0 = "Ignore" 1 = "Alarm" 2 = "Flt Minor" 3 = "FltCoastStop" 4 = "Flt RampStop" 5 = "Flt CL Stop"	RW	32-bit Integer	
		501	<b>InFan ResetLog</b> Internal Fan Reset Log Total number of resets performed on the P497 [InFan ElpsdLife] parameter. <b>Note:</b> This parameter is not used by PowerFlex 755 Frame 8 drives and larger.	Default: 0 Min/Max: 0 / 255 (unsigned 8 bits)	RO	32-bit Integer	



File	Group	No.	Display Name Full Name Description	Values		Read-Write	Data Type
PROTECTION	Predictive Maintenance	502	<b>MtrBrngTotalLife</b> Motor Bearing Total Life Total number of hours expected over the life of the motor bearings.	Units: Default: Min/Max:	Hrs 0.00 0.00 / 21474836.47 (31 bits)	RW	32-bit Integer
		503	<b>MtrBrngElpsdLife</b> Motor Bearing Elapsed Life Accumulated hours of motor bearing run time. Hours are accumulated any time the drive is running greater than zero speed. Use P472 [PredMaint Reset] to reset this parameter.	Units: Default: Min/Max:	Hrs 0.00 0.00 / 21474836.47 (31 bits)	RO	32-bit Integer
		504	<b>MtrBrngRemainLif</b> Motor Bearing Remaining Life Remaining number of hours until estimated end of life for motor bearings, and is the difference between P502 [MtrBrngTotalLife] and P503 [MtrBrngElpsdLife]. Use P472 [PredMaint Reset] to reset this parameter.	Units: Default: Min/Max:	Hrs 0.00 -21474836.48 / 21474836.47	RO	32-bit Integer
		505	<b>MtrBrngEventLvl</b> Motor Bearing Event Level Percent of total expected motor bearing life for which an early warning alarm or fault can be programmed.	Units: Default: Min/Max:	% 80.000 0.000 / 100.000	RW	Real
		506	<b>MtrBrngEventActn</b> Motor Bearing Event Action Configures the response to a motor bearing event, which occurs when P505 [MtrBrngEventLvl] is met or exceeded. "Ignore" (0) – No action is taken. "Alarm" (1) – Type 1 alarm indicated. "Flt Minor" (2) – Minor fault indicated. If running, drive continues to run. Enable with P950 [Minor Flt Cfg]. If not enabled, acts like a major fault. "FltCoastStop" (3) – Major fault indicated. Coast to Stop. "Flt RampStop" (4) – Major fault indicated. Ramp to Stop. "Flt CL Stop" (5) – Major fault indicated. Current Limit Stop.	Default: Options:	0 = "Ignore" 0 = "Ignore" 1 = "Alarm" 2 = "Flt Minor" 3 = "FltCoastStop" 4 = "Flt RampStop" 5 = "Flt CL Stop"	RW	32-bit Integer
		507	<b>MtrBrng ResetLog</b> Motor Bearing Reset Log Total number of resets performed on the P503 [MtrBrngElpsdLife] parameter.	Default: Min/Max:	0 0 / 255 (unsigned 8 bits)	RO	32-bit Integer
		508	<b>MtrLubeElpsdHrs</b> Motor Lubricant Elapsed Hours Accumulated hours since the most recent lubrication of the motor bearings. Can be reset without restriction. Use P472 [PredMaint Reset] to reset this parameter.	Units: Default: Min/Max:	Hrs 0.00 0.00 / 21474836.47	RO	32-bit Integer
		509	<b>MtrLubeEventLvl</b> Motor Lubricant Event Level Number of hours between scheduled lubrications of the motor bearings. Used for an early warning alarm or fault according to P510 [MtrLubeEventActn]. Event is disabled when set to 0.	Units: Default: Min/Max:	Hrs 0.000 0.000 / 2147483648.000	RW	Real
		510	<b>MtrLubeEventActn</b> Motor Lubricant Event Action Configures the response to a motor bearing lubrication event, which occurs when P509 [MtrLubeEventLvl] is met or exceeded. "Ignore" (0) – No action is taken. "Alarm" (1) – Type 1 alarm indicated. "Flt Minor" (2) – Minor fault indicated. If running, drive continues to run. Enable with P950 [Minor Flt Cfg]. If not enabled, acts like a major fault. "FltCoastStop" (3) – Major fault indicated. Coast to Stop. "Flt RampStop" (4) – Major fault indicated. Ramp to Stop. "Flt CL Stop" (5) – Major fault indicated. Current Limit Stop.	Default: Options:	0 = "Ignore" 0 = "Ignore" 1 = "Alarm" 2 = "Flt Minor" 3 = "FltCoastStop" 4 = "Flt RampStop" 5 = "Flt CL Stop"	RW	32-bit Integer

File	Group	No.	Display Name Full Name Description	Values		Read-Write	Data Type
PROTECTION	Predictive Maintenance	511	<b>MchBrngTotalLife</b> Machine Bearing Total Life Total number of hours expected over the life of the machine bearings.	Units: Default: Min/Max:	Hrs Current Value 0.00 / 21474836.47	RW	32-bit Integer
		512	<b>MchBrngElpsdLife</b> Machine Bearing Elapsed Life Accumulated hours of machine bearing run time. Use P472 [PredMaint Reset] to reset this parameter.	Units: Default: Min/Max:	Hrs 0.00 0.00 / 21474836.47	RO	32-bit Integer
		513	<b>MchBrngRemainLif</b> Machine Bearing Remaining Life Remaining number of hours until estimated end of life for machine bearings, and is the difference between Machine Bearing Total Life and Machine Bearing Elapsed Life. Use P472 [PredMaint Reset] to reset this parameter.	Units: Default: Min/Max:	Hrs 0.00 -21474836.48 / 21474836.47	RO	32-bit Integer
		514	<b>MchBrngEventLvl</b> Machine Bearing Event Level Percent of total expected machine bearing life for which an early warning alarm or fault can be programmed.	Units: Default: Min/Max:	% 80.000 0.000 / 100.000	RW	Real
		515	<b>MchBrngEventActn</b> Machine Bearing Event Action Configures the response to a machine bearing event, which occurs when P514 [MchBrngEventLvl] is met or exceeded. "Ignore" (0) – No action is taken. "Alarm" (1) – Type 1 alarm indicated. "Flt Minor" (2) – Minor fault indicated. If running, drive continues to run. Enable with P950 [Minor Flt Cfg]. If not enabled, acts like a major fault. "FltCoastStop" (3) – Major fault indicated. Coast to Stop. "Flt RampStop" (4) – Major fault indicated. Ramp to Stop. "Flt CL Stop" (5) – Major fault indicated. Current Limit Stop.	Default: Options:	0 = "Ignore" 0 = "Ignore" 1 = "Alarm" 2 = "Flt Minor" 3 = "FltCoastStop" 4 = "Flt RampStop" 5 = "Flt CL Stop"	RW	32-bit Integer
		516	<b>MchBrngResetLog</b> Machine Bearing Reset Log Total number of resets performed on the P512 [MchBrngElpsdLife] parameter.	Default: Min/Max:	0 0 / 255	RO	32-bit Integer
		517	<b>MchLubeElpsdHrs</b> Machine Lubricant Elapsed Hours Accumulated machine hours since the most recent lubrication of the machine bearings. Can be reset without restriction. Use P472 [PredMaint Reset] to reset this parameter.	Units: Default: Min/Max:	Hrs 0.00 0.00 / 21474836.47	RO	32-bit Integer
		518	<b>MchLubeEventLvl</b> Machine Lubricant Event Level Number of hours between scheduled lubrications of the machine bearings. Used for an early warning alarm or fault according to P519 [MchLubeEventActn]. Event is disabled when set to 0.	Units: Default: Min/Max:	Hrs 0.000 0.000 / 2147483648.000	RW	Real
		519	<b>MchLubeEventActn</b> Machine Lubricant Event Action Configures the response to a machine bearing lubrication event, which occurs when P518 [MchLubeEventLvl] is met or exceeded. "Ignore" (0) – No action is taken. "Alarm" (1) – Type 1 alarm indicated. "Flt Minor" (2) – Minor fault indicated. If running, drive continues to run. Enable with P950 [Minor Flt Cfg]. If not enabled, acts like a major fault. "FltCoastStop" (3) – Major fault indicated. Coast to Stop. "Flt RampStop" (4) – Major fault indicated. Ramp to Stop. "Flt CL Stop" (5) – Major fault indicated. Current Limit Stop.	Default: Options:	0 = "Ignore" 0 = "Ignore" 1 = "Alarm" 2 = "Flt Minor" 3 = "FltCoastStop" 4 = "Flt RampStop" 5 = "Flt CL Stop"	RW	32-bit Integer

File	Group	No.	Display Name Full Name Description	Values	Read-Write	Data Type
PROTECTION	Emergency Override	1680	<b>DI EmergencyOVRD</b> Digital Input Emergency Override Select a digital input that is used to enable and disable emergency override. Connect the digital input to circuitry that closes, or energizes, to enable emergency override. <b>Important:</b> This digital input does not function as a valid stop source for the purposes of Fault 152 'No Stop Source'. To avoid that fault do one of the following: <ul style="list-style-type: none"> <li>• Program another digital input for DI M Run or DI M Stop</li> <li>• Use an HIM</li> <li>• Use a network connection</li> <li>• Or, set bit 5 'PERIF Flts' of parameter 1683 [Emerg Prot OVRD]</li> </ul>	Default: 0.00 Min/Max: 0.00/159999.15	RW	32-bit Integer
		1681	<b>Emerg OVRD Mode</b> Emergency Override Mode Selection Enter a value to select the emergency override mode "Disabled" (0) - disables emergency override. Normal protections are in force. "Only OVRD" (1) - Enables emergency override, with no change to position, velocity, or torque operation. "Purge Freq" (2) - Enables emergency override and the drive uses the value in parameter 1682 [Purge Frequency] for its velocity reference.	Default: 0 = "Disabled" Options: 0 = "Disabled" 1 = "Only OVRD" 2 = "Purge Freq"	RW	32-bit Integer
		1682	<b>Purge Frequency</b> Purge Frequency Enter a value to set the speed reference while emergency override is enabled in purge frequency mode.	Units: HZ or RPM Default: 5 Min/Max: -35400/+35400	RW	Real
		1683	<b>Emerg Prot OVRD</b> Emergency Protection Override Enter a value to configure the classes of faults for which the drive (or bus supply) to be bypassed when emergency override is enabled. See <a href="#">Table 10</a> , Drive Fault and Alarm Types, Descriptions, and Actions, for faults that apply to these classes. The following table defines bits and the related events overridden by the function when the bit is set on a PowerFlex 755 or a PowerFlex 753.		RW	32-bit Integer

Options	Reserved	Reserved	Reserved	Reserved	Reserved	Reserved	Reserved	Reserved	Reserved	Reserved	Reserved	Reserved	Reserved	Reserved	Port 9 Flts	Port 8 Flts	Port 7 Flts	Port 6 Flts	Port 5 Flts	Port 4 Flts	Port1-3 Flts	TorqPrv Flts	Fdbk Faults	Board Faults	DevLogixFlts	ENET PrtFlts	PERIF Flts	Reserved	Reserved	PwrStrucFlts	Line Faults	Load Faults
Default															0	0	0	0	0	0	0	0	0	0	0	0	0	0	0	0	0	0
Bit	31	30	29	28	27	26	25	24	23	22	21	20	19	18	17	16	15	14	13	12	11	10	9	8	7	6	5	4	3	2	1	0

0 = False  
1 = True

Bit 0 Load Faults  
Setting this bit overrides these load or motor related exception events: Motor Overload, Ground Warning, Load Loss, Output Phase Loss, Decel Inhibit, OverSpeed Limit, Excessive Load, Shear Pin 1, Shear Pin 2, IPM OverCurrent, SW OverCurrent, OutCurShare PhU, OutCurShare PhV, OutCurShare PhW.

Bit 1 Line Faults  
Setting this bit overrides these line or input power exception events: Power Loss Fault, UnderVoltage, Input Phase Loss, Ext Precharge Err.

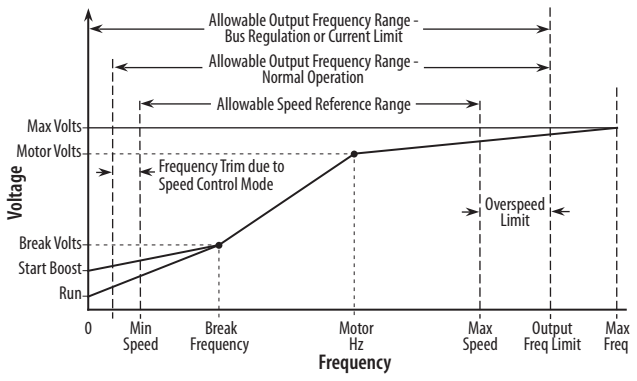
Bit 2 PwrStrucFlts  
Setting this bit overrides these power structure exception events: Overvoltage, Heat Sink Overtemp, Trstr Overtemp, Drive Overload, DC Bus Mismatch, HS Temp Imbal U, HS Temp Imbal V, HS Temp Imbal W, Heat Sink Undertemp.

Bit 3 Not Used  
Bit 4 Not Used

File	Group	No.	Display Name Full Name Description	Values	Read-Write	Data Type																																																									
PROTECTION	Emergency Ovrdr		Bit 5 PERIF Flts Setting this bit overrides these peripheral exception events: Aux Input, Dyn Brake Overtemp, No Stop Source. Bit 6 ENET PrtFlts Setting this bit overrides these EtherNet port exception events: Port 13 Adapter, Port 13 comm Loss, Port 13 Cfg, Port 13 Checksum, ENET Checksum, All Port 13 faults. Bit 7 DevLogixFlts Setting this bit overrides these DeviceLogix exception events: Port 14 Adapter, Port 14 comm Loss, Port 14 Cfg, Port 14 Checksum, DLX Checksum. Bit 8 Board Faults Setting this bit overrides these miscellaneous board exception events: Motor PTC Trip, Analog In Loss, Anlg Cal Chksum, Cntrl Bd Overtemp. Bit 9 Fdbk Faults Setting this bit overrides these speed and position feedback exception events: Pri VelFdbk Loss, Alt VelFdbk Loss, Aux VelFdbk Loss, Position Fdbk Loss, PM FV Flt Fdbk. Bit 10 TorqPrv Flts Setting this bit overrides these TorqueProve exception events: TorqPrv Spd Band, Brake Slipped, Torq Prove Conflict, TP Encls Config. Bit 11 Port1...3 Flts Setting this bit overrides these DPI port 1...3 communication exception events: Port 1 DPI Loss, Port 2 DPI Loss, Port 3 DPI Loss, Port 1 Adapter, Port 2 Adapter, Port 3 Adapter. Bit 12 Port 4 Flts Setting this bit overrides these DPI port 4 communication exception events: Port 4 DPI Loss, Port 4 Adapter, Port 4 comm Loss, Port 4 Checksum, Port 4 Cfg. Bit 13 Port 5 Flts Setting this bit overrides these DPI port 5 communication exception events: Port 5 DPI Loss, Port 5 Adapter, Port 5 comm Loss, Port 5 Checksum, Port 5 Cfg. Bit 14 Port 6 Flts Setting this bit overrides these DPI port 6 communication exception events: Port 6 DPI Loss, Port 6 Adapter, Port 6 comm Loss, Port 6 Checksum, Port 6 Cfg. Bit 15 Port 7 Flts Setting this bit overrides these DPI port 7 communication exception events: Port 7 DPI Loss, Port 7 Adapter, Port 7 comm Loss, Port 7 Checksum, Port 7 Cfg. Bit 16 Port 8 Flts Setting this bit overrides these DPI port 8 communication exception events: Port 8 DPI Loss, Port 8 Adapter, Port 8 comm Loss, Port 8 Checksum, Port 8 Cfg. Bit 17 Port 9 Flts Setting this bit overrides these DPI port 9 communication exception events: Port 9 DPI Loss, Port 9 Adapter, Port 9 comm Loss, Port 9 Checksum, Port 9 Cfg. Bit 18...Bit 31 Not used																																																												
		1684	<b>EmergMode Status</b> Emergency Mode Status Displays the status of emergency override: Bit 0 "Emergency" is set when emergency override is enabled and cleared when emergency override is disabled.		RO	16-bit Integer																																																									
			The following table defbits and the related events overridden by the function when the bit is set on a PowerFlex 755 or a PowerFlex 753.																																																												
			<table border="1"> <thead> <tr> <th>Options</th> <th>Reserved</th> <th>Reserved</th> <th>Reserved</th> <th>Reserved</th> <th>Reserved</th> <th>Reserved</th> <th>Reserved</th> <th>Reserved</th> <th>Reserved</th> <th>Reserved</th> <th>Reserved</th> <th>Reserved</th> <th>Reserved</th> <th>Reserved</th> <th>Reserved</th> <th>Reserved</th> <th>Reserved</th> <th>Override</th> </tr> </thead> <tbody> <tr> <td>Default</td> <td>0</td> <td>0</td> <td>0</td> <td>0</td> <td>0</td> <td>0</td> <td>0</td> <td>0</td> <td>0</td> <td>0</td> <td>0</td> <td>0</td> <td>0</td> <td>0</td> <td>0</td> <td>0</td> <td>0</td> <td>0</td> </tr> <tr> <td>Bit</td> <td>15</td> <td>14</td> <td>13</td> <td>12</td> <td>11</td> <td>10</td> <td>9</td> <td>8</td> <td>7</td> <td>6</td> <td>5</td> <td>4</td> <td>3</td> <td>2</td> <td>1</td> <td>0</td> <td></td> <td></td> </tr> </tbody> </table>	Options	Reserved	Reserved	Reserved	Reserved	Reserved	Reserved	Reserved	Reserved	Reserved	Reserved	Reserved	Reserved	Reserved	Reserved	Reserved	Reserved	Reserved	Override	Default	0	0	0	0	0	0	0	0	0	0	0	0	0	0	0	0	0	0	Bit	15	14	13	12	11	10	9	8	7	6	5	4	3	2	1	0				0 = Normal 1 = Override	
Options	Reserved	Reserved	Reserved	Reserved	Reserved	Reserved	Reserved	Reserved	Reserved	Reserved	Reserved	Reserved	Reserved	Reserved	Reserved	Reserved	Reserved	Override																																													
Default	0	0	0	0	0	0	0	0	0	0	0	0	0	0	0	0	0	0																																													
Bit	15	14	13	12	11	10	9	8	7	6	5	4	3	2	1	0																																															


# Drive (Port 0) Speed Control File



File	Group	No.	Display Name Full Name Description	Values	Read-Write	Data Type
SPEED CONTROL	Speed Limits	520	<b>Max Fwd Speed</b> Maximum Forward Speed Sets the forward speed high limit. Refer to P524 [Overspeed Limit].	Units: Hz RPM Default: P27 [Motor NP Hertz] P28 [Motor NP RPM] Min/Max: 650 / P27 [Motor NP Hertz] 78000 / P28 [Motor NP RPM] x P31 [Motor Poles]	RW	Real
		521	<b>Max Rev Speed</b> Maximum Reverse Speed Sets the reverse speed high limit. Refer to P524 [Overspeed Limit].	Units: Hz RPM Default: P27 [Motor NP Hertz] x -1.00 P28 [Motor NP RPM] x -1.00 Min/Max: -650 / P27 [Motor NP Hertz] -78000 / P28 [Motor NP RPM] x P31 [Motor Poles]	RW	Real
		522	<b>Min Fwd Speed</b> Minimum Forward Speed Sets the low limit for speed reference after scaling is applied. Refer to P524 [Overspeed Limit].	Units: Hz RPM Default: 0.00 Min/Max: 650 / P27 [Motor NP Hertz] 78000 / P28 [Motor NP RPM] x P31 [Motor Poles]	RW	Real
		523	<b>Min Rev Speed</b> Minimum Reverse Speed Sets the low limit for speed reference after scaling is applied. Refer to P524 [Overspeed Limit].	Units: Hz RPM Default: 0.00 Min/Max: -650 / P27 [Motor NP Hertz] -78000 / P28 [Motor NP RPM] x P31 [Motor Poles]	RW	Real
		524	<b>Overspeed Limit</b> Overspeed Limit Sets the incremental amount of the output frequency (above maximum speed; either P520 [Max Fwd Speed] or P521 [Max Rev Speed]) allowable for functions such as slip compensation.	Units: Hz RPM Default: Based on P27 [Motor NP Hertz]/P28 [Motor NP RPM] and Voltage Class Min/Max: 0.00 / P27 [Motor NP Hertz] 0.00 / (P28 [Motor NP RPM] / 3)	RW	Real
		525	<b>Zero Speed Limit</b> Zero Speed Limit Establishes a band around zero speed that is used to determine when the drive considers the motor to be at zero speed.	Units: Hz RPM Default: P27 [Motor NP Hertz] x 0.001 P28 [Motor NP RPM] x 0.001 Min/Max: Based on P27 [Motor NP Hertz]/P28 [Motor NP RPM] and Voltage Class	RW	Real



File	Group	No.	Display Name Full Name Description	Values	Read-Write	Data Type
SPEED CONTROL	Speed Limits	526	<b>Skip Speed 1</b>	Units: Hz RPM Default: 0.00 Min/Max: P521 [Max Rev Speed] / P520 [Max Fwd Speed]	RW	Real
		527	<b>Skip Speed 2</b>			
528	<b>Skip Speed 3</b> Skip Speed <i>n</i> Sets a frequency at which the drive will not operate. Parameters are disabled if set to 0.					
		529	<b>Skip Speed Band</b> Skip Speed Band Sets the bandwidth around a skip speed. [Skip Speed Band] is split, applying 1/2 above and 1/2 below the skip speed. The same bandwidth applies to all skip speeds. Parameter is disabled if set to 0.	Units: Hz RPM Default: 0.00 Min/Max: 0.00 / Based on P27 [Motor NP Hertz]/P28 [Motor NP RPM] and Voltage Class	RW	Real

File	Group	No.	Name Description	Values	Read-Write	Data Type
SPEED CONTROL	Speed Ramp Rates	535	<b>Accel Time 1</b>	Units: Secs Default: 10.00 Min/Max: 0.00 / 3600.00	RW	Real
		536	<b>Accel Time 2</b> Acceleration Time <i>n</i> Sets the acceleration rate for all speed changes. Defined as the time to accelerate from 0 to P27 [Motor NP Hertz] or P28 [Motor NP RPM], according to the setting in P300 [Speed Units]. Selection between Acceleration Time 1 and Acceleration Time 2 is controlled by a digital input function (see Digin Functions) or by Logic Command (sent over a communication network or DeviceLogix).			
		537	<b>Decel Time 1</b>	Units: Secs Default: 10.00 Min/Max: 0.00 / 3600.00	RW	Real
		538	<b>Decel Time 2</b> Deceleration Time <i>n</i> Sets the deceleration rate for all speed changes. Defined as the time to decelerate from P27 [Motor NP Hertz] or P28 [Motor NP RPM] to 0, according to the setting in P300 [Speed Units]. Selection between Deceleration Time 1 and Deceleration Time 2 is controlled by a digital input function (see Digin Functions) or by Logic Command (sent over a communication network or DeviceLogix). Some stop modes (see P370 and P371) will cause the programmed decel time to be ignored during a stop command.			
		539	<b>Jog Acc Dec Time</b> Jog Acceleration Deceleration Time Acceleration and deceleration rates while commanding jog (uses a jog speed reference).	Units: Secs Default: 10.00 Min/Max: 0.00 / 3600.00	RW	Real
540	<b>S Curve Accel</b> S Curve Acceleration Sets the percentage of accel time applied to the ramp to soften (reduce jerk) the acceleration. Time is added, 1/2 at the beginning and 1/2 at the end of the ramp.	Units: % Default: 0.000 Min/Max: 0.000 / 100.000	RW	Real		
		541	<b>S Curve Decel</b> S Curve Deceleration Sets the percentage of decel time applied to the ramp to soften (reduce jerk) the deceleration. Time is added, 1/2 at the beginning and 1/2 at the end of the ramp.	Units: % Default: 0.000 Min/Max: 0.000 / 100.000	RW	Real

File	Group	No.	Display Name Full Name Description	Values	Read-Write	Data Type
SPEED CONTROL	Speed Reference	545	<b>Spd Ref A Sel</b>	Default: 871 551 Min/Max: 0 / 159999	RW	32-bit Integer
		550	<b>Spd Ref B Sel</b>  Speed Reference A, B Select Selects the source for speed references while in "Auto" (typical) mode. When the drive is in "Manual" mode, these sources are overridden (see P327). [Spd Ref A Sel] is the drive's main speed reference. [Spd Ref B Sel] is an alternate speed reference. Selecting between Reference A and Reference B is controlled by a digital input function (see parameters 173...175 [DI Speed Sel <i>n</i> ]) or by Logic Command bits 12...14 (sent over a communication network). When the speed reference is from a communication network, set this parameter to Port 0 and select parameter 874...877 [Port <i>n</i> Reference] as appropriate. If the speed reference is from an encoder, set this parameter to Port 0 and select parameter 134 [Aux Vel Feedback]. Configure parameter 132 [Aux Vel Fdbk Sel] to the appropriate encoder. To access these parameters, set P301 [Access Level] to option 2 "Expert."			
		546	<b>Spd Ref A Stpt</b>	Units: Hz RPM Default: 0.0000 Hz Min/Max: -/+P27 [Motor NP Hertz] x 8 -/+P28 [Motor NP RPM] x 8	RW	Real
		551	<b>Spd Ref B Stpt</b> Speed Reference A, B Setpoint A constant speed value (similar to a preset speed) to be used as a possible source for P545 and P550.			
		547	<b>Spd Ref A AnlgHi</b>	Units: Hz Default: P520 [Max Fwd Speed] Min/Max: P521 [Max Rev Speed] / P520 [Max Fwd Speed]	RW	Real
		552	<b>Spd Ref B AnlgHi</b> Speed Reference A, B Analog High Used only when an analog input is selected as a speed reference according to P545/550 [Spd Ref <i>n</i> Sel]. Sets the speed that corresponds to P51/61 [Anlg Inn Hi] on an I/O module. This establishes scaling throughout the range.			
		548	<b>Spd Ref A AnlgLo</b>	Units: Hz Default: 0.00 Min/Max: P521 [Max Rev Speed] / P520 [Max Fwd Speed]	RW	Real
		553	<b>Spd Ref B AnlgLo</b> Speed Reference A, B Analog Low Used only when an analog input is selected as a speed reference according to P545/550 [Spd Ref <i>n</i> Sel]. Sets the speed that corresponds to P51/61 [Anlg Inn Lo] on an I/O module. This establishes scaling throughout the range.			
		549	<b>Spd Ref A Mult</b>	Default: 1.00 Min/Max: -/+22000.00	RW	Real
		554	<b>Spd Ref B Mult</b> Speed Reference A, B Multiplier Applies multipliers to speed references A and B respectively.			
555	<b>Spd Ref Scale</b> Speed Reference Scale Applies only in Flux Vector (FV) modes according to P35 [Motor Ctrl Mode]. Applies a multiplier to P595 [Filtered Spd Ref] after it has been offset by the PID function (P1093 [PID Output Meter]). The scaled result, once limited, will become the primary component of the value of P597 [Final Speed Ref].	Default: 1.000 Min/Max: 0.000 / 1000.000	RW	Real		
556	<b>Jog Speed 1</b>	Units: Hz Default: Based on P27 [Motor NP Hertz]/P28 [Motor NP RPM] and Voltage Class Min/Max: -/+P27 [Motor NP Hertz] x 8 -/+P28 [Motor NP RPM] x 8	RW	Real		
557	<b>Jog Speed 2</b> Jog Speed <i>n</i> The speed used for jogging when the Jog 1 or Jog 2 function (respectively) is activated by a digital input function or by Logic Command (sent over a communication network).					
558	<b>MOP Reference</b> Motor Operated Potentiometer Reference Value of the MOP (Motor Operated Potentiometer) Reference to be used as a possible source for P545/550 [Spd Ref <i>n</i> Sel]. The MOP Reference is activated (incremented or decremented) by digital input functions.	Units: % Default: 0.00 Min/Max: -/+800.00	RO	Real		


File	Group	No.	Display Name Full Name Description	Values	Read-Write	Data Type																																																			
SPEED CONTROL	Speed Reference	559	<b>Save MOP Ref</b> Save Motor Operated Potentiometer Reference Enables/disables the feature that saves the present MOP Ref value at power down or stop.  Options <table border="1"> <tr> <td></td> <td>Reserved</td><td>Reserved</td><td>Reserved</td><td>Reserved</td><td>Reserved</td><td>Reserved</td><td>Reserved</td><td>Reserved</td><td>Reserved</td><td>Reserved</td><td>Reserved</td><td>Reserved</td><td>Reserved</td><td>Reserved</td><td>At Stop</td><td>At Pwr Down</td> </tr> <tr> <td>Default</td> <td>0</td><td>0</td><td>0</td><td>0</td><td>0</td><td>0</td><td>0</td><td>0</td><td>0</td><td>0</td><td>0</td><td>0</td><td>0</td><td>0</td><td>0</td><td>0</td> </tr> <tr> <td>Bit</td> <td>15</td><td>14</td><td>13</td><td>12</td><td>11</td><td>10</td><td>9</td><td>8</td><td>7</td><td>6</td><td>5</td><td>4</td><td>3</td><td>2</td><td>1</td><td>0</td> </tr> </table> 0 = False 1 = True		Reserved	Reserved	Reserved	Reserved	Reserved	Reserved	Reserved	Reserved	Reserved	Reserved	Reserved	Reserved	Reserved	Reserved	At Stop	At Pwr Down	Default	0	0	0	0	0	0	0	0	0	0	0	0	0	0	0	0	Bit	15	14	13	12	11	10	9	8	7	6	5	4	3	2	1	0		RW	16-bit Integer
			Reserved	Reserved	Reserved	Reserved	Reserved	Reserved	Reserved	Reserved	Reserved	Reserved	Reserved	Reserved	Reserved	Reserved	At Stop	At Pwr Down																																							
		Default	0	0	0	0	0	0	0	0	0	0	0	0	0	0	0	0																																							
		Bit	15	14	13	12	11	10	9	8	7	6	5	4	3	2	1	0																																							
		560	<b>MOP Rate</b> Motor Operated Potentiometer Rate Sets the rate of change of the MOP reference when an increasing or decreasing MOP signal is present.	Units: %/s Default: 1.0000 Min/Max: 0.0100 / 100.0000	RW	Real																																																			
		561	<b>MOP High Limit</b> Motor Operated Potentiometer High Limit Sets the upper limit for the MOP Reference.	Units: % Default: 100.000 Min/Max: 0.000 / 800.000	RW	Real																																																			
		562	<b>MOP Low Limit</b> Motor Operated Potentiometer Low Limit Sets the lower limit for the MOP Reference.	Units: % Default: -100.000 Min/Max: -800.000 / 0.000	RW	Real																																																			
		563	<b>DI ManRef Sel</b>  Digital Input Manual Reference Select Selects a speed reference to be used when a digital input activates Manual control, according to the operation described by P172 [DI Manual Ctrl].	Default: 872 Min/Max: 1 / 159999	RW	32-bit Integer																																																			
		564	<b>DI ManRef AnlgHi</b> Digital Input Manual Reference Analog High High scale for the manual speed reference that is activated by a digital input when P563 [DI ManRef Sel] is connected to an Analog Input.	Units: Hz RPM Default: P520 [Max Fwd Speed] Min/Max: P521 [Max Rev Speed] / P520 [Max Fwd Speed]	RW	Real																																																			
		565	<b>DI ManRef AnlgLo</b> Digital Input Manual Reference Analog Low Used only when P563 [DI ManRef Sel] has selected an analog input as the source of the speed reference. Specifies the speed reference value that will be associated with the Analog In Lo parameter for the I/O Module. Example, P563 [DI ManRef Sel] has selected P50 [Anlg In0 Value] on an I/O Module. The P51 [Anlg In0 Hi] parameter on the I/O Module is set to -10 volts. P564 [DI ManRef AnlgHi] will specify the speed reference value that will correspond with a -10 volt analog input signal.	Units: Hz RPM Default: 0.000 Min/Max: P521 [Max Rev Speed] / P520 [Max Fwd Speed]	RW	Real																																																			
566	<b>MOP Init Select</b>  Motor Operated Potentiometer Initialization Select Defines the initial MOP value when the MOP is not configured to start at the "At Power Down" or "At Stop" values selected in P559 [Save MOP Ref].	Default: 567 Min/Max: 0 / 159999	RW	32-bit Integer																																																					
567	<b>MOP Init Stpt</b> Motor Operated Potentiometer Initialization Setpoint A configurable set point to be used with the MOP initialization function.	Units: % Default: 0 Min/Max: -/+8.00	RW	Real																																																					
571	<b>Preset Speed 1</b>	Units: Hz RPM Default: Based on P27 [Motor NP Hertz]/P28 [Motor NP RPM] and Voltage Class Min/Max: P521 [Max Rev Speed] / P520 [Max Fwd Speed]	RW	Real																																																					
572	<b>Preset Speed 2</b>																																																								
573	<b>Preset Speed 3</b>																																																								
574	<b>Preset Speed 4</b>																																																								
575	<b>Preset Speed 5</b>																																																								
576	<b>Preset Speed 6</b>																																																								
577	<b>Preset Speed 7</b> Preset Speed <i>n</i> Discrete speed references that are activated by a digital input function (see Digin Functions) or by Logic Command (sent over a communication network or DeviceLogix).																																																								




File	Group	No.	Display Name Full Name Description	Values	Read-Write	Data Type
SPEED CONTROL	Speed Reference	588	<b>Spd Ref Filter</b> Speed Reference Filter Selects the amount of filtering applied to the ramped speed reference (P594), and is only active in FV motor control modes (P35). When set to any of the custom settings (3, 4, or 5) the filter is configured using the values set in P589 [Spd Ref Fltr BW] and P590 [Spd Ref FltrGain]. Settings 4 and 5 initialize the values for light and heavy respectively.	Default: 0 = "Off" Options: 0 = "Off" 1 = "Light" 2 = "Heavy" 3 = "Custom" 4 = "SetCustLight" 5 = "SetCustHeavy"	RW	32-bit Integer
		589	<b>Spd Ref Fltr BW</b> Speed Reference Filter Bandwidth Sets the bandwidth of the speed reference filter when P588 [Spd Ref Filter] is set to one of the "Custom" settings (3, 4, or 5) A value of zero will disable (bypass) the filter.	Units: R/S Default: 0.00 Min/Max: 0.00 / 500.00	RW	Real
		590	<b>Spd Ref FltrGain</b> Speed Reference Filter Gain Sets the gain (kn) of the speed reference filter when P588 [Spd Ref Filter] is set to one of the "Custom" settings (3, 4, or 5). A gain value of zero results in a filter characteristic that behaves as a first order low pass. A gain value ranging between zero and one results in a lag type filter. A gain value greater than one results in a lead type filter. A gain value of one will disable (bypass) the filter. This is the default setting. This parameter has no units.	Default: 1.000 Min/Max: -/+5.000	RW	Real

File	Group	No.	Display Name Full Name Description	Values	Read-Write	Data Type																												
SPEED CONTROL	Speed Reference	591	<b>Spd Ref Sel Sts</b> Speed Reference Select Status		RO	32-bit Integer																												
		Options																																
		Reserved	Reserved	Reserved	Reserved	Reserved	Reserved	Reserved	Reserved	Reserved	Reserved	Reserved	Reserved	Reserved	Reserved	Reserved	Skip Band	End Lmt Sw	Decel Lmt Sw	Unipolar Ref	Rev Disable	Bipolar Ref	Sel Override	Manual	Preset Auto	Trim Ref	Trim Pct Ref	MicroPsnMult	RefB Mult	RefA Mult	RefB Auto	RefA Auto		
		Default	0	0	0	0	0	0	0	0	0	0	0	0	0	0	0	0	0	0	0	0	0	0	0	0	0	0	0	0	0	0		
		Bit	31	30	29	28	27	26	25	24	23	22	21	20	19	18	17	16	15	14	13	12	11	10	9	8	7	6	5	4	3	2	1	0
								0 = False 1 = True																										
		<p>Displays the operating status of the speed referencing section of the drive. Individual bits are provided to represent the following conditions:</p> <p>Bit 0 "Ref A Auto" – When set, the Reference A Auto path is active. Control Logic has selected the Speed Reference source A. The exact origin of this speed reference is determined by the parameter specified in P545 [Spd Ref A Sel]. This parameter should also be reported in P930 [Speed Ref Source].</p> <p>Bit 1 "Ref B Auto" – When set, the Reference B Auto path is active. Control Logic has selected the Speed Reference source B. The exact origin of this speed reference is determined by the value specified in P550 [Spd Ref B Sel]. This parameter should also be reported in P930 [Speed Ref Source].</p> <p>Bit 2 "Ref A Mult" – When set, speed reference A is being modified by P549 [Spd Ref A Mult]. When clear, either the multiplier is 1 or is not affecting the speed reference because the Ref A Auto path is inactive.</p> <p>Bit 3 "Ref B Mult" – When set, the speed reference B is being modified by P554 [Spd Ref B Mult]. When clear, either the multiplier is 1 or is not affecting the speed reference because the "Ref B Auto" path is inactive.</p> <p>Bit 4 "MicroPsnMult" – When set, P592 [Selected Spd Ref] is being multiplied by P1112 [MicroPsnScalePct].</p> <p>Bit 5 "Trim Pct Ref" – When set, the speed reference is summed with a portion of the reference that results from multiplying the reference by the value of the parameter indicated in P616 [SpdTrimPrcRefSrc].</p> <p>Bit 6 "Trim Ref" – When set, the speed reference is being offset by the value of the parameter indicated in P617 [Spd Trim Source].</p> <p>Bit 7 "Preset Auto" – When set, Control Logic has selected a preset auto speed reference. The P930 [Speed Ref Source] parameter will indicate the source of this reference.</p> <p>Bit 8 "Manual" – When set, the speed reference selection is in one of the Manual positions due to P879 [Drive Logic Rslt] Bit 6 "Manual" being set. When P879, Bit 6 is clear, the speed reference selection is in one of the Auto positions. The result of the Auto/Manual speed reference selection can be seen in P592 [Selected Spd Ref].</p> <p>Bit 9 "Sel Override" – The Selected Speed Reference parameter has been overridden by another reference. Refer to P930 [Speed Ref Source] for the cause of the override.</p> <p>Bit 10 "Bipolar Ref" – When set, P308 [Direction Mode] = 1 "Bipolar." When in bipolar mode, the sign of the speed reference value will determine the direction of motor rotation.</p> <p>Bit 11 "Rev Disable" – When set, P308 [Direction Mode] = 2 "Rev Disable." When in reverse disable mode, negative speed reference values are rejected and a zero speed value is used in their place.</p> <p>Bit 12 "Unipolar Ref" – When set, P308 [Direction Mode] = 0 "Unipolar." When in unipolar mode, the sign of the speed reference value (and therefore direction of motor rotation) is determined by P879 [Drive Logic Rslt] Bit 4 "Forward" and Bit 5 "Reverse."</p> <p>Bit 13 "Decel Lmt Sw" – When set, the Torque Proving function's control logic has detected a decel limit switch active and has selected P571 [Preset Speed 1] for the speed reference value.</p> <p>Bit 14 "End Lim Sw" – When set, the Torque Proving function's control logic has detected an end limit switch active and has selected zero speed for the speed reference value.</p> <p>Bit 15 "Skip Band" – When set, the Skip Band function has modified P2 [Commanded SpdRef]. When clear, the Skip Band function has not changed P2 [Commanded SpdRef].</p>																																

File	Group	No.	Display Name Full Name Description	Values		Read-Write	Data Type
SPEED CONTROL	Speed Reference	592	<b>Selected Spd Ref</b> Selected Speed Reference Displays the value of the active speed reference.	Units: Hz RPM Default: 0.00 Min/Max: -/+P27 [Motor NP Hertz] -/+P28 [Motor NP RPM]		RO	Real
		593	<b>Limited Spd Ref</b> Limited Speed Reference Displays the value of the speed reference after the following limits have been applied: P520 [Max Fwd Speed], P521 [Max Rev Speed], P522 [Min Fwd Speed] and P523 [Min Rev Speed].	Units: Hz RPM Default: 0.00 Min/Max: -/+P27 [Motor NP Hertz] -/+P28 [Motor NP RPM]		RO	Real
		594	<b>Ramped Spd Ref</b> Ramped Speed Reference Displays the output of the speed reference ramp and S-curve functions, but prior to any corrections added by slip comp, PI, etc.	Units: Hz RPM Default: 0.00 Min/Max: -/+P27 [Motor NP Hertz] -/+P28 [Motor NP RPM]		RO	Real
		595	<b>Filtered Spd Ref</b> Filtered Speed Reference Displays the output of the filter that is applied by P588 [Spd Ref Filter].	Units: Hz RPM Default: 0.00 Min/Max: -/+P27 [Motor NP Hertz] -/+P28 [Motor NP RPM]		RO	Real
		596	<b>Speed Rate Ref</b> Speed Rate Reference This parameter is shared by both the Inertia Compensation and Speed Compensation functions. These functions are only available in the Flux Vector selections for P35 [Motor Ctrl Mode]. A value shared by both the Inertia Compensation and Speed Compensation functions (active only in FV motor control modes), typically supplied by an external controller that is also providing a rate limited speed reference. The Speed Rate Reference corresponds to the derivative with respect to time of the speed reference signal. Units of time are in seconds. For example, if the controller provides a 10 second reference ramp, the controller would also supply a Speed Rate Ref value of 1 pu / 10 sec = 0.1 sec <sup>-1</sup> while the reference is accelerating. When the reference is constant, Speed Rate Ref should be zero.	Units: Hz RPM Default: 0.00 Min/Max: -/+P27 [Motor NP Hertz] -/+P28 [Motor NP RPM]		RW	Real
		597	<b>Final Speed Ref</b> Final Speed Reference Displays the speed reference value, after all reference modifications (including ramps), that is used as a final reference by the speed regulator. In Open Loop, Sensorless Vector mode, this value represents the anticipated motor operating speed, and may differ slightly from the output frequency value due to slip compensation.	Units: Hz RPM Default: 0.00 Min/Max: -/+P27 [Motor NP Hertz] -/+P28 [Motor NP RPM]		RO	Real

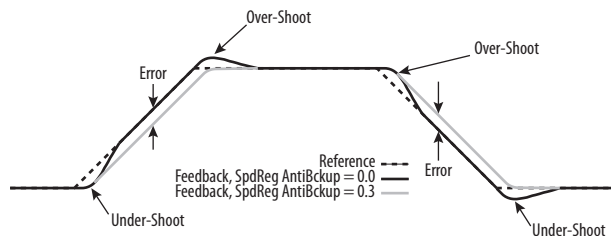
File	Group	No.	Display Name Full Name Description	Values		Read-Write	Data Type
SPEED CONTROL	Speed Trim	600 604	<b>Trim Ref A Sel</b> <b>Trim Ref B Sel</b>  Trim Reference A, B Select Selects a trim source (in Hz or RPM) for Speed Reference A or Speed Reference B, respectively. For trim in % instead of Hz or RPM, use P608/612 (TrimPct Refn Sel).	Default: P601 [Trim Ref A Sel] P605 [Trim Ref B Stpt] Min/Max: 0 / 159999		RW	32-bit Integer
		601 605	<b>Trim Ref A Stpt</b> <b>Trim Ref B Stpt</b> Trim Reference A, B Setpoint A digital value to be used as a possible trim source for P600 or P604, respectively	Units: Hz RPM Default: 0.00 Min/Max: -/+P27 [Motor NP Hertz] -/+P28 [Motor NP RPM] x 8		RW	Real

File	Group	No.	Display Name	Values		Read-Write	Data Type
			Full Name Description				
SPEED CONTROL	Speed Trim	602 606	<b>Trim RefA AnlgHi</b> <b>Trim RefB AnlgHi</b> Trim Reference A, B Analog High Used only when an analog input is selected as a trim source according to P600 or P604. Sets the amount of trim that corresponds to P51/61 [Anlg In $n$ Hi] on an I/O module or on the main control (product dependent). This establishes scaling throughout the range.	Units: Hz RPM Default: P520 [Max Fwd Speed] Min/Max: P521 [Max Rev Speed] / P520 [Max Fwd Speed]		RW	Real
		603 607	<b>Trim RefA AnlgLo</b> <b>Trim RefB AnlgLo</b> Trim Reference A, B Analog Low Used only when an analog input is selected as a trim source according to P600/604 [Trim Ref $n$ Sel]. Sets the amount of trim that corresponds to P52/62 [Anlg In $n$ Lo] on an I/O module or on the main control (product dependent). This establishes scaling throughout the range.	Units: Hz RPM Default: 0.00 Min/Max: P521 [Max Rev Speed] / P520 [Max Fwd Speed]		RW	Real
		608 612	<b>TrmPct RefA Sel</b> <b>TrmPct RefB Sel</b>  Trim Percent Reference A, B Select Selects a trim source (in %) for Speed Reference A or Speed Reference B, respectively. For trim in Hz or RPM instead of %, use P600/604 [Trim Ref $n$ Sel].	Default: P609 [TrmPct RefA Stpt] P613 [TrmPct RefB Stpt] Min/Max: 0 / 159999		RW	32-bit Integer
		609 613	<b>TrmPct RefA Stpt</b> <b>TrmPct RefB Stpt</b> Trim Percent Reference A, B Setpoint A digital value to be used as a possible trim source for P608 or P612, respectively.	Units: % Default: 0.000 Min/Max: -/+800.000		RW	Real
		610 614	<b>TrmPct RefA AnHi</b> <b>TrmPct RefB AnHi</b> Trim Percent Reference A, B Analog High Used only when an analog input is selected as a percent trim source according to P608 or P612. Sets the amount of trim that corresponds to P51/61 [Anlg In $n$ Hi] on an I/O module or on the main control (product dependent). This establishes scaling throughout the range.	Units: % Default: 100.00 Min/Max: -/+800.00		RW	Real
		611 615	<b>TrmPct RefA AnLo</b> <b>TrmPct RefB AnLo</b> Trim Percent Reference A, B Analog Low Used only when an analog input is selected as a percent trim source according to P608 or P612. Sets the amount of trim that corresponds to P52/62 [Anlg In $n$ Lo] on an I/O module or on the main control (product dependent). This establishes scaling throughout the range.	Units: % Default: 0.00 Min/Max: -/+800.00		RW	Real
		616	<b>SpdTrimPrcRefSrc</b> Speed Trim Percent Reference Source Displays the source of Motor Speed Reference Trim Percent, in the format SSPPPP, where SS indicates the source port number other than Port 0 and PPPP indicates the source parameter number. A value of zero indicates that a source has not been assigned.	Default: 0 Min/Max: 0 / 159999		RO	32-bit Integer
		617	<b>Spd Trim Source</b> Speed Trim Source Displays the source of Motor Speed Reference Trim, in the format SSPPPP, where SS indicates the source port number other than Port 0 and PPPP indicates the source parameter number. A value of zero indicates that a source has not been assigned.	Default: 0 Min/Max: 0 / 159999		RO	32-bit Integer

File	Group	No.	Display Name Full Name Description	Values		Read-Write	Data Type
				Units:			
SPEED CONTROL	Slip/Droop Comp	620	<b>Droop RPM at FLA</b> Droop Revolutions Per Minute at Full Load Amps Selects amount of droop that the speed reference is reduced when at full load torque. Zero disables the droop function.	Units: RPM Default: 0.00 Min/Max: 0.00 / 900.00		RW	Real
		621	<b>Slip RPM at FLA</b> Slip Revolutions Per Minute at Full Load Amps For open loop modes, this parameter sets the amount of slip (in rpm) that the motor is expected to experience at full load. A setting of zero disables slip compensation (not used in closed loop modes with encoder feedback). If the value of P70 [Autotune] is set to "Calculate", this value (in addition to others) is automatically calculated, and cannot be manually adjusted. This parameter cannot be changed unless P70 [Autotune] is set to 0 "Ready."	Units: RPM Default: (P27 [Motor NP Hz] x 120) / (P31 [Motor Poles] – P28 [Motor NP RPM]) Min/Max: 0.00 / 1200.00		RW	Real
		622	<b>Slip Comp BW</b> Slip Compensation Bandwidth Adjusts the bandwidth of a low pass filter used for slip compensation. The response time of slip compensation will vary inversely with the setting of this filter.	Units: R/S Default: 10.00 Min/Max: 1.00 / 50.00		RW	Real
		623	<b>VHzSV SpdTrimReg</b> Volts per Hertz Sensorless Vector Speed Trim Regulator Displays the amount of trim that the slip compensation function dynamically adds (based on load) to final speed reference for improved open loop speed control. Not used in Flux Vector (FV) modes.	Units: Hz RPM Default: 0.00 Min/Max: -/+P27 [Motor NP Hertz] x 8 -/+P28 [Motor NP RPM] x 8		RO	Real

File	Group	No.	Display Name Full Name Description	Values	Read-Write	Data Type																																																					
SPEED CONTROL	Speed Regulator	635	<b>Spd Options Ctrl</b> Speed Options Control  Options <table border="1" style="margin-left: 20px;"> <tr> <td></td> <td>Reserved</td> <td>Reserved</td> <td>Reserved</td> <td>Reserved</td> <td>Reserved</td> <td>Reserved</td> <td>Reserved</td> <td>Reserved</td> <td>Delayed Ref</td> <td>Auto Tach SW</td> <td>Jog No Integ</td> <td>SpdErrFilter</td> <td>SpdRegIntHld</td> <td>SpdRegIntRes</td> <td>StpNoScrvAcc</td> <td>Ramp Disable</td> <td>Ramp Hold</td> </tr> <tr> <td>Default</td> <td>0</td> <td>0</td> <td>0</td> <td>0</td> <td>0</td> <td>0</td> <td>0</td> <td>0</td> <td>0</td> <td>0</td> <td>0</td> <td>0</td> <td>0</td> <td>0</td> <td>0</td> <td>0</td> <td>0</td> </tr> <tr> <td>Bit</td> <td>15</td> <td>14</td> <td>13</td> <td>12</td> <td>11</td> <td>10</td> <td>9</td> <td>8</td> <td>7</td> <td>6</td> <td>5</td> <td>4</td> <td>3</td> <td>2</td> <td>1</td> <td>0</td> <td></td> </tr> </table> 0 = False 1 = True		Reserved	Reserved	Reserved	Reserved	Reserved	Reserved	Reserved	Reserved	Delayed Ref	Auto Tach SW	Jog No Integ	SpdErrFilter	SpdRegIntHld	SpdRegIntRes	StpNoScrvAcc	Ramp Disable	Ramp Hold	Default	0	0	0	0	0	0	0	0	0	0	0	0	0	0	0	0	0	Bit	15	14	13	12	11	10	9	8	7	6	5	4	3	2	1	0		RW	16-bit Integer
			Reserved	Reserved	Reserved	Reserved	Reserved	Reserved	Reserved	Reserved	Delayed Ref	Auto Tach SW	Jog No Integ	SpdErrFilter	SpdRegIntHld	SpdRegIntRes	StpNoScrvAcc	Ramp Disable	Ramp Hold																																								
Default	0	0	0	0	0	0	0	0	0	0	0	0	0	0	0	0	0																																										
Bit	15	14	13	12	11	10	9	8	7	6	5	4	3	2	1	0																																											
			Configures options related to Speed Control as follows: Bit 0 "Ramp Hold" – The output of the speed reference ramp will stop changing and hold its output constant while this bit is set. When this bit is clear, the ramp output will be allowed to change. If this bit becomes set while P594 [Ramped Spd Ref] is in the S Curve region, the S Curve will be allowed to complete before the output is held. Bit 1 "Ramp Disable" – When set, the speed reference ramp will be bypassed. P594 [Ramped Spd Ref] will track the ramp input. Bit 2 "StpNoScrvAcc" – There are some conditions where the drive may continue to accelerate briefly following a request to stop. This will occur if the drive was in the process of accelerating on an S Curve when the stop request occurred. This bit enables an option to discontinue acceleration immediately when the stop request occurs. The S Curve profile that was in process will then change to a linear decel ramp. Bit 3 "SpdRegIntRes" – When set, the P654 [Spd Reg Int Out] which is the output of the Vector mode speed regulator's integral term will be forced to zero. The same result can be achieved by setting the regulator's integral gain to zero. Bit 4 "SpdRegIntHld" – When set, the P654 [Spd Reg Int Out] which is the output of the Vector mode speed regulator's integral term will stop changing and be held constant. Other conditions in the drive such as a limit condition in P945 [At Limit Status] may have the same result. Bit 5 "SpdErrFilter" – When set, the speed error filter in the drive's Vector mode speed regulator will be configured for a single stage low pass filter. When clear, the error filter will be configured for a two stage low pass filter. The two stage configuration is the normal or default setting for the error filter. Bit 6 "Jog No Integ" – When set, the P654 [Spd Reg Int Out] which is the output of the Vector mode speed regulator's integral term will be forced to zero while jogging. Bit 7 "Auto Tach SW" – This bit is used to enable the Automatic Tach Switchover feature. This feature is used to switch motor velocity feedback sources from the Primary (P125) to Alternate (P128) source in the event that the primary source fails. This switchover can take place while the drive is running. The P936 [Drive Status 2] Bit 5 "FdbkLoss Sw0" will indicate clear when the Primary source is active and set when the alternate source is active. <ul style="list-style-type: none"> <li>When using the Automatic Tach Switchover feature, the Feedback Loss Configuration parameter on the feedback module should be set to something other than fault.</li> <li>When using induction motors, clearing this bit when the alternate source is active will restore control to the Primary source, provided that the primary source is functioning.</li> <li>When using permanent magnet motors, cycling power to the drive will restore control to the Primary source, provided that the primary source is functioning. If this bit remains off, then the Automatic Tach Switchover feature will be disabled.</li> </ul> <b>Important:</b> The Primary feedback source uses the P126 [Pri Vel FdbkFltr] filter setting and tuning gains set in P636 [Speed Reg BW], P645 [Speed Reg Kp], and P647 [Speed Reg Ki]. The Alternate feedback sources uses the P129 [Alt Vel FdbkFltr] filter setting and tuning gains set in P648 [Alt Speed Reg BW], P649 [Alt Speed Reg Kp], and P650 [Alt Speed Reg Ki]. Bit 8 "Delayed Ref" – When this bit is set, an additional processor scan delay period is inserted between the P594 [Ramped Spd Ref] and the input to the Speed Reference filter. This delay is intended to be used in applications where multiple, coordinated drives are used. A drive that supplies the speed reference for use by other drives to follow would typically use this delay. The delay would allow time for the speed reference to reach the other units before it is acted upon by the sourcing unit, thereby synchronizing the speed reference among all units. When this bit is clear, no speed reference delay is inserted. Bit 9 "NoScrvSpdChg" – Set this bit to discontinue the S Curve acceleration/deceleration profile immediately when the actual speed reference changes while completing the desired S Curve. The S Curve profile restarts on the new acceleration/deceleration ramp.																																																								
			<b>636 Speed Reg BW</b> Speed Regulator Bandwidth Sets the speed loop bandwidth and determines the dynamic behavior of the speed loop. As bandwidth increases, the speed loop becomes more responsive and can track a faster changing speed reference. A change to this parameter will cause an automatic update of P645 [Speed Reg Kp], P647 [Speed Reg Ki] and P644 [Spd Err Fltr BW]. The configuration settings for Inertia Adaption (product dependent) will also be automatically selected when this feature is enabled. To disable the automatic gain and filter update, set this parameter to a value of zero.  The maximum allowable value of this parameter will be limited by the ratio of P646 [Speed Reg Max Kp] to P76 [Total Inertia], and the type of speed feedback source in use (encoder vs. open loop). For operation following an Automatic Tach Switchover, the bandwidth specified in P648 [Alt Speed Reg BW] will be used.	Units: R/S Default: Calculated Min/Max: 0.00 / Calculated	RW	Real																																																					

File	Group	No.	Display Name Full Name Description	Values	Read-Write	Data Type
SPEED CONTROL	Speed Regulator	637	<b>SReg FB Fltr Sel</b> Speed Regulator Feedback Filter Select Selects the amount of filtering applied to the feedback channel of the speed regulator, and is only active in FV motor control modes (P35). When set to any of the custom settings (3, 4, or 5) the filter is configured using the values set in P638 [SReg FB FltrGain] and P639 [SReg FB Fltr BW]. Settings 4 and 5 initialize the values for light and heavy respectively.	Default: 0 = "Off" Options: 0 = "Off" 1 = "Light" 2 = "Heavy" 3 = "Custom" 4 = "SetCustLight" 5 = "SetCustHeavy"	RW	32-bit Integer
		638	<b>SReg FB FltrGain</b> Speed Regulator Feedback Filter Gain Sets the gain of the speed regulator feedback filter when P637 [SReg FB Fltr Sel] is set to one of the "Custom" settings (3, 4, or 5). A gain value of zero results in a filter characteristic that behaves as a first order low pass. A gain value ranging between zero and one results in a lag type filter. A gain value greater than one results in a lead type filter. A gain value of one will disable (bypass) the filter.	Default: 0.700 Min/Max: -5.000 / 20.000	RW	Real
		639	<b>SReg FB Fltr BW</b> Speed Regulator Feedback Filter Bandwidth Sets the bandwidth of the speed regulator feedback filter when P637 [SReg FB Fltr Sel] is set to one of the "Custom" settings (3, 4, or 5). A value of zero will disable (bypass) the filter.	Units: R/S Default: 35.00 Min/Max: 0.00 / 3760.00	RW	Real
		640	<b>Filtered SpdFdbk</b> Filtered Speed Feedback Displays the output of the filter that is applied by P637 [SReg FB Fltr Sel].	Units: Hz RPM Default: 0.00 Min/Max: -/+P27 [Motor NP Hertz] x 8 -/+P28 [Motor NP RPM] x 8	RO	Real
		641	<b>Speed Error</b> Speed Error Displays the error (difference) between the P597 [Final Speed Ref] (+) and the P640 [Filtered SpdFdbk] (-). This error signal is the primary input for the Vector control mode speed regulator.	Units: Hz RPM Default: 0.00 Min/Max: -/+P27 [Motor NP Hertz] x 8 -/+P28 [Motor NP RPM] x 8	RO	Real
		642	<b>755 Servo Lock Gain</b> Servo Lock Gain Sets the gain of an additional integrator in the Vector control mode speed regulator. The effect of Servo Lock is to increase stiffness of the speed response to a load disturbance. It behaves like a position regulator with velocity feed forward, but without the pulse accuracy of a true position regulator. Gain should normally be set to less than 1/3 speed regulator bandwidth, or for the desired response. A value of zero disables this feature.	Units: /Sec Default: 0.000 Min/Max: 0.000 / 300.000	RW	Real
		643	<b>SpdReg AntiBckup</b> Speed Regulator Anti-backup Allows control of over-shoot/under-shoot in the step response of the Vector control mode speed regulator. Over-shoot/under-shoot can be effectively eliminated with a setting of 0.3, which will remove backup of the motor shaft when zero speed is reached. This parameter has no affect on the drive's response to load changes. A value of zero disables this feature.	Default: 0.0000 Min/Max: 0.0000 / 0.5000	RW	Real



File	Group	No.	Display Name Full Name Description	Values	Read-Write	Data Type
SPEED CONTROL	Speed Regulator	644	<b>Spd Err Fltr BW</b> Speed Error Filter Bandwidth Sets the bandwidth of a 2nd order Butterworth low pass filter that is located in the proportional gain section of the speed regulator (in FV motor control modes). It filters a signal that is derived from P641 [Speed Error]. The purpose of this filter is to reduce quantization noise. When P636 [Speed Reg BW] is set to a non-zero value, this filter will be automatically set. If P636 [Speed Reg BW] is set to zero, this filter setting must be manually adjusted. It is normally set to at least 3 to 5 times the value of P636 [Speed Reg BW]. A value of zero disables the filter. The rules that are used to set the error filter bandwidth in automatic mode are as follows: 1. If the primary motor velocity feedback is Open Loop, then the error filter is set to 5 times P636 [Speed Reg BW]. 2. If a primary motor velocity feedback device has been selected and P704 [InAdp LdObs Mode] = 1 "InertiaAdapt," then the error filter is set to 3 times P636 [Speed Reg BW]. 3. If a primary motor velocity feedback device has been selected and P704 [InAdp LdObs Mode] = 0 "Disabled" or 2 "LoadObserver" then the error filter is using a table look up value determined by the setting of P126 [Pri Vel FdbkFltr]. <b>Important:</b> When Auto Tach Switchover is enabled through P635 [Spd Options Ctrl], this filter adjustment applies only to the primary feedback source. The filter setting P651 [AltSpdErr FltrBW] is used for the alternate feedback source.	Units: R/S Default: 50.00 Min/Max: 0.00 / 8000.00	RW	Real
		645	<b>Speed Reg Kp</b> Speed Regulator Kp Sets the proportional gain of the speed regulator (in FV motor control modes). This value is automatically calculated based on the bandwidth setting in P636 [Speed Reg BW] and P76 [Total Inertia]. The proportional gain may be manually adjusted by setting P636 [Speed Reg BW] to a value of zero. Proportional gain has effective scaling of (per unit torque) / (per unit speed). The maximum allowable value of this parameter is limited by P76 [Total Inertia] and P646 [Speed Reg Max Kp].	Default: 20.00 Min/Max: 0.00 / P646 [Speed Reg Max Kp]	RW	Real
		646	<b>Speed Reg Max Kp</b> Speed Regulator Maximum Kp Limits the maximum value of P645 [Speed Reg Kp] and P649 [Alt Speed Reg Kp]. When gains are automatically calculated, this parameter is necessary to limit the amplification of noise with increased inertia.	Default: 3000.00 Min/Max: 0.00 / 3000.00	RW	Real
		647	<b>Speed Reg Ki</b> Speed Regulator Ki Sets the integral gain of the speed regulator (in FV motor control modes). This value is automatically calculated based on the bandwidth setting in P636 [Speed Reg BW], P645 [Speed Reg Kp] and P653 [Spd Loop Damping]. Integral gain may be manually adjusted by setting P636 [Speed Reg BW] to a value of zero. Integral gain has effective scaling of (per unit torque/seconds) / (per unit speed).	Units: /Sec Default: 50.00 Min/Max: 0.00 / 100000.00	RW	Real
		648	<b>Alt Speed Reg BW</b> Alternate Speed Regulator Bandwidth Provides an independent setting for the same function as P636 [Speed Reg BW], but is active only when Automatic Feedback Loss Switchover occurs (indicated by Bit 5 of P936 [Drive Status 2]). A change to this parameter will cause an automatic update of P649 [Alt Speed Reg Kp], P650 [Alt Speed Reg Ki] and P651 [AltSpdErr FltrBW]. See P636 for additional information regarding speed regulator bandwidth. Also see P635 [Spd Options Ctrl] to enable the Auto Tach Switchover feature.	Units: R/S Default: 10.00 Min/Max: 0.00 / Calculated	RW	Real




File	Group	No.	Display Name Full Name Description	Values		Read-Write	Data Type
SPEED CONTROL	Speed Regulator	649	<b>Alt Speed Reg Kp</b> Alternate Speed Regulator Kp Provides an independent setting for the same function as P645 [Speed Reg Kp], but is active only when Automatic Feedback Loss Switchover occurs (indicated by Bit 5 of P936 [Drive Status 2]). This value is automatically calculated based on the bandwidth setting in P648 [Alt Speed Reg BW] and P76 [Total Inertia]. The proportional gain may be manually adjusted by setting P648 [Alt Speed Reg BW] to a value of zero.	Default: Min/Max:	20.00 0.00 / Calculated	RW	Real
		650	<b>Alt Speed Reg Ki</b> Alternate Speed Regulator Ki Provides an independent setting for the same function as P647 [Speed Reg Ki], but is active only when Automatic Feedback Loss Switchover occurs (indicated by Bit 5 of P936 [Drive Status 2]). This value is automatically calculated based on the bandwidth setting in P648 [Alt Speed Reg BW], P649 [Alt Speed Reg Kp] and P653 [Spd Loop Damping]. Integral gain may be manually adjusted by setting P648 [Alt Speed Reg BW] to a value of zero.	Default: Min/Max:	50.00 0.00 / 100000.00	RW	Real
		651	<b>AltSpdErr FltrBW</b> Alternate Speed Error Filter Bandwidth Provides an independent setting for the same function as P644 [Spd Err Fltr BW], but is active only when Automatic Feedback Loss Switchover occurs (indicated by Bit 5 of P936 [Drive Status 2]). When P648 [Alt Speed Reg BW] is set to a non-zero value, this filter setting will be automatically selected. If P648 [Alt Speed Reg BW] is set to zero, then this filter setting must be manually adjusted. An error filter value of 0 will disable the filter. This filter is normally set to at least 3 to 5 times the value of P648 [Alt Speed Reg BW]. Units for the error filter are radians/second (R/S). The rules that are used to set the error filter bandwidth in automatic mode are as follows: 1. If the alternate motor velocity feedback is Open Loop, then the error filter is set to 5 times P648 [Alt Speed Reg BW]. 2. If an alternate motor velocity feedback device has been selected and P704 [InAdp LdObs Mode] = 1 "InertiaAdapt," then the error filter is set to 3 times P648 [Alt Speed Reg BW]. 3. If an alternate motor velocity feedback device has been selected and P704 [InAdp LdObs Mode] 0 "Disabled" or 2 "LoadObserver" then the error filter is using a table look up value determined by the setting of P129 [Alt Vel FdbkFltr].	Units: Default: Min/Max:	R/S 50.00 0.00 / 8000.00	RW	Real
		652	<b>SReg Trq Preset</b> Speed Regulator Torque Preset Sets the initial value of P654 [Spd Reg Int Out]. This is the output of the vector speed regulator's integral channel, and will be present in P654 [Spd Reg Int Out] when the regulator is first enabled (for example, upon rise of start or jog). The normal, default setting for this parameter is zero. In some applications, it may be necessary to preset the speed regulator integrator to a non-zero setting. This will result in the regulator's output reaching its final steady state value sooner than it would if the integrator started from zero.	Units: Default: Min/Max:	% 0.00 -/+800.00	RW	Real
		653	<b>Spd Loop Damping</b> Speed Loop Damping Sets the damping factor of the vector speed loop's characteristic equation. Damping will affect the integral gain when a non-zero bandwidth has been entered. A damping factor of 1.0 is considered critical damping. Lowering the damping will produce faster load disturbance rejection, but may cause a more oscillatory response. When the speed regulator bandwidth is zero, gains are set manually and damping factor has no effect.	Default: Min/Max:	1.0000 0.5000 / 65.0000	RW	Real

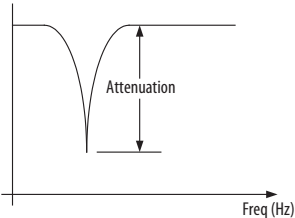
File	Group	No.	Display Name Full Name Description	Values	Read-Write	Data Type
SPEED CONTROL	Speed Regulator	654	<b>Spd Reg Int Out</b> Speed Regulator Integrator Output Displays the current value of the vector speed regulator's integral channel. A value of 100% represents rated motor torque.	Units: % Default: 0.00 Min/Max: -/+800.00	RO	Real
		655	<b>Spd Reg Pos Lmt</b> Speed Regulator Positive Limit Adjusts the upper limit of the vector speed regulator's output. A value of 100% represents rated motor torque.	Units: % Default: 300.00 Min/Max: 0.00 / 600.00	RW	Real
		656	<b>Spd Reg Neg Lmt</b> Speed Regulator Negative Limit Adjusts the lower limit of the vector speed regulator's output. A value of 100% represents rated motor torque.	Units: % Default: -300.00 Min/Max: -600.00 / 0.00	RW	Real
		657	<b>SReg OutFtr Sel</b> Speed Regulator Output Filter Select Selects the amount of filtering applied to the vector speed regulator's output. When set to any of the custom settings (3, 4, or 5) the filter is configured using the values set in P658 [SReg OutFtrGain] and P659 [SReg OutFtr BW]. Settings 4 and 5 initialize the values for light and heavy respectively.	Default: 0 = "Off" Options: 0 = "Off" 1 = "Light" 2 = "Heavy" 3 = "Custom" 4 = "SetCustLight" 5 = "SetCustHeavy"	RW	32-bit Integer
		658	<b>SReg OutFtrGain</b> Speed Regulator Output Filter Gain Sets the gain of the vector speed regulator's output filter when P657 [SReg OutFtr Sel] is set to one of the "Custom" settings (3, 4, or 5). A gain value of zero results in a filter characteristic that behaves as a first order low pass. A gain value ranging between zero and one results in a lag type filter. A gain value greater than one results in a lead type filter. A gain value of one will disable (bypass) the filter.	Default: 1.000 Min/Max: -/+5.000	RW	Real
		659	<b>SReg OutFtr BW</b> Speed Regulator Output Filter Bandwidth Sets the bandwidth of the speed regulator's output filter when P657 [SReg OutFtr Sel] is set to one of the "Custom" settings (3, 4, or 5). A value of zero will disable (bypass) the filter.	Units: R/S Default: 35.00 Min/Max: 0.00 / 3760.00	RW	Real
		660	<b>SReg Output</b> Speed Regulator Output Displays the output of the vector speed regulator. This signal will be routed to the P685 [Selected Trq Ref] when P313 [Actv SpTqPs Mode] has selected the output of the speed regulator. A value of 100% represents rated motor torque.	Units: % Default: 0.00 Min/Max: -/+ 800.00	RO	Real
		663	<b>VHzSV Spd Reg Kp</b> Volts per Hertz Sensorless Vector Speed Regulator Proportional Gain Adjusts the proportional gain of the Speed Regulator used in non-vector modes according to P35 [Motor Ctrl Mode]. The output of this regulator will adjust P623 [VHzSV SpdTrimReg] when P131 [Active Vel Fdbk] originates from a feedback device.	Default: 20.00 Min/Max: 0.00 / 3000.00	RW	Real
		664	<b>VHzSV Spd Reg Ki</b> Volts per Hertz Sensorless Vector Speed Regulator Integral Gain Adjusts the integral gain of the Speed Regulator used in non-vector modes according to P35 [Motor Ctrl Mode]. The output of this regulator will adjust P623 [VHzSV SpdTrimReg] when P131 [Active Vel Fdbk] originates from a feedback device.	Units: /Sec Default: 50.00 Min/Max: 0.00 / 100000.00	RW	Real

File	Group	No.	Display Name Full Name Description	Values	Read-Write	Data Type
SPEED CONTROL	Speed Comp	665	<b>Speed Comp Sel</b> Speed Compensation Select Configures the Speed Compensation function, which is used in Vector Control modes to create a feed forward compensation that is added into the speed reference. This helps compensate for position tracking errors during acceleration. These tracking errors are caused by the sample and hold process and delays caused by the position to velocity FIR filter. Speed Compensation will help reduce position error in position follower applications. Available settings for this parameter are: “Disabled” (0) – Function is disabled, speed compensation does not affect the speed reference. “Ramped Ref” (1) – Speed compensation function is enabled and uses an internally generated ramped speed reference signal. The rate of change (derivative) of the speed reference becomes the input to the Speed Compensation function. This is the most common setting when speed compensation is in use. “Rate Ref” (2) – Speed compensation function is enabled and uses an externally generated speed rate signal. The rate of change or derivative of the speed reference is supplied by P596 [Speed Rate Ref]. This signal is typically supplied by an external controller when the speed reference ramp is generated external to the drive.	Default: 0 = “Disabled” Options: 0 = “Disabled” 1 = “Ramped Ref” 2 = “Rate Ref”	RW	32-bit Integer
		666	<b>Speed Comp Gain</b> Speed Compensation Gain Adjusts the magnitude of P667 [Speed Comp Out]. This gain can be either manually set or automatically determined as part of automatic gain mode for Vector speed control. Automatic mode can be activated by selecting a motor speed feedback device in P125 [Pri Vel Fdbk Sel] and setting a non-zero speed regulator bandwidth in P636 [Speed Reg BW]. In automatic mode, the gain is calculated internally using a table lookup from the interrupt times and delays of the speed feedback FIR filter. For any other case – non-vector control, open loop speed feedback, or zero bandwidth setting, the speed compensation gain must be manually adjusted.	Default: -2.50 Min/Max: -/+32767.00	RW	Real
		667	<b>Speed Comp Out</b> Speed Compensation Output Displays the output of the Speed Compensation function. This value will be summed with the speed reference, following the application of P555 [Spd Ref Scale].	Units: Hz RPM Default: 0.00 Min/Max: -/+P27 [Motor NP Hertz] x 8 -/+P28 [Motor NP RPM] x 8	RO	Real

## Drive (Port 0) Torque Control File

File	Group	No.	Display Name Full Name Description	Values	Read-Write	Data Type
TORQUE CONTROL	Torque Limits	670	<b>Pos Torque Limit</b> Positive Torque Limit Defines the torque limit for the positive torque reference value. The reference will not be allowed to exceed this value. Only active in Flux Vector (FV) motor control modes (P35).	Units: % Default: 200.00 Min/Max: 0.00 / 800.00	RW	Real
		671	<b>Neg Torque Limit</b> Negative Torque Limit Defines the torque limit for the negative torque reference value. The reference will not be allowed to exceed this value. Only active in Flux Vector (FV) motor control modes (P35).	Units: % Default: -200.00 Min/Max: -800.00 / 0.00	RW	Real

File	Group	No.	Display Name Full Name Description	Values	Read-Write	Data Type
TORQUE CONTROL	Torque Reference	675	<b>Trq Ref A Sel</b>	Default: 676	RW	32-bit Integer
		680	<b>Trq Ref B Sel</b>  Torque Reference A, B Select Selects the source for a torque reference, used when the drive is configured to command torque according to P309...312 [SpdTrqPsn Mode n]. The values of the torque reference sources are added together to provide a single torque reference. Only active in Flux Vector (FV) motor control modes (P35).	Default: 681 Min/Max: 0 / 159999		
		676	<b>Trq Ref A Stpt</b>	Units: % Default: 0.00	RW	Real
		681	<b>Trq Ref B Stpt</b> Torque Reference A, B Setpoint A digital torque value to be used as a possible source for P675 and P680 respectively. Only active in Flux Vector (FV) motor control modes (P35).	Min/Max: -/+800.00		
		677	<b>Trq Ref A AnlgHi</b>	Units: % Default: 100.00	RW	Real
		682	<b>Trq Ref B AnlgHi</b> Torque Reference A, B Analog High Used only when an analog input is selected as a torque reference according to P676 or P681. Sets the torque value that corresponds to P51/61 [Anlg In $n$ Hi] on an I/O module or on the main control (product dependent). This establishes scaling throughout the range. Only active in Flux Vector (FV) motor control modes (P35).	Min/Max: -/+800.00		
		678	<b>Trq Ref A AnlgLo</b>	Units: % Default: 0.00	RW	Real
		683	<b>Trq Ref B AnlgLo</b> Torque Reference A, B Analog Low Used only when an analog input is selected as a torque reference according to P676 or P681. Sets the torque value that corresponds to P52/62 [Anlg In $n$ Lo] on an I/O module or on the main control (product dependent). This establishes scaling throughout the range. Only active in Flux Vector (FV) motor control modes (P35).	Min/Max: -/+800.00		
679	<b>Trq Ref A Mult</b>	Default: 1.000	RW	Real		
684	<b>Trq Ref B Mult</b> Torque Reference A, B Multiplier A multiplier that is applied to the values referenced by P675 and P680 respectively. A value of 1 leaves the reference unaffected. Negative values invert the reference. Only active in Flux Vector (FV) motor control modes (P35).	Min/Max: -/+1000.000				





File	Group	No.	Display Name Full Name Description	Values		Read-Write	Data Type
TORQUE CONTROL	Torque Reference	685	<b>Selected Trq Ref</b> Selected Torque Reference Displays the torque value of the selected torque reference (dynamic selection according to P313 [Actv SpTqPs Mode]). This value will be summed with P686 [Torque Step]. The result is then applied to the input of the notch filter located in the Vector torque reference section. Only active in Flux Vector (FV) motor control modes (P35).	Units: % Default: 0.00 Min/Max: -/+800.00		RO	Real
		686	<b>Torque Step</b> Torque Step Defines the amount of torque reference step change to simulate a load disturbance, used to test the response. This value is added to the main torque reference P685 [Selected Trq Ref], and then applied to the input of the notch filter located in the Vector control torque reference section. Only active in Flux Vector (FV) motor control modes (P35).	Units: % Default: 0.00 Min/Max: -/+800.00		RW	Real
		687	<b>Notch Fltr Freq</b> Notch Filter Frequency The center frequency for the Notch filter located in the Vector control torque reference section. To disable, set to zero (0). Only active in Flux Vector (FV) motor control modes (P35).	Units: Hz Default: 0.00 Min/Max: 0.00 / 500.00		RW	Real
		688	<b>Notch Fltr Atten</b> Notch Filter Attenuation Sets the attenuation of the notch filter located in the Vector control torque reference section. Attenuation is the ratio of the notch filter input signal to its output at the P687 [Notch Fltr Freq]. An attenuation of 30 means that the notch output is 1/30th of the input at the specified frequency. Only active in Flux Vector (FV) motor control modes (P35). 	Default: 50.000 Min/Max: 0.000 / 10000.000		RW	Real
		689	<b>Filtered Trq Ref</b> Filtered Torque Reference Displays the output of the notch filter defined by P687 and P688. If P704 [InAdp LdObs Mode] indicates that either the Inertia Adaption or Load Estimate functions are active, then the filtered torque reference will also be modified by these functions. Only active in Flux Vector (FV) motor control modes (P35).	Units: % Default: 0.00 Min/Max: -/+800.00		RO	Real
		690	<b>Limited Trq Ref</b> Limited Torque Reference Displays the torque reference value after filtering (P689), power limits, torque limits, and current limits have been applied. P945 [At Limit Status] indicates what limiting conditions are active. Motor power limits are set by P426 [Regen Power Lmt] and P427 [Motor Power Lmt]. Motor torque limits are set by P670 [Pos Torque Limit] and P671 [Neg Torque Limit]. Motor current limit is set by P422 [Current Limit 1] or P423 [Current Limit 2]. Only active in Flux Vector (FV) motor control modes (P35).	Units: % Default: 0.00 Min/Max: -/+800.00		RO	Real



File	Group	No.	Display Name Full Name Description	Values	Read-Write	Data Type
TORQUE CONTROL	Inertia Comp	695	<b>755 Inertia CompMode</b> Inertia Compensation Mode The inertia compensation function calculates a feed forward torque signal P699 [Inertia Comp Out]. Inertia compensation attempts to predict the motor torque required to accelerate and decelerate an inertial load. The P699 [Inertia Comp Out] signal is summed with P660 [SReg Output] and becomes an input available to the P313 [Actv SpIqPs Mode] selector. The inputs to the inertia comp function are the rate of change of motor speed reference and P76 [Total Inertia]. Only active in Flux Vector (FV) motor control modes (P35). This parameter enables the inertia comp function and selects possible sources of motor speed reference as follows: "Disabled" (0) – Inertia compensation function is disabled. P699 [Inertia Comp Out] is zero so the motor torque reference is not affected. "Int Ramp Ref" (1) – Inertia compensation is enabled. The function is configured to use the rate of change of P595 [Filtered Spd Ref]. This is the typical setting that should be used for inertia compensation on a stand-alone drive. "Ext Ramp Ref" (2) – Inertia compensation is enabled. The function is configured to use the rate of change of P700 [Ext Ramped Ref]. This setting is available for applications that supply a ramped speed reference external to the drive. "Spd Rate Ref" (3) – Inertia compensation is enabled. The function is configured to use the P596 [Speed Rate Ref]. This parameter should contain a value that represents the rate of change of the motor speed reference. This setting is available for applications that supply a ramped speed reference external to the drive.	Default: 0 = "Disabled" Options: 0 = "Disabled" 1 = "Int Ramp Ref" 2 = "Ext Ramp Ref" 3 = "Spd Rate Ref"	RW	32-bit Integer
		696	<b>755 Inertia Acc Gain</b> Inertia Acceleration Gain Sets the acceleration gain for the inertia compensation function. A value of 1 produces 100% compensation. Only active in Flux Vector (FV) motor control modes (P35).	Default: 1.0000 Min/Max: 0.0000 / 2.0000	RW	Real
		697	<b>755 Inertia Dec Gain</b> Inertia Deceleration Gain Sets the deceleration gain for the inertia compensation function. A value of 1 produces 100% compensation. Only active in Flux Vector (FV) motor control modes (P35).	Default: 1.0000 Min/Max: 0.0000 / 2.0000	RW	Real
		698	<b>755 Inert Comp LPFBW</b> Inertia Compensation Low Pass Filter Bandwidth Sets the bandwidth of a low pass filter for the inertia compensation function. The output of this filter supplies P699 [Inertia Comp Out]. Only active in Flux Vector (FV) motor control modes (P35).	Units: R/S Default: 35.00 Min/Max: 0.00 / 2000.00	RW	Real
		699	<b>755 Inertia Comp Out</b> Inertia Compensation Output Displays the output of the inertia compensation function. The P699 [Inertia Comp Out] signal is summed with P660 [SReg Output] and becomes an input available to the P313 [Actv SpIqPs Mode] selector. Inertia compensation provides a torque feed forward signal during changes in motor speed reference. Only active in Flux Vector (FV) motor control modes (P35).	Units: % Default: 0.00 Min/Max: -/+800.00	RO	Real
		700	<b>755 Ext Ramped Ref</b> External Ramped Reference This parameter is meant for an external motor speed ramp input signal. This signal will be used by the inertia compensation function when P695 [InertiaComp Mode] = 2 "Ext Ramp Ref". This parameter will be entered in units of Hz or RPM, depending on the value of P300 [Speed Units]. Only active in Flux Vector (FV) motor control modes (P35).	Units: Hz RPM Default: 0.00 Min/Max: -/+P27 [Motor NP Hertz] x 8 -/+P28 [Motor NP RPM] x 8	RW	Real

File	Group	No.	Display Name Full Name Description	Values	Read-Write	Data Type
TORQUE CONTROL	Inertia Adaption	704	<p><b>755 InAdp LdObs Mode</b></p> <p>Inertia Adaption Load Observer Mode</p> <p>Used to enable operation of either Inertia Adaption or Load Observer.</p> <p>These System Control modes are only available in Vector Control mode when using a motor speed feedback device. The value of P76 [Total Inertia] must be valid in order for these features to work correctly. The P70 [Autotune] setting 4 "Inertia Tune" can be used to measure the System Inertia. Regardless of the Sys Control mode used, the parameter P707 [Load Estimate] is updated for monitoring purposes. Only active in Flux Vector (FV) motor control modes (P35).</p> <p>The possible settings for Sys Control Sel are:</p> <p>"Disabled" (0) – Both Inertia Adaption and Load Observer functions are disabled. P708 [InertiaTrqAdd] is zero so the motor torque reference is not affected. P707 [Load Estimate] is still valid, provided that the drive is in Vector Mode, using a motor speed feedback device, and a valid P76 [Total Inertia] is used.</p> <p>"InertiaAdapt" (1) – Inertia Adaption function is enabled. The Inertia Adaption function will provide enhanced stability, higher bandwidths and dynamic stiffness. Inertia Adaption is especially useful in systems with a gear-box that become, in effect, disconnected from the load. Inertia Adaption may also be used for motors with very little inertia that otherwise would lack dynamic stiffness, even at high bandwidths. The output of the Inertia Adaption function P708 [InertiaTrqAdd], will subtract from the motor torque reference.</p> <p>"LoadObserver" (2) – Load Observer function is enabled. The Load Observer function removes or greatly reduces the effects of load disturbances and provides quicker system response. The output of the Load Observer function is similar to P707 [Load Estimate], but has a filter setting determined by P711 [Load Observer BW]. The Load Observer's output signal will add to the motor torque reference.</p>	<p>Default: 0 = "Disabled"</p> <p>Options: 0 = "Disabled"</p> <p>1 = "InertiaAdapt"</p> <p>2 = "LoadObserver"</p>	RW	32-bit Integer
		705	<p><b>755 Inertia Adapt BW</b></p> <p>Inertia Adapt Bandwidth</p> <p>Sets the bandwidth of a low pass filter located in the output of the Inertia Adaption function. This parameter should typically be set to match the bandwidth of the drive's speed regulator. This matching setting is automatically made when the Inertia Adaption function is active and the speed regulator bandwidth (P636 [Speed Reg BW]), is set to a non-zero value. If the speed regulator bandwidth is set to zero, then this filter setting must be manually adjusted. Only active in Flux Vector (FV) motor control modes (P35).</p>	<p>Units: R/S</p> <p>Default: 10.00</p> <p>Min/Max: 1.00 / 1000.00</p>	RW	Real
		706	<p><b>755 InertiaAdaptGain</b></p> <p>Inertia Adaption Gain</p> <p>Sets a multiplier of system inertia used when the Inertia Adaption function is selected P704 [InAdp LdObs Mode] = 1 "InertiaAdapt." This gain has no effect on the parameter P707 [Load Estimate]. Higher gain values may cause high frequency ringing, while smaller values may cause fundamental load instability. This gain should typically range from 0.3 to 1.0 with 0.5 nominal best. The gain setting of 0.5 is automatically made when the speed regulator bandwidth (P636 [Speed Reg BW]), is set to a non-zero value. If the speed regulator bandwidth is set to zero, then this gain setting must be manually adjusted. Only active in Flux Vector (FV) motor control modes (P35).</p>	<p>Default: 0.500</p> <p>Min/Max: 0.300 / 1.000</p>	RW	Real
		707	<p><b>755 Load Estimate</b></p> <p>Load Estimate</p> <p>Displays an estimated load torque value for the drive. This value is only available in Vector Control mode when using a motor speed feedback device. The load estimate does not include any torque required to accelerate or decelerate the motor. In order to be accurate, the parameter P76 [Total Inertia] must contain a reasonably accurate value. Only active in Flux Vector (FV) motor control modes (P35).</p>	<p>Units: %</p> <p>Default: 0.00</p> <p>Min/Max: -/+800.00</p>	RO	Real

File	Group	No.	Display Name Full Name Description	Values	Read-Write	Data Type
TORQUE CONTROL	Inertia Adaption	708	<b>755 InertiaTrqAdd</b> Inertia Torque Adaption Displays the output of the Inertia Adaption function. This value will be subtracted from the motor torque reference, with the result displayed as P689 [Filtered Trq Ref]. The inertia adaption function will be active when operating in Vector Control mode with a motor speed feedback device and P704 [InAdp LdObs Mode] = 1 "InertiaAdapt." A value of 100% represents rated motor torque. Only active in Flux Vector (FV) motor control modes (P35).	Units: % Default: 0.00 Min/Max: -/+800.00	RO	Real
		709	<b>755 IA LdObs Delay</b> Inertia Adaption Load Observer Delay Adjusts a filter setting that is applied to the active motor velocity feedback source. The purpose of this filter is to reduce the level of noise present in the feedback signal. Note that this filter is the same type but separate from the filters used to provide P127 [Pri Vel Feedback] and P130 [Alt Vel Feedback]. The derivative of the Sys Control Delay filtered motor velocity signal will be a Motor Acceleration Feedback signal. The Motor Acceleration Feedback is applied to the Inertia Adaption and Load Observer/ Load Estimate functions. This is moving average type filter that has a delay setting of N, where N is an integer number (0, 1, 2 . . .). A setting of zero provides no filtering and no delay. Larger values of N result in more filtering and more delay. The best setting for this filter will depend on the level of noise present in the feedback signal and the bandwidth setting of the velocity regulator. Only active in Flux Vector (FV) motor control modes (P35).	Default: 3 = "50R/S Noise" Options: 0 = "190R/S Noise" 1 = "160R/S Noise" 2 = "100R/S Noise" 3 = "50R/S Noise" 4 = "25R/S Noise" 5 = "12R/S Noise" 6 = "6R/S Noise" 7 = "3R/S Noise"	RW	32-bit Integer
		710	<b>755 InertAdptFitrBW</b> Inertia Adaption Filter Bandwidth Sets the bandwidth of a low pass filter located in the output of the vector control speed regulator and used in connection with the Inertia Adaption function. The bandwidth of this filter should typically be set to five times the bandwidth of the speed regulator. This setting is automatically made when the Inertia Adaption function is active and the speed regulator bandwidth (P636 [Speed Reg BW]), is set to a non-zero value. If the speed regulator bandwidth is set to zero, then this filter setting must be manually adjusted. Only active in Flux Vector (FV) motor control modes (P35).	Units: R/S Default: 50.00 Min/Max: 0.00 / 1000.00	RW	Real
		711	<b>755 Load Observer BW</b> Load Observer Bandwidth Sets the bandwidth of a low pass filter located in the output of the Load Observer function. Typical filter settings range from 10 radians/second to 150 radians/second with the higher values being more responsive to disturbances but with increased system noise. There is no nominal best setting, but 40 radians/second is a suggested starting point. This selection may not function well in sloppy geared systems. Only active in Flux Vector (FV) motor control modes (P35).	Units: R/S Default: 40.00 Min/Max: 1.00 / 1000.00	RW	Real



File	Group	No.	Display Name Full Name Description	Values	Read-Write	Data Type
TORQUE CONTROL	Friction Comp	1560	<b>755 FrctnComp Mode</b> Friction Compensation Mode The friction compensation function calculates a feed forward torque signal P1567 [FrctnComp Out]. Friction compensation attempts to predict the motor torque required to counteract load friction. The [FrctnComp Out] signal is summed with P685 [Selected Trq Ref] and P686 [Torque Step]. This parameter enables the friction comp function and selects possible sources of motor speed reference as follows: “Disabled” (0) – Friction compensation function is disabled. P1567 [FrctnComp Out] is zero so the motor torque reference is not affected. “Int Ramp Ref” (1) – Friction compensation is enabled. The function is configured to use the P595 [Filtered Spd Ref] summed with the position reference speed feed forward. This is the typical setting that should be used for friction compensation on a stand-alone drive when operating in position or speed mode. “Ext Ramp Ref” (2) – Friction compensation is enabled. The function is configured to use P700 [Ext Ramped Ref]. This setting is available for applications that supply a ramped speed reference external to the drive. “Speed Fdbk” (3) – Friction compensation is enabled. The function is configured to use P640 [Filtered SpdFdbk]. A feedback device must be used – the speed feedback source cannot be open loop feedback. This setting should be used when operating in torque mode (min/max/torque).	Default: 0 = “Disabled” Options: 0 = “Disabled” 1 = “Int Ramp Ref” 2 = “Ext Ramp Ref” 3 = “Speed Fdbk”	RW	32-bit Integer
		1561	<b>755 FrctnComp Trig</b>  Friction Compensation Trigger Sets the starting speed or trigger speed at which the friction compensation will be applied when leaving the region near zero speed. The initial value for P1567 [FrctnComp Out] at this speed will be P1564 [FrctnComp Stick]. Friction compensation will remain active until the speed reference drops below the trigger speed minus P1562 [FrctnComp Hyst] speed. At these low speeds, P1567 [FrctnComp Out] returns to zero.	Units: Hz RPM Default: 0.15 Min/Max: 0.00 / 7.94	RW	Real
		1562	<b>755 FrctnComp Hyst</b>  Friction Compensation Hysteresis This parameter together with P1561 [FrctnComp Trig] establishes a speed band around zero speed. Friction compensation will be inactive (zero output) when the speed reference is inside this band and active when outside. The points at which friction comp becomes active and inactive differ by the amount of speed set in this parameter.	Units: Hz RPM Default: 0.06 Min/Max: 0.00 / 7.94	RW	Real
		1563	<b>755 FrctnComp Time</b>  Friction Compensation Time Sets the time interval that the stiction torque will be applied. When initially leaving the zero speed region, the value in P1564 [FrctnComp Stick] will be used for the non-viscous friction term. After the time period set in this parameter, the non-viscous friction will ramp down to the value set in P1565 [FrctnComp Slip]. For the remainder of the time that [FrctnComp Out] remains non-zero, the non-viscous friction will remain constant at the value of [FrctnComp Slip].	Units: mSec Default: 6 Min/Max: 0 / 18	RW	32-bit Integer
		1564	<b>755 FrctnComp Stick</b>  Friction Compensation Stiction Sets the level for the stiction or static friction torque. This is the torque level required to break away from zero speed. When initially leaving the zero speed region, this level will be used for the non-viscous friction term. After the time period set in P1563 [FrctnComp Time], the non-viscous friction will ramp down to the value set in P1565 [FrctnComp Slip].	Units: % Default: 15.00 Min/Max: 0.00 / 800.00	RW	Real

File	Group	No.	Display Name Full Name Description	Values		Read-Write	Data Type
TORQUE CONTROL	Friction Comp	1565	<b>755 FrctnComp Slip</b>  Friction Compensation Slip Sets the torque level that will be maintained at very low speed once “break away” has been achieved. This value should always be set less than the level in P1564 [FrctnComp Stick]. After the time period set in P1563 [FrctnComp Time], the non-viscous friction will ramp down to this value.	Units: % Default: 10.00 Min/Max: 0.00 / 800.00		RW	Real
		1566	<b>755 FrctnComp Rated</b>  Friction Compensation Rated Sets the torque level that will be output at rated motor speed. The friction compensation routine assumes a linear viscous component that varies in direct proportion to speed reference. The 1567 [FrctnComp Out] value will increase with speed and will equal the level set in this parameter at rated motor speed.	Units: % Default: 20.00 Min/Max: 0.00 / 800.00		RW	Real
		1567	<b>755 FrctnComp Out</b> Friction Compensation Output Displays the torque reference output of the Friction Compensation function. This value is summed with P660 [SReg Output] and P699 [Inertia Comp Out] in the torque control section of the drive.	Units: % Default: 0.00 Min/Max: -/+800.00		RO	Real

# Drive (Port 0) Position Control File

File	Group	No.	Display Name Full Name Description	Values	Read-Write	Data Type																																																																																													
POSITION CONTROL	Position Cfg/Sts	720	<b>PTP PsnRefStatus</b> Point-To-Point Position Reference Status Displays the current operating status of the Point-To-Point Position Planner in the Position Referencing. Options <table border="1"> <thead> <tr> <th></th> <th>Reserved</th> <th>Reserved</th> <th>Reserved</th> <th>Reserved</th> <th>Reserved</th> <th>Reserved</th> <th>Reserved</th> <th>Reserved</th> <th>Reserved</th> <th>Reserved</th> <th>Reserved</th> <th>Reserved</th> <th>Reserved</th> <th>Reserved</th> <th>SpdFRef En</th> <th>PTP Int Hold</th> <th>Ref Complete</th> <th>ZeroFFSpdRef</th> </tr> </thead> <tbody> <tr> <td>Default</td> <td>0</td><td>0</td><td>0</td><td>0</td><td>0</td><td>0</td><td>0</td><td>0</td><td>0</td><td>0</td><td>0</td><td>0</td><td>0</td><td>0</td><td>0</td><td>0</td><td>0</td><td>0</td> </tr> <tr> <td>Bit</td> <td>15</td><td>14</td><td>13</td><td>12</td><td>11</td><td>10</td><td>9</td><td>8</td><td>7</td><td>6</td><td>5</td><td>4</td><td>3</td><td>2</td><td>1</td><td>0</td><td></td><td></td> </tr> </tbody> </table> 0 = False 1 = True		Reserved	Reserved	Reserved	Reserved	Reserved	Reserved	Reserved	Reserved	Reserved	Reserved	Reserved	Reserved	Reserved	Reserved	SpdFRef En	PTP Int Hold	Ref Complete	ZeroFFSpdRef	Default	0	0	0	0	0	0	0	0	0	0	0	0	0	0	0	0	0	0	Bit	15	14	13	12	11	10	9	8	7	6	5	4	3	2	1	0			RO	16-bit Integer																																					
			Reserved	Reserved	Reserved	Reserved	Reserved	Reserved	Reserved	Reserved	Reserved	Reserved	Reserved	Reserved	Reserved	Reserved	SpdFRef En	PTP Int Hold	Ref Complete	ZeroFFSpdRef																																																																															
Default	0	0	0	0	0	0	0	0	0	0	0	0	0	0	0	0	0	0																																																																																	
Bit	15	14	13	12	11	10	9	8	7	6	5	4	3	2	1	0																																																																																			
		721	<b>Position Control</b> Position Control Sets bits to enable various position control functions. Options <table border="1"> <thead> <tr> <th></th> <th>Reserved</th> <th>Reserved</th> <th>Reserved</th> <th>Reserved</th> <th>Reserved</th> <th>Reserved</th> <th>Reserved</th> <th>Reserved</th> <th>Reserved</th> <th>Reserved</th> <th>Reserved</th> <th>Reserved</th> <th>Reserved</th> <th>Reserved</th> <th>Reserved</th> <th>Reserved</th> <th>Reserved</th> <th>Reserved</th> <th>Add Spd Ref</th> <th>PsnWatch2Dir (1)</th> <th>PsnWtch2Arm (1)</th> <th>PsnWatch1Dir (1)</th> <th>PsnWtch1Arm (1)</th> <th>Intgrtr Hold</th> <th>Zero Psn</th> <th>OffsetVel En</th> <th>Offset ReRef</th> <th>Intgrtr En</th> <th>Reserved</th> </tr> </thead> <tbody> <tr> <td>Default</td> <td>0</td><td>0</td><td>0</td><td>0</td><td>0</td><td>0</td><td>0</td><td>0</td><td>0</td><td>0</td><td>0</td><td>0</td><td>0</td><td>0</td><td>0</td><td>0</td><td>0</td><td>0</td><td>0</td><td>0</td><td>0</td><td>0</td><td>0</td><td>0</td><td>0</td><td>0</td><td>0</td><td>0</td><td>0</td><td>0</td> </tr> <tr> <td>Bit</td> <td>31</td><td>30</td><td>29</td><td>28</td><td>27</td><td>26</td><td>25</td><td>24</td><td>23</td><td>22</td><td>21</td><td>20</td><td>19</td><td>18</td><td>17</td><td>16</td><td>15</td><td>14</td><td>13</td><td>12</td><td>11</td><td>10</td><td>9</td><td>8</td><td>7</td><td>6</td><td>5</td><td>4</td><td>3</td><td>2</td><td>1</td><td>0</td> </tr> </tbody> </table> (1) 755 drives only. 0 = Disabled 1 = Enabled		Reserved	Reserved	Reserved	Reserved	Reserved	Reserved	Reserved	Reserved	Reserved	Reserved	Reserved	Reserved	Reserved	Reserved	Reserved	Reserved	Reserved	Reserved	Add Spd Ref	PsnWatch2Dir (1)	PsnWtch2Arm (1)	PsnWatch1Dir (1)	PsnWtch1Arm (1)	Intgrtr Hold	Zero Psn	OffsetVel En	Offset ReRef	Intgrtr En	Reserved	Default	0	0	0	0	0	0	0	0	0	0	0	0	0	0	0	0	0	0	0	0	0	0	0	0	0	0	0	0	0	0	Bit	31	30	29	28	27	26	25	24	23	22	21	20	19	18	17	16	15	14	13	12	11	10	9	8	7	6	5	4	3	2	1	0	RW	32-bit Integer
	Reserved	Reserved	Reserved	Reserved	Reserved	Reserved	Reserved	Reserved	Reserved	Reserved	Reserved	Reserved	Reserved	Reserved	Reserved	Reserved	Reserved	Reserved	Add Spd Ref	PsnWatch2Dir (1)	PsnWtch2Arm (1)	PsnWatch1Dir (1)	PsnWtch1Arm (1)	Intgrtr Hold	Zero Psn	OffsetVel En	Offset ReRef	Intgrtr En	Reserved																																																																						
Default	0	0	0	0	0	0	0	0	0	0	0	0	0	0	0	0	0	0	0	0	0	0	0	0	0	0	0	0	0	0																																																																					
Bit	31	30	29	28	27	26	25	24	23	22	21	20	19	18	17	16	15	14	13	12	11	10	9	8	7	6	5	4	3	2	1	0																																																																			
			Bit 0 "Intgrtr En" – Enables integrator operation. Resetting it resets the integrator. Bit 2 "Offset ReRef" – Permits changing the value of position offsets without changing actual position. The position offsets are the values that are selected by P820 [Psn Offset 1 Sel] and P822 [Psn Offset 2 Sel]. The default position offsets are P821 [Psn Offset 1] and P823 [Psn Offset 2]. Bit 3 "OffsetVel En" – Uses the offset velocity P824 [Psn Offset Vel] for the position offset integrator. Sets the offset integrator bit, P724 [Psn Reg Status] Bit 0 "OffsetIntgrtr" when this bit is on. Bit 4 "Zero Psn" – Puts P836 [Psn Actual] in absolute mode (no differential) with zero position offset. P836 [Psn Actual] sets the value of P847 [Psn Fdbk] - the position P725 [Zero Position]. With Bit 4 "Zero Psn" disabled, P836 [Psn Actual] accumulates the difference in P847 [Psn Fdbk] at each position control scan. P836 [Psn Actual] and P847 [Psn Fdbk] are not always the same and therefore, P836 [Psn Actual] is reset. With Bit 4 "Zero Psn" set, P836 [Psn Actual] directly loads the raw value of P847 after subtracting P725 [Zero Position]. Bit 5 "Intgrtr Hold" – Holds the position integrator in present state. Bit 6 "PsnWtch1Arm" – Enables the position watch 1. Resetting this bit clears the position watch 1 detection P724 [Psn Reg Status] Bit 9 "PsnW1Detect." Bit 7 "PsnWatch1Dir" – Causes the position watch 1 output to be set when P746 [PsnWatch1 DtctlIn] is greater than a set-point selected by the position watch 1 selection P745 [PsnWatch1 Select]. Resetting this bit causes the position watch 1 output to be set when P746 [PsnWatch1 DtctlIn] is less than a set-point selected by the position watch 1 selection P745 [PsnWatch1 Select]. Bit 8 "PsnWtch2Arm" – Enables the position watch 2. Resetting this bit clears the position watch 2 detection P724 [Psn Reg Status] Bit 10 "PsnW2Detect." Bit 9 "PsnWatch2Dir" – Causes the position watch 2 output to be set when P749 [PsnWatch2 DtctlIn] is greater than a set-point selected by the position watch 2 selection P748 [PsnWatch2 DtctlIn]. Resetting this bit causes the position watch 2 output to be set when P749 [PsnWatch2 DtctlIn] is less than a set-point selected by the position watch 2 selection P748 [PsnWatch2 DtctlIn]. Bit 10 "Add Spd Ref" – Adds the speed reference to the output of the position control, when in position control mode.																																																																																																

File	Group	No.	Display Name Full Name Description	Values	Read-Write	Data Type																																																																																																
POSITION CONTROL	Position Cfg/Sts	722	<b>Psn Selected Ref</b> Position Selected Reference Indicates output of the position referencing. When the Spd/Torq/Pos mode P313 [Actv SpTqPs Mode] is the position direct mode (Option 10), the value of the position direct reference P767 [Psn Direct Ref] appears on this parameter. When the Spd/Torq/Pos mode P313 [Actv SpTqPs Mode] is the position point-to-point mode (Option 7) or the speed/position profiler mode (Option 6), the position point-to-point reference P776 [PTP Reference] appears on this parameter.	Default: 0 Min/Max: -2147483648 / 2147483647	RO	32-bit Integer																																																																																																
		723	<b>Psn Command</b> Position Command Indicates final accumulated command to the position regulator. When the position regulator is not active, this parameter is initialized to P836 [Psn Actual].	Default: 0 Min/Max: -2147483648 / 2147483647	RO	32-bit Integer																																																																																																
		724	<b>Psn Reg Status</b> Position Regulator Status Indicates status of position control logic.  Options	<table border="1"> <thead> <tr> <th></th> <th>Reserved</th> <th>Reserved</th> <th>Reserved</th> <th>Reserved</th> <th>Reserved</th> <th>Reserved</th> <th>Reserved</th> <th>Reserved</th> <th>Reserved</th> <th>Reserved</th> <th>Reserved</th> <th>Reserved</th> <th>Reserved</th> <th>Reserved</th> <th>Reserved</th> <th>Reserved</th> <th>Reserved</th> <th>Reserved</th> <th>InPsn Detect<sup>(1)</sup></th> <th>PsnW2Detect<sup>(1)</sup></th> <th>PsnW1Detect<sup>(1)</sup></th> <th>Intgrtr Hold</th> <th>Psn Reg Actv</th> <th>Spd Lmt Hi</th> <th>Spd Lmt Lo</th> <th>Integ Lmt Hi</th> <th>Integ Lmt Lo</th> <th>Psn Intgrtr</th> <th>Offset ReRef</th> <th>OffsetIntgr</th> </tr> </thead> <tbody> <tr> <td>Default</td> <td>0</td> <td>0</td> <td>0</td> <td>0</td> <td>0</td> <td>0</td> <td>0</td> <td>0</td> <td>0</td> <td>0</td> <td>0</td> <td>0</td> <td>0</td> <td>0</td> <td>0</td> <td>0</td> <td>0</td> <td>0</td> <td>1</td> <td>0</td> <td>0</td> <td>0</td> <td>0</td> <td>0</td> <td>0</td> <td>0</td> <td>0</td> <td>0</td> <td>0</td> <td>0</td> <td>0</td> </tr> <tr> <td>Bit</td> <td>31</td> <td>30</td> <td>29</td> <td>28</td> <td>27</td> <td>26</td> <td>25</td> <td>24</td> <td>23</td> <td>22</td> <td>21</td> <td>20</td> <td>19</td> <td>18</td> <td>17</td> <td>16</td> <td>15</td> <td>14</td> <td>13</td> <td>12</td> <td>11</td> <td>10</td> <td>9</td> <td>8</td> <td>7</td> <td>6</td> <td>5</td> <td>4</td> <td>3</td> <td>2</td> <td>1</td> <td>0</td> </tr> </tbody> </table> <p>(1) 755 drives only. <span style="float: right;">0 = False 1 = True</span></p> <p>Bit 0 "OffsetIntgr" – Indicates the position offset Integrator is active with the position offset integrator bit P721 [Position Control] Bit 3 "OffsetVel En" is on.            Bit 1 "Offset ReRef" – Indicates the position offset re-referencing is active with the position offset re-referencing bit P721 [Position Control] Bit 2 "Offset ReRef" is on.            Bit 2 "Psn Intgrtr" – Indicates the position integrator is active with the position integrator bit P721 [Position Control] Bit 1 "Intgrtr En" is on.            Bit 3 "Integ Lmt Lo" – Indicates the position integrator is at the low limit.            Bit 4 "Integ Lmt Hi" – Indicates the position integrator is at the high limit.            Bit 5 "Spd Lmt Lo" – Indicates the position regulator output (speed) is at the low limit.            Bit 6 "Spd Lmt Hi" – Indicates the position regulator output (speed) is at the high limit.            Bit 7 "Psn Reg Actv" – Indicates the position regulator is active            Bit 8 "Intgrtr Hold" – Indicates the position Integrator is held in present state            Bit 9 "PsnW1Detect" – Indicates the position watch 1 has detected motor position equal to its setpoint, from the proper direction.            Bit 10 "PsnW2Detect" – Indicates the position watch 2 has detected motor position equal to its setpoint, from the proper direction.            Bit 11 "InPsn Detect" – Indicates P835 [Psn Error] is within the position band specified by the in-position band P726 [In Pos Psn Band]</p>		Reserved	Reserved	Reserved	Reserved	Reserved	Reserved	Reserved	Reserved	Reserved	Reserved	Reserved	Reserved	Reserved	Reserved	Reserved	Reserved	Reserved	Reserved	InPsn Detect <sup>(1)</sup>	PsnW2Detect <sup>(1)</sup>	PsnW1Detect <sup>(1)</sup>	Intgrtr Hold	Psn Reg Actv	Spd Lmt Hi	Spd Lmt Lo	Integ Lmt Hi	Integ Lmt Lo	Psn Intgrtr	Offset ReRef	OffsetIntgr	Default	0	0	0	0	0	0	0	0	0	0	0	0	0	0	0	0	0	0	1	0	0	0	0	0	0	0	0	0	0	0	0	Bit	31	30	29	28	27	26	25	24	23	22	21	20	19	18	17	16	15	14	13	12	11	10	9	8	7	6	5	4	3	2	1	0	RO	32-bit Integer
			Reserved	Reserved	Reserved	Reserved	Reserved	Reserved	Reserved	Reserved	Reserved	Reserved	Reserved	Reserved	Reserved	Reserved	Reserved	Reserved	Reserved	Reserved	InPsn Detect <sup>(1)</sup>	PsnW2Detect <sup>(1)</sup>	PsnW1Detect <sup>(1)</sup>	Intgrtr Hold	Psn Reg Actv	Spd Lmt Hi	Spd Lmt Lo	Integ Lmt Hi	Integ Lmt Lo	Psn Intgrtr	Offset ReRef	OffsetIntgr																																																																						
Default	0	0	0	0	0	0	0	0	0	0	0	0	0	0	0	0	0	0	1	0	0	0	0	0	0	0	0	0	0	0	0																																																																							
Bit	31	30	29	28	27	26	25	24	23	22	21	20	19	18	17	16	15	14	13	12	11	10	9	8	7	6	5	4	3	2	1	0																																																																						
725	<b>Zero Position</b> Zero Position Sets the absolute user zero position. When the zero position bit P721 [Position Control] Bit 4 "Zero Psn" is set, P836 [Psn Actual] accumulates the value of P847 [Psn Fdbk] - the P725 [Zero Position], and P836 [Psn Actual] becomes zero when P847 [Psn Fdbk] is at the zero position. The homing function also sets the value after homing process is completed.	Default: 0 Min/Max: -2147483648 / 2147483647	RW	32-bit Integer																																																																																																		
726	<b>In Pos Psn Band</b> In Positive Position Bandwidth Sets the overall bandwidth of the in position detector. The detector sets the in-position detect bit P724 [Psn Reg Status] Bit 11 "InPsn Detect" when P835 [Psn Error] is within this position band for a sufficient time specified by the in-position dwell time P727 [In Pos Psn Dwell]. A modest hysteresis count is added to the position bandwidth after the position error is within specified limits.	Default: 200 Min/Max: 0 / 2147483647	RW	32-bit Integer																																																																																																		

File	Group	No.	Display Name Full Name Description	Values	Read-Write	Data Type																																																				
<b>POSITION CONTROL</b>	<b>Position Cfg/Sts</b>	<b>727</b>	<b>In Pos Psn Dwell</b> In Positive Position Dwell Sets dwell time for the in position detector. Position error must be within the value specified by the in-position band P726 [In Pos Psn Band] for this amount of time before the in-position detector sets the in-position detect bit P724 [Psn Reg Status] Bit 11 "InPsn Detect." A momentary out-of-position indication will reset the internal timer and clear the in-position detect bit P724 [Psn Reg Status] Bit 11 "InPsn Detect."	Default: 0.0040 Min/Max: 0.0001 / 10.0000	RW	Real																																																				
		<b>730</b>	<b>Homing Status</b> Homing Status Indicates status of position control logic.  Options <table border="1" style="margin-left: 20px;"> <tr> <td></td> <td>Reserved</td><td>Reserved</td><td>Reserved</td><td>Reserved</td><td>Reserved</td><td>Reserved</td><td>Reserved</td><td>Reserved</td><td>Reserved</td><td>Reserved</td><td>Reserved</td><td>Reserved</td><td>Reserved</td><td>At Home</td><td>Homing</td><td>Home Enabled</td><td>Home Request</td> </tr> <tr> <td>Default</td> <td>0</td><td>0</td><td>0</td><td>0</td><td>0</td><td>0</td><td>0</td><td>0</td><td>0</td><td>0</td><td>0</td><td>0</td><td>0</td><td>0</td><td>0</td><td>0</td><td>0</td> </tr> <tr> <td>Bit</td> <td>15</td><td>14</td><td>13</td><td>12</td><td>11</td><td>10</td><td>9</td><td>8</td><td>7</td><td>6</td><td>5</td><td>4</td><td>3</td><td>2</td><td>1</td><td>0</td><td></td> </tr> </table> Bit 0 "Home Request" – Indicates the homing function is requested. The homing function is requested by the homing configuration bits in P731 [Homing Control]. This bit turns off when homing is complete. Bit 1 "Home Enabled" – Indicates the homing function is enabled. This bit is set when the homing function is requested and the drive starts. Bit 2 "Homing" – Indicates the drive is heading to home position. This bit is set when the drive is running. Bit 3 "At Home" – Indicates when the difference between P847 [Psn Fdbk] and P737 [Actual Home Psn] is less than P726 [In Pos Psn Band].		Reserved	Reserved	Reserved	Reserved	Reserved	Reserved	Reserved	Reserved	Reserved	Reserved	Reserved	Reserved	Reserved	At Home	Homing	Home Enabled	Home Request	Default	0	0	0	0	0	0	0	0	0	0	0	0	0	0	0	0	0	Bit	15	14	13	12	11	10	9	8	7	6	5	4	3	2	1	0		0 = Disabled 1 = Enabled
	Reserved	Reserved	Reserved	Reserved	Reserved	Reserved	Reserved	Reserved	Reserved	Reserved	Reserved	Reserved	Reserved	At Home	Homing	Home Enabled	Home Request																																									
Default	0	0	0	0	0	0	0	0	0	0	0	0	0	0	0	0	0																																									
Bit	15	14	13	12	11	10	9	8	7	6	5	4	3	2	1	0																																										

File	Group	No.	Display Name Full Name Description	Values	Read-Write	Data Type																																																			
POSITION CONTROL	Position Homing	731	<b>Homing Control</b> Homing Control Sets bits to configure the homing function.  Options <table border="1"> <tr> <td></td> <td>Reserved</td> <td>Reserved</td> <td>Reserved</td> <td>Reserved</td> <td>Reserved</td> <td>Reserved</td> <td>Reserved</td> <td>Home Torque</td> <td>Hold At Home</td> <td>Home DI Inv</td> <td>Homing Alarm</td> <td>Psn Redefine</td> <td>Return Home</td> <td>Home Marker</td> <td>Home DI</td> <td>Find Home</td> </tr> <tr> <td>Default</td> <td>0</td> <td>0</td> <td>0</td> <td>0</td> <td>0</td> <td>0</td> <td>0</td> <td>0</td> <td>0</td> <td>1</td> <td>0</td> <td>0</td> <td>0</td> <td>0</td> <td>0</td> <td>0</td> </tr> <tr> <td>Bit</td> <td>15</td> <td>14</td> <td>13</td> <td>12</td> <td>11</td> <td>10</td> <td>9</td> <td>8</td> <td>7</td> <td>6</td> <td>5</td> <td>4</td> <td>3</td> <td>2</td> <td>1</td> <td>0</td> </tr> </table> 0 = Disabled 1 = Enabled  <b>Important:</b> To enable the homing control, Bit 1 or Bit 2 (configuration bits) must be set to go into the Find Home mode. With the drive stopped, verify that a stop command has not been issued and toggle Bit 0 to 1. The drive will go to the home position at the ensuing startup. Bit 0 "Find Home" – Puts the drive in the homing mode. Setting this bit requests the homing function and sets homing request bit P730 [Homing Status] Bit 0 "Home Request." Toggle this bit with the drive stopped to reset the homing function. If the drive is issued a stop command while in Find Home mode, and before the At Home limit switch is reached, toggle this bit to put the drive back in Find Home mode. Once the At Home limit switch is hit, whether it is wired to the encoder option or a digital input, the drive will revert to mode selected by P313 [Actv SpTqPs Mode]. Movement may result. Bit 1 "Home DI" – Configures the homing function to use a switch (digital input). When this bit is on and Bit 2 "Home Marker" is off, the homing function is configured as home switch mode. When this bit is on and Bit 2 "Home Marker" is on, the homing function is configured as home marker-switch mode. Bit 2 "Home Marker" – Configures the homing function to use a marker input. When this bit is on and Bit 1 "Home DI" is off, the homing function is configured as home marker mode. When this bit is on and Bit 1 "Home DI" is on, the homing function is configured as home marker-switch mode. When using this function verify that the Z Channel of the encoder module is enabled (Bit 0 "Z Chan Enbl" = 1). Bit 3 "Return Home" – Configures the homing function as return to home through software. The drive returns to the actual home position set by P737 [Actual Home Psn]. A start command is required to set this bit. Same as other homing mode, the drive will resume normal operation after the return home procedure. Bit 4 "Psn Redefine" – Sets the position feedback P847 [Psn Fdbk] to the actual home position P737 [Actual Home Psn]. Bit 5 "Homing Alarm" – Enables the home running alarm when the homing function is active. Bit 6 "Home DI Inv" – Changes polarity of the switch input (digital input). Bit 7 "Hold At Home" – Configures the drive to hold the home position after completing the homing function. A new start command is required for the drive to resume normal operation. Bit 8 "Home Torque" – Configures the homing function to return home based on a hard stop detection. The drive returns to the home position set by P739 [Home Trq Thresh] and P740 [Home Trq Time].		Reserved	Reserved	Reserved	Reserved	Reserved	Reserved	Reserved	Home Torque	Hold At Home	Home DI Inv	Homing Alarm	Psn Redefine	Return Home	Home Marker	Home DI	Find Home	Default	0	0	0	0	0	0	0	0	0	1	0	0	0	0	0	0	Bit	15	14	13	12	11	10	9	8	7	6	5	4	3	2	1	0		RW	16-bit Integer
			Reserved	Reserved	Reserved	Reserved	Reserved	Reserved	Reserved	Home Torque	Hold At Home	Home DI Inv	Homing Alarm	Psn Redefine	Return Home	Home Marker	Home DI	Find Home																																							
		Default	0	0	0	0	0	0	0	0	0	1	0	0	0	0	0	0																																							
		Bit	15	14	13	12	11	10	9	8	7	6	5	4	3	2	1	0																																							
		732	<b>DI Find Home</b> Digital Input Find Home Sets a digital input port for the "Find Home" function. After P731 [Homing Control] Bit 0 "Find Home" is set, a start command is required.	Default: 0.00 Min/Max: 0.00 / 159999.15	RW	32-bit Integer																																																			
		733	<b>DI Redefine Psn</b> Digital Input Redefine Position Sets a digital input port for the redefine position function. The digital input assigned by this parameter is equivalent to P731 [Homing Control] Bit 4 "Psn Redefine."	Units: 0.00 Min/Max: 0.00 / 159999.15	RW	32-bit Integer																																																			
734	<b>DI OL Home Limit</b> Digital Input Open Loop Home Limit Sets a digital input port for the limit switch of open loop homing function. Polarity of digital input (rising or falling edge) is specified by P731 [Homing Control] Bit 6 "Home DI Inv."	Units: 0.00 Min/Max: 0.00 / 159999.15	RW	32-bit Integer																																																					
735	<b>Find Home Speed</b> Find Home Speed Sets the speed and direction that are active when P731 [Homing Control] Bit 0 "Find Home" is active. The sign of the value defines direction ("+" = Forward, "-" = Reverse). If set to a negative value, verify that parameter 308 [Direction Mode] is set to 1 "Bipolar."	Units: Hz RPM Default: P27 [Motor NP Hz] x 0.1 P28 [Motor NP RPM] x 0.1 Min/Max: P27 [Motor NP Hz] x 0.5 P28 [Motor NP RPM] x 0.5	RW	Real																																																					
736	<b>Find Home Ramp</b> Find Home Ramp Sets the rate of acceleration and deceleration of the Find Home moves.	Units: Secs Default: 10.00 Min/Max: 0.01 / 6554.00	RW	Real																																																					

File	Group	No.	Display Name Full Name Description	Values		Read-Write	Data Type
				Default:	Min/Max:		
POSITION CONTROL	Position Homing	737	<b>Actual Home Psn</b> Actual Home Position Indicates actual home position after the homing function is complete. The value in this parameter displays the raw position feedback data at home position.	Default: 0 Min/Max: -2147483648 / 2147483647		RW	32-bit Integer
		738	<b>User Home Psn</b> User Home Position Sets user-defined home position. After the homing function is completed, the following parameters are updated with this parameter value; P723 [Psn Command], P815 [Psn Ref EGR Out], P836 [Psn Actual], P837 [Psn Load Actual].	Default: 0 Min/Max: -2147483648 / 2147483647		RW	32-bit Integer
		739	<b>Home Trq Thresh</b> Home Torque Threshold Sets the minimum torque level needed to detect the hard stop during a Home to Torque sequence. The drive's output torque must exceed the specified Home Torque Threshold for the specified Home Torque Time. The units for Home Torque Threshold are expressed as a percentage of the operative Torque Limit, which during the homing sequence is set to the Home Torque Limit of the controller.	Units: % Default: 15.00 Min/Max: 0.00 / 100.00		RW	Real
		740	<b>Home Trq Time</b> Home Torque Time Sets the minimum amount of time needed for the drive's output torque to exceed the specified Home Torque Threshold to detect the hard stop during a Home to Torque sequence. Zero will disable the home to torque sequence.	Units: Secs Default: 1.0 Min/Max: 0.0 / 10.0		RW	Real
		741	<b>Home Trq Level</b> Home Torque Level The Home Torque Level attribute contains the value of the torque limit when using one of the torque homing modes. The units for the Torque Level will be "% continuous torque" of the motor limited by the drive-rated current/motor-rated current ratio.	Units: % Default: 20 Min/Max: 0.00 / 100		RW	Real
		742	<b>Home Torq Offset</b> Home Torque Offset Determines the distance between the homing event position and the home position. Not valid for "immediate" Home Sequence.	Default: 0 Min/Max: -214783648 / 214783648		RW	Real
		743	<b>Home Return Spd</b> Home Return Speed Final speed of an active homing sequence either returning to the home switch or home position. Return direction is always opposite of Home Spd.	Units: Hz or RPM Default: P27 [Motor NP Hz] / 100 Min/Max: +P27 [Motor NP Hz] * 0.5 / 0.0		RW	Real
		744	<b>Home Decel</b> Home Deceleration Deceleration of an active homing sequence.	Units: secs Default: 10.0 Min/Max: 0.01 / 6554.00		RW	Real

File	Group	No.	Display Name Full Name Description	Values	Read-Write	Data Type
POSITION CONTROL	Position Watch	745	<b>755 PsnWatch1 Select</b> Position Watch <i>n</i> Select	Default: 847	RW	32-bit Integer
		748	<b>755 PsnWatch2 Select</b> Position Watch <i>n</i> Select Selects a position feedback source that is compared to the position watch detect-input P746 [PsnWatch1 Dtctln], P749 [PsnWatch2 Dtctln].	Min/Max: 1 / 159999	RW	32-bit Integer
		746	<b>755 PsnWatch1 Dtctln</b> Position Watch <i>n</i> Detect Input	Default: 0	RW	32-bit Integer
		749	<b>755 PsnWatch2 Dtctln</b> Position Watch <i>n</i> Detect Input Provides position feedback source for the position watch function. The position watch function is enabled and configured by the position control configuration P721 [Position Control]. The position watch function compares this value to the position watch set point P747 [PsnWatch1 Stpt], P750 [PsnWatch2 Stpt] when this parameter P746, P749 is selected by the position watch select P745 [PsnWatch1 Select], P748 [PsnWatch2 Select]. The position detect bit P724 [Psn Reg Status] Bit 9 "PsnW1Detect", Bit 10 "PsnW2Detect" is set when the appropriate condition is satisfied.	Min/Max: -2147483648 / 2147483647	RW	32-bit Integer
		747	<b>755 PsnWatch1 Stpt</b> Position Watch <i>n</i> Setpoint	Default: 0	RW	32-bit Integer
		750	<b>755 PsnWatch2 Stpt</b> Position Watch <i>n</i> Setpoint Provides set point for the position watch function. The position watch function is enabled and configured by P721 [Position Control]. The position watch function compares this value to the position feedback source selected by the position watch select P745 [PsnWatch1 Select], P748 [PsnWatch2 Select]. The position detect bit P724 [Psn Reg Status] Bit 9 "PsnW1Detect", Bit 10 "PsnW2Detect" is set when the appropriate condition is satisfied.	Min/Max: -2147483648 / 2147483647	RW	32-bit Integer

File	Group	No.	Display Name Full Name Description	Values	Read-Write	Data Type
POSITION CONTROL	Interpolator	755	<b>755 Interp Control</b> Interpolator Control Reserved for future use.	Default: 0 Options: 1 / 2147483647	RW	32-bit Integer
		756	<b>755 Interp Psn Input</b> Interpolator Position Input Input value to the Command Position fine interpolator.	Default: 0 Min/Max: -2147483648 / 2147483647	RW	32-bit Integer
		757	<b>755 Interp Vel Input</b> Interpolator Velocity Input Input value to the Command Velocity fine interpolator.	Units: Hz RPM Default: 0.00 Min/Max: -/+1000000.00	RW	Real
		758	<b>755 Interp Trq Input</b> Interpolator Torque Input Input value to the Command Torque fine interpolator.	Default: 0.00 Min/Max: -/+1000000.00	RW	Real
		759	<b>755 Interp Psn Out</b> Interpolator Position Output Output value from the Command Position fine interpolator.	Default: 0 Min/Max: -2147483648 / 2147483647	RO	32-bit Integer
		760	<b>755 Interp Vel Out</b> Interpolator Velocity Output Output value from the Command Velocity fine interpolator. When no Command Velocity signal is present when performing position control, this signal can be derived by scaling the Differential Position output value of the Command Position fine interpolator.	Units: Hz RPM Default: 0.00 Min/Max: -/+1000000.00	RO	Real
		761	<b>755 Interp Trq Out</b> Interpolator Torque Output Command torque output from fine interpolator (if active) into torque input summing junction when configured for torque control.	Default: 0.00 Min/Max: -/+1000000.00	RO	Real




File	Group	No.	Display Name Full Name Description	Values		Read-Write	Data Type
				Default:	Options:		
POSITION CONTROL	Direct	765	<b>Psn Ref Select</b> Position Reference Select Selects a position reference to the position regulator when P313 [Actv SpTqPs Mode] is set to 10 "Psn Direct."	Default: 766 Options: 1 / 159999		RW	32-bit Integer
		766	<b>Psn Direct Stpt</b> Position Direct Setpoint Provides a set point for the direct position reference and a position reference to the position regulator when P313 [Actv SpTqPs Mode] is set to 10 "Psn Direct" and P765 [Psn Ref Select] is set to this parameter.	Default: 0 Min/Max: -2147483648 / 2147483647		RW	32-bit Integer
		767	<b>Psn Direct Ref</b> Position Direct Reference Indicates the position direct reference selected by P765 [Psn Ref Select].	Default: 0 Min/Max: -2147483648 / 2147483647		RO	32-bit Integer

File	Group	No.	Display Name Full Name Description	Values	Read-Write	Data Type																																																			
POSITION CONTROL	Point to Point	770	<b>PTP Control</b> Point-To-Point Control Sets bits to configure the point-to-point position control. Options <table border="1" style="margin-left: 20px;"> <tr> <td></td> <td>Reserved</td> <td>Reserved</td> <td>Reserved</td> <td>Reserved</td> <td>Reserved</td> <td>Reserved</td> <td>Reserved</td> <td>Reserved</td> <td>Reserved</td> <td>Ref Sync</td> <td>Ref Pause</td> <td>Intgrtr Hold</td> <td>Preset Psn</td> <td>Reverse Move</td> <td>Move</td> <td>Vel Override</td> </tr> <tr> <td>Default</td> <td>0</td> <td>0</td> <td>0</td> <td>0</td> <td>0</td> <td>0</td> <td>0</td> <td>0</td> <td>0</td> <td>0</td> <td>0</td> <td>0</td> <td>0</td> <td>0</td> <td>0</td> <td>0</td> </tr> <tr> <td>Bit</td> <td>15</td> <td>14</td> <td>13</td> <td>12</td> <td>11</td> <td>10</td> <td>9</td> <td>8</td> <td>7</td> <td>6</td> <td>5</td> <td>4</td> <td>3</td> <td>2</td> <td>1</td> <td>0</td> </tr> </table> 0 = False 1 = True		Reserved	Reserved	Reserved	Reserved	Reserved	Reserved	Reserved	Reserved	Reserved	Ref Sync	Ref Pause	Intgrtr Hold	Preset Psn	Reverse Move	Move	Vel Override	Default	0	0	0	0	0	0	0	0	0	0	0	0	0	0	0	0	Bit	15	14	13	12	11	10	9	8	7	6	5	4	3	2	1	0		RW	16-bit Integer
			Reserved	Reserved	Reserved	Reserved	Reserved	Reserved	Reserved	Reserved	Reserved	Ref Sync	Ref Pause	Intgrtr Hold	Preset Psn	Reverse Move	Move	Vel Override																																							
		Default	0	0	0	0	0	0	0	0	0	0	0	0	0	0	0	0																																							
		Bit	15	14	13	12	11	10	9	8	7	6	5	4	3	2	1	0																																							
		771	<b>PTP Mode</b> Point-To-Point Mode Selects point-to-point position mode. The point-to-point position control is configured with the following selections. "Absolute" (0) – Selects absolute position mode. When P770 [PTP Control] Bit 1 "Move" is set, the reference source, selected by P775 [PTP Ref Sel], is multiplied by P778 [PTP Ref Scale] and P784 [PTP Command] is set by the result. "Index" (1) – Selects index position mode. When P770 [PTP Control] Bit 1 "Move" is set, the reference source, selected by P775 [PTP Ref Sel], is multiplied by P778 [PTP Ref Scale] and P784 [PTP Command] is incremented by the result. "Immediate" (2) – Selects absolute immediate position mode. When P770 [PTP Control] Bit 1 "Move" is set, and the reference source selected by P775 [PTP Ref Sel] changes, P784 [PTP Command] is immediately set.	Default: 0 = "Absolute" Options: 0 = "Absolute" 1 = "Index" 2 = "Immediate"	RW	32-bit Integer																																																			
772	<b>DI Indx Step</b> Digital Input Index Step Sets a digital input port for the index position move. The digital input assigned by this parameter is equivalent to the point-to-point move bit P770 [PTP Control] Bit 1 "Move" when the point-to-point mode P771 [PTP Mode] is set to 0 "Absolute" or 1 "Index."	Default: 0.00 Min/Max: 0.00 / 159999.15	RW	32-bit Integer																																																					
773	<b>DI Indx StepRev</b> Digital Input Index Step Reverse Sets a digital input port for the index position reverse move. The digital input assigned by this parameter is equivalent to the point-to-point reverse move bit P770 [PTP Control] Bit 2 "Reverse Move" when the point-to-point mode P771 [PTP Mode] is selected to the index position mode (Option 1).	Default: 0.00 Min/Max: 0.00 / 159999.15	RW	32-bit Integer																																																					
774	<b>DI Indx StepPrst</b> Digital Input Index Step Preset Sets a digital input port for the index preset position. The digital input assigned by this parameter is equivalent to the point-to-point preset position bit P770 [PTP Control] Bit 3 "Preset Psn" when the point-to-point mode P771 [PTP Mode] is selected to the index position mode (Option 1).	Default: 0.00 Min/Max: 0.00 / 159999.15	RW	32-bit Integer																																																					

File	Group	No.	Display Name Full Name Description	Values		Read-Write	Data Type
POSITION CONTROL	Point to Point	775	<b>PTP Ref Sel</b>  Point-To-Point Reference Select Selects a point-to-point reference source that applies to the point-to-point position control.	Default: 780 Min/Max: 1 / 159999		RW	32-bit Integer
		776	<b>PTP Reference</b> Point-To-Point Reference Indicates output of the point-to-point position control as a reference of the position control. When the speed/torque/position mode P313 [Actv SpTqPs Mode] is selected to the point-to-point mode (Option 7) or the profiler mode (Option 6), this parameter value appears on the position selected reference P722 [Psn Selected Ref].	Default: 0 Min/Max: -2147483648 / 2147483647		RO	32-bit Integer
		777	<b>PTP Feedback</b> Point-To-Point Feedback Indicates position feedback in the point-to-point position control.	Default: 0 Min/Max: -2147483648 / 2147483647		RO	32-bit Integer
		778	<b>PTP Ref Scale</b> Point-To-Point Reference Scale Provides count per scale value for the point-to-point position reference. The value is a multiplier for the point-to-point reference source selected by the reference selection P775 [PTP Ref Sel].	Default: 1.00 Min/Max: -/+220000000.00		RW	Real
		779	<b>PTP Index Preset</b> Point-To-Point Index Preset Provides pre-set index value. The value sets to the point-to-point position command P784 [PTP Command] when the point-to-point mode is index mode P771 [PTP Mode] and the preset position bit P770 [PTP Control] Bit 3 "Preset Psn" is on.	Default: 0 Min/Max: -2147483648 / 2147483647		RW	32-bit Integer
		780	<b>PTP Setpoint</b> Point-To-Point Setpoint Provides set point for the point-to-point position control. The value applies to the point-to-point control when the point-to-point reference selection P775 [PTP Ref Sel] is P780. When P771 [PTP Mode] is set to 1 "Index," the value of this parameter represents the amount of index.	Default: 0 Min/Max: -2147483648 / 2147483647		RW	32-bit Integer
		781	<b>PTP Accel Time</b> Point-To-Point Acceleration Time Provides the ramp time for acceleration (time to go from zero to speed limit). The speed limit is set by P785 [PTP Fwd Vel Lmt] and P786 [PTP Rev Vel Lmt].	Units: Secs Default: 10.00 Min/Max: 0.00 / 3600.00		RW	Real
		782	<b>PTP Decel Time</b> Point-To-Point Deceleration Time Provides the ramp time for deceleration (time to go from speed limit to zero). The speed limit is set by P785 [PTP Fwd Vel Lmt] and P786 [PTP Rev Vel Lmt].	Units: Secs Default: 10.00 Min/Max: 0.00 / 3600.00		RW	Real
		783	<b>PTP Speed FwdRef</b> Point-To-Point Speed Forward Reference Indicates speed reference output from the point-to-point position control. Typically this parameter is used by the drive speed loop.	Units: Hz RPM Default: 0.00 Min/Max: -/+P27 [Motor NP Hertz] x 8 -/+P28 [Motor NP RPM] x 8		RO	Real
		784	<b>PTP Command</b> Point-To-Point Command Indicates position command for the point-to-point position control. The source of the position command is selected by the speed/torque/position mode P313 [Actv SpTqPs Mode].	Default: 0 Min/Max: -2147483648 / 2147483647		RO	32-bit Integer
		785	<b>PTP Fwd Vel Lmt</b> Point-To-Point Forward Velocity Limit Provides the maximum forward speed reference limit from the PTP regulator.	Units: Hz RPM Default: P27 [Motor NP Hertz] x 0.5 P28 [Motor NP RPM] x 0.5 Min/Max: 0.00/P27 [Motor NP Hertz] 0.00/P28 [Motor NP RPM] x 8		RW	Real



File	Group	No.	Display Name Full Name Description	Values	Read-Write	Data Type
POSITION CONTROL	Point to Point	786	<b>PTP Rev Vel Lmt</b> Point-To-Point Reverse Velocity Limit Provides the maximum reverse speed reference limit from the PTP regulator.	Units: Hz RPM Default: P27 [Motor NP Hertz] x 0.5 P28 [Motor NP RPM] x 0.5 Min/Max: - P27 [Motor NP Hertz] P28 [Motor NP RPM] x 8 / 0.00	RW	Real
		787	<b>PTP S Curve</b> Point-To-Point S Curve Provides the amount of time that is applied to the S Curve from the PTP regulator.	Units: Secs Default: 0.500 Min/Max: 0.000 / 4.000	RW	Real
		788	<b>PTP Vel Override</b> Point-To-Point Velocity Override Provides multiplier to both forward P785 [PTP Fwd Vel Lmt] and reverse P786 [PTP Rev Vel Lmt] speed limits. This parameter applies to the speed limits when the override bit P770 [PTP Control] Bit 0 "Vel Override" is on.	Default: 1.00 Min/Max: 0.20 / 1.50	RW	Real
		789	<b>PTP EGR Mult</b> Point-To-Point Electronic Gear Ratio Multiply EGR multiplier (numerator) for position index output. The output applies to the point-to-point command P784 [PTP Command].	Default: 1 Min/Max: -/+2000000	RW	32-bit Integer
		790	<b>PTP EGR Div</b> Point-To-Point Electronic Gear Ratio Divide EGR divider (denominator) for position index output. The output applies to the point-to-point command P784 [PTP Command].	Default: 1 Min/Max: 1 / 2000000	RW	32-bit Integer

File	Group	No.	Display Name Full Name Description	Values	Read-Write	Data Type																																																			
POSITION CONTROL	Phase Lock Loop	795	<b>755 PLL Control</b> Phase Locked Loop Control Sets bits to configure the phase locked loop control.  Options <table border="1" style="display: inline-table; vertical-align: top;"> <tr> <td></td> <td>Reserved</td> <td>Reserved</td> <td>Reserved</td> <td>Reserved</td> <td>Reserved</td> <td>Reserved</td> <td>Reserved</td> <td>Reserved</td> <td>Reserved</td> <td>Prof Enable</td> <td>PTP Enable</td> <td>PCAM Enable</td> <td>Accel Comp</td> <td>Ext Vel FF</td> <td>Velocity FF</td> <td>PLL Enable</td> </tr> <tr> <td>Default</td> <td>0</td> <td>0</td> <td>0</td> <td>0</td> <td>0</td> <td>0</td> <td>0</td> <td>0</td> <td>0</td> <td>0</td> <td>0</td> <td>0</td> <td>0</td> <td>0</td> <td>0</td> <td>0</td> </tr> <tr> <td>Bit</td> <td>15</td> <td>14</td> <td>13</td> <td>12</td> <td>11</td> <td>10</td> <td>9</td> <td>8</td> <td>7</td> <td>6</td> <td>5</td> <td>4</td> <td>3</td> <td>2</td> <td>1</td> <td>0</td> </tr> </table> 0 = False 1 = True  Bit 0 "PLL Enable" – enables the phase locked loop control. Bit 1 "Velocity FF" – enables the velocity feed forward path. Bit 2 "Ext Vel FF" – enables the external velocity feed forward through the PLL external speed reference selected by the PLL external speed selection P796 [PLL Ext Spd Sel]. Bit 3 "Accel Comp" – enables providing an element of acceleration compensation to the feed forward branch. This is not recommended for use with external inputs because of increased noise. Bit 4 "PCAM Enable" – enables PCAM function with the PLL function. Bit 5 "PTP Enable" – enables point-to-point function with the PLL function. Bit 6 "Prof Enable" – enables profiler function with the PLL function. Only bits 4, 5, and 6 allow associating with the PLL function.		Reserved	Reserved	Reserved	Reserved	Reserved	Reserved	Reserved	Reserved	Reserved	Prof Enable	PTP Enable	PCAM Enable	Accel Comp	Ext Vel FF	Velocity FF	PLL Enable	Default	0	0	0	0	0	0	0	0	0	0	0	0	0	0	0	0	Bit	15	14	13	12	11	10	9	8	7	6	5	4	3	2	1	0		RW	16-bit Integer
			Reserved	Reserved	Reserved	Reserved	Reserved	Reserved	Reserved	Reserved	Reserved	Prof Enable	PTP Enable	PCAM Enable	Accel Comp	Ext Vel FF	Velocity FF	PLL Enable																																							
Default	0	0	0	0	0	0	0	0	0	0	0	0	0	0	0	0																																									
Bit	15	14	13	12	11	10	9	8	7	6	5	4	3	2	1	0																																									
796	<b>755 PLL Ext Spd Sel</b> Phase Locked Loop External Speed Select Selects an external speed reference source.	Default: 797 Options: 1 / 159999	RW	32-bit Integer																																																					

File	Group	No.	Display Name Full Name Description	Values		Read-Write	Data Type
				Default:	Min/Max:		
POSITION CONTROL	Phase Lock Loop	797	<b>755 PLL Ext Spd Stpt</b> Phase Locked Loop External Speed Setpoint Provides external speed reference. This parameter is a velocity feed forward input that is selected by the external speed select P796 [PLL Ext Spd Sel].	Default: 0.00 Min/Max: -/+220000000.00		RW	Real
		798	<b>755 PLL Ext SpdScale</b> Phase Locked Loop External Speed Scale Sets scale factor to the external speed reference selected by the external speed select P796 [PLL Ext Spd Sel]. This parameter is used to properly scale the velocity feed forward. Adjust for zero average at the filtered position output P806 [PLL Psn Out Fltr] while running at moderate speed.	Default: 1.00 Min/Max: -/+220000000.00		RW	Real
		799	 <b>755 PLL Psn Ref Sel</b> Phase Locked Loop Position Reference Select Selects a position reference source.	Default: 800 Min/Max: 1 / 159999		RW	32-bit Integer
		800	<b>755 PLL Psn Stpt</b> Phase Locked Loop Position Setpoint Provides position reference when the position reference select P799 [PLL Psn Ref Sel] selects this parameter.	Default: 0 Min/Max: -2147483648 / 2147483647		RW	32-bit Integer
		801	<b>755 PLL BW</b> Phase Locked Loop Bandwidth Sets internal bandwidth of the PLL function response. The setting for very noisy mechanical systems could range from 1 to 10 (r/s) while well-behaved high line count input devices could range upwards of 100 (r/s). Higher bandwidths will quickly resolve tracking errors while the lower bandwidths will take longer to settle into a steady state. Some adjustment will be necessary for the best compromise between noise and tracking response.	Units: R/S Default: 20.00 Min/Max: 0.00 / 8000.00		RW	Real
		802	<b>755 PLL LPFilter BW</b> Phase Locked Loop Low Pass Filter Bandwidth Sets low pass filter bandwidth. The filter has two functions: <ul style="list-style-type: none"> <li>Basic noise reduction of input velocity.</li> <li>Timed delay of input when feed forward is provided to an external master reference other than an input encoder.</li> </ul> The filter low pass bandwidth should be set for best tracking which occurs when the filter output coincides with the loop filter output of PLL. Usually that means setting its bandwidth to the bandwidth of the master reference drive.	Units: R/S Default: 50.00 Min/Max: 0.00 / 8000.00		RW	Real
		803	<b>755 PLL Virt Enc RPM</b> Phase Locked Loop Virtual Encoder Revolutions Per Minute Sets RPM of the virtual output device. The value determines the 1 P.U. velocity for the speed out P807 [PLL Speed Out] and does not affect performance.	Units: RPM Default: 1750.00 Min/Max: 1.00 / 40000.00		RW	Real
		804	<b>755 PLL EPR Input</b> Phase Locked Loop Edges Per Revolution Input Sets edges per revolution of the physical input device. Using the highest line count device possible smooths PLL operation.	Default: 1048576 Min/Max: 1 / 67108864		RW	32-bit Integer
		805	<b>755 PLL Rvls Input</b> Phase Locked Loop Revolutions Input Sets revolution of the input encoder. This parameter must be coordinated with the revolution of the output encoder P812 [PLL Rvls Output] to resolve the gear-ratio between input revolutions and output (virtual) revolutions. The ratio of input to output revolutions can always be resolved into integer values and should be reduced to their lowest common factor.	Default: 1 Min/Max: 1 / 1000000		RW	32-bit Integer

File	Group	No.	Display Name Full Name Description	Values	Read-Write	Data Type
POSITION CONTROL	Phase Lock Loop	806	<b>755 PLL Psn Out Fitr</b> Phase Locked Loop Position Output Filter Indicates internal low pass filter output. This parameter is normally used to properly scale an external velocity reference. See description of the external speed scale P798 [PLL Ext SpdScale].	Default: 0.00 Min/Max: -/+220000000.00	RO	Real
		807	<b>755 PLL Speed Out</b> Phase Locked Loop Speed Output Indicates velocity output. This parameter is used as a velocity feed forward. It is precisely in phase with the physical input device. The virtual encoder RPM P803 [PLL Virt Enc RPM] determines the RPM at 1 P.U. of this parameter.	Default: 0.00 Min/Max: -/+220000000.00	RO	Real
		808	<b>755 PLL Speed OutAdv</b> Phase Locked Loop Speed Output Advanced Indicates velocity advanced output. This parameter is one velocity reference sample in advance of the speed output P807 [PLL Speed Out].	Default: 0.00 Min/Max: -/+220000000.00	RO	Real
		809	<b>755 PLL Enc Out</b> Phase Locked Loop Encoder Output Indicates position output. This parameter is precisely in phase with the input physical device.	Default: 0 Min/Max: -2147483648 / 2147483647	RO	32-bit Integer
		810	<b>755 PLL Enc Out Adv</b> Phase Locked Loop Encoder Output Advanced Indicates position advanced output. This parameter is one position sample in advance of the position output P809 [PLL Enc Out].	Default: 0 Min/Max: -2147483648 / 2147483647	RO	32-bit Integer
		811	<b>755 PLL EPR Output</b> Phase Locked Loop Edges Per Revolution Output Sets edges per revolution of the physical output device.	Default: 1048576 Min/Max: 1 / 67108864	RW	32-bit Integer
		812	<b>755 PLL Rvls Output</b> Phase Locked Loop Revolutions Output Sets revolution of the output encoder. This parameter must be coordinated with the revolution of the input encoder P805 [PLL Rvls Input] to resolve the gear-ratio between input revolutions and output (virtual) revolutions. The ratio of input to output revolutions can always be resolved into integer values and should be reduced to their lowest common factor.	Default: 1 Min/Max: 1 / 2000000	RW	32-bit Integer

File	Group	No.	Display Name Full Name Description	Values	Read-Write	Data Type
POSITION CONTROL	Electronic Gear	815	<b>Psn Ref EGR Out</b> Position Reference Electronic Gear Ratio Output Indicates accumulated output of the position reference electronic gear ratio (EGR) function. When the position regulator is not enabled, this parameter is initialized to P836 [Psn Actual].	Default: 0 Min/Max: -2147483648 / 2147483647	RO	32-bit Integer
		816	<b>Psn EGR Mult</b> Position Electronic Gear Ratio Multiplier Sets integer value in the numerator of the EGR function that is precision multiplied by the position reference. A negative value will effect a change in polarity.	Default: 1 Min/Max: -/+2000000	RW	32-bit Integer
		817	<b>Psn EGR Div</b> Position Electronic Gear Ratio Division Sets integer value in the denominator of the EGR function that divides into the product of the numerator and the position reference. Remainders are accumulated and not lost.	Default: 1 Min/Max: 1 / 2000000	RW	32-bit Integer


File	Group	No.	Display Name Full Name Description	Values	Read-Write	Data Type
POSITION CONTROL	Position Offset	820	<b>Psn Offset 1 Sel</b>  Position Offset 1 Select Selects a Position Offset 1 source.	Default: 821 Min/Max: 1 / 159999	RW	32-bit Integer
		821	<b>Psn Offset 1</b> Position Offset 1 Provides position reference offset, which is summed after the EGR and used to trim the phase of the position reference. A step in the offset position will be internally rate limited and added to the reference position. The rate of correction is set by the offset velocity P824 [Psn Offset Vel]. The initial value of this parameter is latched upon position enable without causing a change in reference. Subsequent changes to this value will be relative to the latched value. See the offset re-referencing bit P721 [Position Control] Bit 2 "Offset ReRef."	Default: 0 Min/Max: -2147483648 / 2147483647	RW	32-bit Integer
		822	<b>Psn Offset 2 Sel</b>  Position Offset 2 Select Selects a Position Offset 2 source.	Default: 823 Min/Max: 1 / 159999	RW	32-bit Integer
		823	<b>Psn Offset 2</b> Position Offset 2 Select Provides another position reference offset, which is summed with P821 [Psn Offset 1] and used to trim the phase of the position reference. The rate of correction is set by the offset velocity P824 [Psn Offset Vel].	Default: 0 Min/Max: -2147483648 / 2147483647	RW	32-bit Integer
		824	<b>Psn Offset Vel</b> Position Offset Velocity Sets speed of position offset. A position offset command will not exceed this speed. The actual speed of offset is limited to a maximum value of $1/(\text{inertia} \times \text{pos gain})$ so as not to cause a torque pulse greater than 1 per unit. The speed will change exponentially.	Units: Hz RPM Default: P27 [Motor NP Hertz] x 0.005 P28 [Motor NP RPM] x 0.005 Min/Max: -/+P27 [Motor NP Hertz] -/+P28 [Motor NP RPM] x 8	RW	Real

File	Group	No.	Display Name Full Name Description	Values	Read-Write	Data Type
POSITION CONTROL	Ld Psn Fdbk Scal	825	<b>755 LdPsn Fdbk Mult</b> Load Position Feedback Multiplier Sets numerator of the load EGR function. It is multiplied by the position load feedback selected by the load feedback select P136 [Load Psn FdbkSel] and divided by the load feedback divider P826 [LdPsn Fdbk Div] to reflect the load pulse count to the motor (effectively removing the gear box ratio). The accumulated position values P836 [Psn Actual] and the position load actual P837 [Psn Load Actual] - will be equal if the ratio is set properly. There may be some difference due to lost motion in the gear train, but there should not be an accumulated difference. It is often necessary to count gear teeth as gear box manufacturers often approximate exact ratios with decimal numbers. Enter a negative value in the numerator to account for reversed motor rotation.	Default: 1 Min/Max: -/+1000000	RW	32-bit Integer
		826	<b>755 LdPsn Fdbk Div</b> Load Position Feedback Division Sets denominator of the load EGR function.	Default: 1 Min/Max: 1 / 2000000	RW	32-bit Integer

File	Group	No.	Display Name Full Name Description	Values		Read-Write	Data Type
POSITION CONTROL	Position Reg	830	<b>PsnNtchFltrFreq</b> Position Notch Filter Frequency Sets the center frequency of the position notch filter.	Units: Default: Min/Max:	Hz 0.00 0.00 / 500.00	RW	Real
		831	<b>PsnNtchFltrDepth</b> Position Notch Filter Depth Sets the depth for the position notch filter. Attenuation is the ratio of the output to the input at the notch frequency P830 [PsnNtchFltrFreq]. The attenuation of 30 means that the notch output is 1/30th of the input at the specified frequency. Calculation: Attenuation = Input / Output	Default: Min/Max:	50.00 0.00 / 500.00	RW	Real
		832	<b>Psn Out Fltr Sel</b> Position Output Filter Select Selects a type of lead-lag filter for position regulator speed output. This parameter sets filter gain P833 [Psn Out FltrGain] and bandwidth P834 [Psn Out Fltr BW] according to the selected type. "Off" (0) – P833 = 1.000, P834 = 0.00 "Custom" (1) – P833 = user setting, P834 = user setting	Default: Options:	0 = "Off" 0 = "Off" 1 = "Custom"	RW	32-bit Integer
		833	<b>Psn Out FltrGain</b> Position Output Filter Gain Sets lead-lag filter gain. A default value is sets when the filter type selection P832 [Psn Out Fltr Sel] is not Custom (Option 1). See the filter type selection P832.	Default: Min/Max:	3.000 -/ +5.000	RW	Real
		834	<b>Psn Out Fltr BW</b> Position Output Filter Bandwidth Sets lead-lag bandwidth. A default value is sets when the filter type selection P832 [Psn Out Fltr Sel] is not Custom (Option 1). See the filter type selection P832.	Units: Default: Min/Max:	R/S 50.00 0.00 / 500.00	RW	Real
		835	<b>Psn Error</b> Position Error Indicates actual position error in motor pulse counts as a 32-bit integer. When the position regulator is not enabled, the value is initialized to zero. When the position regulator is enabled, the value contains the running value of position error between the position command P723 [Psn Command] and P836 [Psn Actual].	Default: Min/Max:	0 -2147483648 / 2147483647	RO	32-bit Integer
		836	<b>Psn Actual</b> Position Actual Indicates accumulated motor position as a 32-bit integer. It tracks the position feedback P847 [Psn Fdbk]. When P721 [Position Control] Bit 4 "Zero Psn" is set, this parameter accumulates the value of P847 [Psn Fdbk] - the P725 [Zero Position]. When P721 [Position Control] Bit 4 "Zero Psn" is off, this parameter accumulates the value of P847 [Psn Fdbk].	Default: Min/Max:	0 -2147483648 / 2147483647	RO	32-bit Integer



File	Group	No.	Display Name Full Name Description	Values	Read-Write	Data Type
POSITION CONTROL	Position Reg	837	<b>755 Psn Load Actual</b> Position Load Actual Indicates accumulated output of the load gear ratio as a 32-bit integer and forms the primary feedback for the position regulator integral channel. It is very important that the load gear ratio be precisely set such that the delta pulse count of one motor revolution equals the delta pulse count of this parameter.	Default: 0 Min/Max: -2147483648 / 2147483647	RO	32-bit Integer
		838	<b>Psn Reg Ki</b> Position Regulator Ki Sets position regulator integral gain as measured from position error to velocity reference. The value has gain units of (P.U. velocity/second) / (P.U. position) and is unit compatible with the position regulator proportional gain P839 [Psn Reg Kp]. An integral gain of 25 means that a per unit position error of 0.1 seconds will effect a 2.5 P.U. speed change per second.	Default: 4.00 Min/Max: 0.00 / 25000.00	RW	Real
		839	<b>Psn Reg Kp</b> Position Regulator Kp Sets position regulator gain as measured from position error to speed reference. The gain number is identically equal to position regulator bandwidth in radians/second. For example: A gain of 10 means that a P.U. position error of 0.1 seconds will effect a 1.0 P.U. speed change (1 per unit position error is the distance traveled in 1 second at base motor speed). The typical value of this parameter is typically 1/3 of the speed bandwidth (radians/second) but may be set considerably higher with careful tuning of the speed regulator output lead/lag filter.	Units: R/S Default: 4.00 Min/Max: 0.00 / 2000.00	RW	Real
		840	<b>PReg Pos Int Lmt</b> Position Regulation Positive Integral Limit Sets positive limit of the position regulator integral output. A value of 100% is equal to parameter 28 [Motor NP RPM].	Units: % Default: 100.00 Min/Max: 0.00 / 800.00	RW	Real
		841	<b>PReg Neg Int Lmt</b> Position Regulation Negative Integral Limit Sets negative limit of the position regulator integral output. A value of 100% is equal to parameter 28 [Motor NP RPM].	Units: % Default: -100.00 Min/Max: -800.00 / 0.00	RW	Real
		842	<b>PsnReg IntgrlOut</b> Position Regulation Integral Output Indicates output of the position regulator integral channel after the limit function.	Units: Hz RPM Default: 0.00 Min/Max: -/+P27 [Motor NP Hertz] x 8 -/+P28 [Motor NP RPM] x 8	RO	Real
		843	<b>PsnReg Spd Out</b> Position Regulation Speed Output Indicates final output of the position regulator.	Units: Hz RPM Default: 0.00 Min/Max: -/+P27 [Motor NP Hertz] x 8 -/+P28 [Motor NP RPM] x 8	RO	Real
		844	<b>PReg Pos Spd Lmt</b> Position Regulation Positive Speed Limit Sets positive speed limit of total position regulator output. A value of 100% is equal to parameter 28 [Motor NP RPM].	Units: % Default: 10.00 Min/Max: 0.00 / 800.00	RW	Real
		845	<b>PReg Neg Spd Lmt</b> Position Regulation Negative Speed Limit Sets negative speed limit of total position regulator output. A value of 100% is equal to parameter 28 [Motor NP RPM].	Units: % Default: -10.00 Min/Max: -800.00 / 0.00	RW	Real

File	Group	No.	Display Name Full Name Description	Values	Read-Write	Data Type
POSITION CONTROL	Position Reg	846	<b>Psn Reg Droop</b> Position Regulation Droop Sets position droop which limits the low frequency gain of the position regulators integral channel to a value of (1/droop). This parameter provides a means to fine tune the stability for load mounted feedback devices where lost motion may cause a problem. Typically, the position droop will have a value that is less than (1/position gain), perhaps even zero for tightly coupled loads. The position droop has a gain value of (P.U. position) / (P.U. speed). Note: 1 P.U. position is the distance traveled in 1 second at base motor speed.	Units: Secs Default: 0.00 Min/Max: 0.00 / 25.00	RW	Real
		847	<b>Psn Fdbk</b> Position Feedback Indicates the accumulated pulse count of the position feedback selected by the position feedback select P135 [Psn Fdbk Sel].	Default: 0 Min/Max: -2147483648 / 2147483647	RO	32-bit Integer
		848	 <b>755 Psn Gear Ratio</b> Position Gear Ratio Sets the load side gear ratio for position control. Adjust this parameter's value when the load side encoder is selected for the position feedback by P135 [Mtr Psn Fdk Sel], and the load is coupled to the motor through a gear. Calculation: Gear Ratio = (Number of teeth on Gear or driven) / (Number of teeth on Pinion or driver) When a motor (driver) and a load (driven) are coupled with a 20:1 gear box (the gear ratio = 20), the value of this parameter will be 20. This value affects the following parameters as a speed feed forward gain. P843 [PsnReg Spd Out] P783 [PTP Speed FwdRef] P807 [PLL Speed Out] P1472 [PCAM Vel Out]	Default: 1.0000 Min/Max: 0.0001 / 9999.0000	RW	Real

## Drive (Port 0) Communication File

File	Group	No.	Display Name Full Name Description	Values	Read-Write	Data Type
COMMUNICATION	Comm Control	865	<b>DPI Pt1 Flt Actn</b>	Default: 0 = "Fault" Options: 0 = "Fault" 1 = "Stop" 2 = "Zero Data" 3 = "Hold Last" 4 = "Send Flt Cfg"	RW	32-bit Integer
		866	<b>DPI Pt2 Flt Actn</b>			
		867	<b>DPI Pt3 Flt Actn</b> DPI Port <i>n</i> Fault Action Sets the response to a HIM communication loss. Note: This feature will not work if the HIM is the only Stop source. "Fault" (0) – Major fault indicated. Coast to Stop. "Stop" (1) – Type 2 alarm indicated. Stop according to P370 [Stop Mode A]. "Zero Data" (2) – Type 2 alarm indicated. If running, drive continues to run, speed reference goes to zero. "Hold Last" (3) – Type 2 alarm indicated. If running, drive continues to run at the last value entered from the HIM. "Send Flt Cfg" (4) – Type 2 alarm indicated. If running, drive continues to run at [DPI Ptr Flt Ref].			
		868	<b>DPI Pt1 Flt Ref</b>	Default: 0.00	RO	Real
		869	<b>DPI Pt2 Flt Ref</b>	Min/Max: -/+220000000.00		
		870	<b>DPI Pt3 Flt Ref</b> DPI Port <i>n</i> Fault Reference Sets a constant value for the speed reference when [DPI Ptr Flt Actn] option 4 "Send Flt Cfg" is set and a HIM communication loss is detected.			

File	Group	No.	Display Name Full Name Description	Values	Read-Write	Data Type																																																																																																
COMMUNICATION	Comm Control	871	<b>Port 1 Reference</b>	Units: Hz RPM Default: 0.00 Min/Max: -/+P27 [Motor NP Hertz] x 8 -/+P28 [Motor NP RPM] x 8	RO	Real																																																																																																
		872	<b>Port 2 Reference</b>																																																																																																			
		873	<b>Port 3 Reference</b>																																																																																																			
		874	<b>Port 4 Reference</b>																																																																																																			
		875	<b>Port 5 Reference</b>																																																																																																			
		876	<b>Port 6 Reference</b>																																																																																																			
		877	<b>755 Port13 Reference</b>																																																																																																			
		878	<b>Port14 Reference</b> Port <i>n</i> Reference Reference value from port devices.																																																																																																			
		879	<b>Drive Logic Rslt</b> Drive Logic Result  This is the logic output of the logic parser that combines the outputs from the DPI ports and the DeviceLogix controller to determine drive control based on the masks and owners. Used for peer to peer communication with PowerFlex 750-Series communication modules.  Options	RO	32-bit Integer																																																																																																	
			<table border="1"> <thead> <tr> <th></th> <th>Reserved</th> <th>Reserved</th> <th>Reserved</th> <th>Reserved</th> <th>Reserved</th> <th>Reserved</th> <th>Reserved</th> <th>Reserved</th> <th>Reserved</th> <th>Reserved</th> <th>Reserved</th> <th>Reserved</th> <th>Reserved</th> <th>Jog 2</th> <th>Run</th> <th>Climit Stop</th> <th>Coast Stop</th> <th>Emrg OvrRide</th> <th>SpdRef Sel 2</th> <th>SpdRef Sel 1</th> <th>SpdRef Sel 0</th> <th>Decel Time 2</th> <th>Decel Time 1</th> <th>Accel Time 2</th> <th>Accel Time 1</th> <th>Reserved</th> <th>Manual</th> <th>Reverse</th> <th>Forward</th> <th>Clear Faults</th> <th>Jog 1</th> <th>Start</th> <th>Stop</th> </tr> </thead> <tbody> <tr> <td>Default</td> <td>0</td><td>0</td><td>0</td><td>0</td><td>0</td><td>0</td><td>0</td><td>0</td><td>0</td><td>0</td><td>0</td><td>0</td><td>0</td><td>0</td><td>0</td><td>0</td><td>0</td><td>0</td><td>0</td><td>0</td><td>0</td><td>0</td><td>0</td><td>0</td><td>0</td><td>0</td><td>0</td><td>0</td><td>0</td><td>0</td><td>0</td><td>0</td><td>0</td> </tr> <tr> <td>Bit</td> <td>31</td><td>30</td><td>29</td><td>28</td><td>27</td><td>26</td><td>25</td><td>24</td><td>23</td><td>22</td><td>21</td><td>20</td><td>19</td><td>18</td><td>17</td><td>16</td><td>15</td><td>14</td><td>13</td><td>12</td><td>11</td><td>10</td><td>9</td><td>8</td><td>7</td><td>6</td><td>5</td><td>4</td><td>3</td><td>2</td><td>1</td><td>0</td> </tr> </tbody> </table> <p style="text-align: right;">0 = False, 1 = True</p>		Reserved	Reserved	Reserved	Reserved	Reserved	Reserved	Reserved	Reserved	Reserved	Reserved	Reserved	Reserved	Reserved	Jog 2	Run	Climit Stop	Coast Stop	Emrg OvrRide	SpdRef Sel 2	SpdRef Sel 1	SpdRef Sel 0	Decel Time 2	Decel Time 1	Accel Time 2	Accel Time 1	Reserved	Manual	Reverse	Forward	Clear Faults	Jog 1	Start	Stop	Default	0	0	0	0	0	0	0	0	0	0	0	0	0	0	0	0	0	0	0	0	0	0	0	0	0	0	0	0	0	0	0	0	0	Bit	31	30	29	28	27	26	25	24	23	22	21	20	19	18	17	16	15	14	13	12	11	10	9	8	7	6	5	4	3	2
	Reserved	Reserved	Reserved	Reserved	Reserved	Reserved	Reserved	Reserved	Reserved	Reserved	Reserved	Reserved	Reserved	Jog 2	Run	Climit Stop	Coast Stop	Emrg OvrRide	SpdRef Sel 2	SpdRef Sel 1	SpdRef Sel 0	Decel Time 2	Decel Time 1	Accel Time 2	Accel Time 1	Reserved	Manual	Reverse	Forward	Clear Faults	Jog 1	Start	Stop																																																																					
Default	0	0	0	0	0	0	0	0	0	0	0	0	0	0	0	0	0	0	0	0	0	0	0	0	0	0	0	0	0	0	0	0	0																																																																					
Bit	31	30	29	28	27	26	25	24	23	22	21	20	19	18	17	16	15	14	13	12	11	10	9	8	7	6	5	4	3	2	1	0																																																																						
880	<b>DPI Ref Rslt</b> DPI Reference Result  Present speed reference scaled as a DPI reference for peer to peer communications. The value shown is the value prior to the accel/decel ramp and the corrections supplied by slip comp, PI, etc. Used for peer to peer communication with 20-COMM communication modules.	Units: Hz RPM Default: 0.000 Min/Max: -2147483.648 / 2147483.624	RO	32-bit Integer																																																																																																		
881	<b>DPI Ramp Rslt</b> DPI Ramp Result  Displays the speed reference value, after the limit function. This is the input to the error calculator and speed regulator. Used for peer-to-peer communication with 20-COMM communication modules.	Units: Hz RPM Default: 0.000 Min/Max: -2147483.648 / 2147483.624	RO	32-bit Integer																																																																																																		
882	<b>DPI Logic Rslt</b> DPI Logic Result  A version of P879 that is used when doing peer-to-peer control with a 20-COMM communication module. The lower 16 bit command values are copied into the upper 16 bits of this 32-bit parameter for use with this type of communication module. Not for use with a 20-750 communication module.  Options	RO	32-bit Integer																																																																																																			
	<table border="1"> <thead> <tr> <th></th> <th>Emrg OvrRide</th> <th>SpdRef Sel 2</th> <th>SpdRef Sel 1</th> <th>SpdRef Sel 0</th> <th>Decel Time 2</th> <th>Decel Time 1</th> <th>Accel Time 2</th> <th>Accel Time 1</th> <th>Reserved</th> <th>Manual</th> <th>Reverse</th> <th>Forward</th> <th>Clear Faults</th> <th>Jog 1</th> <th>Start</th> <th>Stop</th> <th>Emrg OvrRide</th> <th>SpdRef Sel 2</th> <th>SpdRef Sel 1</th> <th>SpdRef Sel 0</th> <th>Decel Time 2</th> <th>Decel Time 1</th> <th>Accel Time 2</th> <th>Accel Time 1</th> <th>Reserved</th> <th>Manual</th> <th>Reverse</th> <th>Forward</th> <th>Clear Faults</th> <th>Jog 1</th> <th>Start</th> <th>Stop</th> </tr> </thead> <tbody> <tr> <td>Default</td> <td>0</td><td>0</td><td>0</td><td>0</td><td>0</td><td>0</td><td>0</td><td>0</td><td>0</td><td>0</td><td>0</td><td>0</td><td>0</td><td>0</td><td>0</td><td>0</td><td>0</td><td>0</td><td>0</td><td>0</td><td>0</td><td>0</td><td>0</td><td>0</td><td>0</td><td>0</td><td>0</td><td>0</td><td>0</td><td>0</td><td>0</td><td>0</td> </tr> <tr> <td>Bit</td> <td>31</td><td>30</td><td>29</td><td>28</td><td>27</td><td>26</td><td>25</td><td>24</td><td>23</td><td>22</td><td>21</td><td>20</td><td>19</td><td>18</td><td>17</td><td>16</td><td>15</td><td>14</td><td>13</td><td>12</td><td>11</td><td>10</td><td>9</td><td>8</td><td>7</td><td>6</td><td>5</td><td>4</td><td>3</td><td>2</td><td>1</td><td>0</td> </tr> </tbody> </table> <p style="text-align: right;">0 = False, 1 = True</p>		Emrg OvrRide	SpdRef Sel 2	SpdRef Sel 1	SpdRef Sel 0	Decel Time 2	Decel Time 1	Accel Time 2	Accel Time 1	Reserved	Manual	Reverse	Forward	Clear Faults	Jog 1	Start	Stop	Emrg OvrRide	SpdRef Sel 2	SpdRef Sel 1	SpdRef Sel 0	Decel Time 2	Decel Time 1	Accel Time 2	Accel Time 1	Reserved	Manual	Reverse	Forward	Clear Faults	Jog 1	Start	Stop	Default	0	0	0	0	0	0	0	0	0	0	0	0	0	0	0	0	0	0	0	0	0	0	0	0	0	0	0	0	0	0	0	0	Bit	31	30	29	28	27	26	25	24	23	22	21	20	19	18	17	16	15	14	13	12	11	10	9	8	7	6	5	4	3	2	1	0		
	Emrg OvrRide	SpdRef Sel 2	SpdRef Sel 1	SpdRef Sel 0	Decel Time 2	Decel Time 1	Accel Time 2	Accel Time 1	Reserved	Manual	Reverse	Forward	Clear Faults	Jog 1	Start	Stop	Emrg OvrRide	SpdRef Sel 2	SpdRef Sel 1	SpdRef Sel 0	Decel Time 2	Decel Time 1	Accel Time 2	Accel Time 1	Reserved	Manual	Reverse	Forward	Clear Faults	Jog 1	Start	Stop																																																																						
Default	0	0	0	0	0	0	0	0	0	0	0	0	0	0	0	0	0	0	0	0	0	0	0	0	0	0	0	0	0	0	0	0																																																																						
Bit	31	30	29	28	27	26	25	24	23	22	21	20	19	18	17	16	15	14	13	12	11	10	9	8	7	6	5	4	3	2	1	0																																																																						
883	<b>Drive Ref Rslt</b> Drive Reference Result  Present frequency reference scaled as a DPI reference for peer to peer communications. The value shown is the value prior to the accel/decel ramp and the corrections supplied by slip comp, PI, etc. Used for peer to peer communication with 20-COMM communication modules.	Units: Hz RPM Default: 0.000 Min/Max: -/+2147483648.000	RO	Real																																																																																																		
884	<b>Drive Ramp Rslt</b> Drive Ramp Result  Displays the speed reference value, after the limit function. This is the input to the error calculator and speed regulator. This number is scaled so that rated motor speed will read 32768. Used for peer to peer communication with 20-COMM communication modules.	Units: Hz RPM Default: 0.000 Min/Max: -/+2147483648.000	RO	Real																																																																																																		

File	Group	No.	Display Name Full Name Description	Values	Read-Write	Data Type																																																				
COMMUNICATION	Security	885	<b>Port Mask Act</b> Port Mask Active  Active status for port communication. Bit 15 "Security" determines if network security is controlling the port mask instead of this parameter. For example, bit 15 can be active (control the port mask) when Automatic Device Configuration (ADC) is active.  Options	<table border="1"> <thead> <tr> <th></th> <th>Security</th> <th>Port 14</th> <th>Port 13</th> <th>Reserved</th> <th>Port 11</th> <th>Port 10</th> <th>Port 9</th> <th>Port 8</th> <th>Port 7</th> <th>Port 6</th> <th>Port 5</th> <th>Port 4</th> <th>Port 3</th> <th>Port 2</th> <th>Port 1</th> <th>Digital In</th> </tr> </thead> <tbody> <tr> <td>Default</td> <td>0</td> <td>0</td> <td>0</td> <td>0</td> <td>0</td> <td>0</td> <td>0</td> <td>0</td> <td>0</td> <td>0</td> <td>0</td> <td>0</td> <td>0</td> <td>0</td> <td>0</td> <td>0</td> </tr> <tr> <td>Bit</td> <td>15</td> <td>14</td> <td>13</td> <td>12</td> <td>11</td> <td>10</td> <td>9</td> <td>8</td> <td>7</td> <td>6</td> <td>5</td> <td>4</td> <td>3</td> <td>2</td> <td>1</td> <td>0</td> </tr> </tbody> </table>		Security	Port 14	Port 13	Reserved	Port 11	Port 10	Port 9	Port 8	Port 7	Port 6	Port 5	Port 4	Port 3	Port 2	Port 1	Digital In	Default	0	0	0	0	0	0	0	0	0	0	0	0	0	0	0	0	Bit	15	14	13	12	11	10	9	8	7	6	5	4	3	2	1	0	0 = Read Only 1 = Read/Write	RO	16-bit Integer
			Security	Port 14	Port 13	Reserved	Port 11	Port 10	Port 9	Port 8	Port 7	Port 6	Port 5	Port 4	Port 3	Port 2	Port 1	Digital In																																								
		Default	0	0	0	0	0	0	0	0	0	0	0	0	0	0	0	0																																								
		Bit	15	14	13	12	11	10	9	8	7	6	5	4	3	2	1	0																																								
886	<b>Logic Mask Act</b> Logic Mask Active  Active status of the logic mask for ports. Bit 15 "Security" determines if network security is controlling the logic mask instead of this parameter.  Options	<table border="1"> <thead> <tr> <th></th> <th>Security</th> <th>Port 14</th> <th>Port 13</th> <th>Reserved</th> <th>Reserved</th> <th>Reserved</th> <th>Reserved</th> <th>Reserved</th> <th>Reserved</th> <th>Port 6</th> <th>Port 5</th> <th>Port 4</th> <th>Port 3</th> <th>Port 2</th> <th>Port 1</th> <th>Digital In</th> </tr> </thead> <tbody> <tr> <td>Default</td> <td>0</td> <td>0</td> <td>0</td> <td>0</td> <td>0</td> <td>0</td> <td>0</td> <td>0</td> <td>0</td> <td>0</td> <td>0</td> <td>0</td> <td>0</td> <td>0</td> <td>0</td> <td>0</td> </tr> <tr> <td>Bit</td> <td>15</td> <td>14</td> <td>13</td> <td>12</td> <td>11</td> <td>10</td> <td>9</td> <td>8</td> <td>7</td> <td>6</td> <td>5</td> <td>4</td> <td>3</td> <td>2</td> <td>1</td> <td>0</td> </tr> </tbody> </table>		Security	Port 14	Port 13	Reserved	Reserved	Reserved	Reserved	Reserved	Reserved	Port 6	Port 5	Port 4	Port 3	Port 2	Port 1	Digital In	Default	0	0	0	0	0	0	0	0	0	0	0	0	0	0	0	0	Bit	15	14	13	12	11	10	9	8	7	6	5	4	3	2	1	0	0 = Read Only 1 = Read/Write	RO	16-bit Integer		
	Security	Port 14	Port 13	Reserved	Reserved	Reserved	Reserved	Reserved	Reserved	Port 6	Port 5	Port 4	Port 3	Port 2	Port 1	Digital In																																										
Default	0	0	0	0	0	0	0	0	0	0	0	0	0	0	0	0																																										
Bit	15	14	13	12	11	10	9	8	7	6	5	4	3	2	1	0																																										
887	<b>Write Mask Act</b> Write Mask Active  Active status of write access for ports. Bit 15 "Security" determines if network security is controlling the write mask instead of this parameter.  Options	<table border="1"> <thead> <tr> <th></th> <th>Security</th> <th>Port 14</th> <th>Port 13</th> <th>Reserved</th> <th>Port 11</th> <th>Port 10</th> <th>Port 9</th> <th>Port 8</th> <th>Port 7</th> <th>Port 6</th> <th>Port 5</th> <th>Port 4</th> <th>Port 3</th> <th>Port 2</th> <th>Port 1</th> <th>Reserved</th> </tr> </thead> <tbody> <tr> <td>Default</td> <td>0</td> <td>0</td> <td>0</td> <td>0</td> <td>0</td> <td>0</td> <td>0</td> <td>0</td> <td>0</td> <td>1</td> <td>1</td> <td>1</td> <td>1</td> <td>1</td> <td>1</td> <td>0</td> </tr> <tr> <td>Bit</td> <td>15</td> <td>14</td> <td>13</td> <td>12</td> <td>11</td> <td>10</td> <td>9</td> <td>8</td> <td>7</td> <td>6</td> <td>5</td> <td>4</td> <td>3</td> <td>2</td> <td>1</td> <td>0</td> </tr> </tbody> </table>		Security	Port 14	Port 13	Reserved	Port 11	Port 10	Port 9	Port 8	Port 7	Port 6	Port 5	Port 4	Port 3	Port 2	Port 1	Reserved	Default	0	0	0	0	0	0	0	0	0	1	1	1	1	1	1	0	Bit	15	14	13	12	11	10	9	8	7	6	5	4	3	2	1	0	0 = Read Only 1 = Read/Write	RO	16-bit Integer		
	Security	Port 14	Port 13	Reserved	Port 11	Port 10	Port 9	Port 8	Port 7	Port 6	Port 5	Port 4	Port 3	Port 2	Port 1	Reserved																																										
Default	0	0	0	0	0	0	0	0	0	1	1	1	1	1	1	0																																										
Bit	15	14	13	12	11	10	9	8	7	6	5	4	3	2	1	0																																										
888	<b>Write Mask Cfg</b> Write Mask Configuration  Enables/disables write access (parameters, links, etc.) for DPI ports. Changes to this parameter only become effective when power is cycled, the drive is reset or bit 15 of P887 [Write Mask Act], transitions from "1" to "0."  Options	<table border="1"> <thead> <tr> <th></th> <th>Reserved</th> <th>Port 14</th> <th>Port 13</th> <th>Reserved</th> <th>Port 11</th> <th>Port 10</th> <th>Port 9</th> <th>Port 8</th> <th>Port 7</th> <th>Port 6</th> <th>Port 5</th> <th>Port 4</th> <th>Port 3</th> <th>Port 2</th> <th>Port 1</th> <th>Reserved</th> </tr> </thead> <tbody> <tr> <td>Default</td> <td>0</td> <td>1</td> <td>1</td> <td>0</td> <td>1</td> <td>1</td> <td>1</td> <td>1</td> <td>1</td> <td>1</td> <td>1</td> <td>1</td> <td>1</td> <td>1</td> <td>1</td> <td>0</td> </tr> <tr> <td>Bit</td> <td>15</td> <td>14</td> <td>13</td> <td>12</td> <td>11</td> <td>10</td> <td>9</td> <td>8</td> <td>7</td> <td>6</td> <td>5</td> <td>4</td> <td>3</td> <td>2</td> <td>1</td> <td>0</td> </tr> </tbody> </table>		Reserved	Port 14	Port 13	Reserved	Port 11	Port 10	Port 9	Port 8	Port 7	Port 6	Port 5	Port 4	Port 3	Port 2	Port 1	Reserved	Default	0	1	1	0	1	1	1	1	1	1	1	1	1	1	1	0	Bit	15	14	13	12	11	10	9	8	7	6	5	4	3	2	1	0	0 = Read Only 1 = Read/Write	RW	16-bit Integer		
	Reserved	Port 14	Port 13	Reserved	Port 11	Port 10	Port 9	Port 8	Port 7	Port 6	Port 5	Port 4	Port 3	Port 2	Port 1	Reserved																																										
Default	0	1	1	0	1	1	1	1	1	1	1	1	1	1	1	0																																										
Bit	15	14	13	12	11	10	9	8	7	6	5	4	3	2	1	0																																										

File	Group	No.	Display Name Full Name Description	Values	Read-Write	Data Type	
COMMUNICATION	DPI Datalinks		<b>Important:</b> DPI Datalinks parameters are used for datalinks on legacy 20-COMM- <i>n</i> communication devices. For embedded EtherNet/IP or 20-750 option datalinks, refer to the parameters associated with the specific option module.				
		895	<b>Data In A1</b>		Default: 0 (0 = "Disabled")	RW	32-bit Integer
		896	<b>Data In A2</b> Data Input <i>A<sub>n</sub></i> Parameter number whose value will be written from a communications device data table.	Min/Max: 0 / 159999			
		897	<b>Data In B1</b>		See [Data In A1].		
		898	<b>Data In B2</b> Data Input <i>B<sub>n</sub></i> Parameter number whose value will be written from a communications device data table.				
		899	<b>Data In C1</b>		See [Data In A1].		
		900	<b>Data In C2</b> Data Input <i>C<sub>n</sub></i> Parameter number whose value will be written from a communications device data table.				
		901	<b>Data In D1</b>		See [Data In A1].		
		902	<b>Data In D2</b> Data Input <i>D<sub>n</sub></i> Parameter number whose value will be written from a communications device data table.				
		905	<b>Data Out A1</b>		Default: 0 (0 = "Disabled")	RW	32-bit Integer
		906	<b>Data Out A2</b> Data Output <i>A<sub>n</sub></i> Parameter number whose value will be written to a communications device data table.	Min/Max: 0 / 159999			
		907	<b>Data Out B1</b>		See [Data Out A1].		
		908	<b>Data Out B2</b> Data Output <i>B<sub>n</sub></i> Parameter number whose value will be written from a communications device data table.				
		909	<b>Data Out C1</b>		See [Data Out A1].		
910	<b>Data Out C2</b> Data Output <i>C<sub>n</sub></i> Parameter number whose value will be written from a communications device data table.						
911	<b>Data Out D1</b>		See [Data Out A1].				
912	<b>Data Out D2</b> Data Output <i>D<sub>n</sub></i> Parameter number whose value will be written from a communications device data table.						

File	Group	No.	Display Name Full Name Description	Values	Read-Write	Data Type																																																						
COMMUNICATION	Owners	919	<b>Stop Owner</b> Stop Owner Indicates which port is currently issuing a valid stop command.  Options <table border="1"> <tr> <td></td> <td>Reserved</td> <td>Port 14</td> <td>Port 13 (1)</td> <td>Reserved</td> <td>Reserved</td> <td>Reserved</td> <td>Reserved</td> <td>Reserved</td> <td>Reserved</td> <td>Reserved</td> <td>Port 6</td> <td>Port 5</td> <td>Port 4</td> <td>Port 3</td> <td>Port 2</td> <td>Port 1</td> <td>Digital In(2)</td> </tr> <tr> <td>Default</td> <td>0</td> <td>0</td> <td>0</td> <td>0</td> <td>0</td> <td>0</td> <td>0</td> <td>0</td> <td>0</td> <td>0</td> <td>0</td> <td>0</td> <td>0</td> <td>0</td> <td>0</td> <td>0</td> <td>0</td> </tr> <tr> <td>Bit</td> <td>15</td> <td>14</td> <td>13</td> <td>12</td> <td>11</td> <td>10</td> <td>9</td> <td>8</td> <td>7</td> <td>6</td> <td>5</td> <td>4</td> <td>3</td> <td>2</td> <td>1</td> <td>0</td> <td></td> </tr> </table> 0 = False 1 = True  (1) 755 drives only. (2) If parameter 150 [Digital In Cfg] =1 "Run Level" the absence of a run command is indicated as a stop asserted.		Reserved	Port 14	Port 13 (1)	Reserved	Reserved	Reserved	Reserved	Reserved	Reserved	Reserved	Port 6	Port 5	Port 4	Port 3	Port 2	Port 1	Digital In(2)	Default	0	0	0	0	0	0	0	0	0	0	0	0	0	0	0	0	0	Bit	15	14	13	12	11	10	9	8	7	6	5	4	3	2	1	0			RO	16-bit Integer
			Reserved	Port 14	Port 13 (1)	Reserved	Reserved	Reserved	Reserved	Reserved	Reserved	Reserved	Port 6	Port 5	Port 4	Port 3	Port 2	Port 1	Digital In(2)																																									
		Default	0	0	0	0	0	0	0	0	0	0	0	0	0	0	0	0	0																																									
		Bit	15	14	13	12	11	10	9	8	7	6	5	4	3	2	1	0																																										
920	<b>Start Owner</b> Start Owner Indicates which port is currently issuing a valid start command.  Options <table border="1"> <tr> <td></td> <td>Reserved</td> <td>Port 14</td> <td>Port 13 (1)</td> <td>Reserved</td> <td>Reserved</td> <td>Reserved</td> <td>Reserved</td> <td>Reserved</td> <td>Reserved</td> <td>Reserved</td> <td>Port 6</td> <td>Port 5</td> <td>Port 4</td> <td>Port 3</td> <td>Port 2</td> <td>Port 1</td> <td>Digital In</td> </tr> <tr> <td>Default</td> <td>0</td> <td>0</td> <td>0</td> <td>0</td> <td>0</td> <td>0</td> <td>0</td> <td>0</td> <td>0</td> <td>0</td> <td>0</td> <td>0</td> <td>0</td> <td>0</td> <td>0</td> <td>0</td> <td>0</td> </tr> <tr> <td>Bit</td> <td>15</td> <td>14</td> <td>13</td> <td>12</td> <td>11</td> <td>10</td> <td>9</td> <td>8</td> <td>7</td> <td>6</td> <td>5</td> <td>4</td> <td>3</td> <td>2</td> <td>1</td> <td>0</td> <td></td> </tr> </table> 0 = False 1 = True  (1) 755 drives only.		Reserved	Port 14	Port 13 (1)	Reserved	Reserved	Reserved	Reserved	Reserved	Reserved	Reserved	Port 6	Port 5	Port 4	Port 3	Port 2	Port 1	Digital In	Default	0	0	0	0	0	0	0	0	0	0	0	0	0	0	0	0	0	Bit	15	14	13	12	11	10	9	8	7	6	5	4	3	2	1	0			RO	16-bit Integer		
	Reserved	Port 14	Port 13 (1)	Reserved	Reserved	Reserved	Reserved	Reserved	Reserved	Reserved	Port 6	Port 5	Port 4	Port 3	Port 2	Port 1	Digital In																																											
Default	0	0	0	0	0	0	0	0	0	0	0	0	0	0	0	0	0																																											
Bit	15	14	13	12	11	10	9	8	7	6	5	4	3	2	1	0																																												
921	<b>Jog Owner</b> Jog Owner Indicates which port is currently issuing a valid jog command.  Options <table border="1"> <tr> <td></td> <td>Reserved</td> <td>Port 14</td> <td>Port 13 (1)</td> <td>Reserved</td> <td>Reserved</td> <td>Reserved</td> <td>Reserved</td> <td>Reserved</td> <td>Reserved</td> <td>Reserved</td> <td>Port 6</td> <td>Port 5</td> <td>Port 4</td> <td>Port 3</td> <td>Port 2</td> <td>Port 1</td> <td>Digital In</td> </tr> <tr> <td>Default</td> <td>0</td> <td>0</td> <td>0</td> <td>0</td> <td>0</td> <td>0</td> <td>0</td> <td>0</td> <td>0</td> <td>0</td> <td>0</td> <td>0</td> <td>0</td> <td>0</td> <td>0</td> <td>0</td> <td>0</td> </tr> <tr> <td>Bit</td> <td>15</td> <td>14</td> <td>13</td> <td>12</td> <td>11</td> <td>10</td> <td>9</td> <td>8</td> <td>7</td> <td>6</td> <td>5</td> <td>4</td> <td>3</td> <td>2</td> <td>1</td> <td>0</td> <td></td> </tr> </table> 0 = False 1 = True  (1) 755 drives only.		Reserved	Port 14	Port 13 (1)	Reserved	Reserved	Reserved	Reserved	Reserved	Reserved	Reserved	Port 6	Port 5	Port 4	Port 3	Port 2	Port 1	Digital In	Default	0	0	0	0	0	0	0	0	0	0	0	0	0	0	0	0	0	Bit	15	14	13	12	11	10	9	8	7	6	5	4	3	2	1	0			RO	16-bit Integer		
	Reserved	Port 14	Port 13 (1)	Reserved	Reserved	Reserved	Reserved	Reserved	Reserved	Reserved	Port 6	Port 5	Port 4	Port 3	Port 2	Port 1	Digital In																																											
Default	0	0	0	0	0	0	0	0	0	0	0	0	0	0	0	0	0																																											
Bit	15	14	13	12	11	10	9	8	7	6	5	4	3	2	1	0																																												
922	<b>Dir Owner</b> Direction Owner Indicates which port has exclusive control of direction changes. Only one port can own the direction function at one time.  Options <table border="1"> <tr> <td></td> <td>Reserved</td> <td>Port 14</td> <td>Port 13 (1)</td> <td>Reserved</td> <td>Reserved</td> <td>Reserved</td> <td>Reserved</td> <td>Reserved</td> <td>Reserved</td> <td>Reserved</td> <td>Port 6</td> <td>Port 5</td> <td>Port 4</td> <td>Port 3</td> <td>Port 2</td> <td>Port 1</td> <td>Digital In</td> </tr> <tr> <td>Default</td> <td>0</td> <td>0</td> <td>0</td> <td>0</td> <td>0</td> <td>0</td> <td>0</td> <td>0</td> <td>0</td> <td>0</td> <td>0</td> <td>0</td> <td>0</td> <td>0</td> <td>0</td> <td>0</td> <td>0</td> </tr> <tr> <td>Bit</td> <td>15</td> <td>14</td> <td>13</td> <td>12</td> <td>11</td> <td>10</td> <td>9</td> <td>8</td> <td>7</td> <td>6</td> <td>5</td> <td>4</td> <td>3</td> <td>2</td> <td>1</td> <td>0</td> <td></td> </tr> </table> 0 = False 1 = True  (1) 755 drives only.		Reserved	Port 14	Port 13 (1)	Reserved	Reserved	Reserved	Reserved	Reserved	Reserved	Reserved	Port 6	Port 5	Port 4	Port 3	Port 2	Port 1	Digital In	Default	0	0	0	0	0	0	0	0	0	0	0	0	0	0	0	0	0	Bit	15	14	13	12	11	10	9	8	7	6	5	4	3	2	1	0			RO	16-bit Integer		
	Reserved	Port 14	Port 13 (1)	Reserved	Reserved	Reserved	Reserved	Reserved	Reserved	Reserved	Port 6	Port 5	Port 4	Port 3	Port 2	Port 1	Digital In																																											
Default	0	0	0	0	0	0	0	0	0	0	0	0	0	0	0	0	0																																											
Bit	15	14	13	12	11	10	9	8	7	6	5	4	3	2	1	0																																												

File	Group	No.	Display Name Full Name Description	Values	Read-Write	Data Type																																																			
COMMUNICATION	Owners	923	<b>Clear Flt Owner</b> Clear Fault Owner Indicates which port is currently clearing a fault.  Options <table border="1"> <thead> <tr> <th></th> <th>Reserved</th> <th>Port 14</th> <th>Port 13 (1)</th> <th>Reserved</th> <th>Reserved</th> <th>Reserved</th> <th>Reserved</th> <th>Reserved</th> <th>Reserved</th> <th>Port 6</th> <th>Port 5</th> <th>Port 4</th> <th>Port 3</th> <th>Port 2</th> <th>Port 1</th> <th>Digital In</th> </tr> </thead> <tbody> <tr> <td>Default</td> <td>0</td> <td>0</td> <td>0</td> <td>0</td> <td>0</td> <td>0</td> <td>0</td> <td>0</td> <td>0</td> <td>0</td> <td>0</td> <td>0</td> <td>0</td> <td>0</td> <td>0</td> <td>0</td> </tr> <tr> <td>Bit</td> <td>15</td> <td>14</td> <td>13</td> <td>12</td> <td>11</td> <td>10</td> <td>9</td> <td>8</td> <td>7</td> <td>6</td> <td>5</td> <td>4</td> <td>3</td> <td>2</td> <td>1</td> <td>0</td> </tr> </tbody> </table> 0 = False 1 = True  (1) 755 drives only.		Reserved	Port 14	Port 13 (1)	Reserved	Reserved	Reserved	Reserved	Reserved	Reserved	Port 6	Port 5	Port 4	Port 3	Port 2	Port 1	Digital In	Default	0	0	0	0	0	0	0	0	0	0	0	0	0	0	0	0	Bit	15	14	13	12	11	10	9	8	7	6	5	4	3	2	1	0		RO	16-bit Integer
			Reserved	Port 14	Port 13 (1)	Reserved	Reserved	Reserved	Reserved	Reserved	Reserved	Port 6	Port 5	Port 4	Port 3	Port 2	Port 1	Digital In																																							
		Default	0	0	0	0	0	0	0	0	0	0	0	0	0	0	0	0																																							
Bit	15	14	13	12	11	10	9	8	7	6	5	4	3	2	1	0																																									
924	<b>Manual Owner</b> Manual Owner Adapter that has requested manual control of all drive logic and/or reference functions. If an adapter is in manual lockout, all other functions (except stop) on all other adapters are locked out and non-functional. Monitor manual lockout status the associated owner status parameters.  Options <table border="1"> <thead> <tr> <th></th> <th>Reserved</th> <th>Port 14</th> <th>Port 13 (1)</th> <th>Reserved</th> <th>Reserved</th> <th>Reserved</th> <th>Reserved</th> <th>Reserved</th> <th>Reserved</th> <th>Port 6</th> <th>Port 5</th> <th>Port 4</th> <th>Port 3</th> <th>Port 2</th> <th>Port 1</th> <th>Digital In</th> </tr> </thead> <tbody> <tr> <td>Default</td> <td>0</td> <td>0</td> <td>0</td> <td>0</td> <td>0</td> <td>0</td> <td>0</td> <td>0</td> <td>0</td> <td>0</td> <td>0</td> <td>0</td> <td>0</td> <td>0</td> <td>0</td> <td>0</td> </tr> <tr> <td>Bit</td> <td>15</td> <td>14</td> <td>13</td> <td>12</td> <td>11</td> <td>10</td> <td>9</td> <td>8</td> <td>7</td> <td>6</td> <td>5</td> <td>4</td> <td>3</td> <td>2</td> <td>1</td> <td>0</td> </tr> </tbody> </table> 0 = False 1 = True  (1) 755 drives only.		Reserved	Port 14	Port 13 (1)	Reserved	Reserved	Reserved	Reserved	Reserved	Reserved	Port 6	Port 5	Port 4	Port 3	Port 2	Port 1	Digital In	Default	0	0	0	0	0	0	0	0	0	0	0	0	0	0	0	0	Bit	15	14	13	12	11	10	9	8	7	6	5	4	3	2	1	0		RO	16-bit Integer		
	Reserved	Port 14	Port 13 (1)	Reserved	Reserved	Reserved	Reserved	Reserved	Reserved	Port 6	Port 5	Port 4	Port 3	Port 2	Port 1	Digital In																																									
Default	0	0	0	0	0	0	0	0	0	0	0	0	0	0	0	0																																									
Bit	15	14	13	12	11	10	9	8	7	6	5	4	3	2	1	0																																									
925	<b>Ref Select Owner</b> Reference Select Owner Indicates which port is issuing a valid reference select.  Options <table border="1"> <thead> <tr> <th></th> <th>Reserved</th> <th>Port 14</th> <th>Port 13 (1)</th> <th>Reserved</th> <th>Reserved</th> <th>Reserved</th> <th>Reserved</th> <th>Reserved</th> <th>Reserved</th> <th>Port 6</th> <th>Port 5</th> <th>Port 4</th> <th>Port 3</th> <th>Port 2</th> <th>Port 1</th> <th>Digital In</th> </tr> </thead> <tbody> <tr> <td>Default</td> <td>0</td> <td>0</td> <td>0</td> <td>0</td> <td>0</td> <td>0</td> <td>0</td> <td>0</td> <td>0</td> <td>0</td> <td>0</td> <td>0</td> <td>0</td> <td>0</td> <td>0</td> <td>0</td> </tr> <tr> <td>Bit</td> <td>15</td> <td>14</td> <td>13</td> <td>12</td> <td>11</td> <td>10</td> <td>9</td> <td>8</td> <td>7</td> <td>6</td> <td>5</td> <td>4</td> <td>3</td> <td>2</td> <td>1</td> <td>0</td> </tr> </tbody> </table> 0 = False 1 = True  (1) 755 drives only.		Reserved	Port 14	Port 13 (1)	Reserved	Reserved	Reserved	Reserved	Reserved	Reserved	Port 6	Port 5	Port 4	Port 3	Port 2	Port 1	Digital In	Default	0	0	0	0	0	0	0	0	0	0	0	0	0	0	0	0	Bit	15	14	13	12	11	10	9	8	7	6	5	4	3	2	1	0		RO	16-bit Integer		
	Reserved	Port 14	Port 13 (1)	Reserved	Reserved	Reserved	Reserved	Reserved	Reserved	Port 6	Port 5	Port 4	Port 3	Port 2	Port 1	Digital In																																									
Default	0	0	0	0	0	0	0	0	0	0	0	0	0	0	0	0																																									
Bit	15	14	13	12	11	10	9	8	7	6	5	4	3	2	1	0																																									

File	Group	No.	Display Name Full Name Description	Values	Read-Write	Data Type
COMMUNICATION	ODK Datalinks	1700...1731	<b>UserData Int 00...31</b> User Data Integer 00...31 Available for storage of a 32-bit integer value by the user.	Default: 0 Min/Max: -2147483647 / 2147483647	RW	32-bit Integer
		1800...1831	<b>UserData Real 00...31</b> User Data Real 00...31 Available for storage of a real value by the user.	Default: 0.0000 Min/Max: -2147483647 / 2147483647	RW	Float
		1900 1904 1908 1912 1916 1920 1924 1928	<b>ScaleBlk Sel 00</b> <b>ScaleBlk Sel 01</b> <b>ScaleBlk Sel 02</b> <b>ScaleBlk Sel 03</b> <b>ScaleBlk Sel 04</b> <b>ScaleBlk Sel 05</b> <b>ScaleBlk Sel 06</b> <b>ScaleBlk Sel 07</b> Scale Block Select <i>n</i> Selects the source value to be scaled.	Default: Disabled Min/Max: 0 / 159999	RW	32-bit Integer
		1901 1905 1909 1913 1917 1921 1925 1929	<b>ScaleBlk Scal 00</b> <b>ScaleBlk Scal 01</b> <b>ScaleBlk Scal 02</b> <b>ScaleBlk Scal 03</b> <b>ScaleBlk Scal 04</b> <b>ScaleBlk Scal 05</b> <b>ScaleBlk Scal 06</b> <b>ScaleBlk Scal 07</b> Scale Block Scale <i>n</i> Scales (multiplier) the selected parameter value.	Default: 1.0000 Min/Max: -2147483647 / 2147483647	RW	Float
		1902 1906 1910 1914 1918 1922 1926 1930	<b>ScaleBlk Int 00</b> <b>ScaleBlk Int 01</b> <b>ScaleBlk Int 02</b> <b>ScaleBlk Int 03</b> <b>ScaleBlk Int 04</b> <b>ScaleBlk Int 05</b> <b>ScaleBlk Int 06</b> <b>ScaleBlk Int 07</b> Scale Block Integer <i>n</i> Displays the scaling result as a 32-bit integer value.	Default: 0 Min/Max: -2147483647 / 2147483647	RO	32-bit Integer
		1903 1907 1911 1915 1919 1923 1927 1931	<b>ScaleBlk Real 00</b> <b>ScaleBlk Real 01</b> <b>ScaleBlk Real 02</b> <b>ScaleBlk Real 03</b> <b>ScaleBlk Real 04</b> <b>ScaleBlk Real 05</b> <b>ScaleBlk Real 06</b> <b>ScaleBlk Real 07</b> Scale Block Real <i>n</i> Displays the scaling result as a real value.	Default: 0.0000 Min/Max: -2147483647 / 2147483647	RO	Float



## Drive (Port 0) Diagnostics File

File	Group	No.	Display Name Full Name Description	Values		Read-Write	Data Type
DIAGNOSTICS	Status	930	<b>Speed Ref Source</b> Speed Reference Source Indicates the currently selected source for value displayed in P593 [Limited Spd Ref]. The Speed Reference Source displays the parameter number that is supplying the speed reference. For example, if Speed Reference Source contains the value 546, then P546 [Spd Ref A Stpt] is the source of the speed reference.	Default: 0 Min/Max: 0 / 159999		RO	32-bit Integer
		931	<b>Last StartSource</b> Last Start Source Displays the source that initiated the most recent start sequence. All bits in this parameter are refreshed each time the drive receives a start command.	Default: 0 = Read Only Options: 0 = "Pwr Removed" 1-6 = "Port 1-6" 7 = "Digital In" 8 = "Sleep" 9 = "Jog" 10 = "Profiling" 11 = "AutoRestart" 12 = "Pwr Up Start" 13 = "Fault" 14 = "Enable" 15 = "Autotune" 16 = "Precharge" 17 = "Safety" 18 = "Fast Stop" 19 = "Port 13" 20 = "Port 14"		RO	32-bit Integer
		932	<b>Last Stop Source</b> Last Stop Source Displays the source that initiated the most recent stop sequence. All bits in this parameter are refreshed each time the drive receives a stop command.	Default: 0 = Read Only Options: 0 = "Pwr Removed" 1-6 = "Port 1-6" 7 = "Digital In" 8 = "Sleep" 9 = "Jog" 10 = "Profiling" 11 = "AutoRestart" 12 = "Pwr Up Start" 13 = "Fault" 14 = "Enable" 15 = "Autotune" 16 = "Precharge" 17 = "Safety" 18 = "Fast Stop" 19 = "Port 13" 20 = "Port 14"		RO	32-bit Integer



File	Group	No.	Display Name Full Name Description	Values	Read-Write	Data Type																																																																																																	
DIAGNOSTICS	Status	935	<b>Drive Status 1</b> Drive Status 1 Present operating condition of the drive.  Options		RO	32-bit Integer																																																																																																	
			<table border="1"> <thead> <tr> <th></th> <th>Regen</th> <th>Motor OL</th> <th>Enable On</th> <th>Bus Freq Reg</th> <th>Cur Limit</th> <th>At Limit</th> <th>At Home</th> <th>AtZero Speed</th> <th>Torque Mode</th> <th>Position Mode</th> <th>Speed Mode</th> <th>DB Active</th> <th>DC Braking</th> <th>Stopping</th> <th>Jogging</th> <th>Running</th> <th>Emrg OvrRide</th> <th>SpdRef Bit 4</th> <th>SpdRef Bit 3</th> <th>SpdRef Bit 2</th> <th>SpdRef Bit 1</th> <th>SpdRef Bit 0</th> <th>Manual</th> <th>At Speed</th> <th>Faulted</th> <th>Alarm</th> <th>Decelerating</th> <th>Accelerating</th> <th>Actual Dir</th> <th>Command Dir</th> <th>Active</th> <th>Ready</th> </tr> </thead> <tbody> <tr> <td>Default</td> <td>0</td> <td>0</td> <td>0</td> <td>0</td> <td>0</td> <td>0</td> <td>0</td> <td>0</td> <td>0</td> <td>0</td> <td>0</td> <td>0</td> <td>0</td> <td>0</td> <td>0</td> <td>0</td> <td>0</td> <td>0</td> <td>0</td> <td>0</td> <td>0</td> <td>0</td> <td>0</td> <td>0</td> <td>0</td> <td>0</td> <td>0</td> <td>0</td> <td>0</td> <td>0</td> <td>0</td> <td>0</td> </tr> <tr> <td>Bit</td> <td>31</td> <td>30</td> <td>29</td> <td>28</td> <td>27</td> <td>26</td> <td>25</td> <td>24</td> <td>23</td> <td>22</td> <td>21</td> <td>20</td> <td>19</td> <td>18</td> <td>17</td> <td>16</td> <td>15</td> <td>14</td> <td>13</td> <td>12</td> <td>11</td> <td>10</td> <td>9</td> <td>8</td> <td>7</td> <td>6</td> <td>5</td> <td>4</td> <td>3</td> <td>2</td> <td>1</td> <td>0</td> </tr> </tbody> </table> <p style="text-align: right;">0 = Condition False 1 = Condition True</p> <p>Bit 0 "Ready" – Condition is true if there are no start inhibits indicated by P933 [Start Inhibits]. When parameter 150 [Digital In Cfg] option 1 "Run Level" is selected and the run command is low, this bit will also be low.</p> <p>Bit 1 "Active" – Condition is true if drive is modulating.</p> <p>Bit 2 "Command Dir" – 1 = Commanded direction is forward. 0 = Commanded direction is reverse.</p> <p>Bit 3 "Actual Dir" – 1 = Actual direction is forward. 0 = Actual direction is reverse.</p> <p>Bit 4 "Accelerating" – For flux vector and non-vector control modes, this bit indicates when the actual motor speed is increasing due to change in speed reference. When accelerating, the motor speed is moving away from zero in either the positive (forward) or negative (reverse) direction. In adjustable voltage control mode, accelerating relates to an increasing output voltage and frequency. The "accelerating" bit will become clear when any of the following conditions occur:</p> <ul style="list-style-type: none"> <li>• drive inactive (Bit 1 "Active" status clear)</li> <li>• when "At Speed" (Bit 8 status set)</li> <li>• when "AtZero Speed" (Bit 24 set)</li> <li>• when "DC Braking" (Bit 19 set)</li> <li>• when the drive is operating as a torque regulator (Bit 23 without Bits 21 and 22)</li> <li>• when the drive is operating in position mode (Bit 22)</li> </ul> <p>Bit 5 "Decelerating" – This bit compliments the Accelerating status Bit 4 for the condition where the motor speed is decreasing due to a change in speed reference. When decelerating, the motor speed is moving toward zero in either the positive (forward) or negative (reverse) direction. In adjustable voltage control mode, decelerating relates to a decreasing output voltage and frequency. The conditions that will clear this bit are the same as those that apply to the Accelerating status bit.</p> <p>Bit 8 "At Speed" – This bit will become set when the actual motor speed has reached the speed reference value. This condition is determined by comparing P131 [Active Vel Fdbk] against P597 [Final Speed Ref]. "At Speed" occurs when the difference between speed reference and feedback is within 1 percent of motor nameplate speed. In adjustable voltage control mode, the "At Speed" condition will indicate when the output voltage and frequency have completed their ramps and are no longer changing. The "At Speed" bit will become clear when any of the following conditions occur: drive inactive (Bit 1 "Active" status clear) or when accelerating (Bit 4 set) or when decelerating (Bit 5 set).</p>		Regen	Motor OL	Enable On	Bus Freq Reg	Cur Limit	At Limit	At Home	AtZero Speed	Torque Mode	Position Mode	Speed Mode	DB Active	DC Braking	Stopping	Jogging	Running	Emrg OvrRide	SpdRef Bit 4	SpdRef Bit 3	SpdRef Bit 2	SpdRef Bit 1	SpdRef Bit 0	Manual	At Speed	Faulted	Alarm	Decelerating	Accelerating	Actual Dir	Command Dir	Active	Ready	Default	0	0	0	0	0	0	0	0	0	0	0	0	0	0	0	0	0	0	0	0	0	0	0	0	0	0	0	0	0	0	0	0	Bit	31	30	29	28	27	26	25	24	23	22	21	20	19	18	17	16	15	14	13	12	11	10	9	8	7	6	5	4	3	2	1	0	
	Regen	Motor OL	Enable On	Bus Freq Reg	Cur Limit	At Limit	At Home	AtZero Speed	Torque Mode	Position Mode	Speed Mode	DB Active	DC Braking	Stopping	Jogging	Running	Emrg OvrRide	SpdRef Bit 4	SpdRef Bit 3	SpdRef Bit 2	SpdRef Bit 1	SpdRef Bit 0	Manual	At Speed	Faulted	Alarm	Decelerating	Accelerating	Actual Dir	Command Dir	Active	Ready																																																																							
Default	0	0	0	0	0	0	0	0	0	0	0	0	0	0	0	0	0	0	0	0	0	0	0	0	0	0	0	0	0	0	0	0																																																																							
Bit	31	30	29	28	27	26	25	24	23	22	21	20	19	18	17	16	15	14	13	12	11	10	9	8	7	6	5	4	3	2	1	0																																																																							

File	Group	No.	Display Name Full Name Description	Values	Read-Write	Data Type			
DIAGNOSTICS	Status	<b>Drive Status 1 Bit Descriptions</b> Bits 10... 14 "SpdRef Bit x" – See Table 935A: Reference Status:							
		<b>Table 935A: Reference Status</b>							
		Bit	14	13	12	11	10	Reference Source	Parameter
			0	0	0	0	1	Auto, Ref A	545
			0	0	0	1	0	Auto, Ref B	550
			0	0	0	1	1	Auto, Preset 3	573
			0	0	1	0	0	Auto, Preset 4	574
			0	0	1	0	1	Auto, Preset 5	575
			0	0	1	1	0	Auto, Preset 6	576
			0	0	1	1	1	Auto, Preset 7	577
			1	0	0	0	0	MAN, Port 0, DIGIN SEL	563
			1	0	0	0	1	MAN, Port 1	871
			1	0	0	1	0	MAN, Port 2	872
			1	0	0	1	1	MAN, Port 3	873
			1	0	1	0	0	MAN, Port 4	874
			1	0	1	0	1	MAN, Port 5	875
			1	0	1	1	0	MAN, Port 6	876
			1	1	1	0	1	MAN, Port 13 INT. ENET	877
	1	1	1	1	0	MAN, Port 14 DRV LOGIX	878		
	1	1	1	1	1	ALT MAN REF SEL	328		

File	Group	No.	Display Name Full Name Description	Values	Read-Write	Data Type
DIAGNOSTICS	Status		<p>Bit 15 "Emrg OvrRide" – This bit is set when the drive is in Emergency Override.</p> <p>Bit 16 "Running" – This bit indicates that the drive has successfully responded to a start signal. The "Active" (Bit 1) status bit will also be set at the same time as the Running status. The "Running" bit will remain set while the drive's control loops are active and during a controlled stop. The "Running" bit will be clear due to any of the following conditions: drive stopped, drive coast stop, drive jogging, drive autotuning.</p> <p>Bit 17 "Jogging" – This bit indicates that the drive has successfully responded to a jog signal. The "Active" (Bit 1) status bit will also be set at the same time as the Jogging status. The "Jogging" bit will remain set while the drive's control loops are active and during a controlled stop. The "Jogging" bit will remain set after the jog signal is removed until the drive is stopped. The "Jogging" bit will be clear due to any of the following conditions: drive stopped, drive coast stop, drive running, drive autotuning.</p> <p>Bit 18 "Stopping" – Drive is attempting to bring the motor to rest due to a Stop command.</p> <p>Bit 19 "DC Braking" – Drive is performing DC Braking.</p> <p>Bit 20 "DB Active" – The Dynamic Brake is active.</p> <p>Bit 21 "Speed Mode" – When set, the "Speed Mode" bit indicates that motor speed is the active regulation mode. This is the default case when operating in non-vector control mode, since position and torque can only be controlled in vector control mode. The "Speed Mode" status bit will clear due to any of the following conditions: drive operating in another regulation mode such as a position regulator, torque regulator, adjustable voltage control mode. The "Speed Mode" status bit will also clear if the drive is not active (status bit 1 clear).</p> <p>In cases where the control can automatically switch between speed and torque, such as SLAT FVC control modes, the "Speed Mode" bit will indicate when speed control is active. In the "Sum" FVC control mode where the speed regulator's output is added to a torque reference, both the "Speed Mode" and "Torque Mode" status bits will become set while the drive is active.</p> <p>Bit 22 "PositionMode" – When set, the "PositionMode" bit indicates that motor position is the active regulation mode. Position control is only available when the drive is operating in a vector control mode with a speed and position feedback device. The "Position Mode" status bit will clear due to any of the following conditions: drive operating in a non-position regulation mode such as a speed regulator, torque regulator, adjustable voltage control mode. The "PositionMode" status bit will also clear if the drive is not active (status Bit 1 clear).</p> <p>Bit 23 "Torque Mode" – When set, the "Torque Mode" bit indicates that motor torque is the active regulation mode. Torque control is only available when the drive is operating in a vector control mode. The "Torque Mode" status bit will clear due to any of the following conditions: drive operating in another regulation mode such as a speed regulator, position regulator, adjustable voltage control mode. The "Torque Mode" status bit will also clear if the drive is not active (status Bit 1 clear).</p> <p>In cases where the control can automatically switch between speed and torque, such as SLAT FVC control modes, the "Torque Mode" bit will indicate when torque control is active. In the "Sum" FVC control mode where the speed regulator's output is added to a torque reference, both the "Speed Mode" and "Torque Mode" status bits will become set while the drive is active.</p> <p>Bit 24 "AtZero Speed" – When set, the "AtZero Speed" status bit indicates that the value of P131 [Active Vel Fdbk] is near zero. This status bit is set when the feedback speed magnitude (sign independent) becomes less than the level set in P525 [Zero Speed Limit]. This bit will clear when the speed exceeds twice the zero speed level.</p> <p>Bit 25 "At Home" – This bit is set when the difference between P847 [Psn Fdbk] and P737 [Actual Home Psn] is within P726 [In Pos Psn Band].</p> <p>Bit 26 "At Limit" – This bit is set when a bit in P945 [At Limit Status] is set. See P945 [At Limit Status] for more details.</p> <p>Bit 27 "Cur Limit" – This bit is set when the drive is running with limited speed or torque avoid an overcurrent condition.</p> <p>Bit 28 "Bus Frq Reg" – This bit is set when the speed has been regulate to avoid an overcurrent condition.</p> <p>Bit 29 "Enable On" – This bit is set when the drive is enabled.</p> <p>Bit 30 "Motor OL" – This bit is set when an excessive motor load exists.</p> <p>Bit 31 "Regen" – This bit is set when the motor torque direction is opposite of the speed direction.</p>			

File	Group	No.	Display Name Full Name Description	Values	Read-Write	Data Type																													
DIAGNOSTICS	Status	936	<b>Drive Status 2</b> Drive Status 2 Present operating condition of the drive.		RO	32-bit Integer																													
		Options																																	
			Reserved	Reserved	Reserved	Reserved	Reserved	Reserved	Reserved	Reserved	Reserved	Reserved	Reserved	Reserved	Reserved	Reserved	Reserved	Reserved	AutClrCntDwn	AutoClr Act	N-1 Operate (1)	Decel Rate (2)	Accel Rate (2)	PID FB Loss	Autotuning	PrchrgClosed	Adj VltgMode (2)	Reserved	FdbkLoss Sw0	Flux Braking	Reserved	HS Fan On	AuRstrCntDwn	AutoRstr Act	
		Default	0	0	0	0	0	0	0	0	0	0	0	0	0	0	0	0	0	0	0	0	0	0	0	0	0	0	0	0	0	0	0	0	0
		Bit	31	30	29	28	27	26	25	24	23	22	21	20	19	18	17	16	15	14	13	12	11	10	9	8	7	6	5	4	3	2	1	0	
		(1) 755 Frame 8 drives and larger only. <span style="float: right;">0 = Condition False</span> (2) 753 drives only. <span style="float: right;">1 = Condition True</span>																																	
		Bit 0 "AutoRstr Act" – Auto Restart has been activated. Bit 1 "AuRstrCntDwn" – Auto Restart is counting down the delay time programmed to attempt a restart. Bit 2 "HS Fan On" – Heatsink fan is running. Bit 4 "Flux Braking" – Bit 5 "FdbkLoss Sw0" – This status bit will indicate that a F97 "Auto Tach Switch" fault has occurred. The F97 fault is associated with the option to automatically switch to the alternate feedback device upon failure of the primary device. The F97 fault indicates that both primary and alternate devices have failed. This could occur either before or after the switchover to the alternate device. Bit 7 "Adj VltgMode" – Invalid parameter selection detected. Bit 8 "PrchrgClosed" – Precharge relay is closed. Bit 9 "Autotuning" – Drive is running an Autotune procedure. Bit 10 "PID FB Loss" – The feedback selected for the PID feedback source has detected a Loss condition. The analog feedback signal of Process PID is below 2V (0...10V signal) or below 4 mA (4...20 mA signal). Bit 11 "Accel Rate" – When set, indicates that P536 [Accel Time 2] is active. This is the acceleration time from zero to rated frequency/speed for the speed control's reference ramp. When clear, indicates that P535 [Accel Time 1] is active. Accel Time 1 is the default selection. Bit 12 "Decel Rate" – When set, indicates that P538 [Decel Time 2] is active. This is the deceleration time from rated frequency/speed to zero for the speed control's reference ramp. When clear, indicates that P537 [Decel Time 1] is active. Decel Time 1 is the default selection. Bit 13 "N-1 Operate" – Indicates the parallel drive is in operation mode. Bit 14 "AutoClr Act" – set when an Auto clearable fault is detected & cleared when P339 [AutoClrFlt Delay] expires. Bit 15 "AutClrCntDwn" – set when P339 [Auto ClrFltDelay] expires & cleared when this timer expires a <START> input/fault condition (auto-clearable or trippable).																																	

File	Group	No.	Display Name Full Name Description	Values	Read-Write	Data Type																																																																																												
DIAGNOSTICS	Status	937	<b>Condition Sts 1</b> Condition Status 1  Status of conditions that may or may not result in the drive taking action (faulting), based on configuration of protective functions. The occurrence of conditions that have been configured as faults are indicated by P952 [Fault Status A] and those configured as alarms are indicated by P959 [Alarm Status A].  Options		RO	32-bit Integer																																																																																												
			<table border="1"> <thead> <tr> <th>Options</th> <th>Reserved</th> <th>Reserved</th> <th>Reserved</th> <th>Reserved</th> <th>Reserved</th> <th>Reserved</th> <th>Reserved</th> <th>Reserved</th> <th>Reserved</th> <th>Reserved</th> <th>Reserved</th> <th>Reserved</th> <th>Reserved</th> <th>Reserved</th> <th>Reserved</th> <th>OW Timeout (1)</th> <th>GndWarning</th> <th>ExtPrchrgErr</th> <th>PosFdbkLoss</th> <th>AuxFdbkLoss</th> <th>AltFdbkLoss</th> <th>PriFdbkLoss</th> <th>Shear Pin 2</th> <th>Shear Pin 1</th> <th>Decel Inhib</th> <th>OutPhaseLoss</th> <th>InPhaseLoss</th> <th>Load Loss</th> <th>Motor OL</th> <th>UnderVoltage</th> <th>Power Loss</th> </tr> </thead> <tbody> <tr> <td>Default</td> <td>0</td> <td>0</td> <td>0</td> <td>0</td> <td>0</td> <td>0</td> <td>0</td> <td>0</td> <td>0</td> <td>0</td> <td>0</td> <td>0</td> <td>0</td> <td>0</td> <td>0</td> <td>0</td> <td>0</td> <td>0</td> <td>0</td> <td>0</td> <td>0</td> <td>0</td> <td>0</td> <td>0</td> <td>0</td> <td>0</td> <td>0</td> <td>0</td> <td>0</td> <td>0</td> <td>0</td> </tr> <tr> <td>Bit</td> <td>31</td> <td>30</td> <td>29</td> <td>28</td> <td>27</td> <td>26</td> <td>25</td> <td>24</td> <td>23</td> <td>22</td> <td>21</td> <td>20</td> <td>19</td> <td>18</td> <td>17</td> <td>16</td> <td>15</td> <td>14</td> <td>13</td> <td>12</td> <td>11</td> <td>10</td> <td>9</td> <td>8</td> <td>7</td> <td>6</td> <td>5</td> <td>4</td> <td>3</td> <td>2</td> <td>1</td> <td>0</td> </tr> </tbody> </table> <p>(1) 753 drives only</p> <p style="text-align: right;">0 = Condition False 1 = Condition True</p> <p>Bit 0 "Power Loss" – A Power Loss exception has been issued. Power Loss detection is a function of the bus manager and is configured by [Pwr Loss Mode <i>n</i>] and [Pwr Loss <i>n</i> Level]. The corresponding fault and alarm are processed in the background according to P449 [Power Loss Actn] and the state of this bit.</p> <p>Bit 1 "UnderVoltage" – An Under Voltage exception has been issued. Parameter 460 [Undervltg Action] must be set to an option other than 0 "Ignore" for this bit to be set. The corresponding fault and alarm are processed immediately within the same precharge function where the condition status bit is detected.</p> <p>Bit 2 "Motor OL" – An excessive motor load exists. If P410 [Motor OL Actn] is set to option 0 "Ignore" the overload function will not produce a condition status bit, alarm status, or fault status. If P410 [Motor OL Actn] is set to option 1 "Alarm" the condition status bit and alarm will be set when the overload value exceeds P412 [Mtr OL Alarm Lvl]. Parameter 412 [Mtr OL Alarm Lvl] must be set to an option other than 0 "Ignore" to produce a condition status bit alarm.</p> <p>Bit 3 "Load Loss" – This bit dependent on the setting of P441 [Load Loss Action] which must be set to an option other than 0 "Ignore" to be processed. The corresponding fault and alarm are processed in the background according to P441 [Load Loss Action] and the state of this bit.</p> <p>Bit 4 "InPhaseLoss" – Input Phase Loss exception has been issued. The corresponding fault and alarm are processed in the background according to P462 [InPhase LossActn] and the state of this bit. Parameter 462 [InPhase LossActn] is not used to inhibit this bit.</p> <p>Bit 5 "OutPhaseLoss" – Output Phase Loss exception has been issued. The corresponding fault and alarm are processed in the background according to P444 [OutPhaseLossActn] and the state of this bit. Parameter 444 [OutPhaseLossActn] is not used to inhibit this bit.</p> <p>Bit 6 "Decel Inhib" – The drive is being Inhibited from decelerating to the commanded speed. If the drive is not decelerating (P935 [Drive Status 1] Bit 5 = 0), is not in the Run state, or if P635 [Spd Options Ctrl] Bit 0 = 1, this bit is cleared. Otherwise this bit is set when a decel inhibit condition is detected. Parameter 409 [Dec Inhibit Actn] has no effect on this bit.</p> <p>Bit 7 "Shear Pin 1" – Value set in P436 [Shear Pin1 Level] has been reached or exceeded. Parameter 435 [Shear Pin 1 Actn] must be set to an option other than 0 "Ignore" for this bit to be set. The corresponding fault and alarm are processed in the background according to P435 [Shear Pin 1 Actn] and the state of this bit.</p> <p>Bit 8 "Shear Pin 2" – Value set in P439 [Shear Pin2 Level] has been reached or exceeded. Parameter 438 [Shear Pin 2 Actn] must be set to an option other than 0 "Ignore" for this bit to be set. The corresponding fault and alarm are processed in the background according to P438 [Shear Pin 2 Actn] and the state of this bit.</p> <p>Bit 9 "PriFdbkLoss" – When set, indicates that the device selected as the primary velocity feedback source has reported a device failure. P125 [Pri Vel Fdbk Sel] selects the device used as the primary velocity feedback source. The primary feedback device supplies motor speed feedback if the Automatic Tach Switchover option is either disabled or has not switched to the alternate feedback device. In order to report this condition as an alarm, the feedback loss configuration parameter for the primary feedback device must be configured for "Alarm."</p> <p>Bit 10 "AltFdbkLoss" – When set, indicates that the device selected as the alternate velocity feedback source has reported a device failure. P128 [Alt Vel Fdbk Sel] selects the device used as the alternate velocity feedback source. The alternate feedback device supplies motor speed feedback if the Automatic Tach Switchover option is enabled and the primary feedback device has failed. In order to report this condition as an alarm, the feedback loss configuration parameter for the alternate feedback device must be configured for "Alarm."</p> <p>Bit 11 "AuxFdbkLoss" – When set, indicates that the device selected as the auxiliary velocity feedback source has reported a device failure. P132 [Aux Vel Fdbk Sel] selects the device used as the auxiliary velocity feedback source. The auxiliary feedback device can be used to supply motor speed reference. In order to report this condition as an alarm, the feedback loss configuration parameter for the auxiliary feedback device must be configured for "Alarm."</p> <p>Bit 12 "PosFdbkLoss" – When set, indicates that the device selected as the position feedback source has reported a device failure. P135 [Psn Fdbk Sel] selects the device used as the position feedback source. Position feedback is used for position control applications. It can be the same device used for velocity feedback or position feedback can be supplied by a separate device. In order to report this condition as an alarm, the feedback loss configuration parameter for the position feedback device must be configured for "Alarm."</p> <p>Bit 13 "ExtPrchrgErr" – Selected digital input assigned to the external Precharge Seal control, P190 [DI Prchrg Seal], is not active when the bus has stabilized. The corresponding fault and alarm are processed according to P323 [Prchrg Err Cfg] and the state of this bit.</p> <p>Bit 14 "GndWarning" – Value set in P467 [Ground Warn Lvl] has been exceeded. Parameter 466 [Ground Warn Actn] must be set to an option other than 0 "Ignore" for this bit to be set. The corresponding fault and alarm are processed in the background based on P466 [Ground Warn Actn] and the state of this bit.</p> <p>Bit 15 "OW Timeout" – The value set in P1172 [TorqAlarm Timeout] has been exceeded. This bit is set by the pump off algorithm. The corresponding fault and alarm are processed in the background based on the state of this bit.</p>	Options	Reserved	Reserved	Reserved	Reserved	Reserved	Reserved	Reserved	Reserved	Reserved	Reserved	Reserved	Reserved	Reserved	Reserved	Reserved	OW Timeout (1)	GndWarning	ExtPrchrgErr	PosFdbkLoss	AuxFdbkLoss	AltFdbkLoss	PriFdbkLoss	Shear Pin 2	Shear Pin 1	Decel Inhib	OutPhaseLoss	InPhaseLoss	Load Loss	Motor OL	UnderVoltage	Power Loss	Default	0	0	0	0	0	0	0	0	0	0	0	0	0	0	0	0	0	0	0	0	0	0	0	0	0	0	0	0	0	0	0	Bit	31	30	29	28	27	26	25	24	23	22	21	20	19	18	17	16	15	14	13	12	11	10	9	8	7	6	5	4	3	2
Options	Reserved	Reserved	Reserved	Reserved	Reserved	Reserved	Reserved	Reserved	Reserved	Reserved	Reserved	Reserved	Reserved	Reserved	Reserved	OW Timeout (1)	GndWarning	ExtPrchrgErr	PosFdbkLoss	AuxFdbkLoss	AltFdbkLoss	PriFdbkLoss	Shear Pin 2	Shear Pin 1	Decel Inhib	OutPhaseLoss	InPhaseLoss	Load Loss	Motor OL	UnderVoltage	Power Loss																																																																			
Default	0	0	0	0	0	0	0	0	0	0	0	0	0	0	0	0	0	0	0	0	0	0	0	0	0	0	0	0	0	0	0																																																																			
Bit	31	30	29	28	27	26	25	24	23	22	21	20	19	18	17	16	15	14	13	12	11	10	9	8	7	6	5	4	3	2	1	0																																																																		

File	Group	No.	Display Name Full Name Description	Values		Read-Write	Data Type
DIAGNOSTICS	Status	940	<b>Drive OL Count</b> Drive Overload Count Indicates power unit overload (IT) in percentage. When the value reaches 100%, the power unit overload fault occurs.	Units: % Default: 0.00 Min/Max: 0.00 / 200.00		RO	Real
		941	<b>IGBT Temp Pct</b> Insulated-Gate Bipolar Transistor Temperature Percent Indicates IGBT junction temperature in percentage of the maximum junction temperature. The value of this parameter is calculated.	Units: % Default: 0.00 Min/Max: -/+200.00		RO	Real
		942	<b>IGBT Temp C</b> Insulated-Gate Bipolar Transistor Temperature Celsius Indicates IGBT junction temperature in centigrade. The value of this parameter is calculated.	Units: DegC Default: 0.00 Min/Max: -/+200.00		RO	Real
		943	<b>Drive Temp Pct</b> Drive Temperature Percent Indicates operating temperature of the drive power section (heat-sink) in percentage of the maximum heat-sink temperature. The value of this parameter is measured.	Units: % Default: 0.00 Min/Max: -/+200.00		RO	Real
		944	<b>Drive Temp C</b> Drive Temperature Celsius Present operating temperature of the drive power section. The value of this parameter is measured.	Units: DegC Default: 0.00 Min/Max: -/+200.00		RO	Real



File	Group	No.	Display Name Full Name Description	Values	Read-Write	Data Type																																																																																																		
DIAGNOSTICS	Status	945	<b>At Limit Status</b> At Limit Status Status of dynamic conditions within the drive that are either active or a limit is being applied.  Options <table border="1"> <thead> <tr> <th></th> <th>Cur Rate Lmt</th> <th>TrqPrvNegLmt</th> <th>TrqPrvPosLmt</th> <th>Mtr Vltg Lkg</th> <th>BusVltgFVLmt</th> <th>Therm RegLmt</th> <th>Cur Lmt FV</th> <th>Regen PwrLmt</th> <th>Mtrng PwrLmt</th> <th>Trq Neg Lmt</th> <th>Trq Pos Lmt</th> <th>FlxCurNegLmt</th> <th>FlxCurPosLmt</th> <th>TrqCurNegLmt</th> <th>TrqCurPosLmt</th> <th>PsnReg HiSpd</th> <th>PsnReg LoSpd</th> <th>PsnReg HiLmt</th> <th>PsnReg LoLmt</th> <th>DB Res Limit</th> <th>PWM FreqLmt</th> <th>Economize</th> <th>Flux Braking</th> <th>FreqOSNegLmt</th> <th>FreqOSPosLmt</th> <th>Freq Lo Lmt</th> <th>Freq Hi Lmt</th> <th>Spd Reg Lmt</th> <th>OverSpd Lmt</th> <th>MaxSpeed Lmt</th> <th>Bus Vltg Lmt</th> <th>Current Lmt</th> </tr> </thead> <tbody> <tr> <td>Default</td> <td>0</td><td>0</td><td>0</td><td>0</td><td>0</td><td>0</td><td>0</td><td>0</td><td>0</td><td>0</td><td>0</td><td>0</td><td>0</td><td>0</td><td>0</td><td>0</td><td>0</td><td>0</td><td>0</td><td>0</td><td>0</td><td>0</td><td>0</td><td>0</td><td>0</td><td>0</td><td>0</td><td>0</td><td>0</td><td>0</td><td>0</td><td>0</td> </tr> <tr> <td>Bit</td> <td>31</td><td>30</td><td>29</td><td>28</td><td>27</td><td>26</td><td>25</td><td>24</td><td>23</td><td>22</td><td>21</td><td>20</td><td>19</td><td>18</td><td>17</td><td>16</td><td>15</td><td>14</td><td>13</td><td>12</td><td>11</td><td>10</td><td>9</td><td>8</td><td>7</td><td>6</td><td>5</td><td>4</td><td>3</td><td>2</td><td>1</td><td>0</td> </tr> </tbody> </table> <p style="text-align: right;">0 = Condition False 1 = Condition True</p> <p>Bit 0 "Current Lmt" – Scalar current limit is adjusting the output frequency                      Bit 1 "Bus Vltg Lmt" – Scalar bus voltage limit is adjusting the output frequency                      Bit 2 "MaxSpeed Lmt" – Motor speed reference is limited to maximum forward speed or maximum reverse speed. See P520 [Max Fwd Speed], P521 [Max Rev Speed].                      Bit 3 "OverSpd Lmt" – Motor speed reference positive (+) trim is at maximum speed limit plus or minus (+/-) the overspeed limit                      Bit 4 "Spd Reg Lmt" – The output of the drive's speed regulator has reached limit. See P655 [Spd Reg Pos Lmt], P656 [Spd Reg Neg Lmt].                      Bit 5 "Freq Hi Lmt" – Scalar control inner ramp high limit is active                      Bit 6 "Freq Lo Lmt" – Scalar control inner ramp low limit is active                      Bit 7 "FreqOSPosLmt" – Scalar control inner ramp positive (+) overspeed limit is active                      Bit 8 "FreqOSNegLmt" – Scalar control inner ramp negative (-) overspeed limit is active                      Bit 9 "Flux Braking" – Flux braking is active                      Bit 10 "Economize" – Economize is active                      Bit 11 "PWM FreqLmt" – PWM frequency is reduced by the thermal regulator                      Bit 12 "DB Res Limit" – Dynamic brake thermal protection is active. Verify P385 [DB ExtPulseWatts].                      Bit 13 "PsnReg LoLmt" – The position integrator low limit is active                      Bit 14 "PsnReg HiLmt" – The position integrator high limit is active                      Bit 15 "PsnReg LoSpd" – The position regulator output (speed) is at low limit                      Bit 16 "PsnReg HiSpd" – The position regulator output (speed) is at high limit                      Bit 17 "TrqCurPosLmt" – The torque current positive limit is active                      Bit 18 "TrqCurNegLmt" – The torque current negative limit is active                      Bit 19 "FlxCurPosLmt" – The flux current positive limit is active                      Bit 20 "FlxCurNegLmt" – The flux current negative limit is active                      Bit 21 "Trq Pos Lmt" – The positive torque limit is active. See P670 [Pos Torque Limit].                      Bit 22 "Trq Neg Lmt" – The negative torque limit is active. See P671 [Neg Torque Limit].                      Bit 23 "Mtrng PwrLmt" – The motoring power limit is active. See P427 [Motor Power Lmt].                      Bit 24 "Regen PwrLmt" – The regeneration power limit is active. See P426 [Regen Power Lmt].                      Bit 25 "Cur Lmt FV" – The current limit parameter or analog Input current limit is active                      Bit 26 "Therm RegLmt" – The thermal regulator torque limit is active                      Bit 27 "BusVltgFVLmt" – The bus voltage regulator torque limit is active                      Bit 28 "Mtr Vltg Lkg" – The Vds motor voltage limit is active                      Bit 29 "TrqPrvPosLmt" – The torque proving positive torque limit is active                      Bit 30 "TrqPrvNegLmt" – The torque proving negative torque limit is active                      Bit 31 "Cur Rate Lmt" – The Iqs rate limit is active</p>		Cur Rate Lmt	TrqPrvNegLmt	TrqPrvPosLmt	Mtr Vltg Lkg	BusVltgFVLmt	Therm RegLmt	Cur Lmt FV	Regen PwrLmt	Mtrng PwrLmt	Trq Neg Lmt	Trq Pos Lmt	FlxCurNegLmt	FlxCurPosLmt	TrqCurNegLmt	TrqCurPosLmt	PsnReg HiSpd	PsnReg LoSpd	PsnReg HiLmt	PsnReg LoLmt	DB Res Limit	PWM FreqLmt	Economize	Flux Braking	FreqOSNegLmt	FreqOSPosLmt	Freq Lo Lmt	Freq Hi Lmt	Spd Reg Lmt	OverSpd Lmt	MaxSpeed Lmt	Bus Vltg Lmt	Current Lmt	Default	0	0	0	0	0	0	0	0	0	0	0	0	0	0	0	0	0	0	0	0	0	0	0	0	0	0	0	0	0	0	0	0	Bit	31	30	29	28	27	26	25	24	23	22	21	20	19	18	17	16	15	14	13	12	11	10	9	8	7	6	5	4	3	2	1	0	RO	32-bit Integer
			Cur Rate Lmt	TrqPrvNegLmt	TrqPrvPosLmt	Mtr Vltg Lkg	BusVltgFVLmt	Therm RegLmt	Cur Lmt FV	Regen PwrLmt	Mtrng PwrLmt	Trq Neg Lmt	Trq Pos Lmt	FlxCurNegLmt	FlxCurPosLmt	TrqCurNegLmt	TrqCurPosLmt	PsnReg HiSpd	PsnReg LoSpd	PsnReg HiLmt	PsnReg LoLmt	DB Res Limit	PWM FreqLmt	Economize	Flux Braking	FreqOSNegLmt	FreqOSPosLmt	Freq Lo Lmt	Freq Hi Lmt	Spd Reg Lmt	OverSpd Lmt	MaxSpeed Lmt	Bus Vltg Lmt	Current Lmt																																																																						
Default	0	0	0	0	0	0	0	0	0	0	0	0	0	0	0	0	0	0	0	0	0	0	0	0	0	0	0	0	0	0	0	0																																																																								
Bit	31	30	29	28	27	26	25	24	23	22	21	20	19	18	17	16	15	14	13	12	11	10	9	8	7	6	5	4	3	2	1	0																																																																								
		946	<b>Safety Port Sts</b> Safety Port Status Indicates the port location of a valid feedback option for use with the Safe Speed Monitoring Option.  Options <table border="1"> <thead> <tr> <th></th> <th>Reserved</th> <th>Reserved</th> <th>Reserved</th> <th>Reserved</th> <th>Reserved</th> <th>Reserved</th> <th>Reserved</th> <th>Reserved</th> <th>Port 8</th> <th>Port 7</th> <th>Port 6</th> <th>Port 5</th> <th>Port 4</th> <th>Reserved</th> <th>Reserved</th> <th>Reserved</th> <th>Reserved</th> </tr> </thead> <tbody> <tr> <td>Default</td> <td>0</td><td>0</td><td>0</td><td>0</td><td>0</td><td>0</td><td>0</td><td>0</td><td>0</td><td>0</td><td>0</td><td>0</td><td>0</td><td>0</td><td>0</td><td>0</td><td>0</td> </tr> <tr> <td>Bit</td> <td>15</td><td>14</td><td>13</td><td>12</td><td>11</td><td>10</td><td>9</td><td>8</td><td>7</td><td>6</td><td>5</td><td>4</td><td>3</td><td>2</td><td>1</td><td>0</td><td>0</td> </tr> </tbody> </table> <p style="text-align: right;">0 = Condition False 1 = Condition True</p>		Reserved	Reserved	Reserved	Reserved	Reserved	Reserved	Reserved	Reserved	Port 8	Port 7	Port 6	Port 5	Port 4	Reserved	Reserved	Reserved	Reserved	Default	0	0	0	0	0	0	0	0	0	0	0	0	0	0	0	0	0	Bit	15	14	13	12	11	10	9	8	7	6	5	4	3	2	1	0	0	RO	16-bit Integer																																													
	Reserved	Reserved	Reserved	Reserved	Reserved	Reserved	Reserved	Reserved	Port 8	Port 7	Port 6	Port 5	Port 4	Reserved	Reserved	Reserved	Reserved																																																																																							
Default	0	0	0	0	0	0	0	0	0	0	0	0	0	0	0	0	0																																																																																							
Bit	15	14	13	12	11	10	9	8	7	6	5	4	3	2	1	0	0																																																																																							

File	Group	No.	Display Name Full Name Description	Values	Read-Write	Data Type																																																																																																			
DIAGNOSTICS	Fault/Alarm Info	950	<b>Minor Flt Cfg</b> Minor Fault Configuration  Enables / Disables operation of the "Minor Fault" function, which allows the drive to continue running while some types of faults are present. In addition to setting this parameter, the "Flt Minor" action must be selected for the condition that is desired to result in a minor fault (see P410 [Motor OL Actn] for an example).  Options		RW	16-bit Integer																																																																																																			
			<table border="1"> <thead> <tr> <th>Reserved</th><th>Reserved</th><th>Reserved</th><th>Reserved</th><th>Reserved</th><th>Reserved</th><th>Reserved</th><th>Reserved</th><th>Reserved</th><th>Reserved</th><th>Reserved</th><th>Reserved</th><th>Reserved</th><th>Reserved</th><th>Reserved</th><th>Enable</th> </tr> </thead> <tbody> <tr> <td>0</td><td>0</td><td>0</td><td>0</td><td>0</td><td>0</td><td>0</td><td>0</td><td>0</td><td>0</td><td>0</td><td>0</td><td>0</td><td>0</td><td>0</td><td>0</td> </tr> <tr> <td>Bit</td><td>15</td><td>14</td><td>13</td><td>12</td><td>11</td><td>10</td><td>9</td><td>8</td><td>7</td><td>6</td><td>5</td><td>4</td><td>3</td><td>2</td><td>1</td><td>0</td> </tr> </tbody> </table>	Reserved	Reserved	Reserved	Reserved	Reserved	Reserved	Reserved	Reserved	Reserved	Reserved	Reserved	Reserved	Reserved	Reserved	Reserved	Enable	0	0	0	0	0	0	0	0	0	0	0	0	0	0	0	0	Bit	15	14	13	12	11	10	9	8	7	6	5	4	3	2	1	0	0 = Condition False 1 = Condition True																																																				
		Reserved	Reserved	Reserved	Reserved	Reserved	Reserved	Reserved	Reserved	Reserved	Reserved	Reserved	Reserved	Reserved	Reserved	Reserved	Enable																																																																																								
0	0	0	0	0	0	0	0	0	0	0	0	0	0	0	0																																																																																										
Bit	15	14	13	12	11	10	9	8	7	6	5	4	3	2	1	0																																																																																									
		951	<b>Last Fault Code</b> Last Fault Code  The fault code of the first fault since the last reset. There is often a chain of faults that occur during a breakdown. When troubleshooting, it is often helpful to know the first fault. This parameter is for convenience. A comprehensive history of fault information is available through the fault que (via HIM screens and / or software tools such as Drive Explorer).	Default: 0 Min/Max: 0 / 424648720	RO	32-bit Integer																																																																																																			
		952	<b>Fault Status A</b> Fault Status A  Indicates the occurrence of conditions that have been configured as faults. These conditions are from 937 [Condition Sts 1]. See parameter 937 [Condition Sts 1] for bit descriptions.  Options		RO	32-bit Integer																																																																																																			
			<table border="1"> <thead> <tr> <th>Reserved</th><th>Reserved</th><th>Reserved</th><th>Reserved</th><th>Reserved</th><th>Reserved</th><th>Reserved</th><th>Reserved</th><th>Reserved</th><th>Reserved</th><th>Reserved</th><th>Reserved</th><th>Reserved</th><th>Reserved</th><th>Reserved</th><th>Reserved</th><th>Reserved</th><th>Reserved</th><th>Reserved</th><th>ExtPrchngErr</th><th>PosFdbkLoss</th><th>AuxFdbkLoss</th><th>AltFdbkLoss</th><th>PrfFdbkLoss</th><th>Shear Pin 2</th><th>Shear Pin 1</th><th>Decel Inhib</th><th>OutPhaseLoss</th><th>InPhaseLoss</th><th>Load Loss</th><th>Motor OL</th><th>UnderVoltage</th><th>Power Loss</th> </tr> </thead> <tbody> <tr> <td>0</td><td>0</td><td>0</td><td>0</td><td>0</td><td>0</td><td>0</td><td>0</td><td>0</td><td>0</td><td>0</td><td>0</td><td>0</td><td>0</td><td>0</td><td>0</td><td>0</td><td>0</td><td>0</td><td>0</td><td>0</td><td>0</td><td>0</td><td>0</td><td>0</td><td>0</td><td>0</td><td>0</td><td>0</td><td>0</td><td>0</td><td>0</td><td>0</td> </tr> <tr> <td>Bit</td><td>31</td><td>30</td><td>29</td><td>28</td><td>27</td><td>26</td><td>25</td><td>24</td><td>23</td><td>22</td><td>21</td><td>20</td><td>19</td><td>18</td><td>17</td><td>16</td><td>15</td><td>14</td><td>13</td><td>12</td><td>11</td><td>10</td><td>9</td><td>8</td><td>7</td><td>6</td><td>5</td><td>4</td><td>3</td><td>2</td><td>1</td><td>0</td> </tr> </tbody> </table>	Reserved	Reserved	Reserved	Reserved	Reserved	Reserved	Reserved	Reserved	Reserved	Reserved	Reserved	Reserved	Reserved	Reserved	Reserved	Reserved	Reserved	Reserved	Reserved	ExtPrchngErr	PosFdbkLoss	AuxFdbkLoss	AltFdbkLoss	PrfFdbkLoss	Shear Pin 2	Shear Pin 1	Decel Inhib	OutPhaseLoss	InPhaseLoss	Load Loss	Motor OL	UnderVoltage	Power Loss	0	0	0	0	0	0	0	0	0	0	0	0	0	0	0	0	0	0	0	0	0	0	0	0	0	0	0	0	0	0	0	0	0	Bit	31	30	29	28	27	26	25	24	23	22	21	20	19	18	17	16	15	14	13	12	11	10	9	8	7	6	5	4	3	2	1	0	0 = Condition False 1 = Condition True		
Reserved	Reserved	Reserved	Reserved	Reserved	Reserved	Reserved	Reserved	Reserved	Reserved	Reserved	Reserved	Reserved	Reserved	Reserved	Reserved	Reserved	Reserved	Reserved	ExtPrchngErr	PosFdbkLoss	AuxFdbkLoss	AltFdbkLoss	PrfFdbkLoss	Shear Pin 2	Shear Pin 1	Decel Inhib	OutPhaseLoss	InPhaseLoss	Load Loss	Motor OL	UnderVoltage	Power Loss																																																																									
0	0	0	0	0	0	0	0	0	0	0	0	0	0	0	0	0	0	0	0	0	0	0	0	0	0	0	0	0	0	0	0	0																																																																									
Bit	31	30	29	28	27	26	25	24	23	22	21	20	19	18	17	16	15	14	13	12	11	10	9	8	7	6	5	4	3	2	1	0																																																																									

File Group	No.	Display Name Full Name Description	Values	Read-Write	Data Type																																																																																																		
DIAGNOSTICS Fault/Alarm Info	953	<b>Fault Status B</b> Fault Status B Indicates the occurrence of conditions that have been configured as faults.  Options <table border="1"> <thead> <tr> <th></th> <th>Reserved</th> <th>Reserved</th> <th>Reserved</th> <th>Reserved</th> <th>Reserved</th> <th>Reserved</th> <th>Reserved</th> <th>Reserved</th> <th>Reserved</th> <th>End Lmt Sw</th> <th>TrvlLimCflct</th> <th>Over Travel</th> <th>OW Alarm TO</th> <th>Ground Fault</th> <th>TPEnclsCfg (1)</th> <th>TrqPrvSpdBnd (1)</th> <th>HW OverCur</th> <th>SW OverCur</th> <th>AuRstExhaust</th> <th>IXOVoltRange</th> <th>FluxAmpsRang</th> <th>IRVoltsRange</th> <th>SafetyBrdFlt</th> <th>Prchrg Open</th> <th>Overspd Lmt</th> <th>Excess Load</th> <th>SinkUnderTmp</th> <th>TransistorOT</th> <th>Heatsink OT</th> <th>Drive OL</th> <th>OverVoltage</th> <th>Aux InputFlt</th> </tr> </thead> <tbody> <tr> <td>Default</td> <td>0</td> <td>0</td> <td>0</td> <td>0</td> <td>0</td> <td>0</td> <td>0</td> <td>0</td> <td>0</td> <td>0</td> <td>0</td> <td>0</td> <td>0</td> <td>0</td> <td>0</td> <td>0</td> <td>0</td> <td>0</td> <td>0</td> <td>0</td> <td>0</td> <td>0</td> <td>0</td> <td>0</td> <td>0</td> <td>0</td> <td>0</td> <td>0</td> <td>0</td> <td>0</td> <td>0</td> <td>0</td> </tr> <tr> <td>Bit</td> <td>31</td> <td>30</td> <td>29</td> <td>28</td> <td>27</td> <td>26</td> <td>25</td> <td>24</td> <td>23</td> <td>22</td> <td>21</td> <td>20</td> <td>19</td> <td>18</td> <td>17</td> <td>16</td> <td>15</td> <td>14</td> <td>13</td> <td>12</td> <td>11</td> <td>10</td> <td>9</td> <td>8</td> <td>7</td> <td>6</td> <td>5</td> <td>4</td> <td>3</td> <td>2</td> <td>1</td> <td>0</td> </tr> </tbody> </table> <p>(1) 755 drives only. <span style="float: right;">0 = Condition False 1 = Condition True</span></p> <p>Bit 0 "Aux InputFlt" –</p> <p>Bit 1 "OverVoltage" – Over voltage trip occurred.</p> <p>Bit 2 "Drive OL" – Indicates the drive is overloaded. P940 [Drive OL Count] reached 100%.</p> <p>Bit 3 "Heatsink OT" – Indicates the drive heatsink is over temperature. P943 [Drive Temp Pct] reached 100%.</p> <p>Bit 4 "TransistorOT" – Indicates the transistor (IGBT) junction is over temperature. P941 [IGBT Temp Pct] reached 100%.</p> <p>Bit 5 "SinkUnderTmp" – Indicates the heatsink temperature is under -18.7 °C (-2 °F).</p> <p>Bit 6 "Excess Load" – Motor did not come up to speed in the allotted time during autotune.</p> <p>Bit 7 "Overspd Lmt" – When set, indicates that a F25 "OverSpeed Limit" fault has occurred. This is a non-configurable fault. An overspeed condition results when the motor speed falls outside of its normal operating range. The limits of this range are established by P521 [Max Rev Speed] - P524 [Overspeed Limit] = (lower limit) and P520 [Max Fwd Speed] + P524 [Overspeed Limit] = (upper limit). In flux vector control mode or scalar control mode with encoder, the motor speed used is a 2msec averaged value of P131 [Active Vel Fdbk]. In scalar control mode without an encoder, the overspeed check uses P1 [Output Frequency]. The overspeed condition must exist for at least 16 milliseconds before it causes a fault to occur.</p> <p>Bit 8 "Prchrg Open" – Precharge relay is open.</p> <p>Bit 9 "SafetyBrdFlt" – Safety board is in a faulted state.</p> <p>Bit 10 "IRVoltsRange" – The Autotune IR voltage exceeded the range of P73 [IR Voltage Drop].</p> <p>Bit 11 "FluxAmpsRang" – The Autotune Flux Current exceeded the range of P75 [Flux Current Ref].</p> <p>Bit 12 "IXOVoltRange" – The Autotune Ixo voltage exceeded the range of P74 [Ixo Voltage Drop].</p> <p>Bit 13 "AuRstExhaust" – The value set in P348 [Auto Rstrt Tries] has been exceeded.</p> <p>Bit 14 "SW OverCur" – Drive output current has exceeded the 1ms 250% current rating.</p> <p>Bit 15 "HW OverCur" – Drive output current has exceeded the hardware current trip limit.</p> <p>Bit 16 "TrqPrvSpdBnd" – The allowable deviation between actual motor speed and ramped speed set in P1105 [Speed Dev Band] has been exceeded.</p> <p>Bit 17 "TPEnclsCfg" – The Torque Proving function has been configured as Encoderless. Read the Attention statement under Lifting/Torque Proving on <a href="#">page 372</a>.</p> <p>Bit 18 "Ground Fault" – Current path to earth ground greater than 25% drive rated current detected.</p> <p>Bit 19 "OW Alarm TO" – An A65 "OW TrqLvl Timeout" alarm has occurred.</p> <p>Bit 20 "Over Travel" – The selected digital input for one of the over travel directions is active.</p> <p>Bit 21 "TrvlLimCflct" – Travel limits are in conflict.</p> <p>Bit 22 "End Lmt Sw" – The selected digital input for one of the end limit switches, P196 [DI Fwd End Limit] or P198 [DI Rev End Limit], has detected a falling edge and P313 [Actv SpTqPs Mode] is not set to 1 "Speed Reg."</p>		Reserved	Reserved	Reserved	Reserved	Reserved	Reserved	Reserved	Reserved	Reserved	End Lmt Sw	TrvlLimCflct	Over Travel	OW Alarm TO	Ground Fault	TPEnclsCfg (1)	TrqPrvSpdBnd (1)	HW OverCur	SW OverCur	AuRstExhaust	IXOVoltRange	FluxAmpsRang	IRVoltsRange	SafetyBrdFlt	Prchrg Open	Overspd Lmt	Excess Load	SinkUnderTmp	TransistorOT	Heatsink OT	Drive OL	OverVoltage	Aux InputFlt	Default	0	0	0	0	0	0	0	0	0	0	0	0	0	0	0	0	0	0	0	0	0	0	0	0	0	0	0	0	0	0	0	0	Bit	31	30	29	28	27	26	25	24	23	22	21	20	19	18	17	16	15	14	13	12	11	10	9	8	7	6	5	4	3	2	1	0	RO	32-bit Integer
		Reserved	Reserved	Reserved	Reserved	Reserved	Reserved	Reserved	Reserved	Reserved	End Lmt Sw	TrvlLimCflct	Over Travel	OW Alarm TO	Ground Fault	TPEnclsCfg (1)	TrqPrvSpdBnd (1)	HW OverCur	SW OverCur	AuRstExhaust	IXOVoltRange	FluxAmpsRang	IRVoltsRange	SafetyBrdFlt	Prchrg Open	Overspd Lmt	Excess Load	SinkUnderTmp	TransistorOT	Heatsink OT	Drive OL	OverVoltage	Aux InputFlt																																																																						
Default	0	0	0	0	0	0	0	0	0	0	0	0	0	0	0	0	0	0	0	0	0	0	0	0	0	0	0	0	0	0	0	0																																																																							
Bit	31	30	29	28	27	26	25	24	23	22	21	20	19	18	17	16	15	14	13	12	11	10	9	8	7	6	5	4	3	2	1	0																																																																							
	954	<b>Status1 at Fault</b> Status 1 at Fault Captures and displays P935 [Drive Status 1] bit pattern at the time of the last fault. See parameter 935 [Drive Status 1] for bit descriptions.  Options <table border="1"> <thead> <tr> <th></th> <th>Regen</th> <th>Motor OL</th> <th>Enable On</th> <th>Bus Freq Reg</th> <th>Cur Limit</th> <th>At Limit</th> <th>At Home</th> <th>AtZero Speed</th> <th>Torque Mode</th> <th>PositionMode</th> <th>Speed Mode</th> <th>DB Active</th> <th>DC Braking</th> <th>Stopping</th> <th>Jogging</th> <th>Running</th> <th>Emrg OvrRide</th> <th>SpdRef Bit 4</th> <th>SpdRef Bit 3</th> <th>SpdRef Bit 2</th> <th>SpdRef Bit 1</th> <th>SpdRef Bit 0</th> <th>Manual</th> <th>At Speed</th> <th>Faulted</th> <th>Alarm</th> <th>Decelerating</th> <th>Accelerating</th> <th>Actual Dir</th> <th>Command Dir</th> <th>Active</th> <th>Ready</th> </tr> </thead> <tbody> <tr> <td>Default</td> <td>0</td> <td>0</td> <td>0</td> <td>0</td> <td>0</td> <td>0</td> <td>0</td> <td>0</td> <td>0</td> <td>0</td> <td>0</td> <td>0</td> <td>0</td> <td>0</td> <td>0</td> <td>0</td> <td>0</td> <td>0</td> <td>0</td> <td>0</td> <td>0</td> <td>0</td> <td>0</td> <td>0</td> <td>0</td> <td>0</td> <td>0</td> <td>0</td> <td>0</td> <td>0</td> <td>0</td> <td>0</td> </tr> <tr> <td>Bit</td> <td>31</td> <td>30</td> <td>29</td> <td>28</td> <td>27</td> <td>26</td> <td>25</td> <td>24</td> <td>23</td> <td>22</td> <td>21</td> <td>20</td> <td>19</td> <td>18</td> <td>17</td> <td>16</td> <td>15</td> <td>14</td> <td>13</td> <td>12</td> <td>11</td> <td>10</td> <td>9</td> <td>8</td> <td>7</td> <td>6</td> <td>5</td> <td>4</td> <td>3</td> <td>2</td> <td>1</td> <td>0</td> </tr> </tbody> </table> <p>0 = Condition False 1 = Condition True</p>		Regen	Motor OL	Enable On	Bus Freq Reg	Cur Limit	At Limit	At Home	AtZero Speed	Torque Mode	PositionMode	Speed Mode	DB Active	DC Braking	Stopping	Jogging	Running	Emrg OvrRide	SpdRef Bit 4	SpdRef Bit 3	SpdRef Bit 2	SpdRef Bit 1	SpdRef Bit 0	Manual	At Speed	Faulted	Alarm	Decelerating	Accelerating	Actual Dir	Command Dir	Active	Ready	Default	0	0	0	0	0	0	0	0	0	0	0	0	0	0	0	0	0	0	0	0	0	0	0	0	0	0	0	0	0	0	0	0	Bit	31	30	29	28	27	26	25	24	23	22	21	20	19	18	17	16	15	14	13	12	11	10	9	8	7	6	5	4	3	2	1	0	RO	32-bit Integer
	Regen	Motor OL	Enable On	Bus Freq Reg	Cur Limit	At Limit	At Home	AtZero Speed	Torque Mode	PositionMode	Speed Mode	DB Active	DC Braking	Stopping	Jogging	Running	Emrg OvrRide	SpdRef Bit 4	SpdRef Bit 3	SpdRef Bit 2	SpdRef Bit 1	SpdRef Bit 0	Manual	At Speed	Faulted	Alarm	Decelerating	Accelerating	Actual Dir	Command Dir	Active	Ready																																																																							
Default	0	0	0	0	0	0	0	0	0	0	0	0	0	0	0	0	0	0	0	0	0	0	0	0	0	0	0	0	0	0	0	0																																																																							
Bit	31	30	29	28	27	26	25	24	23	22	21	20	19	18	17	16	15	14	13	12	11	10	9	8	7	6	5	4	3	2	1	0																																																																							

File	Group	No.	Display Name Full Name Description	Values	Read-Write	Data Type																																																																																																					
<b>DIAGNOSTICS</b>	<b>Fault/Alarm Info</b>	955	<b>Status2 at Fault</b> Status 2 at Fault Captures and displays P936 [Drive Status 2] bit pattern at the time of the last fault. See parameter 936 [Drive Status 2] for bit descriptions.  Options		RO	32-bit Integer																																																																																																					
				<table border="1"> <tr> <td></td> <td>Reserved</td><td>Reserved</td><td>Reserved</td><td>Reserved</td><td>Reserved</td><td>Reserved</td><td>Reserved</td><td>Reserved</td><td>Reserved</td><td>Reserved</td><td>Reserved</td><td>Reserved</td><td>Reserved</td><td>Reserved</td><td>Reserved</td><td>Reserved</td><td>Reserved</td><td>Decel Rate</td><td>Accel Rate</td><td>PID FB Loss</td><td>Autotuning</td><td>PchrgClosed</td><td>Reserved</td><td>Reserved</td><td>FdbkLoss Sw0</td><td>Flux Braking</td><td>Reserved</td><td>HS Fan On</td><td>AuRstrCntrlDwn</td><td>AutoRstr Act</td> </tr> <tr> <td>Default</td> <td>0</td><td>0</td><td>0</td><td>0</td><td>0</td><td>0</td><td>0</td><td>0</td><td>0</td><td>0</td><td>0</td><td>0</td><td>0</td><td>0</td><td>0</td><td>0</td><td>0</td><td>0</td><td>0</td><td>0</td><td>0</td><td>0</td><td>0</td><td>0</td><td>0</td><td>0</td><td>0</td><td>0</td><td>0</td><td>0</td> </tr> <tr> <td>Bit</td> <td>31</td><td>30</td><td>29</td><td>28</td><td>27</td><td>26</td><td>25</td><td>24</td><td>23</td><td>22</td><td>21</td><td>20</td><td>19</td><td>18</td><td>17</td><td>16</td><td>15</td><td>14</td><td>13</td><td>12</td><td>11</td><td>10</td><td>9</td><td>8</td><td>7</td><td>6</td><td>5</td><td>4</td><td>3</td><td>2</td><td>1</td><td>0</td> </tr> </table>		Reserved	Reserved	Reserved	Reserved	Reserved	Reserved	Reserved	Reserved	Reserved	Reserved	Reserved	Reserved	Reserved	Reserved	Reserved	Reserved	Reserved	Decel Rate	Accel Rate	PID FB Loss	Autotuning	PchrgClosed	Reserved	Reserved	FdbkLoss Sw0	Flux Braking	Reserved	HS Fan On	AuRstrCntrlDwn	AutoRstr Act	Default	0	0	0	0	0	0	0	0	0	0	0	0	0	0	0	0	0	0	0	0	0	0	0	0	0	0	0	0	0	0	Bit	31	30	29	28	27	26	25	24	23	22	21	20	19	18	17	16	15	14	13	12	11	10	9	8	7	6	5	4	3	2	1	0								
			Reserved	Reserved	Reserved	Reserved	Reserved	Reserved	Reserved	Reserved	Reserved	Reserved	Reserved	Reserved	Reserved	Reserved	Reserved	Reserved	Reserved	Decel Rate	Accel Rate	PID FB Loss	Autotuning	PchrgClosed	Reserved	Reserved	FdbkLoss Sw0	Flux Braking	Reserved	HS Fan On	AuRstrCntrlDwn	AutoRstr Act																																																																											
		Default	0	0	0	0	0	0	0	0	0	0	0	0	0	0	0	0	0	0	0	0	0	0	0	0	0	0	0	0	0	0																																																																											
		Bit	31	30	29	28	27	26	25	24	23	22	21	20	19	18	17	16	15	14	13	12	11	10	9	8	7	6	5	4	3	2	1	0																																																																									
						0 = Condition False 1 = Condition True																																																																																																					
		956	<b>Fault Frequency</b> Fault Frequency Captures and displays the current value of P1 [Output Frequency], in Hertz, at the time of the last fault. Setting P300 [Speed Units] to option 1 "RPM" does not affect this parameter. For some faults, the value captured in this parameter may not match peak/low at time of fault due to data latency.	Units: Hz Default: 0.00 Min/Max: -/+ 650.00	RO	Real																																																																																																					
		957	<b>Fault Amps</b> Fault Amps Captures and displays the current value of P7 [Output Current], in Amps, at the time of the last fault. For some faults, the value captured in this parameter may not match peak/low at time of fault due to data latency.	Units: Amps Default: 0.00 Min/Max: 0.00 / P21 [Rated Amps] x 2	RO	Real																																																																																																					
		958	<b>Fault Bus Volts</b> Fault Bus Volts Captures and displays the current value of P11 [DC Bus Volts], in Volts DC, at the time of the last fault. For some faults, the value captured in this parameter may not match peak/low at time of fault due to data latency.	Units: V DC Default: 0.00 Min/Max: 0.00 / P20 [Rated Volts] x 2	RO	Real																																																																																																					
		959	<b>Alarm Status A</b> Alarm Status A Indicates the occurrence of conditions that have been configured as alarms. These events are from 937 [Condition Sts 1]. See parameter 937 [Condition Sts 1] for bit descriptions.  Options		RO	32-bit Integer																																																																																																					
				<table border="1"> <tr> <td></td> <td>Reserved</td><td>Reserved</td><td>Reserved</td><td>Reserved</td><td>Reserved</td><td>Reserved</td><td>Reserved</td><td>Reserved</td><td>Reserved</td><td>Reserved</td><td>Reserved</td><td>Reserved</td><td>Reserved</td><td>Reserved</td><td>Reserved</td><td>Reserved</td><td>Reserved</td><td>Task Overrun</td><td>Gnd Warning</td><td>Reserved</td><td>PostFdbkLoss</td><td>AuxFdbkLoss</td><td>AltFdbkLoss</td><td>PrfFdbkLoss</td><td>Shear Pin 2</td><td>Shear Pin 1</td><td>Decel Inhib</td><td>OutPhaseLoss</td><td>InPhaseLoss</td><td>Load Loss</td><td>Motor OL</td><td>UnderVoltage</td><td>Power Loss</td> </tr> <tr> <td>Default</td> <td>0</td><td>0</td><td>0</td><td>0</td><td>0</td><td>0</td><td>0</td><td>0</td><td>0</td><td>0</td><td>0</td><td>0</td><td>0</td><td>0</td><td>0</td><td>0</td><td>0</td><td>0</td><td>0</td><td>0</td><td>0</td><td>0</td><td>0</td><td>0</td><td>0</td><td>0</td><td>0</td><td>0</td><td>0</td><td>0</td><td>0</td><td>0</td><td>0</td> </tr> <tr> <td>Bit</td> <td>31</td><td>30</td><td>29</td><td>28</td><td>27</td><td>26</td><td>25</td><td>24</td><td>23</td><td>22</td><td>21</td><td>20</td><td>19</td><td>18</td><td>17</td><td>16</td><td>15</td><td>14</td><td>13</td><td>12</td><td>11</td><td>10</td><td>9</td><td>8</td><td>7</td><td>6</td><td>5</td><td>4</td><td>3</td><td>2</td><td>1</td><td>0</td> </tr> </table>		Reserved	Reserved	Reserved	Reserved	Reserved	Reserved	Reserved	Reserved	Reserved	Reserved	Reserved	Reserved	Reserved	Reserved	Reserved	Reserved	Reserved	Task Overrun	Gnd Warning	Reserved	PostFdbkLoss	AuxFdbkLoss	AltFdbkLoss	PrfFdbkLoss	Shear Pin 2	Shear Pin 1	Decel Inhib	OutPhaseLoss	InPhaseLoss	Load Loss	Motor OL	UnderVoltage	Power Loss	Default	0	0	0	0	0	0	0	0	0	0	0	0	0	0	0	0	0	0	0	0	0	0	0	0	0	0	0	0	0	0	0	0	0	Bit	31	30	29	28	27	26	25	24	23	22	21	20	19	18	17	16	15	14	13	12	11	10	9	8	7	6	5	4	3	2	1	0		0 = Condition False 1 = Condition True
	Reserved	Reserved	Reserved	Reserved	Reserved	Reserved	Reserved	Reserved	Reserved	Reserved	Reserved	Reserved	Reserved	Reserved	Reserved	Reserved	Reserved	Task Overrun	Gnd Warning	Reserved	PostFdbkLoss	AuxFdbkLoss	AltFdbkLoss	PrfFdbkLoss	Shear Pin 2	Shear Pin 1	Decel Inhib	OutPhaseLoss	InPhaseLoss	Load Loss	Motor OL	UnderVoltage	Power Loss																																																																										
Default	0	0	0	0	0	0	0	0	0	0	0	0	0	0	0	0	0	0	0	0	0	0	0	0	0	0	0	0	0	0	0	0	0																																																																										
Bit	31	30	29	28	27	26	25	24	23	22	21	20	19	18	17	16	15	14	13	12	11	10	9	8	7	6	5	4	3	2	1	0																																																																											

File	Group	No.	Display Name Full Name Description	Values	Read-Write	Data Type																																																																																																																												
DIAGNOSTICS	Fault/Alarm Info	960	<b>Alarm Status B</b> Alarm Status B Indicates the occurrence of conditions that have been configured as alarms.		RO	32-bit Integer																																																																																																																												
			Options	<table border="1"> <thead> <tr> <th>Reserved</th><th>Reserved</th><th>Reserved</th><th>Reserved</th><th>Reserved</th><th>Reserved</th><th>Reserved</th><th>Reserved</th><th>Reserved</th><th>Reserved</th><th>Reserved</th><th>Reserved</th><th>Reserved</th><th>Reserved</th><th>Reserved</th><th>Reserved</th><th>DB Res OT</th><th>N-1 Operate (1)</th><th>PumpOff Alarm (2)</th><th>OW Alarm TO (2)</th><th>OW Level (2)</th><th>Gnd Warning</th><th>Not Home Set(3)</th><th>Homing Actv</th><th>Profile Actv (3)</th><th>PWMFrg Reduc</th><th>CurLmt Reduc</th><th>Drive OL</th><th>StartOnPwrUp</th><th>Waking</th><th>Heatsink OT</th><th>IGBT OT</th> </tr> </thead> <tbody> <tr> <td>0</td><td>0</td><td>0</td><td>0</td><td>0</td><td>0</td><td>0</td><td>0</td><td>0</td><td>0</td><td>0</td><td>0</td><td>0</td><td>0</td><td>0</td><td>0</td><td>0</td><td>0</td><td>0</td><td>0</td><td>0</td><td>0</td><td>0</td><td>0</td><td>0</td><td>0</td><td>0</td><td>0</td><td>0</td><td>0</td><td>0</td><td>0</td> </tr> <tr> <td>Default</td><td>0</td><td>0</td><td>0</td><td>0</td><td>0</td><td>0</td><td>0</td><td>0</td><td>0</td><td>0</td><td>0</td><td>0</td><td>0</td><td>0</td><td>0</td><td>0</td><td>0</td><td>0</td><td>0</td><td>0</td><td>0</td><td>0</td><td>0</td><td>0</td><td>0</td><td>0</td><td>0</td><td>0</td><td>0</td><td>0</td><td>0</td> </tr> <tr> <td>Bit</td><td>31</td><td>30</td><td>29</td><td>28</td><td>27</td><td>26</td><td>25</td><td>24</td><td>23</td><td>22</td><td>21</td><td>20</td><td>19</td><td>18</td><td>17</td><td>16</td><td>15</td><td>14</td><td>13</td><td>12</td><td>11</td><td>10</td><td>9</td><td>8</td><td>7</td><td>6</td><td>5</td><td>4</td><td>3</td><td>2</td><td>1</td><td>0</td> </tr> </tbody> </table> <p>(1) 755 Frame 8 drives and larger only. <span style="float: right;">0 = Condition False</span>                  (2) 753 drives only. <span style="float: right;">1 = Condition True</span>                  (3) 755 drives only.</p> <p>Bit 0 "IGBT OT" – Indicates the transistor (IGBT) junction temperature reached the alarm level, which is 10 °C (50 °F) below the maximum (fault level) junction temperature.                  Bit 1 Heatsink OT" – Indicates the heatsink temperature reached the alarm level, which is 10 °C (50 °F) below the maximum (fault level) heatsink temperature.                  Bit 2 "Waking" – The Sleep /Wake function is in the Waking condition.                  Bit 3 "StartOnPwrUp" – The Start on powerup feature is active.                  Bit 4 "Drive OL" – Indicates overload condition has reached the alarm level and P940 [Drive OL Count] has reached 50%.                  Bit 5 "CurLmt Reduc" – Indicates the transistor (IGBT) junction temperature reached the level of current limit fold back, which is 5 °C (41 °F) below the maximum (fault level) junction temperature.                  Bit 6 "PWMFrg Reduc" – Indicates the transistor (IGBT) junction temperature reached the level of PWM frequency fold back, which is 10 °C (50 °F) below the maximum (fault level) junction temperature. Or the instantaneous rising of junction temperature exceeded 60 °C (140 °F).                  Bit 7 "Profile Actv" – Indicates the profile function is active, P1213 [Profile Command] Bit 12 "Prof Run Alarm" is set.                  Bit 8 "Homing Actv" – Indicates the homing function is active, P731 [Homing Control] Bit 5 "Homing Alarm" is set.                  Bit 9 "Not Home Set" – Indicates the profile function has executed without first executing the homing function, P1213 [Profile Command] Bit 11 "HomeNotSetAlarm" is set.                  Bit 10 "Gnd Warning" – The value set in P467 [Ground Warn Lvl] has been exceeded.                  Bit 11 "OW Level" – The value set in P1171 [TorqAlarm Level] has been reached.                  Bit 12 "OW Alarm TO" – The value set in P1172 [TorqAlm Timeout] has been reached.                  Bit 13 "PumpOff Alarm" – The pump off condition is active.                  Bit 14 "N-1 Operate" – Indicates the parallel drive is in operation mode.                  Bit 15 "DB Res OT" – Indicates the dynamic brake resistor has exceeded its maximum operating temperature.</p>	Reserved	Reserved	Reserved	Reserved	Reserved	Reserved	Reserved	Reserved	Reserved	Reserved	Reserved	Reserved	Reserved	Reserved	Reserved	Reserved	DB Res OT	N-1 Operate (1)	PumpOff Alarm (2)	OW Alarm TO (2)	OW Level (2)	Gnd Warning	Not Home Set(3)	Homing Actv	Profile Actv (3)	PWMFrg Reduc	CurLmt Reduc	Drive OL	StartOnPwrUp	Waking	Heatsink OT	IGBT OT	0	0	0	0	0	0	0	0	0	0	0	0	0	0	0	0	0	0	0	0	0	0	0	0	0	0	0	0	0	0	0	0	Default	0	0	0	0	0	0	0	0	0	0	0	0	0	0	0	0	0	0	0	0	0	0	0	0	0	0	0	0	0	0	0	Bit	31	30	29	28	27	26	25	24	23	22	21	20	19	18	17	16	15	14	13	12	11	10	9	8	7	6	5	4	3
Reserved	Reserved	Reserved	Reserved	Reserved	Reserved	Reserved	Reserved	Reserved	Reserved	Reserved	Reserved	Reserved	Reserved	Reserved	Reserved	DB Res OT	N-1 Operate (1)	PumpOff Alarm (2)	OW Alarm TO (2)	OW Level (2)	Gnd Warning	Not Home Set(3)	Homing Actv	Profile Actv (3)	PWMFrg Reduc	CurLmt Reduc	Drive OL	StartOnPwrUp	Waking	Heatsink OT	IGBT OT																																																																																																			
0	0	0	0	0	0	0	0	0	0	0	0	0	0	0	0	0	0	0	0	0	0	0	0	0	0	0	0	0	0	0	0																																																																																																			
Default	0	0	0	0	0	0	0	0	0	0	0	0	0	0	0	0	0	0	0	0	0	0	0	0	0	0	0	0	0	0	0																																																																																																			
Bit	31	30	29	28	27	26	25	24	23	22	21	20	19	18	17	16	15	14	13	12	11	10	9	8	7	6	5	4	3	2	1	0																																																																																																		





File Group	No.	Display Name Full Name Description	Values	Read-Write	Data Type																																																																																																		
DIAGNOSTICS Fault/Alarm Info	962	<p><b>AlarmA at Fault</b> Alarm A at Fault</p> <p>Captures and displays P959 [Alarm Status A] at the time of the last fault. For some alarms, the value captured in this parameter may not match peak/low at time of fault due to data latency. For details on alarms and faults, refer to <a href="#">Chapter 6</a>.</p> <table border="1"> <thead> <tr> <th>Options</th> <th>Reserved</th><th>Reserved</th><th>Reserved</th><th>Reserved</th><th>Reserved</th><th>Reserved</th><th>Reserved</th><th>Reserved</th><th>Reserved</th><th>Reserved</th><th>Reserved</th><th>Reserved</th><th>Reserved</th><th>Reserved</th><th>Reserved</th><th>Reserved</th><th>Task Overrun</th><th>Gnd Warning</th><th>Reserved</th><th>PosFdbkLoss</th><th>AuxFdbkLoss</th><th>AltFdbkLoss</th><th>PriFdbkLoss</th><th>Shear Pin 2</th><th>Shear Pin 1</th><th>Decel Inhib</th><th>OutPhaseLoss</th><th>InPhaseLoss</th><th>Load Loss</th><th>Motor OL</th><th>UnderVoltage</th><th>Power Loss</th> </tr> </thead> <tbody> <tr> <td>Default</td> <td>0</td><td>0</td><td>0</td><td>0</td><td>0</td><td>0</td><td>0</td><td>0</td><td>0</td><td>0</td><td>0</td><td>0</td><td>0</td><td>0</td><td>0</td><td>0</td><td>0</td><td>0</td><td>0</td><td>0</td><td>0</td><td>0</td><td>0</td><td>0</td><td>0</td><td>0</td><td>0</td><td>0</td><td>0</td><td>0</td><td>0</td><td>0</td> </tr> <tr> <td>Bit</td> <td>31</td><td>30</td><td>29</td><td>28</td><td>27</td><td>26</td><td>25</td><td>24</td><td>23</td><td>22</td><td>21</td><td>20</td><td>19</td><td>18</td><td>17</td><td>16</td><td>15</td><td>14</td><td>13</td><td>12</td><td>11</td><td>10</td><td>9</td><td>8</td><td>7</td><td>6</td><td>5</td><td>4</td><td>3</td><td>2</td><td>1</td><td>0</td> </tr> </tbody> </table> <p style="text-align: right;">0 = Condition False 1 = Condition True</p> <p>Bit 0 "Power Loss" – A Power Loss exception has been issued. Bit 1 "UnderVoltage" – An Under Voltage exception has been issued. Bit 2 "Motor OL" – An excessive motor load exists. Bit 4 "InPhaseLoss" – Input Phase Loss exception has been issued. Bit 5 "OutPhaseLoss" – Output Phase Loss exception has been issued. Bit 6 "Decel Inhib" – The drive is being Inhibited from decelerating to the commanded speed. Bit 7 "Shear Pin 1" – Value set in P436 [Shear Pin1 Level] has been exceeded. Bit 8 "Shear Pin 2" – Value set in P439 [Shear Pin2 Level] has been exceeded. Bit 9 "PriFdbkLoss" – When set, indicates that the device selected as the primary velocity feedback source has reported a device failure. P125 [Pri Vel Fdbk Sel] selects the device used as the primary velocity feedback source. The primary feedback device supplies motor speed feedback if the Automatic Tach Switchover option is either disabled or has not switched to the alternate feedback device. In order to report this condition as an alarm, the feedback loss configuration parameter for the primary feedback device must be configured for "Alarm." Bit 10 "AltFdbkLoss" – When set, indicates that the device selected as the alternate velocity feedback source has reported a device failure. P128 [Alt Vel Fdbk Sel] selects the device used as the alternate velocity feedback source. The alternate feedback device supplies motor speed feedback if the Automatic Tach Switchover option is enabled and the primary feedback device has failed. In order to report this condition as an alarm, the feedback loss configuration parameter for the alternate feedback device must be configured for "Alarm." Bit 11 "AuxFdbkLoss" – When set, indicates that the device selected as the auxiliary velocity feedback source has reported a device failure. P132 [Aux Vel Fdbk Sel] selects the device used as the auxiliary velocity feedback source. The auxiliary feedback device can be used to supply motor speed reference. In order to report this condition as an alarm, the feedback loss configuration parameter for the auxiliary feedback device must be configured for "Alarm." Bit 12 "PosFdbkLoss" – When set, indicates that the device selected as the position feedback source has reported a device failure. P135 [Psn Fdbk Sel] selects the device used as the position feedback source. Position feedback is used for position control applications. It can be the same device used for velocity feedback or position feedback can be supplied by a separate device. In order to report this condition as an alarm, the feedback loss configuration parameter for the position feedback device must be configured for "Alarm." Bit 14 "GndWarning" – Value set in P467 [Ground Warn Lvl] has been exceeded. Bit 15 "Task Overrun" – System resource utilization has been exceeded. See <a href="#">System Resource Allocation on page 318</a> for details.</p>	Options	Reserved	Reserved	Reserved	Reserved	Reserved	Reserved	Reserved	Reserved	Reserved	Reserved	Reserved	Reserved	Reserved	Reserved	Reserved	Reserved	Task Overrun	Gnd Warning	Reserved	PosFdbkLoss	AuxFdbkLoss	AltFdbkLoss	PriFdbkLoss	Shear Pin 2	Shear Pin 1	Decel Inhib	OutPhaseLoss	InPhaseLoss	Load Loss	Motor OL	UnderVoltage	Power Loss	Default	0	0	0	0	0	0	0	0	0	0	0	0	0	0	0	0	0	0	0	0	0	0	0	0	0	0	0	0	0	0	0	0	Bit	31	30	29	28	27	26	25	24	23	22	21	20	19	18	17	16	15	14	13	12	11	10	9	8	7	6	5	4	3	2	1	0	RO	32-bit Integer
	Options	Reserved	Reserved	Reserved	Reserved	Reserved	Reserved	Reserved	Reserved	Reserved	Reserved	Reserved	Reserved	Reserved	Reserved	Reserved	Reserved	Task Overrun	Gnd Warning	Reserved	PosFdbkLoss	AuxFdbkLoss	AltFdbkLoss	PriFdbkLoss	Shear Pin 2	Shear Pin 1	Decel Inhib	OutPhaseLoss	InPhaseLoss	Load Loss	Motor OL	UnderVoltage	Power Loss																																																																						
Default	0	0	0	0	0	0	0	0	0	0	0	0	0	0	0	0	0	0	0	0	0	0	0	0	0	0	0	0	0	0	0	0																																																																							
Bit	31	30	29	28	27	26	25	24	23	22	21	20	19	18	17	16	15	14	13	12	11	10	9	8	7	6	5	4	3	2	1	0																																																																							
963	<p><b>AlarmB at Fault</b> Alarm B at Fault</p> <p>Captures and displays P960 [Alarm Status B] at the time of the last fault. See parameter 960 [Alarm Status B] for bit descriptions. For some alarms, the value captured in this parameter may not match peak/low at time of fault due to data latency. For details on alarms and faults, refer to <a href="#">Chapter 6</a>.</p> <table border="1"> <thead> <tr> <th>Options</th> <th>Reserved</th><th>Reserved</th><th>Reserved</th><th>Reserved</th><th>Reserved</th><th>Reserved</th><th>Reserved</th><th>Reserved</th><th>Reserved</th><th>Reserved</th><th>Reserved</th><th>Reserved</th><th>Reserved</th><th>Reserved</th><th>Reserved</th><th>Reserved</th><th>DB Res OT</th><th>N-1 Operate</th><th>PumpOff Alarm</th><th>OW Alarm TO</th><th>OW Level</th><th>Gnd Warning</th><th>Not Home Set</th><th>Homing Actv</th><th>Profile Actv (1)</th><th>PWMFrdq Reduc</th><th>Curlmt Reduc</th><th>Drive OL</th><th>StartOnPwrUp</th><th>Waking</th><th>Heatsink OT</th><th>IGBT OT</th> </tr> </thead> <tbody> <tr> <td>Default</td> <td>0</td><td>0</td><td>0</td><td>0</td><td>0</td><td>0</td><td>0</td><td>0</td><td>0</td><td>0</td><td>0</td><td>0</td><td>0</td><td>0</td><td>0</td><td>0</td><td>0</td><td>0</td><td>0</td><td>0</td><td>0</td><td>0</td><td>0</td><td>0</td><td>0</td><td>0</td><td>0</td><td>0</td><td>0</td><td>0</td><td>0</td><td>0</td> </tr> <tr> <td>Bit</td> <td>31</td><td>30</td><td>29</td><td>28</td><td>27</td><td>26</td><td>25</td><td>24</td><td>23</td><td>22</td><td>21</td><td>20</td><td>19</td><td>18</td><td>17</td><td>16</td><td>15</td><td>14</td><td>13</td><td>12</td><td>11</td><td>10</td><td>9</td><td>8</td><td>7</td><td>6</td><td>5</td><td>4</td><td>3</td><td>2</td><td>1</td><td>0</td> </tr> </tbody> </table> <p>(1) 755 drives only.</p> <p style="text-align: right;">0 = Condition False 1 = Condition True</p>	Options	Reserved	Reserved	Reserved	Reserved	Reserved	Reserved	Reserved	Reserved	Reserved	Reserved	Reserved	Reserved	Reserved	Reserved	Reserved	Reserved	DB Res OT	N-1 Operate	PumpOff Alarm	OW Alarm TO	OW Level	Gnd Warning	Not Home Set	Homing Actv	Profile Actv (1)	PWMFrdq Reduc	Curlmt Reduc	Drive OL	StartOnPwrUp	Waking	Heatsink OT	IGBT OT	Default	0	0	0	0	0	0	0	0	0	0	0	0	0	0	0	0	0	0	0	0	0	0	0	0	0	0	0	0	0	0	0	0	Bit	31	30	29	28	27	26	25	24	23	22	21	20	19	18	17	16	15	14	13	12	11	10	9	8	7	6	5	4	3	2	1	0	RO	32-bit Integer	
Options	Reserved	Reserved	Reserved	Reserved	Reserved	Reserved	Reserved	Reserved	Reserved	Reserved	Reserved	Reserved	Reserved	Reserved	Reserved	Reserved	DB Res OT	N-1 Operate	PumpOff Alarm	OW Alarm TO	OW Level	Gnd Warning	Not Home Set	Homing Actv	Profile Actv (1)	PWMFrdq Reduc	Curlmt Reduc	Drive OL	StartOnPwrUp	Waking	Heatsink OT	IGBT OT																																																																							
Default	0	0	0	0	0	0	0	0	0	0	0	0	0	0	0	0	0	0	0	0	0	0	0	0	0	0	0	0	0	0	0	0																																																																							
Bit	31	30	29	28	27	26	25	24	23	22	21	20	19	18	17	16	15	14	13	12	11	10	9	8	7	6	5	4	3	2	1	0																																																																							

<b>DIAGNOSTICS</b>	<b>Fault/Alarm Info</b>	<b>964</b>	<b>753 CRC Flt Cfg</b>	Default: 6 - FltNonReset Options: 0 - Ignore 1 - Alarm 2 - Flt Minor 3 - FltCoastStop 4 - Flt RampStop 5 - Flt CL Stop 6 - FltNonReset	RW	32-bit Integer
		CRC Fault Configuration Allows the user to configure exception 917 [FPGA CRC Failure] and change the default state. Ignore (0) – No action is taken. Alarm (1) – Type 1 alarm indicated. Flt Minor (2) – Minor fault indicated. If running, drive continues to run. Enable with P950 [Minor Flt Cfg]. If not enabled, acts like a major fault. FltCoastStop (3) – Major fault indicated. Coast to Stop. Flt RampStop (4) – Major fault indicated. Ramp to Stop. Flt CL Stop (5) – Major fault indicated. Current Limit Stop. FltNonReset (6) – Major fault indicated. Cycle power to clear this fault.				

File	Group	No.	Display Name	Values	Read-Write	Data Type	
<b>DIAGNOSTICS</b>	<b>Testpoints</b>	970	<b>Testpoint Sel 1</b>	Default: 0	RW	32-bit Integer	
		974	<b>Testpoint Sel 2</b>	Min/Max: -2147483648 / 2147483647			
		978	<b>Testpoint Sel 3</b>				
		982	<b>Testpoint Sel 4</b>				
			Testpoint Select <i>n</i> Selects a source for the testpoint values ("Fval" and "Lval"). Used by the factory, typically for diagnostic purposes.				
			971	<b>Testpoint Fval 1</b>	Default: 0.000000	RW	Real
			975	<b>Testpoint Fval 2</b>	Min/Max: -/+ 220000000.000000		
			979	<b>Testpoint Fval 3</b>			
			983	<b>Testpoint Fval 4</b>			
			Testpoint Float Value <i>n</i> Displays data selected by [Testpoint Sel <i>n</i> ], if the data type is floating point.				
			972	<b>Testpoint Lval 1</b>	Default: 0	RW	32-bit Integer
			976	<b>Testpoint Lval 2</b>	Min/Max: -2147483648 / 2147483647		
		980	<b>Testpoint Lval 3</b>				
		984	<b>Testpoint Lval 4</b>				
		Testpoint Long Value <i>n</i> Displays data selected by [Testpoint Sel <i>n</i> ], if the data type is long integer.					








File	Group	No.	Display Name Full Name Description	Values		Read-Write	Data Type
				Default:	Min/Max:		
DIAGNOSTICS	Peak Detection	1035	<b>755 PkDtct Stpt Real</b> Peak Detection Setpoint Real A setpoint value, in the form of a real number. Intended to be used as a potential data source for P1038 [PkDtct1PresetSel] and P1043 [PkDtct2PresetSel].	Default: 0.000000 Min/Max: -/+ 220000000.000000		RW	Real
		1036	<b>755 PkDtct Stpt DInt</b> Peak Detection Setpoint D Integer A setpoint value, in the form of an integer number. Intended to be used as a potential data source for P1038 [PkDtct1PresetSel] and P1043 [PkDtct2PresetSel].	Default: 0 Min/Max: -2147483648 / 2147483647		RW	32-bit Integer
		1037	<b>755 PkDtct1 In Sel</b>  Peak Detection 1 Input Select Selects the input data source for the peak detect functions. The functions can be configured to sample and hold either the largest (maximum) or smallest (minimum) value of the input signal selected by this parameter. <b>Important:</b> Either real or integer data sources can be selected, but integer sources will be internally converted to real and displayed in the peak detect output as real numbers.	Default: 1035 Min/Max: 0 / 15999931		RW	32-bit Integer
		1038	<b>755 PkDtct1PresetSel</b> Peak Detection 1 Preset Select Selects the preset data source for the peak detect functions. The output of the each peak detect function can be forced to equal the value of the input signal selected by this parameter by using the "Peak1 Set" bit in P1039 [Peak1 Cfg]. The same integer to real number conversion applies to both the input and the preset signal.	Default: 0 Min/Max: 0 / 15999931		RW	32-bit Integer

File	Group	No.	Display Name Full Name Description	Values	Read-Write	Data Type																																																						
DIAGNOSTICS	Peak Detection	1039	<b>755 Peak1 Cfg</b> Peak 1 Configure Configures operation of each peak detector. Options <table border="1"> <tr> <td>Reserved</td><td>Reserved</td><td>Reserved</td><td>Reserved</td><td>Reserved</td><td>Reserved</td><td>Reserved</td><td>Reserved</td><td>Reserved</td><td>Reserved</td><td>Reserved</td><td>Reserved</td><td>Reserved</td><td>Reserved</td><td>Reserved</td><td>Peak1 Set</td><td>Peak1 Hold</td><td>Peak1 Peak</td> </tr> <tr> <td>0</td><td>0</td><td>0</td><td>0</td><td>0</td><td>0</td><td>0</td><td>0</td><td>0</td><td>0</td><td>0</td><td>0</td><td>0</td><td>0</td><td>0</td><td>0</td><td>0</td><td>0</td> </tr> <tr> <td>15</td><td>14</td><td>13</td><td>12</td><td>11</td><td>10</td><td>9</td><td>8</td><td>7</td><td>6</td><td>5</td><td>4</td><td>3</td><td>2</td><td>1</td><td>0</td><td></td><td></td> </tr> </table> Bit 0 "Peak1 Peak" – 0 = Capture minimum value of the input signal. 1 = Capture maximum value of the input signal. Bit 1 "Peak1 Hold" – 0 = Monitor input. 1 = Ignore input and hold output at present value. This bit is overridden by Bit 2. Bit 2 "Peak1 Set" – 0 = Resume normal capture of the input signal value (assuming Bit 1 is also = 0). The preset signal will be used as a starting value to compare against further changes in the input signal level. 1 = Force output of the peak detect function to equal the signal selected by [PKDtctnPresetSel].	Reserved	Reserved	Reserved	Reserved	Reserved	Reserved	Reserved	Reserved	Reserved	Reserved	Reserved	Reserved	Reserved	Reserved	Reserved	Peak1 Set	Peak1 Hold	Peak1 Peak	0	0	0	0	0	0	0	0	0	0	0	0	0	0	0	0	0	0	15	14	13	12	11	10	9	8	7	6	5	4	3	2	1	0				RW	16-bit Integer
		Reserved	Reserved	Reserved	Reserved	Reserved	Reserved	Reserved	Reserved	Reserved	Reserved	Reserved	Reserved	Reserved	Reserved	Reserved	Peak1 Set	Peak1 Hold	Peak1 Peak																																									
		0	0	0	0	0	0	0	0	0	0	0	0	0	0	0	0	0	0																																									
		15	14	13	12	11	10	9	8	7	6	5	4	3	2	1	0																																											
		1040	<b>755 Peak 1 Change</b> Peak 1 Change Status of the peak detectors. Options <table border="1"> <tr> <td>Reserved</td><td>Reserved</td><td>Reserved</td><td>Reserved</td><td>Reserved</td><td>Reserved</td><td>Reserved</td><td>Reserved</td><td>Reserved</td><td>Reserved</td><td>Reserved</td><td>Reserved</td><td>Reserved</td><td>Reserved</td><td>Reserved</td><td>Reserved</td><td>Reserved</td><td>Peak1Change</td> </tr> <tr> <td>0</td><td>0</td><td>0</td><td>0</td><td>0</td><td>0</td><td>0</td><td>0</td><td>0</td><td>0</td><td>0</td><td>0</td><td>0</td><td>0</td><td>0</td><td>0</td><td>0</td><td>0</td> </tr> <tr> <td>15</td><td>14</td><td>13</td><td>12</td><td>11</td><td>10</td><td>9</td><td>8</td><td>7</td><td>6</td><td>5</td><td>4</td><td>3</td><td>2</td><td>1</td><td>0</td><td></td><td></td> </tr> </table> 0 = Output value is held or set. 1 = Output value has changed.	Reserved	Reserved	Reserved	Reserved	Reserved	Reserved	Reserved	Reserved	Reserved	Reserved	Reserved	Reserved	Reserved	Reserved	Reserved	Reserved	Reserved	Peak1Change	0	0	0	0	0	0	0	0	0	0	0	0	0	0	0	0	0	0	15	14	13	12	11	10	9	8	7	6	5	4	3	2	1	0				RO	16-bit Integer
Reserved	Reserved	Reserved	Reserved	Reserved	Reserved	Reserved	Reserved	Reserved	Reserved	Reserved	Reserved	Reserved	Reserved	Reserved	Reserved	Reserved	Peak1Change																																											
0	0	0	0	0	0	0	0	0	0	0	0	0	0	0	0	0	0																																											
15	14	13	12	11	10	9	8	7	6	5	4	3	2	1	0																																													
1041	<b>755 PeakDetect1 Out</b> Peak Detection 1 Output Displays the output of the peak detector, according to the operation selected by the configuration bits, and is always displayed as a real number, regardless of the selected signal type.	Default: 0.000000 Min/Max: -/+2147483648.000000	RO	Real																																																								
1042	 <b>755 PkDtct2 In Sel</b> Peak Detection 2 Input Select Selects the input data source for the peak detect functions. The functions can be configured to sample and hold either the largest (maximum) or smallest (minimum) value of the input signal selected by this parameter. <b>Important:</b> Either real or integer data sources can be selected, but integer sources will be internally converted to real and displayed in the peak detect output as real numbers.	Default: 1035 Min/Max: 0 / 159999	RW	32-bit Integer																																																								
1043	<b>755 PkDtct2PresetSel</b> Peak Detection 2 Preset Select Selects the preset data source for the peak detect functions. The output of the each peak detect function can be forced to equal the value of the input signal selected by this parameter by using the "Peak2 Set" bit in P1044 [Peak2 Cfg]. The same integer to real number conversion applies to both the input and the preset signal.	Default: 0 Min/Max: 0 / 159999	RW	32-bit Integer																																																								

File	Group	No.	Display Name Full Name Description	Values	Read-Write	Data Type																																																						
DIAGNOSTICS	Peak Detection	1044	<b>755 Peak2 Cfg</b> Peak 2 Configure Configures operation of each peak detector. Options <table border="1"> <tr> <td>Reserved</td><td>Reserved</td><td>Reserved</td><td>Reserved</td><td>Reserved</td><td>Reserved</td><td>Reserved</td><td>Reserved</td><td>Reserved</td><td>Reserved</td><td>Reserved</td><td>Reserved</td><td>Reserved</td><td>Reserved</td><td>Reserved</td><td>Peak2 Set</td><td>Peak2 Hold</td><td>Peak2 Peak</td> </tr> <tr> <td>0</td><td>0</td><td>0</td><td>0</td><td>0</td><td>0</td><td>0</td><td>0</td><td>0</td><td>0</td><td>0</td><td>0</td><td>0</td><td>0</td><td>0</td><td>0</td><td>0</td><td>0</td> </tr> <tr> <td>15</td><td>14</td><td>13</td><td>12</td><td>11</td><td>10</td><td>9</td><td>8</td><td>7</td><td>6</td><td>5</td><td>4</td><td>3</td><td>2</td><td>1</td><td>0</td><td></td><td></td> </tr> </table> <p>Bit 0 "Peak2 Peak" – 0 = Capture minimum value of the input signal. 1 = Capture maximum value of the input signal.                      Bit 1 "Peak2 Hold" – 0 = Monitor input. 1 = Ignore input and hold output at present value. This bit is overridden by Bit 2.                      Bit 2 "Peak2 Set" – 0 = Resume normal capture of the input signal value (assuming Bit 1 is also = 0). The preset signal will be used as a starting value to compare against further changes in the input signal level. 1 = Force output of the peak detect function to equal the signal selected by [PkDtctnPresetSel].</p>	Reserved	Reserved	Reserved	Reserved	Reserved	Reserved	Reserved	Reserved	Reserved	Reserved	Reserved	Reserved	Reserved	Reserved	Reserved	Peak2 Set	Peak2 Hold	Peak2 Peak	0	0	0	0	0	0	0	0	0	0	0	0	0	0	0	0	0	0	15	14	13	12	11	10	9	8	7	6	5	4	3	2	1	0				RW	16-bit Integer
		Reserved	Reserved	Reserved	Reserved	Reserved	Reserved	Reserved	Reserved	Reserved	Reserved	Reserved	Reserved	Reserved	Reserved	Reserved	Peak2 Set	Peak2 Hold	Peak2 Peak																																									
		0	0	0	0	0	0	0	0	0	0	0	0	0	0	0	0	0	0																																									
15	14	13	12	11	10	9	8	7	6	5	4	3	2	1	0																																													
1045	<b>755 Peak 2 Change</b> Peak 2 Change Status of the peak detectors. Options <table border="1"> <tr> <td>Reserved</td><td>Reserved</td><td>Reserved</td><td>Reserved</td><td>Reserved</td><td>Reserved</td><td>Reserved</td><td>Reserved</td><td>Reserved</td><td>Reserved</td><td>Reserved</td><td>Reserved</td><td>Reserved</td><td>Reserved</td><td>Reserved</td><td>Reserved</td><td>Reserved</td><td>Peak2Change</td> </tr> <tr> <td>0</td><td>0</td><td>0</td><td>0</td><td>0</td><td>0</td><td>0</td><td>0</td><td>0</td><td>0</td><td>0</td><td>0</td><td>0</td><td>0</td><td>0</td><td>0</td><td>0</td><td>0</td> </tr> <tr> <td>15</td><td>14</td><td>13</td><td>12</td><td>11</td><td>10</td><td>9</td><td>8</td><td>7</td><td>6</td><td>5</td><td>4</td><td>3</td><td>2</td><td>1</td><td>0</td><td></td><td></td> </tr> </table> <p>0 = Output value is held or set.                      1 = Output value has changed.</p>	Reserved	Reserved	Reserved	Reserved	Reserved	Reserved	Reserved	Reserved	Reserved	Reserved	Reserved	Reserved	Reserved	Reserved	Reserved	Reserved	Reserved	Peak2Change	0	0	0	0	0	0	0	0	0	0	0	0	0	0	0	0	0	0	15	14	13	12	11	10	9	8	7	6	5	4	3	2	1	0				RO	16-bit Integer		
Reserved	Reserved	Reserved	Reserved	Reserved	Reserved	Reserved	Reserved	Reserved	Reserved	Reserved	Reserved	Reserved	Reserved	Reserved	Reserved	Reserved	Peak2Change																																											
0	0	0	0	0	0	0	0	0	0	0	0	0	0	0	0	0	0																																											
15	14	13	12	11	10	9	8	7	6	5	4	3	2	1	0																																													
1046	<b>755 PeakDetect2 Out</b> Peak Detection 2 Output Displays the output of the peak detector, according to the operation selected by the configuration bits, and is always displayed as a real number, regardless of the selected signal type.	Default: 0.000000 Min/Max: -/+2147483648.000000	RO	Real																																																								

# Drive (Port 0) Applications File

File	Group	No.	Display Name Full Name Description	Values	Read-Write	Data Type																																																			
APPLICATIONS	Process PID	1065	<b>PID Cfg</b>  PID Configuration Main configuration of the Process PID controller. Options	<table border="1"> <thead> <tr> <th></th> <th>Reserved</th> <th>Reserved</th> <th>Reserved</th> <th>Reserved</th> <th>Reserved</th> <th>Reserved</th> <th>Reserved</th> <th>Reserved</th> <th>Reserved</th> <th>Percent Ref</th> <th>Anti Windup</th> <th>Stop Mode</th> <th>Fdbk Sqrt</th> <th>Zero Clamp</th> <th>Ramp Ref</th> <th>Preload Int</th> </tr> </thead> <tbody> <tr> <td>Default</td> <td>0</td> <td>0</td> <td>0</td> <td>0</td> <td>0</td> <td>0</td> <td>0</td> <td>0</td> <td>0</td> <td>0</td> <td>0</td> <td>0</td> <td>0</td> <td>0</td> <td>0</td> <td>0</td> </tr> <tr> <td>Bit</td> <td>15</td> <td>14</td> <td>13</td> <td>12</td> <td>11</td> <td>10</td> <td>9</td> <td>8</td> <td>7</td> <td>6</td> <td>5</td> <td>4</td> <td>3</td> <td>2</td> <td>1</td> <td>0</td> </tr> </tbody> </table> <p>0 = Disabled 1 = Enabled</p> <p>Bit 0 "Preload Int" – Preload the PID integral term with PID Preload value.                      Bit 1 "Ramp Ref" – Ramp PID Reference when first enabled.                      Bit 2 "Zero Clamp" – Clamp PID output to zero when P1079 [PID Output Sel] is set to option 2 "Speed Trim" or 4 "Torque Trim."                      Bit 3 "Fdbk Sqrt" – Apply Square root function to the Feedback signal.                      Bit 4 "Stop Mode" – When P1079 [PID Output Sel] is set to option 2 "Speed Trim," PID remains active during stopping maneuver.                      Bit 5 "Anti Windup" – Prevents PID integrator from getting too far ahead of frequency ramp.                      Bit 6 "Percent Ref" – When P1079 [PID Output Sel] is set to option 2 "Speed Trim," PID output is a percentage of the Speed Reference versus a percentage of P27 [Motor NP Hertz].</p>		Reserved	Reserved	Reserved	Reserved	Reserved	Reserved	Reserved	Reserved	Reserved	Percent Ref	Anti Windup	Stop Mode	Fdbk Sqrt	Zero Clamp	Ramp Ref	Preload Int	Default	0	0	0	0	0	0	0	0	0	0	0	0	0	0	0	0	Bit	15	14	13	12	11	10	9	8	7	6	5	4	3	2	1	0	RW	16-bit Integer
			Reserved	Reserved	Reserved	Reserved	Reserved	Reserved	Reserved	Reserved	Reserved	Percent Ref	Anti Windup	Stop Mode	Fdbk Sqrt	Zero Clamp	Ramp Ref	Preload Int																																							
		Default	0	0	0	0	0	0	0	0	0	0	0	0	0	0	0	0																																							
Bit	15	14	13	12	11	10	9	8	7	6	5	4	3	2	1	0																																									
1066	<b>PID Control</b> PID Control Used for dynamically controlling the Process PID controller. Options	<table border="1"> <thead> <tr> <th></th> <th>Reserved</th> <th>Reserved</th> <th>Reserved</th> <th>Reserved</th> <th>Reserved</th> <th>Reserved</th> <th>Reserved</th> <th>Reserved</th> <th>Reserved</th> <th>Reserved</th> <th>Reserved</th> <th>PID InvError</th> <th>PID Reset</th> <th>PID Hold</th> <th>PID Enable</th> </tr> </thead> <tbody> <tr> <td>Default</td> <td>0</td> <td>0</td> <td>0</td> <td>0</td> <td>0</td> <td>0</td> <td>0</td> <td>0</td> <td>0</td> <td>0</td> <td>0</td> <td>0</td> <td>0</td> <td>0</td> <td>0</td> </tr> <tr> <td>Bit</td> <td>15</td> <td>14</td> <td>13</td> <td>12</td> <td>11</td> <td>10</td> <td>9</td> <td>8</td> <td>7</td> <td>6</td> <td>5</td> <td>4</td> <td>3</td> <td>2</td> <td>1</td> <td>0</td> </tr> </tbody> </table> <p>0 = Condition False 1 = Condition True</p> <p>Bit 0 "PID Enable" – PID controller is enabled.                      Bit 1 "PID Hold" – Hold PID integrator.                      Bit 2 "PID Reset" – Reset PID integrator.                      Bit 3 "PID InvError" – Invert PID error.</p>		Reserved	Reserved	Reserved	Reserved	Reserved	Reserved	Reserved	Reserved	Reserved	Reserved	Reserved	PID InvError	PID Reset	PID Hold	PID Enable	Default	0	0	0	0	0	0	0	0	0	0	0	0	0	0	0	Bit	15	14	13	12	11	10	9	8	7	6	5	4	3	2	1	0	RW	16-bit Integer				
	Reserved	Reserved	Reserved	Reserved	Reserved	Reserved	Reserved	Reserved	Reserved	Reserved	Reserved	PID InvError	PID Reset	PID Hold	PID Enable																																										
Default	0	0	0	0	0	0	0	0	0	0	0	0	0	0	0																																										
Bit	15	14	13	12	11	10	9	8	7	6	5	4	3	2	1	0																																									
1067	<b>PID Ref Sel</b>  PID Reference Select  Selects the source for the PID reference.	Default: 1070 Min/Max: 1 / 159999	RW	32-bit Integer																																																					



File	Group	No.	Display Name Full Name Description	Values	Read-Write	Data Type
		1068	<b>PID Ref AnlgHi</b> PID Reference Analog High When an analog input is selected for the PID reference this parameter sets the high value of scaling. For example, if referencing a 0-10 V value which represents an engineering unit such as base motor speed or PSI, then this value equals 100%, the high value, of the referenced value.	Units: % Default: 100.00 Min/Max: -/+100.00	RW	Real
		1069	<b>PID Ref AnlgLo</b> PID Reference Analog Low When an analog input is selected for PID reference this sets the low value of scaling. For example, if referencing a 0-10 V value which represents an engineering unit such as base motor speed or PSI, then this value equals 0%, the low value, of the referenced value.	Units: % Default: 0.00 Min/Max: -/+100.00	RW	Real
		1070	<b>PID Setpoint</b> PID Setpoint Provides an internal fixed value for PID reference when P1067 [PID Ref Sel] is set to this parameter. A value of 100% is equal to the highest referenced value.	Units: % Default: 0.00 Min/Max: -/+100.00	RW	Real
		1071	<b>PID Ref Mult</b> PID Reference Multiplier Sets the multiplying factor which is applied to the Reference source before the Reference is used. A value of 100% is equal to the lowest referenced value.	Units: % Default: 100.00 Min/Max: -/+100.00	RW	Real
APPLICATIONS	Process PID	1072	 <b>PID Fdbk Sel</b> PID Feedback Select Selects the source for the PID Feedback.	Default: 1077 Min/Max: 1 / 159999	RW	32-bit Integer
		1073	<b>PID Fdbk AnlgHi</b> PID Feedback Analog High When an analog input is selected for PID Feedback this sets high value of scaling. A value of 100% is equal to the highest level of the referenced value.	Units: % Default: 100.00 Min/Max: -/+100.00	RW	Real
		1074	<b>PID Fdbk AnlgLo</b> PID Feedback Analog Low When an analog input is selected for PID Feedback this sets low value of scaling. A value of 100% is equal to the lowest level of the referenced value.	Units: % Default: 0.00 Min/Max: -/+100.00	RW	Real
		1075	 <b>PID FBLoss SpSel</b> PID Feedback Loss Speed Select  When an analog input is selected for PID Feedback, P1079 [PID Output Sel] is set to Speed Excl/Speed Trim, and an analog signal loss is detected, sets speed to this source. Analog signal loss occurs when the signal falls below 2V (0...10V signal) or below 4 mA (4...20 mA signal).	Default: 546 Min/Max: 0 / 159999	RW	32-bit Integer
		1076	 <b>PID FBLoss TqSel</b> PID Feedback Loss Torque Select  When an analog input is selected for PID Feedback, P1079 [PID Output Sel] is set to option 1 "Speed Excl," 2 "Speed Trim," 3 "Torque Excl," or 4 "Torque Trim" and an analog signal loss is detected, sets torque to this source.	Default: 676 Min/Max: 0 / 159999	RW	32-bit Integer
		1077	<b>PID Fdbk</b> PID Feedback Provides an internal fixed value for PID Feedback when P1072 [PID Fdbk Sel] is set to this parameter. A value of 100% is equal to motor base speed.	Units: % Default: 0.00 Min/Max: -/+100.00	RW	Real
		1078	<b>PID Fdbk Mult</b> PID Feedback Multiplier Sets the multiplying factor which is applied to the Feedback source before the Feedback is used.	Units: % Default: 100.00 Min/Max: -/+100.00	RW	Real


File	Group	No.	Display Name Full Name Description	Values	Read-Write	Data Type
APPLICATIONS	Process PID	1079	<b>PID Output Sel</b> PID Output Select Selects the target for the PID Output. “Not Used” (0) – PID output is not applied to any speed reference. “Speed Excl” (1) – PID output is only reference applied to speed reference. “Speed Trim” (2) – PID output is applied to speed reference as a trim value. “Torque Excl” (3) – PID output is only reference applied to torque reference. “Torque Trim” (4) – PID output is applied to torque reference as a trim value. “Volt Excl” (5) – PID output is only reference applied to voltage reference. “Volt Trim” (6) – PID output is applied to voltage reference as a trim value.	Default: 2 = “Speed Trim” Options: 0 = “Not Used” 1 = “Speed Excl” 2 = “Speed Trim” 3 = “Torque Excl” 4 = “Torque Trim” 5 = “Volt Excl” 6 = “Volt Trim”	RW	32-bit Integer
		1080	<b>PID Output Mult</b> PID Output Multiplier Sets the multiplying factor which is applied to the PID Output before the PID Output is used. A value of 100% is equal to motor base speed.	Units: % Default: 100.00000 Min/Max: -/+100.00000	RW	Real
		1081	<b>PID Upper Limit</b> PID Upper Limit Sets the upper limit for the P1093 [PID Output Meter]. A value of 100% is equal to motor base speed.	Units: % Default: 100.00 Min/Max: -/+800.00	RW	Real
		1082	<b>PID Lower Limit</b> PID Lower Limit Sets the lower limit for the P1093 [PID Output Meter]. A value of 100% is equal to motor base speed.	Units: % Default: -100.00 Min/Max: -/+800.00	RW	Real
		1083	<b>PID Deadband</b> PID Deadband Determines the error (+/-) which will be ignored. Any error which falls within this band will not change the PID output. A value of 100% is equal to motor base speed.	Units: % Default: 0.00 Min/Max: 0.00 / 100.00	RW	Real
		1084	<b>PID LP Filter BW</b> PID Low Pass Filter Bandwidth Sets the level of filtering applied to the error signal. Zero will disable this filter.	Units: R/S Default: 0.00 Min/Max: 0.00 / 100.00	RW	Real
		1085	<b>PID Preload</b> PID Preload Sets the value used to preload PID Integrator when PID is enabled and P1065 [PID Cfg] Bit 0 “Preload Int” is set to 1. A value of 100% is equal to motor base speed.	Units: % Default: 0.00 Min/Max: -/+100.00	RW	Real
		1086	<b>PID Prop Gain</b> PID Proportional Gain Sets the value for the PID proportional component. PID ErrorMeter x PID Prop Gain = PID Output	Default: 1.00 Min/Max: 0.00 / 100.00	RW	Real
		1087	<b>PID Int Time</b> PID Integral Time Time required for the integral component to reach 100% of P1092 [PID Error Meter]. Not used when P1066 [PID Control] Bit 1 “PID Hold” = 1 (enabled).	Units: Secs Default: 1.00 Min/Max: 0.00 / 100.00	RW	Real
		1088	<b>PID Deriv Time</b> PID Derivative Time Refer to formula below: $PID_{Out} = KD \text{ (Sec)} \times \frac{d_{PI \text{ Error}} \text{ (%)}}{d_t \text{ (Sec)}}$ KD = P1088 $d_{PI \text{ Error}} = \text{Error} - \text{Last Error}$ $d_t = \text{Interrupt Time}$ A setting of zero disables this parameter.	Units: Secs Default: 0.00 Min/Max: 0.00 / 100.00	RW	Real

File	Group	No.	Display Name Full Name Description	Values	Read-Write	Data Type																																																						
<b>APPLICATIONS</b>	<b>Process PID</b>	<b>1089</b>	<b>PID Status</b> PID Status Status of the Process PI regulator.  Options	<table border="1" style="width: 100%; border-collapse: collapse; text-align: center;"> <tr> <td></td> <td>Reserved</td><td>Reserved</td><td>Reserved</td><td>Reserved</td><td>Reserved</td><td>Reserved</td><td>Reserved</td><td>Reserved</td><td>Reserved</td><td>Reserved</td><td>Reserved</td><td>Reserved</td><td>Reserved</td><td>PID In Limit</td><td>PID Reset</td><td>PID Hold</td><td>PID Enabled</td> </tr> <tr> <td>Default</td> <td>0</td><td>0</td><td>0</td><td>0</td><td>0</td><td>0</td><td>0</td><td>0</td><td>0</td><td>0</td><td>0</td><td>0</td><td>0</td><td>0</td><td>0</td><td>0</td><td>0</td> </tr> <tr> <td>Bit</td> <td>15</td><td>14</td><td>13</td><td>12</td><td>11</td><td>10</td><td>9</td><td>8</td><td>7</td><td>6</td><td>5</td><td>4</td><td>3</td><td>2</td><td>1</td><td>0</td><td></td> </tr> </table>		Reserved	Reserved	Reserved	Reserved	Reserved	Reserved	Reserved	Reserved	Reserved	Reserved	Reserved	Reserved	Reserved	PID In Limit	PID Reset	PID Hold	PID Enabled	Default	0	0	0	0	0	0	0	0	0	0	0	0	0	0	0	0	0	Bit	15	14	13	12	11	10	9	8	7	6	5	4	3	2	1	0			16-bit Integer
			Reserved	Reserved	Reserved	Reserved	Reserved	Reserved	Reserved	Reserved	Reserved	Reserved	Reserved	Reserved	Reserved	PID In Limit	PID Reset	PID Hold	PID Enabled																																									
		Default	0	0	0	0	0	0	0	0	0	0	0	0	0	0	0	0	0																																									
		Bit	15	14	13	12	11	10	9	8	7	6	5	4	3	2	1	0																																										
					0 = Condition False 1 = Condition True																																																							
			Bit 0 "PID Enable" – PID controller is enabled. Bit 1 "PID Hold" – Hold PID integrator. Bit 2 "PID Reset" – Reset PID integrator. Bit 3 "PID In Limit" – PID in limit.																																																									
		<b>1090</b>	<b>PID Ref Meter</b> PID Reference Meter Present value of the PI reference signal. A value of 100% is equal to motor base speed.	Units: % Default: 0.00 Min/Max: -/+100.00	RO	Real																																																						
		<b>1091</b>	<b>PID Fdbk Meter</b> PID Feedback Meter Present value of the PI feedback signal. A value of 100% is equal to motor base speed.	Units: % Default: 0.00 Min/Max: -/+100.00	RO	Real																																																						
		<b>1092</b>	<b>PID Error Meter</b> PID Error Meter Present value of the PI error. A value of 100% is equal to motor base speed.	Units: % Default: 0.00 Min/Max: -/+200.00	RO	Real																																																						
		<b>1093</b>	<b>PID Output Meter</b> PID Output Meter Present value of the PI output. A value of 100% is equal to motor base speed.	Units: % Default: 0.00 Min/Max: -/+800.00	RO	Real																																																						



File	Group	No.	Display Name Full Name Description	Values	Read-Write	Data Type																																																		
APPLICATIONS	Torque Prove	1100	<div style="background-color: #808080; color: white; padding: 2px; display: inline-block; margin-bottom: 5px;">755</div> <b>Trq Prove Cfg</b> Torque Prove Configure Enables/disables torque/brake proving function. When “Enabled” brake control comes from a digital output relay that is set to select Port 0, P1103 [Trq Prove Status] Bit 4 “Brake Set.” See PowerFlex 755 Lifting/Torque Proving on page 456 and, PowerFlex 750-Series AC Drives Reference Manual, publication <a href="#">750-RM002</a> , for examples on how to use Torque Prove with PowerFlex 755 drives.  Options <table border="1" style="font-size: small; border-collapse: collapse; width: 100%;"> <thead> <tr> <th></th> <th>Reserved</th> <th>Reserved</th> <th>Reserved</th> <th>Reserved</th> <th>Reserved</th> <th>BrkSlpFltCfg</th> <th>BkSlp SpdlLmt</th> <th>Fast Stop Bk</th> <th>Test Brake</th> <th>BrkSlpStart</th> <th>BrkSlpEnds</th> <th>FW LoadLimit</th> <th>Preload</th> <th>Micro Psn</th> <th>Encoderless</th> <th>TP Enable</th> </tr> </thead> <tbody> <tr> <td>Default</td> <td>0</td> <td>0</td> <td>0</td> <td>0</td> <td>0</td> <td>0</td> <td>0</td> <td>0</td> <td>0</td> <td>0</td> <td>0</td> <td>0</td> <td>0</td> <td>0</td> <td>0</td> <td>0</td> </tr> <tr> <td>Bit</td> <td>15</td> <td>14</td> <td>13</td> <td>12</td> <td>11</td> <td>10</td> <td>9</td> <td>8</td> <td>7</td> <td>6</td> <td>5</td> <td>4</td> <td>3</td> <td>2</td> <td>1</td> <td>0</td> </tr> </tbody> </table> 0 = Disabled 1 = Enabled  Bit 0 “TP Enable” – Enables TorqProve functions. Bit 1 “Encoderless” – Enables encoderless operation – Bit 0 must also be enabled. Read the Attention statement under Lifting/Torque Proving on <a href="#">page 372</a> . Bit 2 “Micro Psn” – Enables the Micro Position digital input to change the speed command by the value set in P1112 [MicroPsnScalePct] while the drive is running. Bit 3 “Preload” – “0” uses the last torque for preload. “1” uses P676 [Trq Ref A Stpt] if commanded direction is forward and P681 [Trq Ref B Stpt] for reverse. Bit 4 “FW LoadLimit” – Enables drive to perform load calculation at base speed. Drive will then limit operation above base speed depending on load. “FWLoadLimit” = “Field Weakening Load Limit” Bit 5 “BrkSlpEnds” – A “1” Disables the partial Brake Slip routine from the drive when encoderless is selected. Bit 6 “BrkSlpStart” – Starts drive if Brake slippage is detected. Drive does not start if P933 [Start Inhibits] exists. Bit 7 “Test Brake” – Tests the brake at Start. Torque is applied against the brake while movement is monitored. Bit 8 “Fast Stop Bk” – Brake is set immediately upon receiving a Fast Stop input vs. setting the brake after the ramp. Bit 9 “BkSlp SpdlLmt” – When a brake slip condition is detected, the load is lowered at a fixed speed (Preset Speed 1). Bit 10 “BrkSlpFltCfg” – When set, the brake slip fault does not occur if the Enable input or Safety Enable input is low. When cleared, the brake slip fault occurs regardless of the state of the Enable input or Safety Enable input. This is the behavior of the existing function.		Reserved	Reserved	Reserved	Reserved	Reserved	BrkSlpFltCfg	BkSlp SpdlLmt	Fast Stop Bk	Test Brake	BrkSlpStart	BrkSlpEnds	FW LoadLimit	Preload	Micro Psn	Encoderless	TP Enable	Default	0	0	0	0	0	0	0	0	0	0	0	0	0	0	0	0	Bit	15	14	13	12	11	10	9	8	7	6	5	4	3	2	1	0	RW	16-bit Integer
			Reserved	Reserved	Reserved	Reserved	Reserved	BrkSlpFltCfg	BkSlp SpdlLmt	Fast Stop Bk	Test Brake	BrkSlpStart	BrkSlpEnds	FW LoadLimit	Preload	Micro Psn	Encoderless	TP Enable																																						
Default	0	0	0	0	0	0	0	0	0	0	0	0	0	0	0	0																																								
Bit	15	14	13	12	11	10	9	8	7	6	5	4	3	2	1	0																																								
1101	<div style="background-color: #808080; color: white; padding: 2px; display: inline-block; margin-bottom: 5px;">755</div> <b>Trq Prove Setup</b> Torque Prove Setup Allows control of specific torque proving functions through a communication device.  Options <table border="1" style="font-size: small; border-collapse: collapse; width: 100%;"> <thead> <tr> <th></th> <th>Reserved</th> <th>Reserved</th> <th>Reserved</th> <th>Reserved</th> <th>Reserved</th> <th>Reserved</th> <th>Reserved</th> <th>Reserved</th> <th>NHdwrOvrTrvl</th> <th>PHdwrOvrTrvl</th> <th>End Stop Rev</th> <th>Decel Rev</th> <th>End Stop Fwd</th> <th>Decel Fwd</th> <th>Float Micro</th> <th>Fast Stop</th> </tr> </thead> <tbody> <tr> <td>Default</td> <td>0</td> <td>0</td> <td>0</td> <td>0</td> <td>0</td> <td>0</td> <td>0</td> <td>0</td> <td>0</td> <td>0</td> <td>0</td> <td>0</td> <td>0</td> <td>0</td> <td>0</td> <td>0</td> </tr> <tr> <td>Bit</td> <td>15</td> <td>14</td> <td>13</td> <td>12</td> <td>11</td> <td>10</td> <td>9</td> <td>8</td> <td>7</td> <td>6</td> <td>5</td> <td>4</td> <td>3</td> <td>2</td> <td>1</td> <td>0</td> </tr> </tbody> </table> 0 = Disabled 1 = Enabled  Bit 0 “Fast Stop” – Forces a current limit stop. Bit 1 “Float Micro” – Activates the micro position function when selected and running. Activates float when stopping. Bit 2 “Decel Fwd” – Forces decel forward travel limit. Bit 3 “End Stop Fwd” – Forces end forward travel limit. Bit 4 “Decel Rev” – Forces decel reverse travel limit. Bit 5 “End Stop Rev” – Forces end reverse travel limit. Bit 6 “PHdwrOvrTrvl” – Positive Hardware Over Travel limit: Setting this bit creates a Coast to Stop fault. Bit 7 “NHdwrOvrTrvl” – Negative Hardware Over Travel limit: Setting this bit creates a Coast to Stop fault.		Reserved	Reserved	Reserved	Reserved	Reserved	Reserved	Reserved	Reserved	NHdwrOvrTrvl	PHdwrOvrTrvl	End Stop Rev	Decel Rev	End Stop Fwd	Decel Fwd	Float Micro	Fast Stop	Default	0	0	0	0	0	0	0	0	0	0	0	0	0	0	0	0	Bit	15	14	13	12	11	10	9	8	7	6	5	4	3	2	1	0	RW	16-bit Integer		
	Reserved	Reserved	Reserved	Reserved	Reserved	Reserved	Reserved	Reserved	NHdwrOvrTrvl	PHdwrOvrTrvl	End Stop Rev	Decel Rev	End Stop Fwd	Decel Fwd	Float Micro	Fast Stop																																								
Default	0	0	0	0	0	0	0	0	0	0	0	0	0	0	0	0																																								
Bit	15	14	13	12	11	10	9	8	7	6	5	4	3	2	1	0																																								








File	Group	No.	Display Name Full Name Description	Values	Read-Write	Data Type																																																			
APPLICATIONS	Torque Prove	1102	<b>755 DI FloatMicroPsn</b>  Digital Input Float Micro Position Selects the digital input to be used for the float and micro position functions. Activates the micro position function when selected and running. Activates float when stopping.	Default: 0.00 Min/Max: 0.00 / 159999.15	RW	32-bit Integer																																																			
		1103	<b>755 Trq Prove Status</b>  Torque Prove Status Displays the status bits for TorqProve.  Options <table border="1" style="margin-left: 20px;"> <thead> <tr> <th></th> <th>Reserved</th> <th>Reserved</th> <th>Reserved</th> <th>Reserved</th> <th>Reserved</th> <th>Reserved</th> <th>Reserved</th> <th>BrakeRelease</th> <th>Encoderless</th> <th>RefLoadLmted</th> <th>LoadTestActv</th> <th>Brake Set</th> <th>BrkSlip1 Alm</th> <th>Micro Psn</th> <th>DecelLmtActv</th> <th>EndLimitActv</th> </tr> </thead> <tbody> <tr> <td>Default</td> <td>0</td> <td>0</td> <td>0</td> <td>0</td> <td>0</td> <td>0</td> <td>0</td> <td>0</td> <td>0</td> <td>0</td> <td>0</td> <td>0</td> <td>0</td> <td>0</td> <td>0</td> <td>0</td> </tr> <tr> <td>Bit</td> <td>15</td> <td>14</td> <td>13</td> <td>12</td> <td>11</td> <td>10</td> <td>9</td> <td>8</td> <td>7</td> <td>6</td> <td>5</td> <td>4</td> <td>3</td> <td>2</td> <td>1</td> <td>0</td> </tr> </tbody> </table> 0 = Disabled 1 = Enabled  Bit 0 "EndLimitActv" – End travel limit active. Bit 1 "DecelLmtActv" – Decel travel limit active. Bit 2 "Micro Psn" – Micro position active. Bit 3 "BrkSlip1 Alm" – Brake slip detected. Bit 4 "Brake Set" – Brake signal set. For example set P10 [R00 Sel] on the digital I/O module to Port 0, P1103 Bit 4 and set P6 [Dig Out Invert] Bit 0 = 1. Bit 5 "LoadTestActv" – The test used to check the load for above base speed operation is active. Bit 6 "RefLoadLmted" – The reference is limited due to the load test results. Bit 7 "Encoderless" – Encoderless configure fault is active. Bit 8 "BrakeRelease" – Inverted state of P1103 Bit 4.		Reserved	Reserved	Reserved	Reserved	Reserved	Reserved	Reserved	BrakeRelease	Encoderless	RefLoadLmted	LoadTestActv	Brake Set	BrkSlip1 Alm	Micro Psn	DecelLmtActv	EndLimitActv	Default	0	0	0	0	0	0	0	0	0	0	0	0	0	0	0	0	Bit	15	14	13	12	11	10	9	8	7	6	5	4	3	2	1	0	Default: 0.00 Min/Max: 0.00 / 159999.15	RO	16-bit Integer
			Reserved	Reserved	Reserved	Reserved	Reserved	Reserved	Reserved	BrakeRelease	Encoderless	RefLoadLmted	LoadTestActv	Brake Set	BrkSlip1 Alm	Micro Psn	DecelLmtActv	EndLimitActv																																							
		Default	0	0	0	0	0	0	0	0	0	0	0	0	0	0	0	0																																							
		Bit	15	14	13	12	11	10	9	8	7	6	5	4	3	2	1	0																																							
		1104	<b>755 Trq Lmt SlewRate</b> Torque Limit Slew Rate Sets the rate to ramp the torque limits to zero during brake proving.	Units: Secs Default: 10.000 Min/Max: 0.500 / 300.000	RW	Real																																																			
		1105	<b>755 Speed Dev Band</b> Speed Deviation Band The amount of allowable deviation between the commanded speed and the actual speed (from a feedback device). When this value is exceeded for the amount of time in P1106 [SpdBand Intgrtr], a fault will occur.	Units: Hz RPM Default: P27 [Motor NP Hertz] x 0.0334 P28 [Motor NP RPM] x 0.0334 Min/Max: P27 x 0.0016 / P27 x 0.25 P28 x 0.0016 / P28 x 0.25	RW	Real																																																			
		1106	<b>755 SpdBand Intgrtr</b> Speed Band Integrator The amount of time for which the actual speed is allowed to deviate from P1105 [Speed Dev Band] before a fault occurs.	Units: Secs Default: 0.060 Min/Max: 0.001 / 0.200	RW	Real																																																			
		1107	<b>755 Brk Release Time</b> Brake Release Time With an encoder, this parameter sets the time between the brake release command and when the drive begins to accelerate. Without an encoder, this parameter sets the time to release the brake after drive starts.	Units: Secs Default: 0.100 Min/Max: 0.000 / 10.000	RW	Real																																																			
1108	<b>755 Brk Set Time</b> Brake Set Time Defines the amount of delay time between commanding the brake to be set and the start of brake proving.	Units: Secs Default: 0.100 Min/Max: 0.000 / 10.000	RW	Real																																																					
1109	<b>755 Brk Alarm Travel</b> Brake Alarm Travel Sets the number of motor shaft revolutions allowed during the brake slippage test. Drive torque is reduced to check for brake slippage. When slippage occurs, the drive allows this number of motor shaft revolutions before regaining control. Not used when P1100 [Trq Prove Cfg] Bit 1 "Encoderless" = 1 (enabled).	Default: 1.00 Min/Max: 0.00 / 1000.00	RW	Real																																																					







File	Group	No.	Display Name Full Name Description	Values		Read-Write	Data Type
APPLICATIONS	Torque Prove	1110	<b>755 Brk Slip Count</b> Brake Slip Count Sets the number of encoder counts to define a brake slippage condition and is based on the feedback device attached to P135 [Position Feedback]. Not used when P1100 [Trq Prove Cfg] Bit 1 "Encoderless" = 1 (enabled).	Default: 250.00 Min/Max: 0.00 / 2147480000		RW	Real
		1111	<b>755 Float Tolerance</b> Float Tolerance Sets the frequency or speed level where the float timer starts. Also sets the frequency or speed level where the brake will be closed when P1100 [Trq Prove Cfg] Bit 1 "Encoderless" = 1 (enabled).	Units: Hz RPM Default: P27 [Motor NP Hertz] x 0.0334 P28 [Motor NP RPM] x 0.0334 Min/Max: P27 [Motor NP Hertz] / P27 x 0.25 P28 [Motor NP RPM] x 0.001 / P28 x 0.25		RW	Real
		1112	<b>755 MicroPsnScalePct</b>  Micro Position Scale Percent Sets the percent of speed reference to be used when micropositioning has been selected in P1100 [Trq Prove Cfg]. Bit 2 of P1100 [Trq Prove Cfg], determines if the motor needs to come to a stop before this setting will take effect.	Units: % Default: 10.000 Min/Max: 0.100 / 100.000		RW	Real
		1113	<b>755 ZeroSpdFloatTime</b> Zero Speed Float Time Sets the amount of time the drive is below P1111 [Float Tolerance] before the brake is set. Not used when P1100 [Trq Prove Cfg] Bit 1 "Encoderless" = 1 (enabled).	Units: Secs Default: 5.000 Min/Max: 0.100 / 500.000		RW	Real
		1114	<b>755 Brake Test Torq</b> Brake Test Torque Sets the percent of torque applied to the motor before the brake is released when P1100 [Trq Prove Cfg] bit 7 "Test Brake" is enabled.	Units: % Default: 50.0 Min/Max: -150 / +150.0		RW	Real










File	Group	No.	Display Name Full Name Description	Values	Read-Write	Data Type																																																						
APPLICATIONS	Fibers Function	1120	<b>Fiber Control</b> Fiber Control Controls the Sync and Traverse Fiber Application functions.  Options <table border="1"> <tr> <td></td> <td>Reserved</td><td>Reserved</td><td>Reserved</td><td>Reserved</td><td>Reserved</td><td>Reserved</td><td>Reserved</td><td>Reserved</td><td>Reserved</td><td>Reserved</td><td>Reserved</td><td>Reserved</td><td>Reserved</td><td>Reserved</td><td>Reserved</td><td>Traverse Ena</td><td>Sync Enable</td> </tr> <tr> <td>Default</td> <td>0</td><td>0</td><td>0</td><td>0</td><td>0</td><td>0</td><td>0</td><td>0</td><td>0</td><td>0</td><td>0</td><td>0</td><td>0</td><td>0</td><td>0</td><td>0</td><td>0</td> </tr> <tr> <td>Bit</td> <td>15</td><td>14</td><td>13</td><td>12</td><td>11</td><td>10</td><td>9</td><td>8</td><td>7</td><td>6</td><td>5</td><td>4</td><td>3</td><td>2</td><td>1</td><td>0</td><td>0</td> </tr> </table>		Reserved	Reserved	Reserved	Reserved	Reserved	Reserved	Reserved	Reserved	Reserved	Reserved	Reserved	Reserved	Reserved	Reserved	Reserved	Traverse Ena	Sync Enable	Default	0	0	0	0	0	0	0	0	0	0	0	0	0	0	0	0	0	Bit	15	14	13	12	11	10	9	8	7	6	5	4	3	2	1	0	0	0 = Disabled 1 = Enabled	RW	16-bit Integer
			Reserved	Reserved	Reserved	Reserved	Reserved	Reserved	Reserved	Reserved	Reserved	Reserved	Reserved	Reserved	Reserved	Reserved	Reserved	Traverse Ena	Sync Enable																																									
		Default	0	0	0	0	0	0	0	0	0	0	0	0	0	0	0	0	0																																									
		Bit	15	14	13	12	11	10	9	8	7	6	5	4	3	2	1	0	0																																									
		1121	<b>Fiber Status</b> Fiber Status Status of Sync and Traverse functions.  Options <table border="1"> <tr> <td></td> <td>Reserved</td><td>Reserved</td><td>Reserved</td><td>Reserved</td><td>Reserved</td><td>Reserved</td><td>Reserved</td><td>Reserved</td><td>Reserved</td><td>Reserved</td><td>Reserved</td><td>Reserved</td><td>Traverse Dec</td><td>Traverse On</td><td>Sync Ramp</td><td>Sync Hold</td> </tr> <tr> <td>Default</td> <td>0</td><td>0</td><td>0</td><td>0</td><td>0</td><td>0</td><td>0</td><td>0</td><td>0</td><td>0</td><td>0</td><td>0</td><td>0</td><td>0</td><td>0</td><td>0</td> </tr> <tr> <td>Bit</td> <td>15</td><td>14</td><td>13</td><td>12</td><td>11</td><td>10</td><td>9</td><td>8</td><td>7</td><td>6</td><td>5</td><td>4</td><td>3</td><td>2</td><td>1</td><td>0</td> </tr> </table>		Reserved	Reserved	Reserved	Reserved	Reserved	Reserved	Reserved	Reserved	Reserved	Reserved	Reserved	Reserved	Traverse Dec	Traverse On	Sync Ramp	Sync Hold	Default	0	0	0	0	0	0	0	0	0	0	0	0	0	0	0	0	Bit	15	14	13	12	11	10	9	8	7	6	5	4	3	2	1	0	0 = Disabled 1 = Enabled	RO	16-bit Integer			
	Reserved	Reserved	Reserved	Reserved	Reserved	Reserved	Reserved	Reserved	Reserved	Reserved	Reserved	Reserved	Traverse Dec	Traverse On	Sync Ramp	Sync Hold																																												
Default	0	0	0	0	0	0	0	0	0	0	0	0	0	0	0	0																																												
Bit	15	14	13	12	11	10	9	8	7	6	5	4	3	2	1	0																																												
1122	<b>Sync Time</b> Synchronize Time The time in seconds to ramp from the "held speed reference" to the current speed reference, after the Sync input is de-energized.	Units: Secs Default: 0.0 Min/Max: 0.0 / 3600.0	RW	Real																																																								
1123	<b>Traverse Inc</b> Traverse Increment Sets the time period in seconds of increasing speed for the Fiber Traverse function.	Units: Secs Default: 0.00 Min/Max: 0.00 / 30.00	RW	Real																																																								
1124	<b>Traverse Dec</b> Traverse Decrement Sets the time period in seconds of decreasing speed for the Fiber Traverse function.	Units: Secs Default: 0.00 Min/Max: 0.00 / 30.00	RW	Real																																																								
1125	<b>Max Traverse</b> Maximum Traverse Sets the amplitude of the triangle wave speed modulation for the Fiber Traverse function. The total speed variation will be twice this value, from speed ref plus Max Traverse to speed ref minus Max Traverse.	Units: Hz RPM Default: 0.00 Min/Max: 0.00 / P520 [Max Fwd Speed]	RW	Real																																																								


File	Group	No.	Display Name Full Name Description	Values	Read-Write	Data Type
APPLICATIONS	Fibers Function	1126	<b>P Jump</b> Position Jump Sets the amplitude of the square wave speed modulation for the Fiber Traverse function. This speed is alternately added to and subtracted from the speed reference together with the P1125 [Max Traverse] triangle speed modulation.	Units: Hz RPM Default: 0.00 Min/Max: 0.00 / P520 [Max Fwd Speed]	RW	Real
		1129	 <b>DI Fiber SyncEna</b> Digital Input Fiber Synchronize Enable Selects a digital input source for the Fiber Application Function's synchronous speed change routine. Used in combination with the P1120 [Fiber Control] Sync Enable bit.	Default: 0.00 Min/Max: 0.00 / 159999.15	RW	32-bit Integer
		1130	 <b>DI Fiber TravDis</b> Digital Input Fiber Traverse Disable Selects a digital input source for the Fiber Application Traverse Routine. This is an inverted input, so the Traverse Routine is disabled when the input is active (set). Used in combination with P1120 [Fiber Control] Bit 1 "Traverse Ena."	Default: 0.00 Min/Max: 0.00 / 159999.15	RW	32-bit Integer

File	Group	No.	Display Name Full Name Description	Values	Read-Write	Data Type																																																									
APPLICATIONS	Adjustable Vltg	1131	 <b>Adj Vltg Config</b> Adjustable Voltage Configuration Selects output voltage phase setting. Single-phase operation is intended for resistive loads such as heating coils. Connect single-phase loads across the U/T1 and V/T2 output terminals.  Options <table border="1" style="display: inline-table; vertical-align: middle;"> <tr> <td></td> <td>Reserved</td><td>Reserved</td><td>Reserved</td><td>Reserved</td><td>Reserved</td><td>Reserved</td><td>Reserved</td><td>Reserved</td><td>Reserved</td><td>Reserved</td><td>Reserved</td><td>Reserved</td><td>Reserved</td><td>Reserved</td><td>Reserved</td><td>Reserved</td><td>Reserved</td><td>PhaseSetting</td> </tr> <tr> <td>Default</td> <td>0</td><td>0</td><td>0</td><td>0</td><td>0</td><td>0</td><td>0</td><td>0</td><td>0</td><td>0</td><td>0</td><td>0</td><td>0</td><td>0</td><td>0</td><td>0</td><td>0</td><td>1</td> </tr> <tr> <td>Bit</td> <td>15</td><td>14</td><td>13</td><td>12</td><td>11</td><td>10</td><td>9</td><td>8</td><td>7</td><td>6</td><td>5</td><td>4</td><td>3</td><td>2</td><td>1</td><td>0</td><td></td><td></td> </tr> </table> 0 = 3-Phase Operation 1 = 1-Phase Operation		Reserved	Reserved	Reserved	Reserved	Reserved	Reserved	Reserved	Reserved	Reserved	Reserved	Reserved	Reserved	Reserved	Reserved	Reserved	Reserved	Reserved	PhaseSetting	Default	0	0	0	0	0	0	0	0	0	0	0	0	0	0	0	0	0	1	Bit	15	14	13	12	11	10	9	8	7	6	5	4	3	2	1	0				RW	16-bit Integer
			Reserved	Reserved	Reserved	Reserved	Reserved	Reserved	Reserved	Reserved	Reserved	Reserved	Reserved	Reserved	Reserved	Reserved	Reserved	Reserved	Reserved	PhaseSetting																																											
		Default	0	0	0	0	0	0	0	0	0	0	0	0	0	0	0	0	0	1																																											
		Bit	15	14	13	12	11	10	9	8	7	6	5	4	3	2	1	0																																													
		1133	 <b>Adj Vltg Select</b> Adjustable Voltage Reference Select Selects the source of the voltage reference to the drive.	Default: 0 Min/Max: 0 / 159999	RW	32-bit Integer																																																									
		1134	<b>Adj Vltg Ref Hi</b> Adjustable Voltage Reference High Scales the upper value of the P1133 [Adj Vltg Select] selection when the source is an analog input.	Units: % Default: 0.0 Min/Max: 0 / 100.0 of Drive Rated Volts	RW	Real																																																									
		1135	<b>Adj Vltg Ref Lo</b> Adjustable Voltage Reference Low Scales the lower value of the P1133 [Adj Vltg Select] selection when the source is an analog input.	Units: % Default: 0.0 Min/Max: 0 / 100.0 of Drive Rated Volts	RW	Real																																																									
1136	 <b>Adj Vltg TrimSel</b> Adjustable Voltage Trim Select Selects the source of the voltage trim that is added to or subtracted from the voltage reference.	Default: 0 Min/Max: 0 / 159999	RW	32-bit Integer																																																											
1137	<b>Adj Vltg Trim Hi</b> Adjustable Voltage Trim High Scales the upper value of the P1136 [Adj Vltg TrimSel] selection when the source is an analog input.	Units: % Default: 0.0 Min/Max: 0 / 100.0 of Drive Rated Volts	RW	Real																																																											
1138	<b>Adj Vltg Trim Lo</b> Adjustable Voltage Trim Low Scales the lower value of the P1136 [Adj Vltg TrimSel] selection when the source is an analog input.	Units: % Default: 0.0 Min/Max: 0 / 100.0 of Drive Rated Volts	RW	Real																																																											

File	Group	No.	Display Name Full Name Description	Values		Read-Write	Data Type
APPLICATIONS	Adjustable Vltg	1139	<b>Adj Vltg Command</b> Adjustable Voltage Command Displays the voltage value of the reference specified in P1133 [Adj Vltg Select].	Units: Default: Min/Max:	V AC 0.00 0.00 / Drive Rated Volts	RO	Real
		1140	<b>Adj Vltg AccTime</b> Adjustable Voltage Acceleration Time Sets the rate of voltage increase. The value will be the time it takes to ramp the voltage from P1152 [Min Adj Voltage] to P36 [Maximum Voltage]. An "S" curve can be applied to the ramp using P1150 [Adj Volt Scurve].	Units: Default: Min/Max:	Secs 0.0 0.0 / 3600.0	RW	Real
		1141	<b>Adj Vltg DecTime</b> Adjustable Voltage Deceleration Time Sets the rate of voltage decrease. The value will be the time it takes to ramp the voltage from P36 [Maximum Voltage] to P1152 [Min Adj Voltage]. An "S" curve can be applied to the ramp using P1150 [Adj Volt Scurve]. This is an independent voltage ramp decoupled from the scalar frequency ramp P537/538 [Decel Time <i>n</i> ] and controlled by user selectable acceleration and deceleration ramp times. <b>Important:</b> This ramp and P537/538 [Decel Time <i>n</i> ] must ramp to zero for drive to Stop.	Units: Default: Min/Max:	Secs 0.0 0.0 / 3600.0	RW	Real
		1142	<b>Adj Vltg Preset1</b>	Units: Default: Min/Max:	V AC 0.0 0.0 / Based on Drive Rating and Voltage Class	RW	Real
		1143	<b>Adj Vltg Preset2</b>				
		1144	<b>Adj Vltg Preset3</b>				
		1145	<b>Adj Vltg Preset4</b>				
		1146	<b>Adj Vltg Preset5</b>				
		1147	<b>Adj Vltg Preset6</b>				
		1148	<b>Adj Vltg Preset7</b> Adjustable Voltage Preset <i>n</i> Provides an internal fixed voltage command value that is available as a selection for P1133 [Adj Vltg Select].				
		1149	<b>Adj Vltg RefMult</b> Adjustable Voltage Reference Multiplier Scales the selected reference voltage by a percentage where 100% equals the reference command. If the reference command equals 100V and P1149 equals 100% then the total output voltage equals 100V + 100V = 200V.	Units: Default: Min/Max:	% 0.0 0 / 100.0 of Drive Rated Volts	RW	Real
		1150	<b>Adj Vltg Scurve</b> Adjustable Voltage S Curve Sets the percentage of acceleration time or deceleration time to be applied to the voltage ramp as "S" curve. Time is added 1/2 at the beginning and 1/2 at the end. A value of zero disables this feature.	Units: Default: Min/Max:	% 0.0 0.0 / 100.0	RW	Real
		1151	<b>Adj Vltg TrimPct</b> Adjustable Voltage Trim Percentage Scales the selected trim voltage by a percentage where 100% equals the trim voltage. If the reference command equals 100V and P1151 equals 100% then the total output voltage equals 100V + 100V = 200V. Analog In 1 and 2 are scaled separately with P1137 [Adj Vltg Trim Hi] and P1138 [Adj Vltg Trim Lo] then P1151 sets the trim value. The sign of this value will determine if trim is added or subtracted from the reference.	Units: Default: Min/Max:	% 0.0 -/+100.0 of Drive Rated Volts	RW	Real
		1152	<b>Min Adj Voltage</b> Minimum Adjustable Voltage Sets the low limit for the voltage reference when P35 [Motor Ctrl Mode] is set to 9 "Adj Voltage."	Units: Default: Min/Max:	V AC 0.0 0.0 / Drive Rated Volts	RW	Real
1153	 <b>Dead Time Comp</b> Dead Time Compensation Sets the dead time compensation value to reduce DC offsets in the output voltage from the PWM inverter for non-motor loads.	Units: Default: Min/Max:	% 100.00 0.00 / 100.00	RW	Real		
1154	 <b>DC Offset Ctrl</b> DC Offset Control Used to further reduce DC offsets in the output voltage from the PWM inverter for non-motor loads. When enabled, P1153 [Dead Time Comp] is disabled.	Default: Options:	0 = "Disable" 0 = "Disable" 1 = "Enable"	RW	32-bit Integer		


File	Group	No.	Display Name Full Name Description	Values	Read-Write	Data Type																																																
APPLICATIONS	Pump Jack	1165	<b>Rod Speed</b> Rod Speed Displays the speed in RPM of the pump rod after the gearbox and sheaves. Rod Speed = Motor Speed x P1174 [Total Gear Ratio]	Units: RPM Default: 0.00 Min/Max: 0.00 / 10000.00	RO	Real																																																
		1166	<b>Rod Torque</b> Rod Torque Displays the load side torque. P1174 [Total Gear Ratio] must be greater than zero to activate this display.	Units: FtLb Default: 0.00 Min/Max: 0.00 / 10000.00	RO	Real																																																
		1167	<b>Rod Speed Cmd</b> Rod Speed Command Displays the commanded speed in RPM of the pump rod after the gearbox and sheaves.	Units: RPM Default: 0.00 Min/Max: 0.00 / 10000.00	RO	Real																																																
		1168	 <b>TorqAlarm Action</b> Torque Alarm Action Sets the drive action when the Torque Alarm is exceeded. Note: only active with PC pump applications. See P1179 [OilWell Pump Cfg].	Default: 0 = "Ignore" Options: 0 = "Ignore" 1 = "Preset Spd1"	RW	32-bit Integer																																																
		1169	 <b>TorqAlarm Config</b> Torque Alarm Configure  Enables the Torque Alarm function.  Options <table border="1" style="display: inline-table; vertical-align: top;"> <tr> <td></td> <td>Reserved</td><td>Reserved</td><td>Reserved</td><td>Reserved</td><td>Reserved</td><td>Reserved</td><td>Reserved</td><td>Reserved</td><td>Reserved</td><td>Reserved</td><td>Reserved</td><td>Reserved</td><td>Reserved</td><td>Torq Lvl Low</td><td>Torque Level</td> </tr> <tr> <td>Default</td> <td>0</td><td>0</td><td>0</td><td>0</td><td>0</td><td>0</td><td>0</td><td>0</td><td>0</td><td>0</td><td>0</td><td>0</td><td>0</td><td>0</td><td>0</td> </tr> <tr> <td>Bit</td> <td>15</td><td>14</td><td>13</td><td>12</td><td>11</td><td>10</td><td>9</td><td>8</td><td>7</td><td>6</td><td>5</td><td>4</td><td>3</td><td>2</td><td>1</td><td>0</td> </tr> </table>  Bit 0 – Torque Level Bit 1 – Torq Lvl Low  0 = Disabled 1 = Enabled		Reserved	Reserved	Reserved	Reserved	Reserved	Reserved	Reserved	Reserved	Reserved	Reserved	Reserved	Reserved	Reserved	Torq Lvl Low	Torque Level	Default	0	0	0	0	0	0	0	0	0	0	0	0	0	0	0	Bit	15	14	13	12	11	10	9	8	7	6	5	4	3	2	1	0	RW	16-bit Integer
			Reserved	Reserved	Reserved	Reserved	Reserved	Reserved	Reserved	Reserved	Reserved	Reserved	Reserved	Reserved	Reserved	Torq Lvl Low	Torque Level																																					
		Default	0	0	0	0	0	0	0	0	0	0	0	0	0	0	0																																					
		Bit	15	14	13	12	11	10	9	8	7	6	5	4	3	2	1	0																																				
		1170	 <b>TorqAlarm Dwell</b> Torque Alarm Dwell Sets the time that the torque must exceed P1171 [TorqAlarm Level] before P1168 [TorqAlarm Action] takes place. Active when P1169 [TorqAlarm Config] Bit 0 "Torque Level" = 1 (enabled).	Units: Secs Default: 0.0 Min/Max: 0.0 / 60.0	RW	Real																																																
		1171	 <b>TorqAlarm Level</b> Torque Alarm Level Sets the level at which the Torque Alarm becomes active. Active when P1169 [TorqAlarm Config] Bit 0 "Torque Level" = 1 (enabled)	Units: FtLb Default: 0.0 Min/Max: 0.0 / 5000.0	RW	Real																																																
1172	 <b>TorqAlm Timeout</b> Torque Alarm Time Out Sets the amount of time a Torque Alarm can be active until timeout action begins. Active when P1169 [TorqAlarm Config] Bit 0 "Torque Level" = 1 (enabled)	Units: Secs Default: 0.0 Min/Max: 0.0 / 600.0	RW	Real																																																		
1173	 <b>TorqAlarm TOActn</b> Torque Alarm Time Out Action Sets the drive action when P1172 [TorqAlrm Timeout] is exceeded. Active when P1169 [TorqAlarm Config] Bit 0 "Torque Level" = 1 (enabled) "Ignore" (0) – No action is taken. "Alarm" (1) – Type 1 alarm indicated. "Flt Minor" (2) – Minor fault indicated. If running, drive continues to run. Enable with P950 [Minor Flt Cfg]. If not enabled, acts like a major fault. "FltCoastStop" (3) – Major fault indicated. Coast to Stop. "Flt RampStop" (4) – Major fault indicated. Ramp to Stop. "Flt CL Stop" (5) – Major fault indicated. Current Limit Stop.	Default: 0 = "Ignore" Options: 0 = "Ignore" 1 = "Alarm" 2 = "Flt Minor" 3 = "FltCoastStop" 4 = "Flt RampStop" 5 = "Flt CL Stop" 6 = "Resume"	RW	32-bit Integer																																																		

File	Group	No.	Display Name Full Name Description	Values	Read-Write	Data Type
APPLICATIONS	Pump Jack	1174	<b>Total Gear Ratio</b> Total Gear Ratio Displays the calculated total gear ratio as follows: (P1184 [Gearbox Sheave] x P1183 [Gearbox Ratio]) / P1178 [Motor Sheave]	Default: 0.0 Min/Max: 0.0 / 32000.0	RO	Real
		1175	<b>Max Rod Speed</b> Maximum Rod Speed Sets the maximum speed for the polished rod in a PCP oil well application.	Units: RPM Default: 300.0 Min/Max: 200.0 / 600.0	RW	Real
		1176	 <b>Max Rod Torque</b> Maximum Rod Torque Sets the desired maximum torque on the polished rod in a PCP oil well application.	Units: FtLb Default: 500.0 Min/Max: 0.0 / 3000.0	RW	Real
		1177	 <b>Min Rod Speed</b> Minimum Rod Speed Sets the minimum speed for the polished rod in a PCP oil well application.	Units: RPM Default: 0.0 Min/Max: 0.0 / 199.0	RW	Real
		1178	 <b>Motor Sheave</b> Motor Sheave Sets the sheave diameter on the motor.	Units: Inch Default: 10.0 Min/Max: 0.25 / 25.00	RW	Real
		1179	 <b>OilWell Pump Cfg</b> Oil Well Pump Configure Selects the type of oil well application. “Disable” (0) – Disables oil well parameters. “Pump Jack” (1) – Sets parameters based on Pump Jack type oil well. “PrgrsvCavity” (2) – Sets parameters based on Progressive Cavity type Pumps.	Default: 0 = “Disable” Options: 0 = “Disable” 1 = “Pump Jack” 2 = “PrgrsvCavity”	RW	32-bit Integer
		1180	 <b>PCP Pump Sheave</b> PCP Pump Sheave Specifies the pump sheave diameter.	Units: Inch Default: 20.0 Min/Max: 0.25 / 200.00	RW	Real
		1181	 <b>Gearbox Limit</b> Gearbox Limit Sets the gearbox torque limit. This value is used in determining the P670 [Pos Torque Limit] and P671 [Neg Torque Limit].	Units: % Default: 100.0 Min/Max: 0.0 / 200.0	RW	Real
		1182	 <b>Gearbox Rating</b> Gearbox Rating Sets the gearbox rating.	Units: Kin# Default: 640.0 Min/Max: 16.0 / 2560.0	RW	Real
		1183	 <b>Gearbox Ratio</b> Gearbox Ratio Specifies the nameplate gear ratio.	Default: 1.0 Min/Max: 1.0 / 40.0	RW	Real
		1184	 <b>Gearbox Sheave</b> Gearbox Sheave Sets the Sheave diameter on the Gearbox	Units: Inch Default: 0.25 Min/Max: 0.25 / 100.00	RW	Real
1185	<b>TorqAlarm LoLvl</b> Torque Alarm Low Level Sets the level at which the Torque Low Alarm becomes active. Active when P1169 [TorqAlarm Config] Bit 1 “Torq Lvl Low” = 0 (enabled)	Units: FtLb Default: 0.0 Min/Max: 0.0/5000.0	RW	Real		

File	Group	No.	Display Name Full Name Description	Values	Read-Write	Data Type																																																			
APPLICATIONS	Pump Off	1187	<b>Pump Off Config</b> Pump Off Configure Selects the torque data that will be used for the pump off control. "Automatic" (0) – Downstroke torque is used if the torque waveform synchronizes with previously saved waveform. If the position is not found after 6 cycles, the cycle torque is used. If cycle torque is used, P1191 [Pump Off Status] Bit 3 "Cycle Used" is set to 1 "Enable." "Position" (1) – Downstroke torque is used to detect a pump off condition. The torque waveform needs to be able to synchronize with the previously saved waveform. "Cycle" (2) – Full pump cycle torque is used to detect a pump off condition.	Default: 0 = "Automatic" Options: 0 = "Automatic" 1 = "Position" 2 = "Cycle"	RW	32-bit Integer																																																			
		1188	 <b>Pump Off Setup</b> Pump Off Setup Select pump off options.	<table border="1"> <thead> <tr> <th>Options</th> <th>Reserved</th> <th>Reserved</th> <th>Reserved</th> <th>Reserved</th> <th>Reserved</th> <th>Reserved</th> <th>Reserved</th> <th>Reserved</th> <th>Reserved</th> <th>Reserved</th> <th>Reserved</th> <th>Dis Baseline</th> <th>Cycle PO Pos</th> <th>Pos Min Trq</th> <th>Pos Offset</th> <th>Pos Filter</th> </tr> </thead> <tbody> <tr> <td>Default</td> <td>0</td> <td>0</td> <td>0</td> <td>0</td> <td>0</td> <td>0</td> <td>0</td> <td>0</td> <td>0</td> <td>0</td> <td>0</td> <td>0</td> <td>0</td> <td>0</td> <td>0</td> <td>0</td> </tr> <tr> <td>Bit</td> <td>15</td> <td>14</td> <td>13</td> <td>12</td> <td>11</td> <td>10</td> <td>9</td> <td>8</td> <td>7</td> <td>6</td> <td>5</td> <td>4</td> <td>3</td> <td>2</td> <td>1</td> <td>0</td> </tr> </tbody> </table> 0 = Disabled 1 = Enabled	Options	Reserved	Reserved	Reserved	Reserved	Reserved	Reserved	Reserved	Reserved	Reserved	Reserved	Reserved	Dis Baseline	Cycle PO Pos	Pos Min Trq	Pos Offset	Pos Filter	Default	0	0	0	0	0	0	0	0	0	0	0	0	0	0	0	0	Bit	15	14	13	12	11	10	9	8	7	6	5	4	3	2	1	0	RW	16-bit Integer
		Options	Reserved	Reserved	Reserved	Reserved	Reserved	Reserved	Reserved	Reserved	Reserved	Reserved	Reserved	Dis Baseline	Cycle PO Pos	Pos Min Trq	Pos Offset	Pos Filter																																							
		Default	0	0	0	0	0	0	0	0	0	0	0	0	0	0	0	0																																							
Bit	15	14	13	12	11	10	9	8	7	6	5	4	3	2	1	0																																									
1189	<b>Pump Off Action</b> Pump Off Action Selects the action to be taken after a pump off condition has been detected. "Change Speed" (0) – When a pump off condition is detected, speed is reduced by the percentage set in P1196 [Pump Off Speed] and runs for the time set in P1197 [Pump Off Time]. If condition continues, speed is reduced a second time. The pump will remain at this speed until the pump off condition no longer exists. "Always Stop" (1) – Stops pump when a pump off condition is detected. Pump will remain stopped for the time set in P355 [Wake Time]. "Stop After 1" (2) – When a pump off condition is detected, speed is reduced by the percentage set in P1196 [Pump Off Speed] and runs for the time set in P1197 [Pump Off Time]. Pump will stop if torque continues to change while at the reduced speed. Pump will remain stopped for the time set in P353 [Sleep Time]. "Stop After 2" (3) – When a pump off condition is detected, speed is reduced by the percentage set in P1196 [Pump Off Speed] and runs for the time set in P1197 [Pump Off Time]. If torque change continues, speed is reduced a second time by the same percentage. Pump will stop if torque continues to change while at the reduced speed. Pump will remain stopped for the time entered in P353 [Sleep Time].	Default: 0 = "Change Speed" Options: 0 = "Change Speed" 1 = "Always Stop" 2 = "Stop After 1" 3 = "Stop After 2"	RW	32-bit Integer																																																					
1190	<b>Pump Off Control</b> Pump Off Control Enables/Disable the pump off control or select the source for the torque level. "Baseline Set" (1) – The control uses a torque baseline created after any start of the drive (first ten cycles). It is critical that this data is gathered from a "full" well. "Fixed Setpt" (2) – The control uses the value set in P1194 [Torque Setpoint]. Use the value in P1200 [Pct Drop Torque] as a guideline in "Automatic" or "Position" mode. In "Cycle" mode use P1198 [Pct Cycle Torque] as a guideline.	Default: 0 = "Disable" Options: 0 = "Disable" 1 = "Baseline Set" 2 = "Fixed Setpt"	RW	32-bit Integer																																																					












File	Group	No.	Display Name Full Name Description	Values	Read-Write	Data Type																																																			
APPLICATIONS	Pump Off	1191	<p><b>Pump Off Status</b> Pump Off Status Displays the status of the pump off control.</p> <p>Options</p> <table border="1"> <tr> <td></td> <td>Reserved</td> <td>Reserved</td> <td>Reserved</td> <td>Reserved</td> <td>Reserved</td> <td>Reserved</td> <td>Reserved</td> <td>Reserved</td> <td>Reserved</td> <td>Pump Stable</td> <td>Pump Off Alarm</td> <td>TopOfStroke</td> <td>Cycle Used</td> <td>Pump Stopped</td> <td>Pump Slowed</td> <td>Pump OffEnbl</td> </tr> <tr> <td>Default</td> <td>0</td> <td>0</td> <td>0</td> <td>0</td> <td>0</td> <td>0</td> <td>0</td> <td>0</td> <td>0</td> <td>0</td> <td>0</td> <td>0</td> <td>0</td> <td>0</td> <td>0</td> <td>0</td> </tr> <tr> <td>Bit</td> <td>15</td> <td>14</td> <td>13</td> <td>12</td> <td>11</td> <td>10</td> <td>9</td> <td>8</td> <td>7</td> <td>6</td> <td>5</td> <td>4</td> <td>3</td> <td>2</td> <td>1</td> <td>0</td> </tr> </table> <p>0 = Condition False 1 = Condition True</p> <p>Bit 0 "Pump OffEnbl" – Pump off control is enabled.                      Bit 1 "Pump Slowed" – A pump off condition was detected and the drive is running at a reduced speed.                      Bit 2 "Pump Stopped" – A pump off condition was detected and the drive stopped (sleeping).                      Bit 3 "Cycle Used" – The cycle torque is used for pump off detection.                      Bit 4 "TopOfStroke" – The internal position is between 0 and 500. Top of stroke is 0.                      Bit 5 "PumpOff Alarm" – A pump off condition was detected, but has not yet triggered P1189 [Pump Off Action]. This is a warning of a pending pump off condition.                      Bit 6 "Pump Stable" – The pump is running at a stable speed and not calculating the baseline torque.</p>		Reserved	Reserved	Reserved	Reserved	Reserved	Reserved	Reserved	Reserved	Reserved	Pump Stable	Pump Off Alarm	TopOfStroke	Cycle Used	Pump Stopped	Pump Slowed	Pump OffEnbl	Default	0	0	0	0	0	0	0	0	0	0	0	0	0	0	0	0	Bit	15	14	13	12	11	10	9	8	7	6	5	4	3	2	1	0		RO	16-bit Integer
			Reserved	Reserved	Reserved	Reserved	Reserved	Reserved	Reserved	Reserved	Reserved	Pump Stable	Pump Off Alarm	TopOfStroke	Cycle Used	Pump Stopped	Pump Slowed	Pump OffEnbl																																							
		Default	0	0	0	0	0	0	0	0	0	0	0	0	0	0	0	0																																							
		Bit	15	14	13	12	11	10	9	8	7	6	5	4	3	2	1	0																																							
		1192	<p><b>Pump Cycle Store</b> Pump Cycle Store Stores the torque waveform over the course of a pump cycle. Used to determine the downstroke when in "Automatic" or "Position" mode.                      With the drive running at the desired speed, set this parameter to 1 "Enable" and press Enter. Over the next few cycles, the waveform will be stored and this parameter will automatically return to 0 "Disable."                      If this parameter does not return to 0 "Disable" after five pump cycles, waveform variations may be excessive. Use of a fixed setpoint may be required. See the PowerFlex 750-Series AC Drives Reference Manual, publication <a href="#">750-RM002</a>, for more information on setting up the pump off feature.</p>	Default: 0 = "Disable" Options: 0 = "Disable" 1 = "Enable"	RW	32-bit Integer																																																			
1193	<p><b>Set Top ofStroke</b> Set Top of Stroke Captures the position at the top of the pump stroke cycle.                      With the drive running at the desired speed, set this parameter to 1 "Enable" and press Enter when the rod is at its highest position. The top of pump stroke position will be stored and this parameter will automatically return to 0 "Disable."</p>	Default: 0 = "Disable" Options: 0 = "Disable" 1 = "Enable"	RW	32-bit Integer																																																					
1194	<p><b>Torque Setpoint</b> Torque Set Point Sets the torque level for pump off when P1190 [Pump Off Control] is set to 2 "Fixed Setpt."</p>	Units: % Default: 0.00 Min/Max: 0.00 / 100.00	RW	Real																																																					
1195	<p><b>Pump Off Level</b> Pump Off Level Sets the percent change in torque from the baseline or setpoint that will indicate the well is in the pump off condition.                      When the pump is started it creates a baseline torque level, assuming the well is full. For example, if the baseline torque is 50% and the [Pump Off Level] is set to 10%, the drive will go into pump off when the torque drops to 45%.</p>	Units: % Default: 5.00 Min/Max: 0.00 / 100.00	RW	Real																																																					

File	Group	No.	Display Name Full Name Description	Values		Read-Write	Data Type
				Units:			
APPLICATIONS	Pump Off	1196	<b>Pump Off Speed</b> Pump Off Speed Sets the percent drop in speed from the commanded speed during a pump off condition.	Units: % Default: 20.00 Min/Max: 0.00 / 100.00		RW	Real
		1197	<b>Pump Off Time</b> Pump Off Time Sets the time the drive will run at the reduced P1196 [Pump Off Speed] before returning to the commanded speed and checking if the pump off condition still exists.	Units: Secs Default: 600.00 Min/Max: 120.00 / 60000.00		RW	Real
		1198	<b>Pct Cycle Torque</b> Percent Cycle Torque Displays the average torque for a full pump cycle.	Units: % Default: 0.00 Min/Max: -100.00 / 200.00		RO	Real
		1199	<b>Pct Lift Torque</b> Percent Lift Torque Displays the average rod lift torque.	Units: % Default: 0.00 Min/Max: -100.00 / 200.00		RO	Real
		1200	<b>Pct Drop Torque</b> Percent Drop Torque Displays the average rod dropping torque.	Units: % Default: 0.00 Min/Max: -100.00 / 200.00		RO	Real
		1201	<b>Stroke Pos Count</b> Stroke Position Count Displays the pump cycle position. The top of stroke should be 0 and rolls over at 10,000.	Default: 0 Min/Max: 0 / 15000		RO	32-bit Integer
		1202	<b>Stroke Per Min</b> Stroke Per Minute Displays the strokes per minute.	Default: 0.00 Min/Max: 0.00 / 50.00		RO	Real
		1203	<b>Pump Off Count</b> Pump Off Count Displays the number of times a pump off condition has occurred since this parameter was reset.	Default: 0.00 Min/Max: 0.00 / 60000.00		RW	Real
		1204	<b>PumpOff SleepCnt</b> Pump Off Sleep Count Displays the number of times a sleep condition has occurred since this parameter was reset.	Default: 0.00 Min/Max: 0.00 / 60000.00		RW	Real
		1205	<b>Day Stroke Count</b> Day Stroke Count Displays the number of strokes for the past 24 hours. This is a rolling counter updated every hour.	Default: 0.00 Min/Max: 0.00 / 65535.00		RO	Real
		1206	 <b>DI PumpOff Disbl</b> Digital Input Pump Off Disable Selects the digital input source for the Pump Off Disable function.	Default: 0.00 Min/Max: 0.00 / 159999.15		RW	32-bit Integer
		1207	<b>Pump OffSleepLvl</b> Pump Off Sleep Level Provides a source for P351 [SleepWake RefSel]. This provides the start/stop control of the drive by the pump off function.	Units: Volt Default: 0.00 Min/Max: 0.00 / 10.00		RO	Real
		1208	<b>DI Pump Baseline</b> Digital Input Pump Baseline Selects the digital input source for the Pump Baseline Disable Function.	Default: 0.00 Min/Max: 0.00 / 159999.15		RW	32-bit Integer

File	Group	No.	Display Name Full Name Description	Values	Read-Write	Data Type																																																																																																						
APPLICATIONS	Profiling	1210	<p><b>755 Profile Status</b></p> <p>Profile Status</p> <p>Indicates status of speed profile/position indexer control logic.</p> <p>Options</p> <table border="1"> <thead> <tr> <th></th> <th>Reserved</th> <th>Reserved</th> <th>Reserved</th> <th>Reserved</th> <th>Reserved</th> <th>Reserved</th> <th>Reserved</th> <th>Reserved</th> <th>Reserved</th> <th>Reserved</th> <th>Reserved</th> <th>Reserved</th> <th>Reserved</th> <th>Home Not Set</th> <th>Vel Override</th> <th>Restart Step</th> <th>Resume</th> <th>Stopped</th> <th>Complete</th> <th>In Position</th> <th>Holding</th> <th>Dwell</th> <th>PositionMode</th> <th>Running</th> <th>Enabled</th> <th>Reserved</th> <th>Reserved</th> <th>Reserved</th> <th>Step Bit 4</th> <th>Step Bit 3</th> <th>Step Bit 2</th> <th>Step Bit 1</th> <th>Step Bit 0</th> </tr> </thead> <tbody> <tr> <td>Default</td> <td>0</td> <td>0</td> <td>0</td> <td>0</td> <td>0</td> <td>0</td> <td>0</td> <td>0</td> <td>0</td> <td>0</td> <td>0</td> <td>0</td> <td>0</td> <td>0</td> <td>0</td> <td>0</td> <td>0</td> <td>0</td> <td>0</td> <td>0</td> <td>0</td> <td>0</td> <td>0</td> <td>0</td> <td>0</td> <td>0</td> <td>0</td> <td>0</td> <td>0</td> <td>0</td> <td>0</td> <td>0</td> <td>0</td> <td>0</td> </tr> <tr> <td>Bit</td> <td>31</td> <td>30</td> <td>29</td> <td>28</td> <td>27</td> <td>26</td> <td>25</td> <td>24</td> <td>23</td> <td>22</td> <td>21</td> <td>20</td> <td>19</td> <td>18</td> <td>17</td> <td>16</td> <td>15</td> <td>14</td> <td>13</td> <td>12</td> <td>11</td> <td>10</td> <td>9</td> <td>8</td> <td>7</td> <td>6</td> <td>5</td> <td>4</td> <td>3</td> <td>2</td> <td>1</td> <td>0</td> </tr> </tbody> </table> <p style="text-align: right;">0 = Condition False 1 = Condition True</p> <p>Bit 0 "Step Bit 0" – Bit 0 through Bit 4 indicate executing step number in the move table in binary format.                      Bit 1 "Step Bit 1"                      Bit 2 "Step Bit 2"                      Bit 3 "Step Bit 3"                      Bit 4 "Step Bit 4"                      Bit 8 "Enabled" – Indicates that the profile control logic is enabled. When the drive is started with the profiler selection (Option 6) in the speed/torque/position mode P313 [Actv SpTqPs Mode], this bit turns on.                      Bit 9 "Running" – Indicates that the profile control logic is in running state.                      Bit 10 "PositionMode" – Indicates that the profile control logic is using position control logic.                      Bit 11 "Dwell" – Indicates that the profile control logic is in dwell state.                      Bit 12 "Holding" – Indicates that the profile control logic is in holding states                      Bit 13 "In Position" – Indicates that the target position has been reached at the completion of a move. The in position bandwidth P726 [In Pos Psn Band] can be adjusted to affect when this bit is set with respect to the target position. This bit will be cleared when a new move is begun. The status of this bit is not meaningful when using blended steps.                      Bit 14 "Complete" – Indicates that all steps in the move table have been executed and a step with a End action has been reached. The profile control logic is complete. This bit will be cleared when the profile is first enabled.                      Bit 15 "Stopped" – Indicates that the profile control logic stops the drive following Bit 14 "Complete" and any additional dwell time specified for the End step. This bit will be cleared when a new profile is begun.                      Bit 16 "Resume" – Indicates that an existing step is to resume execution when the profile is enabled. A previously running step will then be allowed to complete. When the bit is clear, the profile will begin at its Starting Step.                      Bit 17 "Restart Step" – Follows the state of the restart step bit in P1213 [Profile Command] Bit 10 "Restart Step."                      Bit 18 "Vel Override" – Follows the state of the velocity override bit in P1213 [Profile Command] Bit 9 "Vel Override."                      Bit 19 "Home Not Set" – Indicates that the home position is not defined and the move table contains a position absolute move type. When this bit is set the profile will not be allowed to execute. This bit will be cleared when either a homing function or position redefine function is completed.</p>		Reserved	Reserved	Reserved	Reserved	Reserved	Reserved	Reserved	Reserved	Reserved	Reserved	Reserved	Reserved	Reserved	Home Not Set	Vel Override	Restart Step	Resume	Stopped	Complete	In Position	Holding	Dwell	PositionMode	Running	Enabled	Reserved	Reserved	Reserved	Step Bit 4	Step Bit 3	Step Bit 2	Step Bit 1	Step Bit 0	Default	0	0	0	0	0	0	0	0	0	0	0	0	0	0	0	0	0	0	0	0	0	0	0	0	0	0	0	0	0	0	0	0	0	0	Bit	31	30	29	28	27	26	25	24	23	22	21	20	19	18	17	16	15	14	13	12	11	10	9	8	7	6	5	4	3	2	1	0		RO	32-bit Integer
			Reserved	Reserved	Reserved	Reserved	Reserved	Reserved	Reserved	Reserved	Reserved	Reserved	Reserved	Reserved	Reserved	Home Not Set	Vel Override	Restart Step	Resume	Stopped	Complete	In Position	Holding	Dwell	PositionMode	Running	Enabled	Reserved	Reserved	Reserved	Step Bit 4	Step Bit 3	Step Bit 2	Step Bit 1	Step Bit 0																																																																									
Default	0	0	0	0	0	0	0	0	0	0	0	0	0	0	0	0	0	0	0	0	0	0	0	0	0	0	0	0	0	0	0	0	0	0																																																																										
Bit	31	30	29	28	27	26	25	24	23	22	21	20	19	18	17	16	15	14	13	12	11	10	9	8	7	6	5	4	3	2	1	0																																																																												
		1212	<p><b>755 Units Traveled</b></p> <p>Units Traveled</p> <p>Indicates total number of units traveled. The relationship between the feedback edge counts and the position units is determined by the P1215 [Counts Per Unit]. Actual motor position is converted from the edge counts to this value using the P1215 [Counts Per Unit].</p>	<p>Units: Cnts</p> <p>Default: Read Only</p> <p>Min/Max: -/+ 2200000000.00</p>	RO	Real																																																																																																						

File	Group	No.	Display Name Full Name Description	Values	Read-Write	Data Type																																																																																																					
APPLICATIONS	Profiling	1213	<b>755 Profile Command</b> Profile Command Sets bits to configure the speed profile/position indexer control logic.  Options <table border="1"> <tr> <td></td> <td>Reserved</td><td>Reserved</td><td>Reserved</td><td>Reserved</td><td>Reserved</td><td>Reserved</td><td>Reserved</td><td>Reserved</td><td>Reserved</td><td>Reserved</td><td>Reserved</td><td>Reserved</td><td>Reserved</td><td>Reserved</td><td>Reserved</td><td>Reserved</td><td>Reserved</td><td>Reserved</td><td>Reserved</td><td>Reserved</td><td>Prof Run Alm</td><td>HomNotSetAlm</td><td>Restart Step</td><td>Vel Override</td><td>Hold Step</td><td>Reserved</td><td>Reserved</td><td>Reserved</td><td>StrStepSel4</td><td>StrStepSel3</td><td>StrStepSel2</td><td>StrStepSel1</td><td>StrStepSel0</td> </tr> <tr> <td>Default</td> <td>0</td><td>0</td><td>0</td><td>0</td><td>0</td><td>0</td><td>0</td><td>0</td><td>0</td><td>0</td><td>0</td><td>0</td><td>0</td><td>0</td><td>0</td><td>0</td><td>0</td><td>0</td><td>0</td><td>0</td><td>1</td><td>1</td><td>0</td><td>0</td><td>0</td><td>0</td><td>0</td><td>0</td><td>0</td><td>0</td><td>0</td><td>0</td><td>0</td> </tr> <tr> <td>Bit</td> <td>31</td><td>30</td><td>29</td><td>28</td><td>27</td><td>26</td><td>25</td><td>24</td><td>23</td><td>22</td><td>21</td><td>20</td><td>19</td><td>18</td><td>17</td><td>16</td><td>15</td><td>14</td><td>13</td><td>12</td><td>11</td><td>10</td><td>9</td><td>8</td><td>7</td><td>6</td><td>5</td><td>4</td><td>3</td><td>2</td><td>1</td><td>0</td> </tr> </table>		Reserved	Reserved	Reserved	Reserved	Reserved	Reserved	Reserved	Reserved	Reserved	Reserved	Reserved	Reserved	Reserved	Reserved	Reserved	Reserved	Reserved	Reserved	Reserved	Reserved	Prof Run Alm	HomNotSetAlm	Restart Step	Vel Override	Hold Step	Reserved	Reserved	Reserved	StrStepSel4	StrStepSel3	StrStepSel2	StrStepSel1	StrStepSel0	Default	0	0	0	0	0	0	0	0	0	0	0	0	0	0	0	0	0	0	0	0	1	1	0	0	0	0	0	0	0	0	0	0	0	Bit	31	30	29	28	27	26	25	24	23	22	21	20	19	18	17	16	15	14	13	12	11	10	9	8	7	6	5	4	3	2	1	0		RW	32-bit Integer
			Reserved	Reserved	Reserved	Reserved	Reserved	Reserved	Reserved	Reserved	Reserved	Reserved	Reserved	Reserved	Reserved	Reserved	Reserved	Reserved	Reserved	Reserved	Reserved	Reserved	Prof Run Alm	HomNotSetAlm	Restart Step	Vel Override	Hold Step	Reserved	Reserved	Reserved	StrStepSel4	StrStepSel3	StrStepSel2	StrStepSel1	StrStepSel0																																																																								
		Default	0	0	0	0	0	0	0	0	0	0	0	0	0	0	0	0	0	0	0	0	1	1	0	0	0	0	0	0	0	0	0	0	0																																																																								
Bit	31	30	29	28	27	26	25	24	23	22	21	20	19	18	17	16	15	14	13	12	11	10	9	8	7	6	5	4	3	2	1	0																																																																											
1215	<b>755 Counts Per Unit</b> Counts Per Unit Sets number of position feedback counts per unit of machine travel (for example 1024 encoder edge counts per inch). This parameter is used to scale position targets from their entered values of units to internal units of encoder edge counts. This parameter is also used to convert actual motor position from encoder edge counts back into the desired units for display in P1212 [Units Traveled].	Default: 1 Min/Max: 1 / 2200000000	RW	32-bit Integer																																																																																																							
1216	<b>755 ProfVel Override</b> Profile Velocity Override Sets multiplier for all move velocities when the velocity override function is selected P1213 [Profile Command] Bit 9 "Vel Override." This parameter is typically set to a value less than 1. When the velocity override bit P1213 [Profile Command] Bit 9 "Vel Override" is off, a scale factor of 1 is used.	Units: % Default: 100.00 Min/Max: 10.00 / 150.00	RW	Real																																																																																																							

File	Group	No.	Display Name Full Name Description	Values	Read-Write	Data Type																																																																																																			
APPLICATIONS	Profiling	1217	<b>755 Prof DI Invert</b>  Profile Digital Input Invert Sets polarity of the digital inputs. Each bit is assigned to a move table step. Rising edge of the digital input is used when the bit is off, and falling edge of digital input is used when the bit is on.  Options <table border="1" style="width: 100%; border-collapse: collapse; text-align: center;"> <thead> <tr> <th></th> <th>Reserved</th><th>Reserved</th><th>Reserved</th><th>Reserved</th><th>Reserved</th><th>Reserved</th><th>Reserved</th><th>Step 16</th><th>Step 15</th><th>Step 14</th><th>Step 13</th><th>Step 12</th><th>Step 11</th><th>Step 10</th><th>Step 9</th><th>Step 8</th><th>Step 7</th><th>Step 6</th><th>Step 5</th><th>Step 4</th><th>Step 3</th><th>Step 2</th><th>Step 1</th><th>StrStepSel4</th><th>StrStepSel3</th><th>StrStepSel2</th><th>StrStepSel1</th><th>StrStepSel0</th><th>Vel Override</th><th>AbortProfile</th><th>Abort Step</th><th>Hold Step</th> </tr> </thead> <tbody> <tr> <td>Default</td> <td>0</td><td>0</td><td>0</td><td>0</td><td>0</td><td>0</td><td>0</td><td>0</td><td>0</td><td>0</td><td>0</td><td>0</td><td>0</td><td>0</td><td>0</td><td>0</td><td>0</td><td>0</td><td>0</td><td>0</td><td>0</td><td>0</td><td>0</td><td>0</td><td>0</td><td>0</td><td>0</td><td>0</td><td>0</td><td>0</td><td>0</td><td>0</td> </tr> <tr> <td>Bit</td> <td>31</td><td>30</td><td>29</td><td>28</td><td>27</td><td>26</td><td>25</td><td>24</td><td>23</td><td>22</td><td>21</td><td>20</td><td>19</td><td>18</td><td>17</td><td>16</td><td>15</td><td>14</td><td>13</td><td>12</td><td>11</td><td>10</td><td>9</td><td>8</td><td>7</td><td>6</td><td>5</td><td>4</td><td>3</td><td>2</td><td>1</td><td>0</td> </tr> </tbody> </table>		Reserved	Reserved	Reserved	Reserved	Reserved	Reserved	Reserved	Step 16	Step 15	Step 14	Step 13	Step 12	Step 11	Step 10	Step 9	Step 8	Step 7	Step 6	Step 5	Step 4	Step 3	Step 2	Step 1	StrStepSel4	StrStepSel3	StrStepSel2	StrStepSel1	StrStepSel0	Vel Override	AbortProfile	Abort Step	Hold Step	Default	0	0	0	0	0	0	0	0	0	0	0	0	0	0	0	0	0	0	0	0	0	0	0	0	0	0	0	0	0	0	0	0	Bit	31	30	29	28	27	26	25	24	23	22	21	20	19	18	17	16	15	14	13	12	11	10	9	8	7	6	5	4	3	2	1	0		RW	32-bit Integer
			Reserved	Reserved	Reserved	Reserved	Reserved	Reserved	Reserved	Step 16	Step 15	Step 14	Step 13	Step 12	Step 11	Step 10	Step 9	Step 8	Step 7	Step 6	Step 5	Step 4	Step 3	Step 2	Step 1	StrStepSel4	StrStepSel3	StrStepSel2	StrStepSel1	StrStepSel0	Vel Override	AbortProfile	Abort Step	Hold Step																																																																							
		Default	0	0	0	0	0	0	0	0	0	0	0	0	0	0	0	0	0	0	0	0	0	0	0	0	0	0	0	0	0	0	0	0																																																																							
Bit	31	30	29	28	27	26	25	24	23	22	21	20	19	18	17	16	15	14	13	12	11	10	9	8	7	6	5	4	3	2	1	0																																																																									
				0 = Condition False 1 = Condition True																																																																																																					
		Bit 0 "Hold Step" – sets polarity of the digital input for the hold step, P1218 [DI Hold Step]. Bit 1 "Abort Step" – sets polarity of the digital input for abort step, P1219 [DI Abort Step]. Bit 2 "AbortProfile" – sets polarity of the digital input for abort profile, P1220 [DI Abort Profile]. Bit 3 "Vel Override" – sets polarity of the digital input for velocity override, P1221 [DI Vel Override]. Bit 4 "StrStepSel0" – sets polarity of the digital input for start step 1, P1222 [DI StrtStep Sel0]. Bit 5 "StrStepSel1" – sets polarity of the digital input for start step 2, P1223 [DI StrtStep Sel1]. Bit 6 "StrStepSel2" – sets polarity of the digital input for start step 3, P1224 [DI StrtStep Sel2]. Bit 7 "StrStepSel3" – sets polarity of the digital input for start step 4, P1225 [DI StrtStep Sel3]. Bit 8 "StrStepSel4" – sets polarity of the digital input for start step 5, P1226 [DI StrtStep Sel4]. Bit 9 "Step 1" – sets polarity of the digital input for move step 1, P1230 [Step 1 Type]. Bit 10 "Step 2" – sets polarity of the digital input for move step 2, P1240 [Step 2 Type]. Bit 11 "Step 3" – sets polarity of the digital input for move step 3, P1250 [Step 3 Type]. Bit 12 "Step 4" – sets polarity of the digital input for move step 4, P1260 [Step 4 Type]. Bit 13 "Step 5" – sets polarity of the digital input for move step 5, P1270 [Step 5 Type]. Bit 14 "Step 6" – sets polarity of the digital input for move step 6, P1280 [Step 6 Type]. Bit 15 "Step 7" – sets polarity of the digital input for move step 7, P1290 [Step 7 Type]. Bit 16 "Step 8" – sets polarity of the digital input for move step 8, P1300 [Step 8 Type]. Bit 17 "Step 9" – sets polarity of the digital input for move step 9, P1310 [Step 9 Type]. Bit 18 "Step 10" – sets polarity of the digital input for move step 10, P1320 [Step 10 Type]. Bit 19 "Step 11" – sets polarity of the digital input for move step 11, P1330 [Step 11 Type]. Bit 20 "Step 12" – sets polarity of the digital input for move step 12, P1340 [Step 12 Type]. Bit 21 "Step 13" – sets polarity of the digital input for move step 13, P1350 [Step 13 Type]. Bit 22 "Step 14" – sets polarity of the digital input for move step 14, P1360 [Step 14 Type]. Bit 23 "Step 15" – sets polarity of the digital input for move step 15, P1370 [Step 15 Type]. Bit 24 "Step 16" – sets polarity of the digital input for move step 16, P1380 [Step 16 Type].																																																																																																							
		1218	<b>755 DI Hold Step</b>  Digital Input Hold Step  Sets a digital input port for the hold step in profile/indexer control logic. The digital input assigned by this parameter is equivalent to P1213 [Profile Command] Bit 8 "Hold Step." Polarity of active state is defined by P1217 [Prof DI Invert] Bit 0 "Hold Step."	Default: 0.00 Min/Max: 0.00 / 159999.15	RW	32-bit Integer																																																																																																			
		1219	<b>755 DI Abort Step</b>  Digital Input Abort Step  Sets a digital input port for the abort step in profile/indexer control logic. Polarity of active state is defined by P1217 [Prof DI Invert] Bit 1 "Abort Step."	Default: 0.00 Min/Max: 0.00 / 159999.15	RW	32-bit Integer																																																																																																			

File	Group	No.	Display Name Full Name Description	Values	Read-Write	Data Type	
APPLICATIONS	Profiling	1220	 <b>755 DI Abort Profile</b> Digital Input Abort Profile Sets a digital input port for the abort profile in profile/indexer control logic. Polarity of active state is defined by P1217 [Prof DI Invert] Bit 2 "AbortProfile."	Default: 0.00 Min/Max: 0.00 / 159999.15	RW	32-bit Integer	
		1221	 <b>755 DI Vel Override</b> Digital Input Velocity Profile Sets a digital input port for the velocity override in profile/indexer control logic. The digital input assigned by this parameter is equivalent to P1213 [Profile Command] Bit 9 "Vel Override." Polarity of active state is defined by P1217 [Prof DI Invert] Bit 3 "Vel Override."	Default: 0.00 Min/Max: 0.00 / 159999.15	RW	32-bit Integer	
		1222	<b>755 DI StrtStep Sel0</b>	Default: 0.00 Min/Max: 0.00 / 159999.15	RW	32-bit Integer	
		1223	<b>755 DI StrtStep Sel1</b>				
		1224	<b>755 DI StrtStep Sel2</b>				
		1225	<b>755 DI StrtStep Sel3</b>				
		1226	<b>755 DI StrtStep Sel4</b>				
			 Digital Input Start Step Select <i>n</i> Set digital input ports for the start step in profile/indexer control logic. The digital inputs assigned by these parameters are equivalent to P1213 [Profile Command] Bit 4 "StrtStepSel4." Polarities of active state are defined by P1217 [Prof DI Invert] Bit 4 "StrtStepSel0" to Bit 8 "StrtStepSel4."				
		1230	<b>755 Step 1 Type</b>	Default: 0 = "Speed" Options: 0 = "Speed" 1 = "Position Abs" 2 = "PositionIncr"	RW	32-bit Integer	
		1240	<b>755 Step 2 Type</b>				
		1250	<b>755 Step 3 Type</b>				
		1260	<b>755 Step 4 Type</b>				
		1270	<b>755 Step 5 Type</b>				
		1280	<b>755 Step 6 Type</b>				
		1290	<b>755 Step 7 Type</b>				
		1300	<b>755 Step 8 Type</b>				
		1310	<b>755 Step 9 Type</b>				
		1320	<b>755 Step 10 Type</b>				
		1330	<b>755 Step 11 Type</b>				
1340	<b>755 Step 12 Type</b>						
1350	<b>755 Step 13 Type</b>						
1360	<b>755 Step 14 Type</b>						
1370	<b>755 Step 15 Type</b>						
1380	<b>755 Step 16 Type</b>						
	 Step <i>n</i> Type Set type of move for a particular step. The possible step types are: "Speed" (0) = Speed Profile moves in speed mode. "Position Abs" (1) = Position Absolute moves in absolute position mode. "PositionIncr" (2) = Position Incremental moves in position increment mode. The drive must have the direction mode set to the bipolar for the position regulator to function properly. The current, torque, and regen power limits must be set so as not to limit the programmed deceleration time. If the limits occur, the position regulator may overshoot the position set point.						

File	Group	No.	Display Name Full Name Description	Values	Read-Write	Data Type
APPLICATIONS	Profiling	1231	<b>755 Step 1 Velocity</b>	Units: Hz / RPM Default: 0.00 Min/Max: -/+P27 [Motor NP Hertz] x 8 -/+P28 [Motor NP RPM] x 8	RW	Real
		1241	<b>755 Step 2 Velocity</b>			
		1251	<b>755 Step 3 Velocity</b>			
		1261	<b>755 Step 4 Velocity</b>			
		1271	<b>755 Step 5 Velocity</b>			
		1281	<b>755 Step 6 Velocity</b>			
		1291	<b>755 Step 7 Velocity</b>			
		1301	<b>755 Step 8 Velocity</b>			
		1311	<b>755 Step 9 Velocity</b>			
		1321	<b>755 Step 10 Velocity</b>			
		1331	<b>755 Step 11 Velocity</b>			
		1341	<b>755 Step 12 Velocity</b>			
		1351	<b>755 Step 13 Velocity</b>			
		1361	<b>755 Step 14 Velocity</b>			
		1371	<b>755 Step 15 Velocity</b>			
		1381	<b>755 Step 16 Velocity</b>			
			Step <i>n</i> Velocity Set speed at which a move will take place. The step velocity applies to all three types of moves – position absolute, position incremental, and speed profile. The motor may not achieve the step velocity in all cases. Short distance moves may begin to decelerate before the step velocity is reached. If the move is sufficiently long, then the motor speed will be limited to the step velocity. Sign on the step velocity is used to determine direction of motor rotation. Cannot be used with most blended moves in Position Absolute type and Position Incremental type.			
		1232	<b>755 Step 1 Accel</b>	Units: Secs Default: 10.00 Min/Max: 0.00 / 3600.00	RW	Real
		1242	<b>755 Step 2 Accel</b>			
		1252	<b>755 Step 3 Accel</b>			
		1262	<b>755 Step 4 Accel</b>			
		1272	<b>755 Step 5 Accel</b>			
		1282	<b>755 Step 6 Accel</b>			
		1292	<b>755 Step 7 Accel</b>			
		1302	<b>755 Step 8 Accel</b>			
		1312	<b>755 Step 9 Accel</b>			
		1322	<b>755 Step 10 Accel</b>			
		1332	<b>755 Step 11 Accel</b>			
1342	<b>755 Step 12 Accel</b>					
1352	<b>755 Step 13 Accel</b>					
1362	<b>755 Step 14 Accel</b>					
1372	<b>755 Step 15 Accel</b>					
1382	<b>755 Step 16 Accel</b>					
	Step <i>n</i> Acceleration Set acceleration time between zero and rated motor speed in seconds. The motor will accelerate towards the step speed using the step velocity parameter. The minimum acceleration rate is determined by the system inertia. Cannot be used with most blended moves in Position Absolute type and Position Incremental type.					


















File	Group	No.	Display Name Full Name Description	Values		Read-Write	Data Type
APPLICATIONS	Profiling	1233	755 Step 1 Decel	Units: Secs Default: 10.00 Min/Max: 0.00 / 3600.00		RW	Real
		1243	755 Step 2 Decel				
		1253	755 Step 3 Decel				
		1263	755 Step 4 Decel				
		1273	755 Step 5 Decel				
		1283	755 Step 6 Decel				
		1293	755 Step 7 Decel				
		1303	755 Step 8 Decel				
		1313	755 Step 9 Decel				
		1323	755 Step 10 Decel				
		1333	755 Step 11 Decel				
		1343	755 Step 12 Decel				
		1353	755 Step 13 Decel				
		1363	755 Step 14 Decel				
		1373	755 Step 15 Decel				
		1383	755 Step 16 Decel				
		<p>Step <i>n</i> Deceleration</p> <p>Set deceleration time between rated motor speed and zero in seconds. The motor will decelerate towards zero speed. The minimum deceleration rate is determined by the system inertia.</p> <p>Cannot be used with most blended moves in Position Absolute type and Position Incremental type.</p>					






File	Group	No.	Display Name Full Name Description	Values	Read-Write	Data Type
APPLICATIONS	Profiling	1234	<b>755 Step 1 Value</b>	Default: 0 Min/Max: -2147483648 / 2147483647	RW	32-bit Integer
		1244	<b>755 Step 2 Value</b>			
		1254	<b>755 Step 3 Value</b>			
		1264	<b>755 Step 4 Value</b>			
		1274	<b>755 Step 5 Value</b>			
		1284	<b>755 Step 6 Value</b>			
		1294	<b>755 Step 7 Value</b>			
		1304	<b>755 Step 8 Value</b>			
		1314	<b>755 Step 9 Value</b>			
		1324	<b>755 Step 10 Value</b>			
		1334	<b>755 Step 11 Value</b>			
		1344	<b>755 Step 12 Value</b>			
		1354	<b>755 Step 13 Value</b>			
		1364	<b>755 Step 14 Value</b>			
		1374	<b>755 Step 15 Value</b>			
		1384	<b>755 Step 16 Value</b>			

File	Group	No.	Display Name Full Name Description	Values	Read-Write	Data Type
APPLICATIONS	Profiling	1235	<b>755 Step 1 Dwell</b>	Units: Secs Default: 0.00 Min/Max: -1.00 / 3600.00	RW	Real
		1245	<b>755 Step 2 Dwell</b>			
		1255	<b>755 Step 3 Dwell</b>			
		1265	<b>755 Step 4 Dwell</b>			
		1275	<b>755 Step 5 Dwell</b>			
		1285	<b>755 Step 6 Dwell</b>			
		1295	<b>755 Step 7 Dwell</b>			
		1305	<b>755 Step 8 Dwell</b>			
		1315	<b>755 Step 9 Dwell</b>			
		1325	<b>755 Step 10 Dwell</b>			
		1335	<b>755 Step 11 Dwell</b>			
		1345	<b>755 Step 12 Dwell</b>			
		1355	<b>755 Step 13 Dwell</b>			
		1365	<b>755 Step 14 Dwell</b>			
		1375	<b>755 Step 15 Dwell</b>			
		1385	<b>755 Step 16 Dwell</b>			
			Step <i>n</i> Dwell Set time delay between moves. P1210 [Profile Status] Bit 11 "Dwell" will be set to indicate that the step dwell period is active and timing. Zero value will disable dwell, negative value will wait forever. Not all steps can use dwell (example, most blended moves cannot use dwell). When the speed type with the parameter blend action move is used, the step dwell parameter will contain the parameter number of the set-point value to compare with the parameter selected in the value parameter.			
		1236	<b>755 Step 1 Batch</b>	Default: 1 Min/Max: 0 / 65535	RW	32-bit Integer
		1246	<b>755 Step 2 Batch</b>			
		1256	<b>755 Step 3 Batch</b>			
		1266	<b>755 Step 4 Batch</b>			
		1276	<b>755 Step 5 Batch</b>			
		1286	<b>755 Step 6 Batch</b>			
		1296	<b>755 Step 7 Batch</b>			
		1306	<b>755 Step 8 Batch</b>			
		1316	<b>755 Step 9 Batch</b>			
		1326	<b>755 Step 10 Batch</b>			
		1336	<b>755 Step 11 Batch</b>			
1346	<b>755 Step 12 Batch</b>					
1356	<b>755 Step 13 Batch</b>					
1366	<b>755 Step 14 Batch</b>					
1376	<b>755 Step 15 Batch</b>					
1386	<b>755 Step 16 Batch</b>					
	Step <i>n</i> Batch Set number of times to repeat a step. For example, a batch count of two will cause that step to repeat two times before starting the next step. These parameters cannot be used with position absolute moves, since this would imply moving to the same position repeatedly. These parameters cannot be used with most blended moves (exception dig-in blend), because most blended moves need to transition to the next step, instead of repeating. The dig-in blend moves use this parameter to specify the number of digital input transitions required. A zero step batch setting will cause that step to repeat forever.					

File	Group	No.	Display Name Full Name Description	Values	Read-Write	Data Type	
APPLICATIONS	Profiling	1237	<b>755 Step 1 Next</b>	Default: 2 Min/Max: 1 / 16	RW	32-bit Integer	
		1247	<b>755 Step 2 Next</b>				
		1257	<b>755 Step 3 Next</b>				
		1267	<b>755 Step 4 Next</b>				
		1277	<b>755 Step 5 Next</b>				
		1287	<b>755 Step 6 Next</b>				
		1297	<b>755 Step 7 Next</b>				
		1307	<b>755 Step 8 Next</b>				
		1317	<b>755 Step 9 Next</b>				
		1327	<b>755 Step 10 Next</b>				
		1337	<b>755 Step 11 Next</b>				
		1347	<b>755 Step 12 Next</b>				
		1357	<b>755 Step 13 Next</b>				
		1367	<b>755 Step 14 Next</b>				
		1377	<b>755 Step 15 Next</b>				
		1387	<b>755 Step 16 Next</b>				
	<p>Step <i>n</i> Next</p> <p>Set step number that will be executed after the current step is complete. The current step will be complete after any batch repeat cycles have finished. Typically, steps are executed in ascending order, although this is not a requirement. These parameters do not apply to a step having an End action, since this step is normally used to terminate a sequence of step moves.</p>						
			1238	<b>755 Step 1 Action</b>	Default: 1 = "Step to Next" Options: 0 = "End" 1 = "Step to Next" 2 = "Psn Blend" 3 = "Time Blend" 4 = "Param Blend" 5 = "DigIn Blend" 6 = "Wait DigIn"	RW	32-bit Integer
			1248	<b>755 Step 2 Action</b>			
			1258	<b>755 Step 3 Action</b>			
			1268	<b>755 Step 4 Action</b>			
			1278	<b>755 Step 5 Action</b>			
			1288	<b>755 Step 6 Action</b>			
			1298	<b>755 Step 7 Action</b>			
			1308	<b>755 Step 8 Action</b>			
			1318	<b>755 Step 9 Action</b>			
			1328	<b>755 Step 10 Action</b>			
		1338	<b>755 Step 11 Action</b>				
		1348	<b>755 Step 12 Action</b>				
		1358	<b>755 Step 13 Action</b>				
		1368	<b>755 Step 14 Action</b>				
		1378	<b>755 Step 15 Action</b>				
		1388	<b>755 Step 16 Action</b>				
<p>Step <i>n</i> Action</p> <p>Set what is to be done at the end of a step after the move is complete.</p> <p>End (0) = End stops the move sequence.</p> <p>Step to Next (1) = Step to Next moves to the next step after the speed ramp up/down is completed in the specific total time. The dwell time and the batch can be applied.</p> <p>Psn Blend (2) = Posit Blend moves to the next step after the actual position becomes greater than the position specified in the value parameter.</p> <p>Time Blend (3) = Time Blend moves to the next step after the total running time becomes greater than the time specified in the value parameter.</p> <p>Param Blend (4) = Param Blend moves to the next step after comparison of two parameters is satisfied. The parameters for comparison are specified in the value and dwell parameter.</p> <p>DigIn Blend (5) = DigIn Blend moves to the next step after the specified number of digital input rising (or falling) edges are applied. The batch parameter specifies the number of digital input edges.</p> <p>Wait DigIn (6) = Wait DigIn moves to the next step after the digital input rising (or falling) edges are applied.</p>							

File	Group	No.	Display Name Full Name Description	Values	Read-Write	Data Type
APPLICATIONS	Profiling	1239	 Step 1 Dig In	Default: 0.00 Min/Max: 0.00 / 159999.15	RW	32-bit Integer
		1249	 Step 2 Dig In			
		1259	 Step 3 Dig In			
		1269	 Step 4 Dig In			
		1279	 Step 5 Dig In			
		1289	 Step 6 Dig In			
		1299	 Step 7 Dig In			
		1309	 Step 8 Dig In			
		1319	 Step 9 Dig In			
		1329	 Step 10 Dig In			
		1339	 Step 11 Dig In			
		1349	 Step 12 Dig In			
		1359	 Step 13 Dig In			
		1369	 Step 14 Dig In			
		1379	 Step 15 Dig In			
		1389	 Step 16 Dig In			
						



File	Group	No.	Display Name Full Name Description	Values	Read-Write	Data Type																																																			
APPLICATIONS	Camming	1390	<b>755 PCAM Control</b> Position Camming Control Sets bits to control the position CAM control logic.  Options <table border="1" style="margin-left: 20px;"> <thead> <tr> <th></th> <th>Reserved</th> <th>Reserved</th> <th>Reserved</th> <th>Reserved</th> <th>Reserved</th> <th>Reserved</th> <th>Reserved</th> <th>Cndtnl Hold</th> <th>Unidirection</th> <th>Reref Psn In</th> <th>Offset En</th> <th>Alt Slope</th> <th>Aux Cam En</th> <th>ReverseY Out</th> <th>ReverseX In</th> <th>Start</th> </tr> </thead> <tbody> <tr> <td>Default</td> <td>0</td> <td>0</td> <td>0</td> <td>0</td> <td>0</td> <td>0</td> <td>0</td> <td>0</td> <td>0</td> <td>0</td> <td>0</td> <td>0</td> <td>0</td> <td>0</td> <td>0</td> <td>0</td> </tr> <tr> <td>Bit</td> <td>15</td> <td>14</td> <td>13</td> <td>12</td> <td>11</td> <td>10</td> <td>9</td> <td>8</td> <td>7</td> <td>6</td> <td>5</td> <td>4</td> <td>3</td> <td>2</td> <td>1</td> <td>0</td> </tr> </tbody> </table> 0 = Disabled 1 = Enabled  Bit 0 "Start" – Start the position CAM Bit 1 "ReverseX In" – Reverse polarity of x-axis input (P1392 [PCAM Psn Select]) Bit 2 "ReverseY Out" – Reverse polarity of y-axis output at beginning of next cycle (P1473 [PCAM Psn Out]) Bit 3 "Aux Cam En" – Switch to the auxiliary CAM profile at beginning of next cycle Bit 4 "Alt Slope" – Use a different slope calculation Bit 5 "Offset En" – Enable input offset function (P1394 [PCAM Psn Ofst]) Bit 6 "Reref Psn In" – Permit re-referencing x-axis input (P1392 [PCAM Psn Select]) Bit 7 "Unidirection" – Use unidirectional operation Bit 8 "Cndtnl Hold" – Freeze the speed regulator's integrator if position reference changes. This bit is recommended to be set for point to point motion.		Reserved	Reserved	Reserved	Reserved	Reserved	Reserved	Reserved	Cndtnl Hold	Unidirection	Reref Psn In	Offset En	Alt Slope	Aux Cam En	ReverseY Out	ReverseX In	Start	Default	0	0	0	0	0	0	0	0	0	0	0	0	0	0	0	0	Bit	15	14	13	12	11	10	9	8	7	6	5	4	3	2	1	0		RW	16-bit Integer
			Reserved	Reserved	Reserved	Reserved	Reserved	Reserved	Reserved	Cndtnl Hold	Unidirection	Reref Psn In	Offset En	Alt Slope	Aux Cam En	ReverseY Out	ReverseX In	Start																																							
		Default	0	0	0	0	0	0	0	0	0	0	0	0	0	0	0	0																																							
		Bit	15	14	13	12	11	10	9	8	7	6	5	4	3	2	1	0																																							
		1391	<b>755 PCAM Mode</b> Position Camming Mode The parameter sets type of operational mode. "Off" (0) – Disable position CAM function "Single Step" (1) – At rising edge of Start (P1390 [PCAM Control]), the CAM profile begins at point 0 and runs until the x-axis has reached the last point defined by the end point (P1405 [PCAM Main EndPnt] and P1439 [PCAM Aux EndPnt]) at which point it is completed. If the x-axis then backs up into CAM range, nothing happens; the profile has already completed and won't restart until control Start (P1390 [PCAM Control]) is once again set. "Continuous" (2) – At rising edge of Start (P1390 [PCAM Control]), the CAM profile begins at point 0 and runs to the end point (P1405 [PCAM Main EndPnt] and P1439 [PCAM Aux EndPnt]), and then repeats forever or until the control bit Start (P1390 [PCAM Control]) is cleared. "Persistent" (3) – At rising edge of Start (P1390 [PCAM Control]), the CAM profile begins at point 0 and runs to the end point (P1405 [PCAM Main EndPnt] and P1439 [PCAM Aux EndPnt]), and remains active until the control bit Start (P1390 [PCAM Control]) is cleared.	Default: 0 = "Off" Options: 0 = "Off" 1 = "Single Step" 2 = "Continuous" 3 = "Persistent"	RW	32-bit Integer																																																			
1392	<b>755 PCAM Psn Select</b>  Position Camming Position Select The parameter selects a position reference source for x-axis.	Default: 1393 Options: 1 / 159999	RW	32-bit Integer																																																					
1393	<b>755 PCAM Psn Stpt</b> Position Camming Position Setpoint The parameter provides position reference for x-axis when the position reference select (P1392 [PCAM Psn Select]) selects this parameter.	Default: 0 Min/Max: -2147483648 / 2147483647	RW	32-bit Integer																																																					
1394	<b>755 PCAM Psn Ofst</b> Position Camming Position Offset The parameter provides position offset value to x-axis position when the offset enable control bit (P1390 [PCAM Control]) is set. The offset value causes a phase shift or position change in x-axis and a momentary change to CAM speed.	Default: 0 Min/Max: -2147483648 / 2147483647	RW	32-bit Integer																																																					



File	Group	No.	Display Name Full Name Description	Values		Read-Write	Data Type
APPLICATIONS	Camming	1395	<b>755 PCAM PsnOfst Eps</b> Position Camming Position Offset Eps The parameter provides count of edges per second for virtual encoder function. The value makes a limit on change of x-axis position in change of position offset input.	Default: 2000 Min/Max: 0 / 2147483647		RW	32-bit Integer
		1396	<b>755 PCAM Span X</b> Position Camming Span X Axis The parameter provides the number of integer counts equivalent to the span or range of x-axis.	Default: 8192 Min/Max: 0 / 2147483647		RW	32-bit Integer
		1397	<b>755 PCAM Scale X</b> Position Camming Scale X Axis The parameter multiplies span x (P1396 [PCAM Span X]) such that the x-axis dimension will expand if this parameter is greater than 1.	Default: 1.00 Min/Max: 0.01 / 214748000.00		RW	Real
		1398	<b>755 PCAM Span Y</b> Position Camming Span Y Axis The parameter provides the number of edges equivalent to the span of the y-axis. The value is the number of integer counts representing the maximum vertical extent of the profile.	Default: 8192 Min/Max: 0 / 2147483647		RW	32-bit Integer
		1399	<b>755 PCAM ScaleY Sel</b>  Position Camming Scale Y Axis Select The parameter selects a source for y-axis scale.	Default: 1400 Options: 1 / 159999		RW	32-bit Integer
		1400	<b>755 PCAM ScaleYSetPt</b> Position Camming Scale Y Axis Setpoint The parameter provides y-axis scale when the y scale select (P1399 [PCAM ScaleY Sel]) selects this parameter. The y scale multiplies the y span such that the y-axis dimension will increase if y scale is greater than 1.	Default: 1.00 Min/Max: 0.00 / 214748000.00		RW	Real
		1401	<b>755 PCAM VelScaleSel</b>  Position Camming Velocity Scale Select The parameter selects a source for velocity scale.	Default: 1402 Options: 1 / 159999		RW	32-bit Integer
		1402	<b>755 PCAM VelScaleSP</b> Position Camming Velocity Scale Setpoint The parameter provides velocity scale when the velocity scale select (P1401 [PCAM VelScaleSel]) selects this parameter. The velocity scale multiplies the velocity output (P1472 [PCAM Vel Out]) such that the velocity output (P1472) will decrease if the velocity scale is less than 1.	Units: MPE Default: 0.000100 Min/Max: 0.000000 / 8.000000		RW	Real
		1403	<b>755 PCAM Slope Begin</b> Position Camming Slope Begin The parameter provides beginning slope at CAM point 0. The parameter is used only if the segment is cubic type curve.	Default: 0.00 Min/Max: -/+214748000.00		RW	Real
		1404	<b>755 PCAM Slope End</b> Position Camming Slope End The parameter provides ending slope at CAM point 0. The parameter is used only if the segment is cubic type curve in both the main and the auxiliary CAM profile.	Default: 0.00 Min/Max: -/+214748000.00		RW	Real
		1405	<b>755 PCAM Main EndPnt</b> Position Camming Main End Point The parameter provides a number of the last CAM point used in the main CAM profile.	Default: 0 Options: 0 / 15		RW	32-bit Integer

File	Group	No.	Display Name Full Name Description	Values	Read-Write	Data Type																												
APPLICATIONS	Camming	1406	<b>755 PCAM Main Types</b> Position Camming Main Types  Each bit sets curve type for each segment in the main CAM profile. If the bit is clear, the curve is linear at the point of segment in the main CAM profile. If the bit is set, the curve is cubic at the point of segment in the main CAM profile.  Options		RW	32-bit Integer																												
			Reserved	Reserved	Reserved	Reserved	Reserved	Reserved	Reserved	Reserved	Reserved	Reserved	Reserved	Reserved	Reserved	Reserved	Reserved	CubicCurve15	CubicCurve14	CubicCurve13	CubicCurve12	CubicCurve11	CubicCurve10	CubicCurve9	CubicCurve8	CubicCurve7	CubicCurve6	CubicCurve5	CubicCurve4	CubicCurve3	CubicCurve2	CubicCurve1	CubicCurve0	
		Default	0	0	0	0	0	0	0	0	0	0	0	0	0	0	0	0	0	0	0	0	0	0	0	0	0	0	0	0	0	0	0	
		Bit	31	30	29	28	27	26	25	24	23	22	21	20	19	18	17	16	15	14	13	12	11	10	9	8	7	6	5	4	3	2	1	0
			0 = Disabled 1 = Enabled																															
		1407	<b>755 PCAM Main Pt X 0</b>	Default:	0.00	RW	Real																											
		1409	<b>755 PCAM Main Pt X 1</b>	Min/Max:	-/+220000000.00																													
		1411	<b>755 PCAM Main Pt X 2</b>																															
		1413	<b>755 PCAM Main Pt X 3</b>																															
		1415	<b>755 PCAM Main Pt X 4</b>																															
1417	<b>755 PCAM Main Pt X 5</b>																																	
1419	<b>755 PCAM Main Pt X 6</b>																																	
1421	<b>755 PCAM Main Pt X 7</b>																																	
1423	<b>755 PCAM Main Pt X 8</b>																																	
1425	<b>755 PCAM Main Pt X 9</b>																																	
1427	<b>755 PCAM Main PtX 10</b>																																	
1429	<b>755 PCAM Main PtX 11</b>																																	
1431	<b>755 PCAM Main PtX 12</b>																																	
1433	<b>755 PCAM Main PtX 13</b>																																	
1435	<b>755 PCAM Main PtX 14</b>																																	
1437	<b>755 PCAM Main PtX 15</b>																																	
		Position Camming Main Point X n Provides x-coordinate value for CAM point in the main CAM profile.																																
1408	<b>755 PCAM Main Pt Y 0</b>	Default:	0.00	RW	Real																													
1410	<b>755 PCAM Main Pt Y 1</b>	Min/Max:	-/+220000000.00																															
1412	<b>755 PCAM Main Pt Y 2</b>																																	
1414	<b>755 PCAM Main Pt Y 3</b>																																	
1416	<b>755 PCAM Main Pt Y 4</b>																																	
1418	<b>755 PCAM Main Pt Y 5</b>																																	
1420	<b>755 PCAM Main Pt Y 6</b>																																	
1422	<b>755 PCAM Main Pt Y 7</b>																																	
1424	<b>755 PCAM Main Pt Y 8</b>																																	
1426	<b>755 PCAM Main Pt Y 9</b>																																	
1428	<b>755 PCAM Main PtY 10</b>																																	
1430	<b>755 PCAM Main PtY 11</b>																																	
1432	<b>755 PCAM Main PtY 12</b>																																	
1434	<b>755 PCAM Main PtY 13</b>																																	
1436	<b>755 PCAM Main PtY 14</b>																																	
1438	<b>755 PCAM Main PtY 15</b>																																	
		Position Camming Main Point Y n Provides y-coordinate value for CAM point in the main CAM profile.																																

File	Group	No.	Display Name Full Name Description	Values	Read-Write	Data Type
APPLICATIONS	Camming	1439	<b>755 PCAM Aux EndPnt</b> Position Camming Auxiliary End Point Provides a number of the last CAM point used in the auxiliary CAM profile.	Default: 1 Options: 1 / 15	RW	32-bit Integer
		1440	<b>755 PCAM Aux Types</b> Position Camming Auxiliary Types Each bit sets curve type for each segment in the auxiliary CAM profile. If the bit is clear, the curve is linear at the point of segment in the auxiliary CAM profile. If the bit is set, the curve is cubic at the point of segment in the auxiliary CAM profile.  Options Reserved Reserved Reserved Reserved Reserved Reserved Reserved Reserved Reserved Reserved Reserved Reserved Reserved Reserved Reserved Reserved CubicCurve15 CubicCurve14 CubicCurve13 CubicCurve12 CubicCurve11 CubicCurve10 CubicCurve9 CubicCurve8 CubicCurve7 CubicCurve6 CubicCurve5 CubicCurve4 CubicCurve3 CubicCurve2 CubicCurve1 Reserved Default 0 Bit 31 30 29 28 27 26 25 24 23 22 21 20 19 18 17 16 15 14 13 12 11 10 9 8 7 6 5 4 3 2 1 0  0 = Disabled 1 = Enabled		RW	32-bit Integer
		1441	<b>755 PCAM Aux Pt X 1</b>	Default: 0.00	RW	Real
		1443	<b>755 PCAM Aux Pt X 2</b>	Min/Max: -/+220000000.00		
		1445	<b>755 PCAM Aux Pt X 3</b>			
		1447	<b>755 PCAM Aux Pt X 4</b>			
		1449	<b>755 PCAM Aux Pt X 5</b>			
		1451	<b>755 PCAM Aux Pt X 6</b>			
		1453	<b>755 PCAM Aux Pt X 7</b>			
		1455	<b>755 PCAM Aux Pt X 8</b>			
		1457	<b>755 PCAM Aux Pt X 9</b>			
		1459	<b>755 PCAM Aux PtX 10</b>			
		1461	<b>755 PCAM Aux PtX 11</b>			
		1463	<b>755 PCAM Aux PtX 12</b>			
		1465	<b>755 PCAM Aux PtX 13</b>			
1467	<b>755 PCAM Aux PtX 14</b>					
1469	<b>755 PCAM Aux PtX 15</b>					
		Position Camming Auxiliary Point X <i>n</i> Provides x-coordinate value for CAM point in the auxiliary CAM profile.				
1442	<b>755 PCAM Aux Pt Y 1</b>	Default: 0.00	RW	Real		
1444	<b>755 PCAM Aux Pt Y 2</b>	Min/Max: -/+220000000.00				
1446	<b>755 PCAM Aux Pt Y 3</b>					
1448	<b>755 PCAM Aux Pt Y 4</b>					
1450	<b>755 PCAM Aux Pt Y 5</b>					
1452	<b>755 PCAM Aux Pt Y 6</b>					
1454	<b>755 PCAM Aux Pt Y 7</b>					
1456	<b>755 PCAM Aux Pt Y 8</b>					
1458	<b>755 PCAM Aux Pt Y 9</b>					
1460	<b>755 PCAM Aux PtY 10</b>					
1462	<b>755 PCAM Aux PtY 11</b>					
1464	<b>755 PCAM Aux PtY 12</b>					
1466	<b>755 PCAM Aux PtY 13</b>					
1468	<b>755 PCAM Aux PtY 14</b>					
1470	<b>755 PCAM Aux PtY 15</b>					
		Position Camming Auxiliary Point Y <i>n</i> Provides y-coordinate value for CAM point in the auxiliary CAM profile.				




File	Group	No.	Display Name Full Name Description	Values	Read-Write	Data Type																																																																																															
APPLICATIONS	Camming	1471	<b>755 PCAM Status</b> Position Camming Status Indicates status of position CAM logic.  Options <table border="1"> <tr> <td>Reserved</td><td>Reserved</td><td>Reserved</td><td>Reserved</td><td>Reserved</td><td>Reserved</td><td>Reserved</td><td>Reserved</td><td>Reserved</td><td>Reserved</td><td>Reserved</td><td>Reserved</td><td>Reserved</td><td>Reserved</td><td>Reserved</td><td>Reserved</td><td>Reserved</td><td>Reserved</td><td>Cndtnl Hold</td><td>Unidirection</td><td>Reref Psn In</td><td>Offset En</td><td>Alt Slope</td><td>Aux Cam En</td><td>ReverseY Out</td><td>ReverseX In</td><td>Start</td><td>In Cam</td><td>Persist Mode</td><td>Contins Mode</td><td>Single Mode</td> </tr> <tr> <td>0</td><td>0</td><td>0</td><td>0</td><td>0</td><td>0</td><td>0</td><td>0</td><td>0</td><td>0</td><td>0</td><td>0</td><td>0</td><td>0</td><td>0</td><td>0</td><td>0</td><td>0</td><td>0</td><td>0</td><td>0</td><td>0</td><td>0</td><td>0</td><td>0</td><td>0</td><td>0</td><td>0</td><td>0</td><td>0</td><td>0</td> </tr> <tr> <td>Bit</td><td>31</td><td>30</td><td>29</td><td>28</td><td>27</td><td>26</td><td>25</td><td>24</td><td>23</td><td>22</td><td>21</td><td>20</td><td>19</td><td>18</td><td>17</td><td>16</td><td>15</td><td>14</td><td>13</td><td>12</td><td>11</td><td>10</td><td>9</td><td>8</td><td>7</td><td>6</td><td>5</td><td>4</td><td>3</td><td>2</td><td>1</td><td>0</td> </tr> </table> <p style="text-align: right;">0 = Disabled 1 = Enabled</p> Bit 0 "Single Mode" – Position CAM is in single step mode. Bit 1 "Contins Mode" – Position CAM is in continuous mode. Bit 2 "Persist Mode" – Position CAM is in persistent mode. Bit 3 "In Cam" – X-axis is in range of defined profile. Bit 4 "Start" – Position CAM has started. Bit 5 "ReverseX In" – X-axis input is reversed. Bit 6 "ReverseY Out" – Y-axis output is reversed. Bit 7 "Aux Cam En" – Auxiliary CAM profile is in use. Bit 8 "Alt Slope" – Alternated slope is in use. Bit 9 "Offset En" – X-axis offset is enabled. Bit 10 "Reref Pos In" – X-position input is re-referencing. Bit 11 "Unidirection" – Position CAM is in unidirectional mode. Bit 12 "Cndtnl Hold" – Conditional integrator hold is in use.	Reserved	Reserved	Reserved	Reserved	Reserved	Reserved	Reserved	Reserved	Reserved	Reserved	Reserved	Reserved	Reserved	Reserved	Reserved	Reserved	Reserved	Reserved	Cndtnl Hold	Unidirection	Reref Psn In	Offset En	Alt Slope	Aux Cam En	ReverseY Out	ReverseX In	Start	In Cam	Persist Mode	Contins Mode	Single Mode	0	0	0	0	0	0	0	0	0	0	0	0	0	0	0	0	0	0	0	0	0	0	0	0	0	0	0	0	0	0	0	Bit	31	30	29	28	27	26	25	24	23	22	21	20	19	18	17	16	15	14	13	12	11	10	9	8	7	6	5	4	3	2	1	0		RO	32-bit Integer
		Reserved	Reserved	Reserved	Reserved	Reserved	Reserved	Reserved	Reserved	Reserved	Reserved	Reserved	Reserved	Reserved	Reserved	Reserved	Reserved	Reserved	Reserved	Cndtnl Hold	Unidirection	Reref Psn In	Offset En	Alt Slope	Aux Cam En	ReverseY Out	ReverseX In	Start	In Cam	Persist Mode	Contins Mode	Single Mode																																																																					
		0	0	0	0	0	0	0	0	0	0	0	0	0	0	0	0	0	0	0	0	0	0	0	0	0	0	0	0	0	0	0																																																																					
		Bit	31	30	29	28	27	26	25	24	23	22	21	20	19	18	17	16	15	14	13	12	11	10	9	8	7	6	5	4	3	2	1	0																																																																			
1472	<b>755 PCAM Vel Out</b> Position Camming Velocity Output Indicates output velocity in per unit. The value is connected to the speed regulator.	Units: Hz RPM Default: 0.00 Min/Max: 0.00 / P27 [Motor NP Hertz] x 8 0.00 / P28 [Motor NP RPM] x 8	RO	Real																																																																																																	
1473	<b>755 PCAM Psn Out</b> Position Camming Position Output Indicates output position. The value is connected to the position regulator.	Default: 0.00 Min/Max: -/+220000000.00	RO	32-bit Integer																																																																																																	
1474	<b>755 DI PCAM Start</b>  Digital Input Position Camming Start  Selects the digital input used to start the position camming sequence.	Default: 0.00 Min/Max: 0.00 / 159999.15	RW	32-bit Integer																																																																																																	

File	Group	No.	Display Name Full Name Description	Values	Read-Write	Data Type																																																			
APPLICATIONS	Roll Position	1500	<b>755 Roll Psn Config</b> Roll Position Indicator Configuration Configuration for the Roll Position Indicator function.  Options <table border="1"> <tr> <td>Reserved</td><td>Reserved</td><td>Reserved</td><td>Reserved</td><td>Reserved</td><td>Reserved</td><td>Reserved</td><td>Reserved</td><td>Reserved</td><td>Reserved</td><td>Reserved</td><td>Reserved</td><td>Reserved</td><td>EGR Select</td><td>Rereference</td><td>Preset</td><td>Enable</td> </tr> <tr> <td>0</td><td>0</td><td>0</td><td>0</td><td>0</td><td>0</td><td>0</td><td>0</td><td>0</td><td>0</td><td>0</td><td>0</td><td>0</td><td>0</td><td>0</td><td>0</td> </tr> <tr> <td>Bit</td><td>15</td><td>14</td><td>13</td><td>12</td><td>11</td><td>10</td><td>9</td><td>8</td><td>7</td><td>6</td><td>5</td><td>4</td><td>3</td><td>2</td><td>1</td><td>0</td> </tr> </table> 0 = Disabled 1 = Enabled  Bit 0 "Enable" – Enables the Roll Position Indicator function. Bit 1 "Preset" – At rising edge of this bit, P1504 [Roll Psn Preset] is loaded in P1505 [Roll Psn Offset]. Bit 2 "Rereference" – Permit changing the offset value of P1511 [RP Psn Output] without affecting actual position. Bit 3 "EGR Select" – 0 = EGR with gear ratio input as numerator and gear ratio output as denominator. 1 = EGR with gear ratio output as numerator and gear ratio input as denominator.	Reserved	Reserved	Reserved	Reserved	Reserved	Reserved	Reserved	Reserved	Reserved	Reserved	Reserved	Reserved	Reserved	EGR Select	Rereference	Preset	Enable	0	0	0	0	0	0	0	0	0	0	0	0	0	0	0	0	Bit	15	14	13	12	11	10	9	8	7	6	5	4	3	2	1	0		RW	16-bit Integer	
		Reserved	Reserved	Reserved	Reserved	Reserved	Reserved	Reserved	Reserved	Reserved	Reserved	Reserved	Reserved	Reserved	EGR Select	Rereference	Preset	Enable																																							
		0	0	0	0	0	0	0	0	0	0	0	0	0	0	0	0																																								
		Bit	15	14	13	12	11	10	9	8	7	6	5	4	3	2	1	0																																							
		1501	<b>755 Roll Psn Status</b> Roll Position Indicator Status Status of the Roll Position Indicator function.  Options <table border="1"> <tr> <td>Reserved</td><td>Reserved</td><td>Reserved</td><td>Reserved</td><td>Reserved</td><td>Reserved</td><td>Reserved</td><td>Reserved</td><td>Reserved</td><td>Reserved</td><td>Reserved</td><td>Reserved</td><td>Reserved</td><td>Reserved</td><td>Reserved</td><td>Rereference</td><td>Enable</td> </tr> <tr> <td>0</td><td>0</td><td>0</td><td>0</td><td>0</td><td>0</td><td>0</td><td>0</td><td>0</td><td>0</td><td>0</td><td>0</td><td>0</td><td>0</td><td>0</td><td>0</td><td>0</td> </tr> <tr> <td>Bit</td><td>15</td><td>14</td><td>13</td><td>12</td><td>11</td><td>10</td><td>9</td><td>8</td><td>7</td><td>6</td><td>5</td><td>4</td><td>3</td><td>2</td><td>1</td><td>0</td> </tr> </table> 0 = Disabled 1 = Enabled  Bit 0 "Enable" – Acknowledges that Roll Position Indicator function is enabled. Bit 1 "Rereference" – Acknowledges that rereferencing of P1511 [RP Psn Output] is active.	Reserved	Reserved	Reserved	Reserved	Reserved	Reserved	Reserved	Reserved	Reserved	Reserved	Reserved	Reserved	Reserved	Reserved	Reserved	Rereference	Enable	0	0	0	0	0	0	0	0	0	0	0	0	0	0	0	0	0	Bit	15	14	13	12	11	10	9	8	7	6	5	4	3	2	1	0		RO	16-bit Integer
		Reserved	Reserved	Reserved	Reserved	Reserved	Reserved	Reserved	Reserved	Reserved	Reserved	Reserved	Reserved	Reserved	Reserved	Reserved	Rereference	Enable																																							
		0	0	0	0	0	0	0	0	0	0	0	0	0	0	0	0	0																																							
Bit	15	14	13	12	11	10	9	8	7	6	5	4	3	2	1	0																																									
1502	<b>755 RP Psn Fdbk Stpt</b> Roll Position Position Indicator Feedback Setpoint Provides a set point for the position feedback value in the form of accumulated encoder counts.	Default: 0 Min/Max: -2147483648 / 2147483647	RW	32-bit Integer																																																					
1503	 <b>755 RP Psn Fdbk Sel</b> Roll Position Position Indicator Feedback Select  Selects source data for the position feedback. The function generates P1511 [RP Psn Output] based on the selected position feedback source.	Default: 1502 Min/Max: 0 / 159999	RW	32-bit Integer																																																					
1504	<b>755 Roll Psn Preset</b> Roll Position Indicator Preset Provides a pre-set position value. At rising edge of Bit 1 "Preset" in P1500 [Roll Psn Config], this parameter value is loaded in P1511 [RP Psn Output]. Note: P1511 [RP Psn Output] is limited by P1509 [RP Unwind].	Default: 0 Min/Max: -2147483648 / 2147483647	RW	32-bit Integer																																																					
1505	<b>755 Roll Psn Offset</b> Roll Position Indicator Offset Provides position offset, which is summed after the EPR and used to trim the phase of the position feedback.	Default: 0 Min/Max: -2147483648 / 2147483647	RW	32-bit Integer																																																					
1506	<b>755 RP EPR Input</b> Roll Position Indicator Edges Per Revolution Input Sets edges per revolution of the physical input device such as the motor encoder.	Default: 4096 Min/Max: 1 / 67108864	RW	32-bit Integer																																																					

File	Group	No.	Display Name Full Name Description	Values	Read-Write	Data Type
APPLICATIONS	Roll Position	1507	<b>755 RP Rvls Input</b> Roll Position Indicator Revolutions Input Sets revolution of the input encoder. This parameter must be coordinated with the revolution of the output encoder P1508 [RP Rvls Output] to resolve the gear ratio between input revolutions and output (virtual) revolutions. The ratio of input to output revolutions can always be resolved into integer values and should be reduce to their lowest common factor.	Default: 1 Min/Max: -/+1000000	RW	32-bit Integer
		1508	<b>755 RP Rvls Output</b> Roll Position Indicator Revolutions Output Sets revolution of the output encoder. This parameter must be coordinated with the revolution of the input encoder P1507 [RP Rvls Input] to resolve the gear ratio between input revolutions and output (virtual) revolutions. The ratio of input to output revolutions can always be resolved into integer values and should be reduce to their lowest common factor.	Default: 1 Min/Max: 1 / 4294967295	RW	32-bit Integer
		1509	<b>755 RP Unwind</b> Roll Position Indicator Unwind Count Sets the number of counts per roll revolution. P1511 [RP Psn Output] rolls over at this count minus 1.	Default: 4194304 Min/Max: 1024 / 536870912	RW	32-bit Integer
		1510	<b>755 RP Unit Scale</b> Roll Position Indicator Unit Scale Provides the multiplier to P1512 [RP Unit Out], which is a floating point output of P1511 [RP Psn Output].	Default: 1.00000 Min/Max: -/+220000000.00000	RW	Real
		1511	<b>755 RP Psn Output</b> Roll Position Indicator Position Output Output of roll position, which has a span limited by P1509 [RP Unwind].	Default: 0 Min/Max: 0 / 4294967295	RO	32-bit Integer
		1512	<b>755 RP Unit Out</b> Roll Position Indicator Unit Output Floating point output that results from multiplying P1511 [RP Psn Output] by P1510 [RP Unit Scale].	Default: 0.00 Min/Max: -/+220000000.00	RO	Real

File	Group	No.	Display Name Full Name Description	Values	Read-Write	Data Type																																																						
APPLICATIONS	Torque Boost	1515	<b>755 PsnTrqBst Ctrl</b> Position Oriented Torque Boost Control Configuration for the Position Oriented Torque Boost function.  Options <table border="1" style="display: inline-table; vertical-align: middle;"> <tr> <td></td> <td>Reserved</td><td>Reserved</td><td>Reserved</td><td>Reserved</td><td>Reserved</td><td>Reserved</td><td>Reserved</td><td>Reserved</td><td>Reserved</td><td>Reserved</td><td>Reserved</td><td>Reserved</td><td>Reserved</td><td>Reserved</td><td>Reserved</td><td>Reserved</td><td>Boost Enable</td> </tr> <tr> <td>Default</td> <td>0</td><td>0</td><td>0</td><td>0</td><td>0</td><td>0</td><td>0</td><td>0</td><td>0</td><td>0</td><td>0</td><td>0</td><td>0</td><td>0</td><td>0</td><td>0</td><td>0</td> </tr> <tr> <td>Bit</td> <td>15</td><td>14</td><td>13</td><td>12</td><td>11</td><td>10</td><td>9</td><td>8</td><td>7</td><td>6</td><td>5</td><td>4</td><td>3</td><td>2</td><td>1</td><td>0</td><td></td> </tr> </table> Bit 0 "Boost Enable" – Enables the Position Oriented Torque Boost function.		Reserved	Reserved	Reserved	Reserved	Reserved	Reserved	Reserved	Reserved	Reserved	Reserved	Reserved	Reserved	Reserved	Reserved	Reserved	Reserved	Boost Enable	Default	0	0	0	0	0	0	0	0	0	0	0	0	0	0	0	0	0	Bit	15	14	13	12	11	10	9	8	7	6	5	4	3	2	1	0		0 = Disabled 1 = Enabled	RW	16-bit Integer
	Reserved	Reserved	Reserved	Reserved	Reserved	Reserved	Reserved	Reserved	Reserved	Reserved	Reserved	Reserved	Reserved	Reserved	Reserved	Reserved	Boost Enable																																											
Default	0	0	0	0	0	0	0	0	0	0	0	0	0	0	0	0	0																																											
Bit	15	14	13	12	11	10	9	8	7	6	5	4	3	2	1	0																																												

File	Group	No.	Display Name Full Name Description	Values	Read-Write	Data Type																																																
APPLICATIONS	Torque Boost	1516	<b>755 PsnTrqBst Sts</b> Position Oriented Torque Boost Status Status of the Position Oriented Torque Boost function.  Options <table border="1" style="display: inline-table; vertical-align: middle;"> <tr> <td>Reserved</td><td>Reserved</td><td>Reserved</td><td>Reserved</td><td>Reserved</td><td>Reserved</td><td>Reserved</td><td>Reserved</td><td>Reserved</td><td>Reserved</td><td>Reserved</td><td>Reserved</td><td>Reserved</td><td>Reserved</td><td>In Position</td><td>Enabled</td> </tr> <tr> <td>0</td><td>0</td><td>0</td><td>0</td><td>0</td><td>0</td><td>0</td><td>0</td><td>0</td><td>0</td><td>0</td><td>0</td><td>0</td><td>0</td><td>0</td><td>0</td> </tr> <tr> <td>15</td><td>14</td><td>13</td><td>12</td><td>11</td><td>10</td><td>9</td><td>8</td><td>7</td><td>6</td><td>5</td><td>4</td><td>3</td><td>2</td><td>1</td><td>0</td> </tr> </table>	Reserved	Reserved	Reserved	Reserved	Reserved	Reserved	Reserved	Reserved	Reserved	Reserved	Reserved	Reserved	Reserved	Reserved	In Position	Enabled	0	0	0	0	0	0	0	0	0	0	0	0	0	0	0	0	15	14	13	12	11	10	9	8	7	6	5	4	3	2	1	0		RO	16-bit Integer
		Reserved	Reserved	Reserved	Reserved	Reserved	Reserved	Reserved	Reserved	Reserved	Reserved	Reserved	Reserved	Reserved	Reserved	In Position	Enabled																																					
		0	0	0	0	0	0	0	0	0	0	0	0	0	0	0	0																																					
		15	14	13	12	11	10	9	8	7	6	5	4	3	2	1	0																																					
		1517	<b>755 PsnTrqBst RefSel</b>  Position Oriented Torque Boost Reference Select Selects a source data for the position reference.	Default: 1511 Min/Max: 0 / 159999	RW	32-bit Integer																																																
		1518	<b>755 PsnTrqBstPsnOfst</b> Position Oriented Torque Boost Position Offset Provides position offset, which is summed to the position reference and used to trim the phase of it.	Default: 0 Min/Max: -2147483648 / 2147483647	RW	32-bit Integer																																																
		1519	<b>755 PsnTrqBst UNWCnt</b> Position Oriented Torque Boost Unwind Count Sets the number of counts per roll revolution. The selected position reference internally rolls over at this count minus 1.	Default: 4194304 Min/Max: 1024 / 2147483647	RW	32-bit Integer																																																
		1520	<b>755 PsnTrqBst Ps X1</b>	Default: 0 Min/Max: 0 / 2147483647	RW	32-bit Integer																																																
		1521	<b>755 PsnTrqBst Ps X2</b>																																																			
		1522	<b>755 PsnTrqBst Ps X3</b>																																																			
1523	<b>755 PsnTrqBst Ps X4</b>																																																					
1524	<b>755 PsnTrqBst Ps X5</b>																																																					
		Position Oriented Torque Boost Position $X_n$ The torque/position profile is built by specifying endpoint position counts for X1, X2, X3, X4, and X5, and corresponding per unit torque values for Y2, Y3, and Y4. The torque values corresponding to the points X1 and X5 are zero.																																																				
1525	<b>755 PsnTrqBst Trq Y2</b>	Default: 0.00 Min/Max: -/+2.00	RW	Real																																																		
1526	<b>755 PsnTrqBst Trq Y3</b>																																																					
1527	<b>755 PsnTrqBst Trq Y4</b>																																																					
		Position Oriented Torque Boost Torque $Y_n$ The position profile from X1 to X5 must be ascending order. The torque profile from Y2 and Y4 is free form with no restriction.																																																				
1528	<b>755 PsnTrqBst TrqOut</b> Position Oriented Torque Boost Torque Output Output of the Position Oriented Torque Boost, which is the torque taken from the profile at the position target.	Default: 0.00 Min/Max: -/+2.00	RO	Real																																																		

File	Group	No.	Display Name Full Name Description	Values	Read-Write	Data Type																																																			
APPLICATIONS	Variable Boost	1535	<b>VB Config</b> Variable Boost Configuration Controls the variable boost function.  Options <table border="1"> <thead> <tr> <th></th> <th>Reserved</th> <th>Reserved</th> <th>Reserved</th> <th>Reserved</th> <th>Reserved</th> <th>Reserved</th> <th>Reserved</th> <th>Reserved</th> <th>Reserved</th> <th>Reserved</th> <th>Reserved</th> <th>Minimum Freq</th> <th>Flux Level</th> <th>Rising Edge</th> <th>Current Rate</th> <th>VB Enable</th> </tr> </thead> <tbody> <tr> <td>Default</td> <td>0</td> <td>0</td> <td>0</td> <td>0</td> <td>0</td> <td>0</td> <td>0</td> <td>0</td> <td>0</td> <td>0</td> <td>0</td> <td>0</td> <td>0</td> <td>0</td> <td>0</td> <td>0</td> </tr> <tr> <td>Bit</td> <td>15</td> <td>14</td> <td>13</td> <td>12</td> <td>11</td> <td>10</td> <td>9</td> <td>8</td> <td>7</td> <td>6</td> <td>5</td> <td>4</td> <td>3</td> <td>2</td> <td>1</td> <td>0</td> </tr> </tbody> </table> <p>0 = Disabled 1 = Enabled</p> <p>Bit 0 "VB Enable" – Enables the variable boost voltage function.                      Bit 1 "Current Rate" – The current rate trigger condition is defined by the level set in P1550 [VB Cur Thresh] with a hysteresis band of P1549 [VB Current Hyst]. The slope of P1548 [VB Current Rate] is set to either default falling edge or rising edge by Bit 2 "Rising Edge." If these trigger conditions are met, P1536 [VB Status] Bit 3 "Current Trig" is set.                      Bit 2 "Rising Edge" – The current rate trigger condition is defined by the level set in P1550 [VB Cur Thresh] with a hysteresis band of 1549 [VB Current Hyst]. The slope of P1548 [VB Current Rate] is set to either default falling edge or rising edge by Bit 2 "Rising Edge." If these trigger conditions are met, P1536 [VB Status] Bit 3 "Current Trig" is set.                      Bit 3 "Flux Level" – Sets the flux trigger condition defined by the level of P1545 [VB Flux Thresh]. If P1547 [VB Filt Flux Cur] is greater than or equal to P1545 [VB Flux Thresh], P1536 [VB Status] Bit 4 "Flux Trigger" is set.                      Bit 4 "Minimum Freq" – Sets the minimum frequency trigger source derived from P1 [Output Frequency] and is enabled by setting P1535 [VB Config] Bit 4 "Minimum Freq." If P1 [Output Frequency] is less than or equal to P1544 [VB Min Freq], P1536 [VB Status] Bit 5 "Freq Trigger" is set.</p>		Reserved	Reserved	Reserved	Reserved	Reserved	Reserved	Reserved	Reserved	Reserved	Reserved	Reserved	Minimum Freq	Flux Level	Rising Edge	Current Rate	VB Enable	Default	0	0	0	0	0	0	0	0	0	0	0	0	0	0	0	0	Bit	15	14	13	12	11	10	9	8	7	6	5	4	3	2	1	0		RO	16-bit Integer
			Reserved	Reserved	Reserved	Reserved	Reserved	Reserved	Reserved	Reserved	Reserved	Reserved	Reserved	Minimum Freq	Flux Level	Rising Edge	Current Rate	VB Enable																																							
		Default	0	0	0	0	0	0	0	0	0	0	0	0	0	0	0	0																																							
Bit	15	14	13	12	11	10	9	8	7	6	5	4	3	2	1	0																																									
1536	<b>VB Status</b> Variable Boost Status Status bits for the variable boost function.  Options <table border="1"> <thead> <tr> <th></th> <th>Reserved</th> <th>Reserved</th> <th>Reserved</th> <th>Reserved</th> <th>Reserved</th> <th>Reserved</th> <th>Reserved</th> <th>Reserved</th> <th>Hold Freq</th> <th>Max Boost</th> <th>Freq Trigger</th> <th>Flux Trigger</th> <th>Current Trig</th> <th>Triggered</th> <th>VB Timer</th> <th>VB Enabled</th> </tr> </thead> <tbody> <tr> <td>Default</td> <td>0</td> <td>0</td> <td>0</td> <td>0</td> <td>0</td> <td>0</td> <td>0</td> <td>0</td> <td>0</td> <td>0</td> <td>0</td> <td>0</td> <td>0</td> <td>0</td> <td>0</td> <td>0</td> </tr> <tr> <td>Bit</td> <td>15</td> <td>14</td> <td>13</td> <td>12</td> <td>11</td> <td>10</td> <td>9</td> <td>8</td> <td>7</td> <td>6</td> <td>5</td> <td>4</td> <td>3</td> <td>2</td> <td>1</td> <td>0</td> </tr> </tbody> </table> <p>0 = Condition False 1 = Condition True</p> <p>Bit 0 "VB Enabled" – The variable boost voltage function is enabled.                      Bit 1 "VB Timer" – P1538 [VB Time] has expired.                      Bit 2 "Triggered" – Indicates that a trigger function has been enabled by 1535 [VB Config].                      Bit 3 "Current Trig" – This trigger condition is defined by P1550 [VB Cur Thresh] with a hysteresis band of P1549 [VB Current Hyst]. The slope of P1548 [VB Current Rate] is set to either default falling edge or rising edge by P1535 [VB Config] Bit 2 "Rising Edge." If these trigger conditions are met, this bit is set.                      Bit 4 "Flux Trigger" – This trigger event is enabled by P1535 [VB Config] Bit 3 "Flux Level." The trigger condition is defined by the level P1545 [VB Flux Thresh]. If P1547 [VB Filt Flux Cur] is greater than or equal to P1545 [VB Flux Thresh], P1536 [VB Status] Bit 4 "Flux Trigger" is set.                      Bit 5 "Freq Trigger" – This trigger event is enabled when P1 [Output Frequency] is less than or equal to P1544 [VB Min Freq].                      Bit 6 "Max Boost" – This trigger event is enabled when P1537 [VB Voltage] reaches P1540 [VB Maximum] before any of the other trigger events cause P1537 [VB Voltage] to ramp down.                      Bit 7 "Hold Freq" – Output frequency is being held at P1543 [VB Frequency].</p>		Reserved	Reserved	Reserved	Reserved	Reserved	Reserved	Reserved	Reserved	Hold Freq	Max Boost	Freq Trigger	Flux Trigger	Current Trig	Triggered	VB Timer	VB Enabled	Default	0	0	0	0	0	0	0	0	0	0	0	0	0	0	0	0	Bit	15	14	13	12	11	10	9	8	7	6	5	4	3	2	1	0		RO	16-bit Integer		
	Reserved	Reserved	Reserved	Reserved	Reserved	Reserved	Reserved	Reserved	Hold Freq	Max Boost	Freq Trigger	Flux Trigger	Current Trig	Triggered	VB Timer	VB Enabled																																									
Default	0	0	0	0	0	0	0	0	0	0	0	0	0	0	0	0																																									
Bit	15	14	13	12	11	10	9	8	7	6	5	4	3	2	1	0																																									
1537	<b>VB Voltage</b> Variable Boost Voltage Displays the output value of the voltage-axis intercept of the V/Hz curve. When the variable boost function is enabled, the value of [VB Voltage] is ramped up/down according to the settings of the variable boost function when the drive is running. This parameter is equal to P60 [Start Acc Boost] and P61 [Run Boost] when the drive is stopped or when P1535 [VB Config] Bit 0 "VB Enable" = 0.	Units: V AC Default: 0.0 Min/Max: 0.0 / 460.0	RO	Real																																																					

File	Group	No.	Display Name Full Name Description	Values	Read-Write	Data Type
APPLICATIONS	Variable Boost	1538	<b>VB Time</b> Variable Boost Time Sets the time delay for which the variable voltage boost trigger becomes active following a drive start. This parameter begins counting down when the drive enters the run state. Valid trigger conditions may only be met in the time following the expiration of [VB Time] to cause a trigger event. This time delay does not affect the trigger condition associated with P1540 [VB Maximum].	Units: Secs Default: 1.0 Min/Max: 0.0 / 100.0	RW	Real
		1539	<b>VB Minimum</b> Variable Boost Minimum Sets the minimum boost voltage level for the variable boost voltage function. If P1537 [VB Voltage] reaches P1540 [VB Maximum] voltage or one of the variable boost voltage trigger events occurs then P1537 [VB Voltage] decelerates at the rate corresponding to P1542 [VB Decel Rate].	Units: V AC Default: 2.0 Min/Max: 0.0 / 200.0	RW	Real
		1540	<b>VB Maximum</b> Variable Boost Maximum Sets the maximum boost voltage level for the variable boost voltage function. If P1537 [VB Voltage] reaches [VB Maximum] voltage then [VB Voltage] decelerates at the rate corresponding to P1542 [VB Decel Rate].	Units: V AC Default: 10.0 Min/Max: 0.0 / 200.0	RW	Real
		1541	<b>VB Accel Rate</b> Variable Boost Acceleration Rate Sets the rate of acceleration of P1537 [VB Voltage] for the variable boost voltage function.	Units: V/s Default: 0.75 Min/Max: 0.01 / 537.67	RW	Real
		1542	<b>VB Decel Rate</b> Variable Boost Deceleration Rate Sets the rate of deceleration of P1537 [VB Voltage] for the variable boost voltage function following a trigger event.	Units: V/s Default: 6.00 Min/Max: 0.01 / 537.67	RW	Real
		1543	<b>VB Frequency</b> Variable Boost Frequency Sets the initial frequency reference for the variable boost voltage function.	Units: Hz Default: 0.8 Min/Max: 0.0 / 110.0	RW	Real
		1544	<b>VB Min Freq</b> Variable Boost Minimum Frequency Sets the frequency reference trigger level for the variable boost voltage function. P1536 [VB Status] Bit 5 "Freq Trigger" is set to 1 when P1 [Output Frequency] falls below [VB Min Freq]. To enable this threshold and trigger event: Set P1535 [VB Config] Bit 0 "VB Enable" to 1 and Bit 4 "Minimum Freq" to 1.	Units: Hz Default: 0.5 Min/Max: 0.0 / 110.0	RW	Real
		1545	<b>VB Flux Thresh</b> Variable Boost Flux Threshold Sets the flux current trigger level for the variable boost voltage function. P1536 [VB Status] Bit 4 "Flux Trigger" is set to 1 when P1547 [VB Filt Flux Cur] exceeds [VB Flux Thresh]. To enable this threshold and trigger event: Set P1535 [VB Config] Bit 0 "VB Enable" to 1 and Bit 3 "Flux Level" to 1.	Units: Amps Default: P21 [Rated Amps] x 0.5 Min/Max: 0.0 / P21 [Rated Amps]	RW	Real
		1546	<b>VB Flux Lag Freq</b> Variable Boost Flux Lag Frequency Sets the lag (cutoff) frequency of the P6 [Flux Cur Fdbk] low pass filter. The output of this filter is displayed in P1547 [VB Filt Flux Cur].	Units: R/S Default: 0.60 Min/Max: 0.01 / 100.00	RW	Real
		1547	<b>VB Filt Flux Cur</b> Variable Boost Filter Flux Current Filtered version of the P6 [Flux Cur Fdbk]. P1546 [VB Flux Lag Freq] sets the cutoff frequency of the low pass filter.	Units: Amps Default: 0.0 Min/Max: 0.0 / P21 [Rated Amps] x 2	RO	Real



File	Group	No.	Display Name Full Name Description	Values	Read-Write	Data Type
APPLICATIONS	Variable Boost	1548	<b>VB Current Rate</b> Variable Boost Current Rate Output current rate of change.	Default: 0.0 Min/Max: -/+1000.0	RO	Real
		1549	<b>VB Current Hyst</b> Variable Boost Current Hysteresis Sets the hysteresis level around P1550 [VB Cur Thresh] for the variable boost voltage function.	Default: 0.0 Min/Max: -/+100.0	RW	Real
		1550	<b>VB Cur Thresh</b> Variable Boost Current Threshold Sets the P1548 [VB Current Rate] trigger level for the variable boost voltage function. The trigger is not active until P1538 [VB Time] time has expired following a drive start. P1535 [VB Config] Bit 2 "Rising Edge" = 0: The value of [VB Current Rate] must first pass through [VB Cur Thresh] + P1549 [VB Current Hyst] then [VB Cur Thresh] in order to cause a boost voltage trigger event. P1535 [VB Config] Bit 2 "Rising Edge" = 1: The value of P1548 [VB Current Rate] must first pass through [VB Cur Thresh] - P1549 [VB Current Hyst] then [VB Cur Thresh] in order to cause a boost voltage trigger event.	Default: -25.0 Min/Max: -/+1000.0	RW	Real
		1551	<b>VB Rate Lag Freq</b> Variable Boost Rate Lag Frequency Sets the lag (cutoff) frequency of the current magnitude low pass filter. The output of this filter is displayed in P1548 [VB Current Rate].	Units: R/S Default: 2.60 Min/Max: 0.01 / 100.00	RW	Real

1560 See [page 137](#) for parameters numbers 1560...1567.

File	Group	No.	Display Name Full Name Description	Values	Read-Write	Data Type																																																
APPLICATIONS	Spindle Orient		<b>Important:</b> After the Spindle Orient group is set up for an application, any subsequent changes to parameter settings will require a drive reset for the changes to take affect.																																																			
		1580	<b>755 SO Config</b> Spindle Orientation Configuration Configures the options for the Spindle Orientation function. Function requires P35 [Motor Ctrl Mode] is set to option 3 "Induction FV," 6 "PM FV," or 10 "IPM FV." P125 [Pri Vel Fdbk Sel] and P135 [Psn Fdbk Sel] must also be set up accordingly.  Options <table border="1" style="display: inline-table; vertical-align: top;"> <tr> <td></td> <td>Reserved</td> <td>Reserved</td> <td>Reserved</td> <td>Reserved</td> <td>Reserved</td> <td>Reserved</td> <td>Reserved</td> <td>Reserved</td> <td>Reserved</td> <td>Reserved</td> <td>Reserved</td> <td>Scale Invert</td> <td>ShortestPath</td> <td>Recap Hm Psn</td> <td>Home DI Inv</td> <td>Home DI</td> </tr> <tr> <td>Default</td> <td>0</td> <td>0</td> <td>0</td> <td>0</td> <td>0</td> <td>0</td> <td>0</td> <td>0</td> <td>0</td> <td>0</td> <td>0</td> <td>0</td> <td>0</td> <td>0</td> <td>0</td> <td>0</td> </tr> <tr> <td>Bit</td> <td>15</td> <td>14</td> <td>13</td> <td>12</td> <td>11</td> <td>10</td> <td>9</td> <td>8</td> <td>7</td> <td>6</td> <td>5</td> <td>4</td> <td>3</td> <td>2</td> <td>1</td> <td>0</td> </tr> </table> 0 = Disabled 1 = Enabled  Bit 0 "Home DI" – Selects the type of Homing signal (Marker Pulse vs. Digital Input Switch). 1 = Home signal. 0 = Z Channel. Bit 1 "Home DI Inv" – Rising/Falling Edge of Homing Input. Bit 2 "Recap Hm Psnv" – Re-capture Home Position. Allows the drive to find Home after a power or drive reset. Typically set to 1 "Enabled." Bit 3 "ShortestPath" – Allow direction reversal to obtain shortest distance traveled. Bit 4 "Scale Invert" – Inverts the calculation for the user-defined units value. This improves resolution as the value of P1587 [SO Cnts per Rvls] increases.		Reserved	Reserved	Reserved	Reserved	Reserved	Reserved	Reserved	Reserved	Reserved	Reserved	Reserved	Scale Invert	ShortestPath	Recap Hm Psn	Home DI Inv	Home DI	Default	0	0	0	0	0	0	0	0	0	0	0	0	0	0	0	0	Bit	15	14	13	12	11	10	9	8	7	6	5	4	3	2	1	0
	Reserved	Reserved	Reserved	Reserved	Reserved	Reserved	Reserved	Reserved	Reserved	Reserved	Reserved	Scale Invert	ShortestPath	Recap Hm Psn	Home DI Inv	Home DI																																						
Default	0	0	0	0	0	0	0	0	0	0	0	0	0	0	0	0																																						
Bit	15	14	13	12	11	10	9	8	7	6	5	4	3	2	1	0																																						





File	Group	No.	Display Name Full Name Description	Values	Read-Write	Data Type
APPLICATIONS	Spindle Orient	1592	<b>755 SO Decel Time</b> Spindle Orientation Deceleration Time Sets the deceleration rate used during positioning.	Units: Secs Default: 10.00 Min/Max: 0.00 / 3600.00	RW	Real
		1593	<b>755 SO Fwd Vel Lmt</b>  Spindle Orientation Forward Velocity Limit Sets the forward speed used during positioning.	Units: Hz / RPM Default: 30.00 Min/Max: 0.00 / 40000.00	RW	Real
		1594	<b>755 SO Rev Vel Lmt</b>  Spindle Orientation Reverse Velocity Limit Sets the reverse speed used during positioning.	Units: Hz / RPM Default: -30.00 Min/Max: -40000.00 / 0.00	RW	Real

File	Group	No.	Display Name Full Name Description	Values	Read-Write	Data Type
APPLICATIONS	Id Compensation	1600	<b>755 Id Comp Enbl</b> Id Compensation Enable Enables or disables the Id compensation calculation. This selection is active only in motor control mode flux vector induction (P35 [Motor Ctrl Mode] = 3 "Induction FV").	Default: 0 = "Disable" Options: 0 = "Disable" 1 = "Enable"	RW	32-bit Integer
		1601	<b>755 Id Comp Mtrng 1</b> Id Compensation Motoring 1 Sets Id compensation value (in p.u.) at Iq = P1602 [IdCompMtrng 1 Iq] (in p.u.) for motoring operation. Id compensation = [Id Comp Mtrng 1] x IqCmd (in p.u.) for IqCmd = between 0 and P1602 [IdCompMtrng 1 Iq]. 1.0 p.u. is scaled to the motor rated current. This parameter is active only in motor control mode flux vector induction (P35 [Motor Ctrl Mode] = 3 "Induction FV").	Default: 0.0000 Min/Max: -/+1.0000	RW	Real
		1602	<b>755 IdCompMtrng 1 Iq</b> Id Compensation Motoring 1 Iq Sets Iq value (in p.u.) at which P1601 [Id Comp Mtrng 1] (in p.u.) is specified. This parameter is active only in motor control mode flux vector induction (P35 [Motor Ctrl Mode] = 3 "Induction FV").	Default: 0.2500 Min/Max: 0.0000 / 5.0000	RW	Real
		1603	<b>755 Id Comp Mtrng 2</b> Id Compensation Motoring 2 Sets Id compensation value (in p.u.) at Iq = P1604 [IdCompMtrng 2 Iq] (in p.u.) for motoring operation. Id compensation = P1601 [Id Comp Mtrng 1] + (Id Comp Mtrng 2 - Id Comp Mtrng 1) x (IqCmd - IdCompMtrng 1 Iq) x 1/(IdCompMtrng 2 Iq - IdCompMtrng 1 Iq) for IqCmd = between IdCompMtrng 1 Iq and IdCompMtrng 2 Iq. 1.0 p.u. is scaled to the motor rated current. This parameter is active only in motor control mode flux vector induction (P35 [Motor Ctrl Mode] = 3 "Induction FV").	Default: 0.0000 Min/Max: -/+1.0000	RW	Real
		1604	<b>755 IdCompMtrng 2 Iq</b> Id Compensation Motoring 2 Iq Sets Iq value (in p.u.) at which P1603 [Id Comp Mtrng 2] (in p.u.) is specified. This parameter is active only in motor control mode flux vector induction (P35 [Motor Ctrl Mode] = 3 "Induction FV").	Default: 0.5000 Min/Max: 0.0000 / 5.0000	RW	Real
		1605	<b>755 Id Comp Mtrng 3</b> Id Compensation Motoring 3 Sets Id compensation value (in p.u.) at Iq = P1606 [IdCompMtrng 3 Iq] (in p.u.) for motoring operation. Id compensation = Id Comp Mtrng 2 + (Id Comp Mtrng 3 - Id Comp Mtrng 2) x (IqCmd - IdCompMtrng 2 Iq) x 1/(IdCompMtrng 3 Iq - IdCompMtrng 2 Iq) for IqCmd = between IdCompMtrng 2 Iq and IdCompMtrng 3 Iq. 1.0 p.u. is scaled to the motor rated current. This parameter is active only in motor control mode flux vector induction (P35 [Motor Ctrl Mode] = 3 "Induction FV").	Default: 0.0000 Min/Max: -/+1.0000	RW	Real

File	Group	No.	Display Name Full Name Description	Values		Read-Write	Data Type
APPLICATIONS	Id Compensation	1606	<b>755 IdCompMtrng 3 lq</b> Id Compensation Motoring 3 lq Sets lq value (in p.u.) at which P1605 [Id Comp Mtrng 3] (in p.u.) is specified. This parameter is active only in motor control mode flux vector induction (P35 [Motor Ctrl Mode] = 3 "Induction FV").	Default: Min/Max:	0.7500 0.0000 / 5.0000	RW	Real
		1607	<b>755 Id Comp Mtrng 4</b> Id Compensation Motoring 4 Sets Id compensation value (in p.u.) at lq = P1608 [IdCompMtrng 4 lq] (in p.u.) for motoring operation. Id compensation = Id Comp Mtrng 3 + (Id Comp Mtrng 4 – Id Comp Mtrng 3) x (lqCmd – IdCompMtrng 3 lq) x 1/(IdCompMtrng 4 lq – IdCompMtrng 3 lq) for lqCmd = between IdCompMtrng 3 lq and IdCompMtrng 4 lq. 1.0 p.u. is scaled to the motor rated current. This parameter is active only in motor control mode flux vector induction (P35 [Motor Ctrl Mode] = 3 "Induction FV").	Default: Min/Max:	0.0000 -/+1.0000	RW	Real
		1608	<b>755 IdCompMtrng 4 lq</b> Id Compensation Motoring 4 lq Sets lq value (in p.u.) at which P1607 [Id Comp Mtrng 4] (in p.u.) is specified. This parameter is active only in motor control mode flux vector induction (P35 [Motor Ctrl Mode] = 3 "Induction FV").	Default: Min/Max:	1.0000 0.0000 / 5.0000	RW	Real
		1609	<b>755 Id Comp Mtrng 5</b> Id Compensation Motoring 5 Sets Id compensation value (in p.u.) at lq = P1610 [IdCompMtrng 5 lq] (in p.u.) for motoring operation. Id compensation = Id Comp Mtrng 4 + (Id Comp Mtrng 5 – Id Comp Mtrng 4) x (lqCmd – IdCompMtrng 4 lq) x 1/(IdCompMtrng 5 lq – IdCompMtrng 4 lq) for lqCmd = between IdCompMtrng 4 lq and IdCompMtrng 5 lq. 1.0 p.u. is scaled to the motor rated current. This parameter is active only in motor control mode flux vector induction (P35 [Motor Ctrl Mode] = 3 "Induction FV").	Default: Min/Max:	0.0000 -/+1.0000	RW	Real
		1610	<b>755 IdCompMtrng 5 lq</b> Id Compensation Motoring 5 lq Sets lq value (in p.u.) at which P1609 [Id Comp Mtrng 5] (in p.u.) is specified. This parameter is active only in motor control mode flux vector induction (P35 [Motor Ctrl Mode] = 3 "Induction FV").	Default: Min/Max:	1.2500 0.0000 / 5.0000	RW	Real
		1611	<b>755 Id Comp Mtrng 6</b> Id Compensation Motoring 6 Sets Id compensation value (in p.u.) at lq = P1612 [IdCompMtrng 6 lq] (in p.u.) for motoring operation. Id compensation = Id Comp Mtrng 5 + (Id Comp Mtrng 6 – Id Comp Mtrng 5) x (lqCmd – IdCompMtrng 5 lq) x 1/(IdCompMtrng 6 lq – IdCompMtrng 5 lq) for lqCmd = between IdCompMtrng 5 lq and IdCompMtrng 6 lq. 1.0 p.u. is scaled to the motor rated current. This parameter is active only in motor control mode flux vector induction (P35 [Motor Ctrl Mode] = 3 "Induction FV").	Default: Min/Max:	0.0000 -/+1.0000	RW	Real
		1612	<b>755 IdCompMtrng 6 lq</b> Id Compensation Motoring 6 lq Sets lq value (in p.u.) at which P1611 [Id Comp Mtrng 6] (in p.u.) is specified. This parameter is active only in motor control mode flux vector induction (P35 [Motor Ctrl Mode] = 3 "Induction FV").	Default: Min/Max:	1.5000 0.0000 / 5.0000	RW	Real
		1613	<b>755 Id Comp Regen 1</b> Id Compensation Regen 1 Sets Id compensation value (in p.u.) at P1614 lq = IdCompRegen 1 lq (in p.u.) for regenerative operation. Id compensation = Id Comp Regen 1 x lqCmd (in p.u.) for lqCmd = between 0 and IdCompRegen 1 lq. 1.0 p.u. is scaled to the motor rated current. This parameter is active only in motor control mode flux vector induction (P35 [Motor Ctrl Mode] = 3 "Induction FV").	Default: Min/Max:	0.0000 -/+1.0000	RW	Real

File	Group	No.	Display Name Full Name Description	Values		Read-Write	Data Type
APPLICATIONS	Id Compensation	1614	<b>755 IdCompRegen 1 Iq</b> Id Compensation Regen 1 Iq Sets Iq value (in p.u.) at which P1613 Id Comp Regen 1 (in p.u.) is specified. This parameter is active only in motor control mode flux vector induction (P35 [Motor Ctrl Mode] = 3 "Induction FV").	Default: Min/Max:	0.2500 0.0000 / 5.0000	RW	Real
		1615	<b>755 Id Comp Regen 2</b> Id Compensation Regen 2 Sets Id compensation value (in p.u.) at Iq = P1616 [IdCompRegen 2 Iq] (in p.u.) for regenerative operation. Id compensation = Id Comp Regen 1 + (Id Comp Regen 2 – Id Comp Regen 1) x (IqCmd – IdCompRegen 1 Iq) x 1/(IdCompRegen 2 Iq – IdCompRegen 1 Iq) for IqCmd = between IdCompRegen 1 Iq and IdCompRegen 2 Iq. This parameter is active only in motor control mode flux vector induction (P35 [Motor Ctrl Mode] = 3 "Induction FV").	Default: Min/Max:	0.0000 –/+1.0000	RW	Real
		1616	<b>755 IdCompRegen 2 Iq</b> Id Compensation Regen 2 Iq Sets Iq value (in p.u.) at which P1615 [Id Comp Regen 2] (in p.u.) is specified. This parameter is active only in motor control mode flux vector induction (P35 [Motor Ctrl Mode] = 3 "Induction FV").	Default: Min/Max:	0.5000 0.0000 / 5.0000	RW	Real
		1617	<b>755 Id Comp Regen 3</b> Id Compensation Regen 3 Sets Id compensation value (in p.u.) at Iq = P1618 [IdCompRegen 3 Iq] (in p.u.) for regenerative operation. Id compensation = Id Comp Regen 2 + (Id Comp Regen 3 – Id Comp Regen 2) x (IqCmd – IdCompRegen 2 Iq) x 1/(IdCompRegen 3 Iq – IdCompRegen 2 Iq) for IqCmd = between IdCompRegen 2 Iq and IdCompRegen 3 Iq. This parameter is active only in motor control mode flux vector induction (P35 [Motor Ctrl Mode] = 3 "Induction FV").	Default: Min/Max:	0.0000 –/+1.0000	RW	Real
		1618	<b>755 IdCompRegen 3 Iq</b> Id Compensation Regen 3 Iq Sets Iq value (in p.u.) at which P1617 [Id Comp Regen 3] (in p.u.) is specified. This parameter is active only in motor control mode flux vector induction (P35 [Motor Ctrl Mode] = 3 "Induction FV").	Default: Min/Max:	0.7500 0.0000 / 5.0000	RW	Real
		1619	<b>755 Id Comp Regen 4</b> Id Compensation Regen 4 Sets Id compensation value (in p.u.) at Iq = P1620 [IdCompRegen 4 Iq] (in p.u.) for regenerative operation. Id compensation = Id Comp Regen 3 + (Id Comp Regen 4 – Id Comp Regen 3) x (IqCmd – IdCompRegen 3 Iq) x 1/(IdCompRegen 4 Iq – IdCompRegen 3 Iq) for IqCmd = between IdCompRegen 3 Iq and IdCompRegen 4 Iq. This parameter is active only in motor control mode flux vector induction (P35 [Motor Ctrl Mode] = 3 "Induction FV").	Default: Min/Max:	0.0000 –/+1.0000	RW	Real
		1620	<b>755 IdCompRegen 4 Iq</b> Id Compensation Regen 4 Iq Sets Iq value (in p.u.) at which P1619 [Id Comp Regen 4] (in p.u.) is specified. This parameter is active only in motor control mode flux vector induction (P35 [Motor Ctrl Mode] = 3 "Induction FV").	Default: Min/Max:	1.0000 0.0000 / 5.0000	RW	Real
		1621	<b>755 Id Comp Regen 5</b> Id Compensation Regen 5 Sets Id compensation value (in p.u.) at Iq = P1622 [IdCompRegen 5 Iq] (in p.u.) for regenerative operation. Id compensation = Id Comp Regen 4 + (Id Comp Regen 5 – Id Comp Regen 4) x (IqCmd – IdCompRegen 4 Iq) x 1/(IdCompRegen 5 Iq – IdCompRegen 4 Iq) for IqCmd = between IdCompRegen 4 Iq and IdCompRegen 5 Iq. This parameter is active only in motor control mode flux vector induction (P35 [Motor Ctrl Mode] = 3 "Induction FV").	Default: Min/Max:	0.0000 –/+1.0000	RW	Real
		1622	<b>755 IdCompRegen 5 Iq</b> Id Compensation Regen 5 Iq Sets Iq value (in p.u.) at which P1621 [Id Comp Regen 5] (in p.u.) is specified. This parameter is active only in motor control mode flux vector induction (P35 [Motor Ctrl Mode] = 3 "Induction FV").	Default: Min/Max:	1.2500 0.0000 / 5.0000	RW	Real

File	Group	No.	Display Name Full Name Description	Values		Read-Write	Data Type
				Default:	Min/Max:		
APPLICATIONS	Id Compensation	1623	<b>755 Id Comp Regen 6</b> Id Compensation Regen 6 Sets Id compensation value (in p.u.) at $I_q = P1624$ [IdCompRegen 6 Iq] (in p.u.) for regenerative operation. Id compensation = Id Comp Regen 5 + (Id Comp Regen 6 – Id Comp Regen 5) x (IqCmd - IdCompRegen 5 Iq) x 1/(IdCompRegen 6 Iq – IdCompRegen 5 Iq) for IqCmd = between IdCompRegen 5 Iq and IdCompRegen 6 Iq. This parameter is active only in motor control mode flux vector induction (P35 [Motor Ctrl Mode] = 3 “Induction FV”).	0.0000	-/+1.0000	RW	Real
		1624	<b>755 IdCompRegen 6 Iq</b> Id Compensation Regen 6 Iq Sets Iq value (in p.u.) at which P1623 [Id Comp Regen 6] (in p.u.) is specified. This parameter is active only in motor control mode flux vector induction (P35 [Motor Ctrl Mode] = 3 “Induction FV”).	1.5000	0.0000 / 5.0000	RW	Real

	1629	See <a href="#">page 69</a> for parameter numbers 1629 and 1637...1645.
	1630	See <a href="#">page 66</a> for parameter numbers 1630...1636, 1646, and 1647.
	1648	See <a href="#">page 60</a> for parameter numbers 1648...1662

	1700	See <a href="#">page 160</a> for parameter numbers 1700...1731.
	1800	See <a href="#">page 160</a> for parameter numbers 1800...1831.
	1900	See <a href="#">page 160</a> for parameter numbers 1900, 1904, 1908, 1912, 1916, 1920, 1924, and 1928.
	1901	See <a href="#">page 160</a> for parameter numbers 1901, 1905, 1909, 1913, 1917, 1921, 1925, and 1929.
	1902	See <a href="#">page 160</a> for parameter numbers 1902, 1906, 1910, 1914, 1918, 1922, 1926, and 1930.
	1903	See <a href="#">page 160</a> for parameter numbers 1903, 1907, 1911, 1915, 1919, 1923, 1927, and 1931.

---

## Port 10 and Port 11 Parameters

This chapter lists and describes the PowerFlex 750-Series Port 10 and 11 drive parameters. The parameters can be programmed (viewed/edited) using a Human Interface Module (HIM). Refer to PowerFlex 20-HIM-A6 and 20-HIM-C6S HIM (Human Interface Module) User Manual, publication [20HIM-UM001](#), for information on using the HIM to view and edit parameters. As an alternative, programming can also be performed using DriveTools™ software and a personal computer.

Topic	Page
Inverter (Port 10) Common Parameters	222
Inverter n (Port 10) Parameters	224
Converter (Port 11) Common Parameters	227
Converter n (Port 11) Parameters	229
Precharge (Port 11) Common Parameters	232
Precharge n (Port 11) Parameters	234

## Inverter (Port 10) Common Parameters


Inverter Common parameters apply only to PowerFlex 755 Frame 8 and larger drives.

File	Group	No.	Display Name Full Name Description	Values	Read-Write	Data Type
INVERTER COMMON	System Ratings	1	<b>755 (8+) Sys Rated Amps</b> System Rated Amps Displays the continuous current rating of the drive. This parameter is the same value as displayed in P21 [Rated Amps] for the drive at Port 0.	Units: Amps Default: 0.00 Min/Max: 0.00 / Dependent on Frame Rating	RO	Real
		2	<b>755 (8+) Sys Rated Volts</b> System Rated Volts Input voltage class (400, 480, 600, 690, etc) of the drive. This parameter is the same value as displayed in P20 [Rated Volts] for the drive at Port 0.	Units: V AC Default: 0.00 Min/Max: 0.00 / 690.00	RO	Real
		3	<b>755 (8+) I1 Rated Amps</b>	Units: Amps Default: 0.00	RO	Real
		4	<b>755 (8+) I2 Rated Amps</b>	Default: 0.00		
		5	<b>755 (8+) I3 Rated Amps</b> Inverter <i>n</i> Rated Amps Continuous current rating of inverter <i>n</i> . The continuous current rating varies based on the value of P305 [Voltage Class] and P306 [Duty Rating] for the drive at Port 0.	Min/Max: 0.00 / 1000.00		
21	<b>755 (8+) Effctv I Rating</b> Effective Inverter Rating Sets the effective inverter current rating. During N-1 operation, the effective inverter current rating is reduced from P21 [Rated Amps].	Units: Amps Default: 0.0 Min/Max: 0.0 / Dependent on Frame Rating	RO	Real		

File	Group	No.	Display Name Full Name Description	Values	Read-Write	Data Type
INVERTER COMMON	Status	10	<b>755 (8+) Online Status</b> Online Status Indicates whether the inverter has successfully established fiber optic communications with the main control board.	Options Reserved Reserved Reserved Reserved Reserved Reserved Reserved Reserved Reserved Reserved Reserved Reserved Reserved Reserved Reserved Inverter 2 Inverter 1 Default 0 0 0 0 0 0 0 0 0 0 0 0 0 0 0 0 0 0 Bit 15 14 13 12 11 10 9 8 7 6 5 4 3 2 1 0	RO	16-bit Integer
		12	<b>755 (8+) Fault Status</b> Fault Status Indicates whether the inverter has a fault condition. See P105 [I1 Fault Status] to view which fault conditions currently exist for inverter 1. Refer to <a href="#">Chapter 6</a> for information on fault and alarm codes.	Options Reserved Reserved Reserved Reserved Reserved Reserved Reserved Reserved Reserved Reserved Reserved Reserved Reserved Reserved Reserved Inverter 2 Inverter 1 Default 0 0 0 0 0 0 0 0 0 0 0 0 0 0 0 0 0 0 Bit 15 14 13 12 11 10 9 8 7 6 5 4 3 2 1 0	RO	16-bit Integer

File	Group	No.	Display Name Full Name Description	Values	Read-Write	Data Type																																																	
INVERTER COMMON	Status	13	<b>755 (8+) Alarm Status</b> Alarm Status Indicates whether the inverter has an alarm condition. See P107 [I1 Alarm Status] to view which alarms currently exist for inverter 1. Refer to <a href="#">Chapter 6</a> for information on fault and alarm codes.  Options <table border="1" style="display: inline-table; vertical-align: middle;"> <tr> <td>Reserved</td><td>Reserved</td><td>Reserved</td><td>Reserved</td><td>Reserved</td><td>Reserved</td><td>Reserved</td><td>Reserved</td><td>Reserved</td><td>Reserved</td><td>Reserved</td><td>Reserved</td><td>Reserved</td><td>Reserved</td><td>Inverter 2</td><td>Inverter 1</td> </tr> <tr> <td>Default</td><td>0</td><td>0</td><td>0</td><td>0</td><td>0</td><td>0</td><td>0</td><td>0</td><td>0</td><td>0</td><td>0</td><td>0</td><td>0</td><td>0</td><td>0</td> </tr> <tr> <td>Bit</td><td>15</td><td>14</td><td>13</td><td>12</td><td>11</td><td>10</td><td>9</td><td>8</td><td>7</td><td>6</td><td>5</td><td>4</td><td>3</td><td>2</td><td>1</td><td>0</td> </tr> </table>	Reserved	Reserved	Reserved	Reserved	Reserved	Reserved	Reserved	Reserved	Reserved	Reserved	Reserved	Reserved	Reserved	Reserved	Inverter 2	Inverter 1	Default	0	0	0	0	0	0	0	0	0	0	0	0	0	0	0	Bit	15	14	13	12	11	10	9	8	7	6	5	4	3	2	1	0	0 = No Alarm 1 = Alarm	RO	16-bit Integer
		Reserved	Reserved	Reserved	Reserved	Reserved	Reserved	Reserved	Reserved	Reserved	Reserved	Reserved	Reserved	Reserved	Reserved	Inverter 2	Inverter 1																																						
Default	0	0	0	0	0	0	0	0	0	0	0	0	0	0	0																																								
Bit	15	14	13	12	11	10	9	8	7	6	5	4	3	2	1	0																																							

File	Group	No.	Display Name Full Name Description	Values	Read-Write	Data Type
INVERTER COMMON	Metering	18	<b>755 (8+) Ground Current</b> Ground Current Ground current of AC output to a motor. This value is calculated based on the total output currents (U, V, and W phases of the drive). When the three phases are balanced, the ground current is ideally close to zero.	Units: Amps Default: 0.0 Min/Max: 0.0 / 5000.0	RO	Real

File	Group	No.	Display Name Full Name Description	Values	Read-Write	Data Type
INVERTER COMMON	Configuration	20	<b>755 (8+) Recfg Acknowledg</b>  Reconfiguration Acknowledgement Acknowledge drive re-configuration for N-1 operation or drive rating change. Set to 1 "Acknowledge" (1) – Clears fault F361 "N-1 See Manual" and fault F362 "Rerate See Manual."	Default: 0 = "Ready" Options: 0 = "Ready" 1 = "Acknowledge"	RW	32-bit Integer

		21	See <a href="#">page 222</a> .			
--	--	----	--------------------------------	--	--	--

File	Group	No.	Display Name Full Name Description	Values	Read-Write	Data Type
INVERTER COMMON	Testpoints	30	<b>755 (8+) Testpoint Sel 1</b>	Default: 0	RW	32-bit Integer
		32	<b>755 (8+) Testpoint Sel 2</b> Testpoint Selection 1, 2 Selects a source for [Testpoint Val n]. Used by the factory, typically for diagnostic purposes.	Min/Max: 0 / 65535		
		31	<b>755 (8+) Testpoint Val 1</b>	Default: 0.000000	RO	Real
		33	<b>755 (8+) Testpoint Val 2</b> Testpoint Value 1, 2 Displays data selected by [Testpoint Sel n].	Min/Max: -/+220000000.000000		

# Inverter *n* (Port 10) Parameters

Inverter *n* parameters apply only to PowerFlex 755 Frame 8 and larger drives.

File	Group	No.	Display Name Full Name Description	Values	Read-Write	Data Type																														
INVERTER N	Status	105	<b>755 (8+)</b> I1 Fault Status		RO	32-bit Integer																														
		205	<b>755 (8+)</b> I2 Fault Status																																	
		305	<b>755 (8+)</b> I3 Fault Status																																	
		Inverter <i>n</i> Fault Status			Indicates which fault conditions currently exist for inverter <i>n</i> . Refer to <a href="#">Chapter 6</a> - Inverter (Port 10) Faults and Alarms (Frame 8 and Larger) for information on these fault codes.																															
		Options			Reserved	Reserved	WBrd Fault	VBrd Fault	UBrd Fault	Incompat PS	DC Bus Imbal	Incomp Brdn	Incomp WBrd	Incomp VBrd	Incomp UBrd	NTC Open	PSBrdOvrTemp	PLI OvrTemp	CT Hamess	SysPSOverCur	Sys PS Low	IPwrIF PSLow	Main PS Low	HS OvrTemp	IGBT OvrTemp	Ground Fault	Bus Overvolt	Overcur WNeg	Overcur WPos	Overcur VNeg	Overcur VPos	Overcur UNeg	Overcur UPos	ThermalConst	Comm Loss	Fault Q Full
		Default			0	0	0	0	0	0	0	0	0	0	0	0	0	0	0	0	0	0	0	0	0	0	0	0	0	0	0	0	0	0	0	
		Bit			31	30	29	28	27	26	25	24	23	22	21	20	19	18	17	16	15	14	13	12	11	10	9	8	7	6	5	4	3	2	1	0
					0 = No Fault 1 = Fault																															
		107	<b>755 (8+)</b> I1 Alarm Status		RO	32-bit Integer																														
		207	<b>755 (8+)</b> I2 Alarm Status																																	
307	<b>755 (8+)</b> I3 Alarm Status																																			
Inverter <i>n</i> Alarm Status			Indicates which alarm conditions currently exist for inverter <i>n</i> . Refer to <a href="#">Chapter 6</a> - Inverter (Port 10) Faults and Alarms (Frame 8 and Larger) for information on these alarm codes.																																	
Options			Reserved	Reserved	Reserved	Reserved	Reserved	Reserved	Reserved	Reserved	Reserved	Reserved	Reserved	Reserved	Reserved	Reserved	Reserved	Reserved	Reserved	Reserved	Reserved	Reserved	HSFan Slow	HSFan PS Low	Cur Offset W	Cur Offset V	Cur Offset U	Reserved	HS OvrTemp	IGBT OvrTemp	DC Bus Imbal	Infan2 Slow	Infan1 Slow	Sys PS Low	Reserved	
Default			0	0	0	0	0	0	0	0	0	0	0	0	0	0	0	0	0	0	0	0	0	0	0	0	0	0	0	0	0	0	0	0	0	0
Bit			31	30	29	28	27	26	25	24	23	22	21	20	19	18	17	16	15	14	13	12	11	10	9	8	7	6	5	4	3	2	1	0		
			0 = No Alarm 1 = Alarm																																	



File	Group	No.	Display Name Full Name Description	Values	Read-Write	Data Type
INVERTER N	Metering	115	755 (8+) I1 U Phase Curr	Units: Amps Default: 0.0 Min/Max: -/+3000.0	RO	Real
		215	755 (8+) I2 U Phase Curr			
		315	755 (8+) I3 U Phase Curr Inverter <i>n</i> U Phase Current Output current present through terminal T1 (U phase) of inverter <i>n</i> .			
		116	755 (8+) I1 V Phase Curr	Units: Amps Default: 0.0 Min/Max: -/+3000.0	RO	Real
		216	755 (8+) I2 V Phase Curr			
		316	755 (8+) I3 V Phase Curr Inverter <i>n</i> V Phase Current Output current present through terminal T2 (V phase) of inverter <i>n</i> .			
		117	755 (8+) I1 W Phase Curr	Units: Amps Default: 0.0 Min/Max: -/+3000.0	RO	Real
		217	755 (8+) I2 W Phase Curr			
		317	755 (8+) I3 W Phase Curr Inverter <i>n</i> W Phase Current Output current present through terminal T3 (W phase) of inverter <i>n</i> .			
		118	755 (8+) I1 Gnd Current	Units: Amps Default: 0.0 Min/Max: -/+3000.0	RO	Real
		218	755 (8+) I2 Gnd Current			
		318	755 (8+) I3 Gnd Current Inverter <i>n</i> Ground Current Ground current of the AC output to a motor. The value is calculated based on the output currents (U, V, and W phases) for inverter <i>n</i> . When the three phases are balanced, the ground current is ideally close to zero.			
		119	755 (8+) I1 DC Bus Volt	Units: V DC Default: 0.00 Min/Max: 0.00 / 1200.00	RO	Real
		219	755 (8+) I2 DC Bus Volt			
		319	755 (8+) I3 DC Bus Volt Inverter <i>n</i> DC Bus Voltage DC bus voltage measured by inverter <i>n</i> .			
		120	755 (8+) I1 Heatsink Temp	Units: DegC Default: 0.0 Min/Max: -/+200.0	RO	Real
		220	755 (8+) I2 Heatsink Temp			
		320	755 (8+) I3 Heatsink Temp Inverter <i>n</i> Heatsink Temperature Temperature of the heatsink for inverter <i>n</i> .			
121	755 (8+) I1 IGBT Temp	Units: DegC Default: 0.0 Min/Max: -/+200.0	RO	Real		
221	755 (8+) I2 IGBT Temp					
321	755 (8+) I3 IGBT Temp Inverter <i>n</i> IGBT Temperature IGBT junction temperature of inverter <i>n</i> .					
124	755 (8+) I1 HSFan Speed	Units: RPM Default: 0.0 Min/Max: 0.0 / 7200.0	RO	Real		
224	755 (8+) I2 HSFan Speed					
324	755 (8+) I3 HSFan Speed Inverter <i>n</i> Heatsink Fan Speed The measured speed of the heatsink fan for inverter <i>n</i> .					
125	755 (8+) I1 InFan 1 Speed	Units: RPM Default: 0.0 Min/Max: 0.0 / 7200.0	RO	Real		
225	755 (8+) I2 InFan 1 Speed					
325	755 (8+) I3 InFan 1 Speed Inverter <i>n</i> Internal Fan 1 Speed The measured speed of the capacitor bank internal stirring fan 1 for inverter <i>n</i> .					
126	755 (8+) I1 InFan 2 Speed	Units: RPM Default: 0.0 Min/Max: 0.0 / 7200.0	RO	Real		
226	755 (8+) I2 InFan 2 Speed					
326	755 (8+) I3 InFan 2 Speed Inverter <i>n</i> Internal Fan 2 Speed The measured speed of the capacitor bank internal stirring fan 2 for inverter <i>n</i> .					

File	Group	No.	Display Name Full Name Description	Values	Read-Write	Data Type			
INVERTER N	Predictive Main	127	<b>I1 PredMainReset</b>	Default: 0 = "Ready" Options: 0 = "Ready" 1 = "HS Fan Life" 2 = "In Fan Life"	RW	32-bit Integer			
		227	<b>I2 PredMainReset</b>						
		327	<b>I3 PredMainReset</b>						
			Inverter <i>n</i> Predictive Maintenance Reset						
		Allows a reset of the elapsed run time to zero for either the heatsink fan or internal stirring fans for inverter <i>n</i> . After the time has been reset, the value of this parameter returns to 0 "Ready." "Hs Fan Life" (1) – Resets the elapsed run time (displayed in [In HSFanElpsdLif]) for the heatsink fan on inverter <i>n</i> to zero. "In Fan Life" (2) – Resets the elapsed run time (displayed in [In InFanElpsdLif]) for the internal stirring fans on inverter <i>n</i> to zero.							
		128	<b>I1 HSFanElpsdLif</b>				Units: Hrs Default: 0.00 Min/Max: 0.00 / 220000000.00	RO	Real
		228	<b>I2 HSFanElpsdLif</b>						
		328	<b>I3 HSFanElpsdLif</b>						
		Inverter <i>n</i> Heatsink Fan Elapsed Life The amount of time the heat sink fan on inverter <i>n</i> has been running. This value can be reset using [In PredMainReset].							
		129	<b>I1 InFanElpsdLif</b>				Units: Hrs Default: 0.00 Min/Max: 0.00 / 220000000.00	RO	Real
229	<b>I2 InFanElpsdLif</b>								
329	<b>I3 InFanElpsdLif</b>								
Inverter <i>n</i> Internal Fan Elapsed Life The amount of time the inverter stirring fans on inverter <i>n</i> have been running. This value can be reset using [In PredMainReset].									

File	Group	No.	Display Name Full Name Description	Values	Read-Write	Data Type
INVERTER N	Testpoints	140	<b>I1 Testpt Sel 1</b>	Default: 0 Min/Max: 0 / 65535	RW	32-bit Integer
		142	<b>I1 Testpt Sel 2</b>			
		240	<b>I2 Testpt Sel 1</b>			
		242	<b>I2 Testpt Sel 2</b>			
		340	<b>I3 Testpt Sel 1</b>			
		342	<b>I3 Testpt Sel 2</b>			
		Inverter <i>n</i> Testpoint Selection 1, 2 Selects a source for [In Testpt Val <i>n</i> ]. Used by the factory, typically for diagnostic purposes.				
		141	<b>I1 Testpt Val 1</b>	Default: 0.000000 Min/Max: -/+220000000.000000	RO	Real
		143	<b>I1 Testpt Val 2</b>			
		241	<b>I2 Testpt Val 1</b>			
		243	<b>I2 Testpt Val 2</b>			
		341	<b>I3 Testpt Val 1</b>			
		343	<b>I3 Testpt Val 2</b>			
		Inverter <i>n</i> Testpoint Value 1, 2 Displays the data selected by [In Testpt Sel <i>n</i> ].				

## Converter (Port 11) Common Parameters

Converter Common parameters apply only to PowerFlex 755 AC Input Frame 8 and larger drives.

File	Group	No.	Display Name Full Name Description	Values	Read-Write	Data Type
CONVERTER COMMON	System Ratings	1	<b>755 (8+) Sys Rated Amps</b> System Rated Amps Displays the continuous current rating of the converter system.	Units: Amps Default: 0.00 Min/Max: 0.00 / Dependent on Frame Rating	RO	Real
		2	<b>755 (8+) Sys Rated Volts</b> System Volts Input voltage class (400, 480, 600, 690, etc) of the converter system.	Units: V AC Default: 0.00 Min/Max: 0.00 / 690.00	RO	Real
		3	<b>755 (8+) C1 Rated Amps</b>	Units: Amps	RO	Real
		4	<b>755 (8+) C2 Rated Amps</b>	Default: 0.00		
		5	<b>755 (8+) C3 Rated Amps</b> Converter <i>n</i> Rated Amps Continuous current rating of converter <i>n</i> . Used with AC Input drives.	Min/Max: 0.00 / 3000.00		

File	Group	No.	Display Name Full Name Description	Values	Read-Write	Data Type
CONVERTER COMMON	Status	10	<b>755 (8+) Online Status</b> Online Status Indicates whether the converter has successfully established fiber optic communications with the main control board.  Options Reserved Reserved Reserved Reserved Reserved Reserved Reserved Reserved Reserved Reserved Reserved Reserved Reserved Reserved Converter 2 Converter 1 Default 0 0 0 0 0 0 0 0 0 0 0 0 0 0 0 0 Bit 15 14 13 12 11 10 9 8 7 6 5 4 3 2 1 0	0 = Not Active 1 = Active	RO	16-bit Integer
		12	<b>755 (8+) Fault Status</b> Fault Status Indicates whether the converter has a fault condition. See [C <i>n</i> Fault Status <i>n</i> ] to view which fault conditions currently exist for converter <i>n</i> .  Options Reserved Reserved Reserved Reserved Reserved Reserved Reserved Reserved Reserved Reserved Reserved Reserved Reserved Reserved Converter 2 Converter 1 Default 0 0 0 0 0 0 0 0 0 0 0 0 0 0 0 0 Bit 15 14 13 12 11 10 9 8 7 6 5 4 3 2 1 0	0 = No Fault 1 = Fault	RO	16-bit Integer
		13	<b>755 (8+) Alarm Status</b> Alarm Status Indicates whether the converter has an alarm condition. See [C <i>n</i> Alarm Status <i>n</i> ] to view which alarms currently exist for converter <i>n</i> .  Options Reserved Reserved Reserved Reserved Reserved Reserved Reserved Reserved Reserved Reserved Reserved Reserved Reserved Reserved Converter 2 Converter 1 Default 0 0 0 0 0 0 0 0 0 0 0 0 0 0 0 0 Bit 15 14 13 12 11 10 9 8 7 6 5 4 3 2 1 0	0 = No Alarm 1 = Alarm	RO	16-bit Integer

File	Group	No.	Display Name Full Name Description	Values	Read-Write	Data Type
CONVERTER COMMON	Configuration	16	<b>755 (8+) Gnd Cur Flt Lvl</b> Ground Current Fault Level The converter system peak ground current fault threshold. The converter will fault if the peak input ground current exceeds this threshold for five line cycles on any converter.	Units: Amps Default: 600.0 Min/Max: 0.0 / 3000.0	RW	Real
		17	<b>755 (8+) Converter Actn</b> Converter Action The action the inverter takes when a converter fault occurs.	Default: 3 Options: 0 = "Ignore" 1 = "Reserved" 2 = "Minor Stop" 3 = "Coast Stop" 4 = "Ramp Stop" 5 = "Cur Lmt Stop"	RW	Integer

File	Group	No.	Display Name Full Name Description	Values	Read-Write	Data Type
CONVERTER COMMON	Metering	20	<b>755 (8+) L1 Phase Curr</b> Line 1 Phase Current The converter system AC line 1 (R) RMS input current. This is the sum of all line 1 (R) phase currents from all online converters.	Units: Amps Default: 0.0 Min/Max: 0.0 / 15000.0	RO	Real
		21	<b>755 (8+) L2 Phase Curr</b> Line 2 Phase Current The converter system AC line 2 (S) RMS input current. This is the sum of all line 2 (S) phase currents from all online converters.	Units: Amps Default: 0.0 Min/Max: 0.0 / 15000.0	RO	Real
		22	<b>755 (8+) L3 Phase Curr</b> Line 3 Phase Current The converter system AC line 3 (T) RMS input current. This is the sum of all line 3 (T) phase currents from all online converters.	Units: Amps Default: 0.0 Min/Max: 0.0 / 15000.0	RO	Real
		23	<b>755 (8+) Heatsink Temp</b> Heatsink Temperature The converter system heatsink temperature. This is the maximum heatsink temperature from all online converters.	Units: DegC Default: 0.0 Min/Max: -/+200.0	RO	Real
		24	<b>755 (8+) SCR Temp</b> SCR Temperature The converter system SCR temperature. This is the maximum SCR temperature from all online converters.	Units: DegC Default: 0.0 Min/Max: -/+200.0	RO	Real
		25	<b>755 (8+) Gate Board Temp</b> Gate Board Temperature The converter system gate board temperature. This is the maximum gate board temperature from all online converters	Units: DegC Default: 0.0 Min/Max: -/+200.0	RO	Real
CONVERTER COMMON	Testpoints	30	<b>755 (8+) Testpoint Sel 1</b>	Default: 0	RW	32-bit Integer
		32	<b>755 (8+) Testpoint Sel 2</b> Testpoint Selection 1, 2 Selects a source for [Testpoint Val <i>n</i> ]. Used by the factory, typically for diagnostic purposes.	Min/Max: 0 / 65535		
		31	<b>755 (8+) Testpoint Val 1</b>	Default: 0.000000	RO	Real
33	<b>755 (8+) Testpoint Val 2</b> Testpoint Value 1, 2 Displays data selected by [Testpoint Sel <i>n</i> ].	Min/Max: -/+220000000.000000				

# Converter *n* (Port 11) Parameters

Converter *n* parameters apply only to PowerFlex 755 AC Input Frame 8 and larger drives.

File	Group	No.	Display Name Full Name Description	Values	Read-Write	Data Type																																																																																																													
CONVERTER N	Status	105	755 (8+) C1 Fault Status1	Converter <i>n</i> Fault Status 1 Indicates which fault conditions currently exist for converter <i>n</i> . Refer to <a href="#">Chapter 6</a> - Converter (Port 11) Faults and Alarms (Frame 8 and Larger) for information on these fault codes.  Options <table border="1"> <tr> <td>Reserved</td><td>BFuseHarn</td><td>Reserved</td><td>Reserved</td><td>Reserved</td><td>Reserved</td><td>Reserved</td><td>Reserved</td><td>Reserved</td><td>Line Fuse L3</td><td>Line Fuse L2</td><td>Line Fuse L1</td><td>LFuseHarn</td><td>CT Harn</td><td>DC Bus Short</td><td>DC Bus Open</td><td>Firmware Fit</td><td>Comm Loss</td><td>Power Supply</td><td>Brd NTCShort</td><td>Brd NTC Open</td><td>Brd OvrTemp</td><td>HS NTC Short</td><td>HS NTC Open</td><td>Ground Fault</td><td>Overcurrent</td><td>Single Phase</td><td>Line Freq</td><td>Line Dip</td><td>HS OvrTemp</td><td>SCR OvrTemp</td><td>Precharge</td><td>Fault Q Full</td> </tr> <tr> <td>0</td><td>0</td><td>0</td><td>0</td><td>0</td><td>0</td><td>0</td><td>0</td><td>0</td><td>0</td><td>0</td><td>0</td><td>0</td><td>0</td><td>0</td><td>0</td><td>0</td><td>0</td><td>0</td><td>0</td><td>0</td><td>0</td><td>0</td><td>0</td><td>0</td><td>0</td><td>0</td><td>0</td><td>0</td><td>0</td><td>0</td><td>0</td> </tr> <tr> <td>31</td><td>30</td><td>29</td><td>28</td><td>27</td><td>26</td><td>25</td><td>24</td><td>23</td><td>22</td><td>21</td><td>20</td><td>19</td><td>18</td><td>17</td><td>16</td><td>15</td><td>14</td><td>13</td><td>12</td><td>11</td><td>10</td><td>9</td><td>8</td><td>7</td><td>6</td><td>5</td><td>4</td><td>3</td><td>2</td><td>1</td><td>0</td> </tr> </table> 0 = False 1 = True	Reserved	BFuseHarn	Reserved	Reserved	Reserved	Reserved	Reserved	Reserved	Reserved	Line Fuse L3	Line Fuse L2	Line Fuse L1	LFuseHarn	CT Harn	DC Bus Short	DC Bus Open	Firmware Fit	Comm Loss	Power Supply	Brd NTCShort	Brd NTC Open	Brd OvrTemp	HS NTC Short	HS NTC Open	Ground Fault	Overcurrent	Single Phase	Line Freq	Line Dip	HS OvrTemp	SCR OvrTemp	Precharge	Fault Q Full	0	0	0	0	0	0	0	0	0	0	0	0	0	0	0	0	0	0	0	0	0	0	0	0	0	0	0	0	0	0	0	0	31	30	29	28	27	26	25	24	23	22	21	20	19	18	17	16	15	14	13	12	11	10	9	8	7	6	5	4	3	2	1	0	RO	32-bit Integer												
		Reserved	BFuseHarn		Reserved	Reserved	Reserved	Reserved	Reserved	Reserved	Reserved	Line Fuse L3	Line Fuse L2	Line Fuse L1	LFuseHarn	CT Harn	DC Bus Short	DC Bus Open	Firmware Fit	Comm Loss	Power Supply	Brd NTCShort	Brd NTC Open	Brd OvrTemp	HS NTC Short	HS NTC Open	Ground Fault	Overcurrent	Single Phase	Line Freq	Line Dip	HS OvrTemp	SCR OvrTemp	Precharge	Fault Q Full																																																																																
		0	0		0	0	0	0	0	0	0	0	0	0	0	0	0	0	0	0	0	0	0	0	0	0	0	0	0	0	0	0	0	0																																																																																	
		31	30		29	28	27	26	25	24	23	22	21	20	19	18	17	16	15	14	13	12	11	10	9	8	7	6	5	4	3	2	1	0																																																																																	
		205	755 (8+) C2 Fault Status1																																																																																																																
		305	755 (8+) C3 Fault Status1																																																																																																																
		106	755 (8+) C1 Fault Status2		Converter <i>n</i> Fault Status 2 Indicates which fault conditions currently exist for converter <i>n</i> . Refer to <a href="#">Chapter 6</a> - Converter (Port 11) Faults and Alarms (Frame 8 and Larger) for information on these fault codes.  Options <table border="1"> <tr> <td>Reserved</td><td>Reserved</td><td>Reserved</td><td>Reserved</td><td>Reserved</td><td>Reserved</td><td>Reserved</td><td>Reserved</td><td>Reserved</td><td>Reserved</td><td>Reserved</td><td>Reserved</td><td>Reserved</td><td>Reserved</td><td>Reserved</td><td>Reserved</td><td>Reserved</td><td>Reserved</td><td>Reserved</td><td>Reserved</td><td>Reserved</td><td>Reserved</td><td>Reserved</td><td>Reserved</td><td>Reserved</td><td>Reserved</td><td>Reserved</td><td>Reserved</td><td>Reserved</td><td>Reserved</td><td>Reserved</td><td>Line Loss</td><td>AC Line High</td><td>Command Stop</td><td>BFuse Neg</td><td>BFuse Pos</td> </tr> <tr> <td>0</td><td>0</td><td>0</td><td>0</td><td>0</td><td>0</td><td>0</td><td>0</td><td>0</td><td>0</td><td>0</td><td>0</td><td>0</td><td>0</td><td>0</td><td>0</td><td>0</td><td>0</td><td>0</td><td>0</td><td>0</td><td>0</td><td>0</td><td>0</td><td>0</td><td>0</td><td>0</td><td>0</td><td>0</td><td>0</td><td>0</td><td>0</td><td>0</td><td>0</td><td>0</td><td>0</td> </tr> <tr> <td>31</td><td>30</td><td>29</td><td>28</td><td>27</td><td>26</td><td>25</td><td>24</td><td>23</td><td>22</td><td>21</td><td>20</td><td>19</td><td>18</td><td>17</td><td>16</td><td>15</td><td>14</td><td>13</td><td>12</td><td>11</td><td>10</td><td>9</td><td>8</td><td>7</td><td>6</td><td>5</td><td>4</td><td>3</td><td>2</td><td>1</td><td>0</td><td>0</td><td>0</td><td>0</td><td>0</td> </tr> </table> 0 = False 1 = True	Reserved	Reserved	Reserved	Reserved	Reserved	Reserved	Reserved	Reserved	Reserved	Reserved	Reserved	Reserved	Reserved	Reserved	Reserved	Reserved	Reserved	Reserved	Reserved	Reserved	Reserved	Reserved	Reserved	Reserved	Reserved	Reserved	Reserved	Reserved	Reserved	Reserved	Reserved	Line Loss	AC Line High	Command Stop	BFuse Neg	BFuse Pos	0	0	0	0	0	0	0	0	0	0	0	0	0	0	0	0	0	0	0	0	0	0	0	0	0	0	0	0	0	0	0	0	0	0	0	0	31	30	29	28	27	26	25	24	23	22	21	20	19	18	17	16	15	14	13	12	11	10	9	8	7	6	5	4	3	2	1	0	0	0	0	0	RO	32-bit Integer
		Reserved	Reserved			Reserved	Reserved	Reserved	Reserved	Reserved	Reserved	Reserved	Reserved	Reserved	Reserved	Reserved	Reserved	Reserved	Reserved	Reserved	Reserved	Reserved	Reserved	Reserved	Reserved	Reserved	Reserved	Reserved	Reserved	Reserved	Reserved	Reserved	Reserved	Reserved	Line Loss	AC Line High	Command Stop	BFuse Neg	BFuse Pos																																																																												
		0	0			0	0	0	0	0	0	0	0	0	0	0	0	0	0	0	0	0	0	0	0	0	0	0	0	0	0	0	0	0	0	0	0	0	0																																																																												
		31	30			29	28	27	26	25	24	23	22	21	20	19	18	17	16	15	14	13	12	11	10	9	8	7	6	5	4	3	2	1	0	0	0	0	0																																																																												
206	755 (8+) C2 Fault Status2																																																																																																																		
306	755 (8+) C3 Fault Status2																																																																																																																		
107	755 (8+) C1 Alarm Status1	Converter <i>n</i> Alarm Status 1 Indicates which alarm conditions currently exist for converter <i>n</i> . Refer to <a href="#">Chapter 6</a> - Converter (Port 11) Faults and Alarms (Frame 8 and Larger) for information on these alarm codes.  Options <table border="1"> <tr> <td>Reserved</td><td>Reserved</td><td>Reserved</td><td>Reserved</td><td>Reserved</td><td>Reserved</td><td>Reserved</td><td>Reserved</td><td>Reserved</td><td>Reserved</td><td>Reserved</td><td>Reserved</td><td>Reserved</td><td>Reserved</td><td>Reserved</td><td>Reserved</td><td>Reserved</td><td>Reserved</td><td>Reserved</td><td>Reserved</td><td>Reserved</td><td>Reserved</td><td>Reserved</td><td>Reserved</td><td>Reserved</td><td>Reserved</td><td>Reserved</td><td>Reserved</td><td>Reserved</td><td>Reserved</td><td>Reserved</td><td>Reserved</td><td>Phase LossL3</td><td>Phase LossL2</td><td>Phase LossL1</td><td>Precharge</td> </tr> <tr> <td>0</td><td>0</td><td>0</td><td>0</td><td>0</td><td>0</td><td>0</td><td>0</td><td>0</td><td>0</td><td>0</td><td>0</td><td>0</td><td>0</td><td>0</td><td>0</td><td>0</td><td>0</td><td>0</td><td>0</td><td>0</td><td>0</td><td>0</td><td>0</td><td>0</td><td>0</td><td>0</td><td>0</td><td>0</td><td>0</td><td>0</td><td>0</td><td>0</td><td>0</td><td>0</td><td>0</td> </tr> <tr> <td>31</td><td>30</td><td>29</td><td>28</td><td>27</td><td>26</td><td>25</td><td>24</td><td>23</td><td>22</td><td>21</td><td>20</td><td>19</td><td>18</td><td>17</td><td>16</td><td>15</td><td>14</td><td>13</td><td>12</td><td>11</td><td>10</td><td>9</td><td>8</td><td>7</td><td>6</td><td>5</td><td>4</td><td>3</td><td>2</td><td>1</td><td>0</td><td>0</td><td>0</td><td>0</td><td>0</td> </tr> </table> 0 = False 1 = True	Reserved	Reserved		Reserved	Reserved	Reserved	Reserved	Reserved	Reserved	Reserved	Reserved	Reserved	Reserved	Reserved	Reserved	Reserved	Reserved	Reserved	Reserved	Reserved	Reserved	Reserved	Reserved	Reserved	Reserved	Reserved	Reserved	Reserved	Reserved	Reserved	Reserved	Reserved	Reserved	Phase LossL3	Phase LossL2	Phase LossL1	Precharge	0	0	0	0	0	0	0	0	0	0	0	0	0	0	0	0	0	0	0	0	0	0	0	0	0	0	0	0	0	0	0	0	0	0	0	0	31	30	29	28	27	26	25	24	23	22	21	20	19	18	17	16	15	14	13	12	11	10	9	8	7	6	5	4	3	2	1	0	0	0	0	0	RO	32-bit Integer		
Reserved	Reserved		Reserved	Reserved		Reserved	Reserved	Reserved	Reserved	Reserved	Reserved	Reserved	Reserved	Reserved	Reserved	Reserved	Reserved	Reserved	Reserved	Reserved	Reserved	Reserved	Reserved	Reserved	Reserved	Reserved	Reserved	Reserved	Reserved	Reserved	Reserved	Reserved	Reserved	Phase LossL3	Phase LossL2	Phase LossL1	Precharge																																																																														
0	0		0	0		0	0	0	0	0	0	0	0	0	0	0	0	0	0	0	0	0	0	0	0	0	0	0	0	0	0	0	0	0	0	0	0																																																																														
31	30		29	28		27	26	25	24	23	22	21	20	19	18	17	16	15	14	13	12	11	10	9	8	7	6	5	4	3	2	1	0	0	0	0	0																																																																														
207	755 (8+) C2 Alarm Status1																																																																																																																		
307	755 (8+) C3 Alarm Status1																																																																																																																		

File	Group	No.	Display Name Full Name Description	Values	Read-Write	Data Type
CONVERTER N	Metering	115	755 (8+) C1 L1 Phase Curr	Units: Amps Default: 0.0 Min/Max: -/+9000.0	RO	Real
		215	755 (8+) C2 L1 Phase Curr			
		315	755 (8+) C3 L1 Phase Curr Converter <i>n</i> Line 1 Phase Current Input current present at terminal L1 (R phase) of converter <i>n</i> .			
		116	755 (8+) C1 L2 Phase Curr	Units: Amps Default: 0.0 Min/Max: -/+9000.0	RO	Real
		216	755 (8+) C2 L2 Phase Curr			
		316	755 (8+) C3 L2 Phase Curr Converter <i>n</i> Line 2 Phase Current Input current present at terminal L2 (S phase) of converter <i>n</i> .			
		117	755 (8+) C1 L3 Phase Curr	Units: Amps Default: 0.0 Min/Max: -/+9000.0	RO	Real
		217	755 (8+) C2 L3 Phase Curr			
		317	755 (8+) C3 L3 Phase Curr Converter <i>n</i> Line 3 Phase Current Input current present at terminal L3 (T phase) of converter <i>n</i> .			
		118	755 (8+) C1 Gnd Current	Units: Amps Default: 0.0 Min/Max: -/+9000.0	RO	Real
		218	755 (8+) C2 Gnd Current			
		318	755 (8+) C3 Gnd Current Converter <i>n</i> Ground Current The RMS ground current of AC input to converter <i>n</i> . The value displayed is based on the sum of converter <i>n</i> drive input currents (L1, L2, and L3). When the three phases are balanced, the ground current is ideally close to zero.			
		119	755 (8+) C1 DC Bus Volt	Units: V DC Default: 0.0 Min/Max: 0.0 / 1200.0	RO	Real
		219	755 (8+) C2 DC Bus Volt			
		319	755 (8+) C3 DC Bus Volt Converter <i>n</i> DC Bus Voltage DC bus voltage measured by converter <i>n</i> .			
		120	755 (8+) C1 Heatsink Temp	Units: DegC Default: 0.0 Min/Max: -/+200.0	RO	Real
		220	755 (8+) C2 Heatsink Temp			
		320	755 (8+) C3 Heatsink Temp Converter <i>n</i> Heatsink Temperature Temperature of the converter <i>n</i> heatsink.			
		121	755 (8+) C1 SCR Temp	Units: DegC Default: 0.0 Min/Max: -/+200.0	RO	Real
		221	755 (8+) C2 SCR Temp			
		321	755 (8+) C3 SCR Temp Converter <i>n</i> SCR Frequency Maximum temperature of all SCRs for converter <i>n</i> .			
122	755 (8+) C1 GateBoardTemp	Units: DegC Default: 0.0 Min/Max: -/+200.0	RO	Real		
222	755 (8+) C2 GateBoardTemp					
322	755 (8+) C3 GateBoardTemp Converter <i>n</i> Gate Board Temperature Gate board temperature for converter <i>n</i> .					
123	755 (8+) C1 AC Line Freq	Units: Hz Default: 0.0 Min/Max: 0.0 / 100.0	RO	Real		
223	755 (8+) C2 AC Line Freq					
323	755 (8+) C3 AC Line Freq Converter <i>n</i> AC Line Frequency AC line frequency of converter <i>n</i> .					

File	Group	No.	Display Name Full Name Description	Values	Read-Write	Data Type	
CONVERTER N	Metering	125	<b>C1 L12 Line Volt</b>	Units: V AC Default: 0.0 Min/Max: 0.0 / 850.0	RO	Real	
		225	<b>C2 L12 Line Volt</b>				
		325	<b>C3 L12 Line Volt</b>				
		Converter <i>n</i> Line 1 to Line 2 Line Voltage The phase-to-phase RMS line voltage between L1 and L2 for converter <i>n</i> .					
		126	<b>C1 L23 Line Volt</b>	Units: V AC Default: 0.0 Min/Max: 0.0 / 850.0	RO	Real	
		226	<b>C2 L23 Line Volt</b>				
		326	<b>C3 L23 Line Volt</b>				
		Converter <i>n</i> Line 2 to Line 3 Line Voltage The phase-to-phase RMS line voltage between L2 and L3 for converter <i>n</i> .					
		127	<b>C1 L31 Line Volt</b>	Units: V AC Default: 0.0 Min/Max: 0.0 / 850.0	RO	Real	
227	<b>C2 L31 Line Volt</b>						
327	<b>C3 L31 Line Volt</b>						
Converter <i>n</i> Line 3 to Line 1 Line Voltage The phase-to-phase RMS line voltage between L3 and L1 for converter <i>n</i> .							

File	Group	No.	Display Name Full Name Description	Values	Read-Write	Data Type
CONVERTER N	Predictive Main	137	<b>C1 PredMainReset</b>	Default: 0 = "Ready" Options: 0 = "Ready" 1 = "Cb Fan Life"	RW	Real
		237	<b>C2 PredMainReset</b>			
		337	<b>C3 PredMainReset</b>			
			Converter <i>n</i> Predictive Maintenance Reset Allows a reset of the elapsed run time to zero for the cabinet fan for converter <i>n</i> . After the time has been reset, the value of this parameter returns to 0 "Ready."			
		138	<b>C1 CbFanElpsdLif</b>	Units: Hrs Default: 0.000 Min/Max: 0.000 / 2200000.000	RO	Real
		238	<b>C2 CbFanElpsdLif</b>			
338	<b>C3 CbFanElpsdLif</b>					
Converter <i>n</i> Cabinet Fan Elapsed Life The amount of time the cabinet fan for converter <i>n</i> has been running. This value can be reset using [ <i>Cn</i> PredMainReset].						

File	Group	No.	Display Name Full Name Description	Values	Read-Write	Data Type	
CONVERTER N	Testpoints	140	<b>C1 Testpt Sel 1</b>	Default: 0 Min/Max: 0 / 65535	RW	32-bit Integer	
		142	<b>C1 Testpt Sel 2</b>				
		240	<b>C2 Testpt Sel 1</b>				
		242	<b>C2 Testpt Sel 2</b>				
		340	<b>C3 Testpt Sel 1</b>				
		342	<b>C3 Testpt Sel 2</b>				
		Converter <i>n</i> Testpoint Selection 1, 2 Selects a source for [ <i>Cn</i> Testpt Val <i>n</i> ]. Used by the factory, typically for diagnostic purposes.					
		141	<b>C1 Testpt Val 1</b>	Default: 0.000000 Min/Max: -/+220.000000	RO	Real	
		143	<b>C1 Testpt Val 2</b>				
		241	<b>C2 Testpt Val 1</b>				
		243	<b>C2 Testpt Val 2</b>				
		341	<b>C3 Testpt Val 1</b>				
343	<b>C3 Testpt Val 2</b>						
Converter <i>n</i> Testpoint Value 1, 2 Displays the data selected by [ <i>Cn</i> Testpt Sel <i>n</i> ].							

## Precharge (Port 11) Common Parameters

Precharge Common parameters apply only to PowerFlex 755 Common DC Input Frame 8 and larger drives.

File	Group	No.	Display Name Full Name Description	Values	Read-Write	Data Type
PRECHARGE COMMON	System Ratings	1	<b>755 (8+) Sys Rated Amps</b> System Rated Amps Displays the continuous current rating of the precharge system.	Units: Amps Default: 0.00 Min/Max: 0.00 / 5000.00	RO	Real
		2	<b>755 (8+) Sys Rated Volts</b> System Volts Input voltage class (400, 480, 600, 690, etc) of the precharge system.	Units: V AC Default: 0.00 Min/Max: 0.00 / 690.00	RO	Real
		3	<b>755 (8+) P1 Rated Amps</b>	Units: Amps	RO	Real
		4	<b>755 (8+) P2 Rated Amps</b>	Default: 0.00		
		5	<b>755 (8+) P3 Rated Amps</b> Precharge <i>n</i> Rated Amps Continuous current rating of precharge unit <i>n</i> . Used with Common DC Input drives.	Min/Max: 0.00 / 3000.00		

File	Group	No.	Display Name Full Name Description	Values	Read-Write	Data Type	
PRECHARGE COMMON	Status	10	<b>755 (8+) Online Status</b> Online Status Indicates whether the precharge unit has successfully established fiber optic communications with the main control board.		RO	16-bit Integer	
		Options			Reserved Reserved Reserved Reserved Reserved Reserved Reserved Reserved Reserved Reserved Reserved Reserved Reserved Reserved Precharge 2 Precharge 1		
		Default	0 0 0 0 0 0 0 0 0 0 0 0 0 0 0 0	0 = Not Active 1 = Active			
		Bit	15 14 13 12 11 10 9 8 7 6 5 4 3 2 1 0				
		12	<b>755 (8+) Fault Status</b> Fault Status Indicates whether the precharge unit has a fault condition. See [P <i>n</i> Fault Status <i>n</i> ] and to view which fault conditions currently exist for precharge <i>n</i> .		RO	16-bit Integer	
Options			Reserved Reserved Reserved Reserved Reserved Reserved Reserved Reserved Reserved Reserved Reserved Reserved Reserved Reserved Precharge 2 Precharge 1				
		Default	0 0 0 0 0 0 0 0 0 0 0 0 0 0 0 0	0 = No Fault 1 = Fault			
		Bit	15 14 13 12 11 10 9 8 7 6 5 4 3 2 1 0				
		13	<b>755 (8+) Alarm Status</b> Alarm Status Indicates whether the precharge unit has an alarm condition. See [P <i>n</i> Alarm Status <i>n</i> ] to view which alarms currently exist for precharge <i>n</i> .		RO	16-bit Integer	
Options			Reserved Reserved Reserved Reserved Reserved Reserved Reserved Reserved Reserved Reserved Reserved Reserved Reserved Reserved Precharge 2 Precharge 1				
		Default	0 0 0 0 0 0 0 0 0 0 0 0 0 0 0 0	0 = No Alarm 1 = Alarm			
		Bit	15 14 13 12 11 10 9 8 7 6 5 4 3 2 1 0				



File	Group	No.	Display Name Full Name Description	Values	Read-Write	Data Type
PRECHARGE COMMON	Metering	18	<b>755 (8+) Main DC Bus Volt</b> Main DC Bus Voltage Sets the main DC bus voltage.	Units: V DC Default: 0.00 Min/Max: 0.00 / 1200.00	RW	Real
		25	<b>755 (8+) Gate Board Temp</b> Gate Board Temperature The precharge system gate board temperature. This is the maximum gate board temperature from all online precharge units.	Units: DegC Default: 0.0 Min/Max: -/+200.0	RO	Real

File	Group	No.	Display Name Full Name Description	Values	Read-Write	Data Type
PRECHARGE COMMON	Testpoints	30	<b>755 (8+) Testpoint Sel 1</b>	Default: 0	RW	32-bit Integer
		32	<b>755 (8+) Testpoint Sel 2</b> Testpoint Selection 1, 2 Selects a source for [Testpoint Val <i>n</i> ]. Used by the factory, typically for diagnostic purposes.	Min/Max: 0 / 65535		
		31	<b>755 (8+) Testpoint Val 1</b>	Default: 0.000000	RO	Real
		33	<b>755 (8+) Testpoint Val 2</b> Testpoint Value 1, 2 Displays data selected by [Testpoint Sel <i>n</i> ].	Min/Max: -/+220000000.000000		

# Precharge *n* (Port 11) Parameters

Precharge *n* parameters apply only to PowerFlex 755 Common DC Input Frame 8 and larger drives.

File	Group	No.	Display Name Full Name Description	Values	Read-Write	Data Type																												
PRECHARGE N	Status	104	<b>755 (8+)</b> <b>P1 Board Status</b>		RO	32-bit Integer																												
		204	<b>755 (8+)</b> <b>P2 Board Status</b>																															
		304	<b>755 (8+)</b> <b>P3 Board Status</b>																															
		Precharge <i>n</i> Board Status																																
		Status bits for the precharge board.																																
		Options	ReadyToReset	Flash Update	Reserved	Reserved	Reserved	Reserved	Flash Failed	MCS AuxInput	MCS UVDlyOut	MCS SprgChgOt	MCS ShntRelOt	MCS ClsCIOut	Ext FaultRst	Ext Inhibit	Ext Opn/Cls	Fan Out	DoorLock Out	DoorLock In	BusNegFuselIn	BusPosFuselIn	Discnct Out	Discnct In	DC Bus OK	240V ACPresnt	Reserved	Alarm	Faulted	MCS Opening	Prechrg Done	MCS Closing	Ready	
		Default	0	0	0	0	0	0	0	0	0	0	0	0	0	0	0	0	0	0	0	0	0	0	0	0	0	0	0	0	0	0	0	
		Bit	31	30	29	28	27	26	25	24	23	22	21	20	19	18	17	16	15	14	13	12	11	10	9	8	7	6	5	4	3	2	1	0
					0 = False 1 = True																													
		Bit 0 "Ready" – CB controller is ready to begin the precharge sequence. Stop input is not active, 240V AC is present, molded case switch (MCS) auxiliary contact is open, disconnect is closed and there are no faults.																																
Bit 1 "MCS Closing" – The precharge sequence is in progress but is not complete.																																		
Bit 2 "Prechrg Done" – Precharge has been completed and the MCS is closed.																																		
Bit 3 "MCS Opening" – The MCS is in the process of opening.																																		
Bit 4 "Faulted" – A fault has occurred and is enumerated in the fault word.																																		
Bit 5 "Alarm" – An alarm has occurred and is enumerated in the alarm word.																																		
Bit 7 "240V ACPresnt" – 240V AC supply is present. Threshold is 85% or 204V AC.																																		
Bit 8 "DC Bus OK" – 0 = DC bus voltage out of tolerance. 1 = DC bus voltage is within tolerance.																																		
Bit 9 "Discnct In" – 0 = Auxiliary switch is off. 1 = Auxiliary switch is on.																																		
Bit 10 "Discnct Out" – 0 = Relay is off. 1 = Relay is on.																																		
Bit 11 "BusPosFuselIn" – 0 = Fuse is blown. 1 = Fuse is intact.																																		
Bit 12 "BusNegFuselIn" – 0 = Fuse is blown. 1 = Fuse is intact.																																		
Bit 13 "DoorLock In" – 0 = Door is open. 1 = Door is closed.																																		
Bit 14 "DoorLock Out" – 0 = Door solenoid relay is off. 1 = Door solenoid relay is on.																																		
Bit 15 "Fan Out" – 0 = Fan is on. 1 = Fan is off.																																		
Bit 16 "Ext Opn/Cls" – 0 = Inactive (tied to common or open). 1 = Active (24V DC applied).																																		
Bit 17 "Ext Inhibit" – 0 = Stopped (tied to common or open). 1 = Not Stopped (24V DC applied). Level sensitive. Ignored when fiber-optic communications is online.																																		
Bit 18 "Ext FaultRst" – 0 = Inactive (tied to common or open). 1 = Active (24V DC applied).																																		
Bit 19 "MCS ClsCIOut" – 0 = Relay is off. 1 = Relay is on.																																		
Bit 20 "MCSShntRelOt" – 0 = Relay is off. 1 = Relay is on.																																		
Bit 21 "MCSSprgChgOt" – 0 = Relay is off. 1 = Relay is on.																																		
Bit 22 "MCS UVDlyOut" – 0 = Relay is off. 1 = Relay is on.																																		
Bit 23 "MCS AuxInput" – 0 = MCS auxiliary contact is open. 1 = MCS auxiliary contact is closed.																																		
Bit 24 "Flash Failed" – An error occurred during the flash update process.																																		
Bit 30 "Flash Update" – The precharge controller is in flash update mode.																																		
Bit 31 "ReadyToReset" – The flash update process has ended and the precharge controller is waiting for a reset command.																																		



File	Group	No.	Display Name Full Name Description	Values	Read-Write	Data Type
PRECHARGE N	Metering	110	<b>P1 DC Bus Volts</b>	Units: V DC Default: 0.0 Min/Max: 0.0 / 1200.0	RO	Real
		210	<b>P2 DC Bus Volts</b>			
		310	<b>P3 DC Bus Volts</b> Precharge <i>n</i> DC Bus Voltage Indicates the DC voltage on the inverter capacitor bank. This voltage is measured at a point after the precharge resistors and contactor.			
		111	<b>P1 Main DC Volts</b>	Units: V DC Default: 0.0 Min/Max: 0.0 / 1200.0	RO	Real
		211	<b>P2 Main DC Volts</b>			
		311	<b>P3 Main DC Volts</b> Precharge <i>n</i> Main DC Voltage Indicates the input DC voltage to the drive. This voltage is measured at the input to the drive before the precharge resistors and contactor.			
		112	<b>P1 240VSpVVolts</b>	Units: V AC Default: 0.0 Min/Max: 0.0 / 500.0	RO	Real
		212	<b>P2 240VSpVVolts</b>			
		312	<b>P3 240VSpVVolts</b> Precharge <i>n</i> 240 V Supply Voltage Indicates the RMS output voltage of the 240V AC control transformer.			
		122	<b>P1 GateBoardTemp</b>	Units: DegC Default: 0.0 Min/Max: -/+200.0	RO	Real
		222	<b>P2 GateBoardTemp</b>			
		322	<b>P3 GateBoardTemp</b> Precharge <i>n</i> Gate Board Temperature Gate board temperature for precharge <i>n</i> .			

File	Group	No.	Display Name Full Name Description	Values	Read-Write	Data Type
PRECHARGE N	Predictive Main	137	<b>P1 PredMainReset</b>	Default: 0 = "Ready" Options: 0 = "Ready" 1 = "Cb Fan Life"	RW	Real
		237	<b>P2 PredMainReset</b>			
		337	<b>P3 PredMainReset</b> Precharge <i>n</i> Predictive Maintenance Reset Allows a reset of the elapsed run time to zero for the cabinet fan for precharge <i>n</i> . After the time has been reset, the value of this parameter returns to 0 "Ready."			
		138	<b>P1 CbFanElpsdLif</b>	Units: Hrs Default: 0.000 Min/Max: 0.000 / 2200000.000	RO	Real
		238	<b>P2 CbFanElpsdLif</b>			
		338	<b>P3 CbFanElpsdLif</b> Precharge <i>n</i> Cabinet Fan Elapsed Life The amount of time the cabinet fan for precharge <i>n</i> has been running. This value can be reset using [P <i>n</i> PredMainReset].			

File	Group	No.	Display Name Full Name Description	Values	Read-Write	Data Type
PRECHARGE N	Testpoints	140	755 (8+) P1 Testpt Sel 1	Default: 0 Min/Max: 0 / 65535	RW	32-bit Integer
		142	755 (8+) P1 Testpt Sel 2			
		240	755 (8+) P2 Testpt Sel 1			
		242	755 (8+) P2 Testpt Sel 2			
		340	755 (8+) P3 Testpt Sel 1			
		342	755 (8+) P3 Testpt Sel 2			
		Precharge <i>n</i> Testpoint Selection 1, 2 Selects a source for [P <i>n</i> Testpt Val <i>n</i> ]. Used by the factory, typically for diagnostic purposes.				
		141	755 (8+) P1 Testpt Val 1	Default: 0.000000 Min/Max: -/+220.000000	RO	Real
		143	755 (8+) P1 Testpt Val 2			
		241	755 (8+) P2 Testpt Val 1			
		243	755 (8+) P2 Testpt Val 2			
		341	755 (8+) P3 Testpt Val 1			
		343	755 (8+) P3 Testpt Val 2			
		Precharge <i>n</i> Testpoint Value 1, 2 Displays the data selected by or [P <i>n</i> Testpt Sel <i>n</i> ].				

**Notes:**

## Embedded Feature and Option Module Parameters

This chapter lists and describes the PowerFlex 750-Series drive embedded feature and option module parameters. The parameters can be programmed (viewed/edited) using a Human Interface Module (HIM). Refer to PowerFlex 20-HIM-A6 and 20-HIM-C6S HIM (Human Interface Module) User Manual, publication [20HIM-UM001](#), for information on using the HIM to view and edit parameters. As an alternative, programming can also be performed using DriveTools™ software and a personal computer.

Topic	Page
Embedded EtherNet/IP (Port 13) Parameters	240
Communication Configurations	246
Embedded DeviceLogix (Port 14) Parameters	249
11-Series I/O Module Parameters	252
22-Series I/O Module Parameters	262
Single Incremental Encoder Module Parameters	273
Dual Incremental Encoder Module Parameters	276
Universal Feedback Module Parameters	281
Safe Speed Monitor Module Parameters	299



## Embedded EtherNet/IP (Port 13) Parameters



For complete information on the Embedded EtherNet/IP feature, refer to the PowerFlex 755 Drive Embedded EtherNet/IP Adapter user manual, publication [750COM-UM001](#).

File	Group	No.	Display Name Full Name Description	Values	Read-Write	Data Type
Embedded EtherNet/IP		1 Thru 16	<b>755 DL From Net 01</b> <b>755 DL From Net 16</b>  Datalinks From Network 01...16 Sets the port number and parameter number to which the selected Datalink connects. Each selected port/parameter is written with data received from the network (outputs from the controller). <b>Parameters 1...14</b> can only link to floating point parameters. <b>Parameters 15 and 16</b> can only link to DINT parameters. If setting the value manually, the parameter value = (10000 x port number) + (destination parameter number). For example, to use P1 [DL From Net 01] to write to Parameter 1 of an optional encoder module plugged into drive Port 5. The value for P1 [DL From Net 01] must be 50001 [(10000 x 5) + 1].	Default: 0 Min/Max: 0 / 159999	RW	32-bit Integer
		17 Thru 32	<b>755 DL To Net 01</b> <b>755 DL To Net 16</b>  Datalinks To Network 01...16 Sets the port number and parameter number to which the selected Datalink connects. Each selected port/parameter is read and their values are transmitted over the network to the controller (inputs to the controller). <b>Parameters 17...30</b> can only link to floating point parameters. <b>Parameters 31 and 32</b> can only link to DINT parameters. If setting the value manually, the parameter value = (10000 x port number) + (origination parameter number). For example, to use P17 [DL To Net 01] to read Parameter 01 of an optional I/O module plugged into drive Port 4. The value for P17 [DL To Net 01] must be 40001 [(10000 x 4) + 1].	Default: 0 Min/Max: 0 / 159999	RW	32-bit Integer
		33	<b>755 Port Number</b> Port number Displays the drive port to which the embedded EtherNet/IP adapter is dedicated. This is always Port 13.	Default: 13 Value: 13 / 15	RO	32-bit Integer
		34	<b>755 DLs From Net Act</b> Datalinks From Network Actual Displays the number of actual controller-to- drive Datalinks that the drive is using based on the I/O connection opened by the controller.	Default: 0 Min/Max: 0 / 16	RO	32-bit Integer
		35	<b>755 DLs To Net Act</b> Datalinks To Network Actual Displays the number of actual drive-to- controller Datalinks that the controller is using based on the I/O connection opened by the controller.	Default: 0 Min/Max: 0 / 16	RO	32-bit Integer
		36	<b>755 BOOTP</b> Bootstrap Protocol Configures the adapter to use BOOTP so that you can set its IP address, subnet mask, and gateway address with a BOOTP server. When this parameter is disabled, you must use the adapter parameters to set these addressing functions. This parameter is only functional when the IP address switches are set to 001...254 or 888. Power cycle or reset is required for change to take affect.	Default: 1 = "Enabled" Options: 0 = "Disabled" 1 = "Enabled"	RW	32-bit Integer
		37	<b>755 Net Addr Src</b> Network Address Source Displays the source from which the adapter node address, subnet mask, and gateway are taken. This will be switches, Parameters 38...41 [IP Addr Cfg n], or BOOTP. It is determined by the settings of the octet switches on the adapter. See <a href="#">Establishing A Connection With EtherNet/IP on page 21</a> for details.	Default: 0 = "Switches" Options: 0 = "Switches" 1 = "Parameters" 2 = "BOOTP"	RO	32-bit Integer



File	Group	No.	Display Name Full Name Description	Values	Read-Write	Data Type
Embedded EtherNet/IP		38	<b>755 IP Addr Cfg 1</b>	Default: 0 Min/Max: 0 / 255	RW	32-bit Integer
		39	<b>755 IP Addr Cfg 2</b>			
		40	<b>755 IP Addr Cfg 3</b>			
		41	<b>755 IP Addr Cfg 4</b>			
			IP Address Configure 1...4 Sets the bytes in the IP address.  <div style="text-align: center;">                 255 . 255 . 255 . 255                                                       [IP Addr Cfg 1]                                                         [IP Addr Cfg 2]                                                         [IP Addr Cfg 3]                                                         Set with Octet Switch on Drive                  Main Control Board             </div> <p><b>Important:</b> To set the IP address using these parameters, P36 [BOOTP] must be set to "0" (Disabled) and switches set to a value other than 001...254 or 888. If the drive does not accept parameter settings, check the Octet switch on the drive main control board. Set to 999 and cycle power to the drive.</p>			
42	<b>755 Subnet Cfg 1</b>	Default: 0 Min/Max: 0 / 255	RW	32-bit Integer		
43	<b>755 Subnet Cfg 2</b>					
44	<b>755 Subnet Cfg 3</b>					
45	<b>755 Subnet Cfg 4</b>					
	Subnet Configure 1...4 Sets the bytes of the subnet mask.  <div style="text-align: center;">                 255 . 255 . 255 . 255                                                       [Subnet Cfg 1]                                                         [Subnet Cfg 2]                                                         [Subnet Cfg 3]                                                         [Subnet Cfg 4]             </div> <p><b>Important:</b> To set the subnet mask using these parameters, P36 [BOOTP] must be set to "0" (Disabled) and switches set to a value other than 001...254 or 888.</p>					
46	<b>755 Gateway Cfg 1</b>	Default: 0 Min/Max: 0 / 255	RW	32-bit Integer		
47	<b>755 Gateway Cfg 2</b>					
48	<b>755 Gateway Cfg 3</b>					
49	<b>755 Gateway Cfg 4</b>					
	Gateway Configure 1...4 Sets the bytes of the gateway address.  <div style="text-align: center;">                 255 . 255 . 255 . 255                                                       [Gateway Cfg 1]                                                         [Gateway Cfg 2]                                                         [Gateway Cfg 3]                                                         [Gateway Cfg 4]             </div> <p><b>Important:</b> To set the gateway address using these parameters, P36 [BOOTP] must be set to "0" (Disabled) and switches set to a value other than 001...254 or 888.</p>					
50	<b>755 Net Rate Cfg</b>	Default: 0 = "Autodetect" Options: 0 = "Autodetect" 1 = "10Mbps Full" 2 = "10Mbps Half" 3 = "100Mbps Full" 4 = "100Mbps Half"	RW	32-bit Integer		

File	Group	No.	Display Name Full Name Description	Values	Read-Write	Data Type																																																			
Embedded EtherNet/IP		51	<b>755 Net Rate Act</b> Network Rate Actual Displays the actual network data rate used by the adapter.	Default: 0 = "No Link" Options: 0 = "No Link" 1 = "10Mbps Full" 2 = "10Mbps Half" 3 = "100Mbps Full" 4 = "100Mbps Half" 5 = "Dup IP Addr"	RO	32-bit Integer																																																			
		52	<b>755 Web Enable</b> Web Enabled Enables/disables the adapter Web page features. For detailed information on the Web enable feature, refer to the PowerFlex 755 Drive Embedded EtherNet/IP Adapter User Manual, publication 750COM-UM001.	Default: 0 = "Disabled" Options: 0 = "Disabled" 1 = "Enabled"	RW	32-bit Integer																																																			
		53	<b>755 Web Features</b> Web Features Enables/disables the Web-configurable e-mail notification feature. For detailed information on the Web enable feature, refer to the PowerFlex 755 Drive Embedded EtherNet/IP Adapter User Manual, publication <a href="#">750COM-UM001</a> .  Options	<table border="1"> <tr> <td></td> <td>Reserved</td><td>Reserved</td><td>Reserved</td><td>Reserved</td><td>Reserved</td><td>Reserved</td><td>Reserved</td><td>Reserved</td><td>Reserved</td><td>Reserved</td><td>Reserved</td><td>Reserved</td><td>Reserved</td><td>Reserved</td><td>Reserved</td><td>Email Config</td> </tr> <tr> <td>Default</td> <td>0</td><td>0</td><td>0</td><td>0</td><td>0</td><td>0</td><td>0</td><td>0</td><td>0</td><td>0</td><td>0</td><td>0</td><td>0</td><td>0</td><td>0</td><td>1</td> </tr> <tr> <td>Bit</td> <td>15</td><td>14</td><td>13</td><td>12</td><td>11</td><td>10</td><td>9</td><td>8</td><td>7</td><td>6</td><td>5</td><td>4</td><td>3</td><td>2</td><td>1</td><td>0</td> </tr> </table> <p>0 = Disabled 1 = Enabled</p>		Reserved	Reserved	Reserved	Reserved	Reserved	Reserved	Reserved	Reserved	Reserved	Reserved	Reserved	Reserved	Reserved	Reserved	Reserved	Email Config	Default	0	0	0	0	0	0	0	0	0	0	0	0	0	0	0	1	Bit	15	14	13	12	11	10	9	8	7	6	5	4	3	2	1	0	RW	16-bit Integer
			Reserved	Reserved	Reserved	Reserved	Reserved	Reserved	Reserved	Reserved	Reserved	Reserved	Reserved	Reserved	Reserved	Reserved	Reserved	Email Config																																							
		Default	0	0	0	0	0	0	0	0	0	0	0	0	0	0	0	1																																							
Bit	15	14	13	12	11	10	9	8	7	6	5	4	3	2	1	0																																									
54	<b>755 Comm Flt Action</b> Communication Fault Action Sets the action that the adapter and drive will take if the adapter detects that I/O communications have been disrupted. This setting is effective only if I/O that controls the drive is transmitted through the adapter.	Default: 0 = "Fault" Options: 0 = "Fault" 1 = "Stop" 2 = "Zero Data" 3 = "Hold Last" 4 = "Send Flt Cfg"	RW	32-bit Integer																																																					
		 <b>ATTENTION:</b> Risk of injury or equipment damage exists. P54 [Comm Flt Action] lets you determine the action of the adapter and connected drive if I/O communications are disrupted. By default, this parameter faults the drive. You can set this parameter so that the drive continues to run. Precautions should be taken to ensure that the setting of this parameter does not create a risk of injury or equipment damage. When commissioning the drive, verify that your system responds correctly to various situations (for example, a disconnected cable).																																																							
55	<b>755 Idle Flt Action</b> Idle Fault Action Sets the action that the adapter and drive will take if the adapter detects that the controller is in program mode or faulted. This setting is effective only if I/O that controls the drive is transmitted through the adapter.	Default: 0 = "Fault" Options: 0 = "Fault" 1 = "Stop" 2 = "Zero Data" 3 = "Hold Last" 4 = "Send Flt Cfg"	RW	32-bit Integer																																																					
		 <b>ATTENTION:</b> Risk of injury or equipment damage exists. P55 [Idle Flt Action] lets you determine the action of the adapter and connected drive when the controller is idle. By default, this parameter faults the drive. You can set this parameter so that the drive continues to run. Precautions should be taken to ensure that the setting of this parameter does not create a risk of injury or equipment damage. When commissioning the drive, verify that your system responds correctly to various situations (for example, a controller in idle state).																																																							

File	Group	No.	Display Name Full Name Description	Values	Read-Write	Data Type	
Embedded EtherNet/IP		56	<b>755 Peer Flt Action</b> Peer Fault Action Sets the action that the adapter and drive will take if the adapter detects that Peer I/O communications have been disrupted. This setting is effective only if I/O is transmitted through the adapter. For detailed information on peer communications, refer to the PowerFlex 755 Drive Embedded EtherNet/IP Adapter User Manual, publication 750COM-UM001.	Default: 0 = "Fault" Options: 0 = "Fault" 1 = "Stop" 2 = "Zero Data" 3 = "Hold Last" 4 = "Send Flt Cfg"	RW	32-bit Integer	
		 <b>ATTENTION:</b> Risk of injury or equipment damage exists. P56 [Peer Flt Action] lets you determine the action of the adapter and connected drive if the adapter is unable to communicate with the designated peer. By default, this parameter faults the drive. You can set this parameter so that the drive continues to run. Precautions should be taken to ensure that the setting of this parameter does not create a risk of injury or equipment damage. When commissioning the drive, verify that your system responds correctly to various situations (for example, a disconnected cable).					
		57	<b>755 Msg Flt Action</b> Message Fault Action Sets the action that the adapter and drive will take if the adapter detects that explicit messaging, only when used for drive control via PCCC and the CIP Register Object, has been disrupted.	Default: 0 = "Fault" Options: 0 = "Fault" 1 = "Stop" 2 = "Zero Data" 3 = "Hold Last" 4 = "Send Flt Cfg"	RW	32-bit Integer	
 <b>ATTENTION:</b> Risk of injury or equipment damage exists. P57 [Msg Flt Action] lets you determine the action of the adapter and connected drive if explicit messaging for drive control is disrupted. By default, this parameter faults the drive. You can set this parameter so that the drive continues to run. Precautions should be taken to ensure that the setting of this parameter does not create a risk of injury or equipment damage. When commissioning the drive, verify that your system responds correctly to various situations (for example, a disconnected cable).							
		58	<b>755 Flt Cfg Logic</b> Fault Configure Logic Sets the Logic Command data that is sent to the drive if any of the following is true: <ul style="list-style-type: none"> <li>• P54 [Comm Flt Action] is set to 4 "Send Flt Cfg" and I/O communications are disrupted.</li> <li>• P55 [Idle Flt Action] is set to 4 "Send Flt Cfg" and the controller is idle.</li> <li>• P56 [Peer Flt Action] is set to 4 "Send Flt Cfg" and Peer I/O communications are disrupted.</li> <li>• P57 [Msg Flt Action] is set to 4 "Send Flt Cfg" and explicit messaging for drive control is disrupted.</li> </ul> The bit definitions in the Logic Command word for PowerFlex 750-Series drives are shown on <a href="#">page 247</a> .	Default: 0000 0000 0000 0000 0000 0000 0000 0000 Min/Max: 0000 0000 0000 0000 0000 0000 0000 0000 1111 1111 1111 1111 1111 1111 1111 1111	RW	32-bit Integer	
		59	<b>755 Flt Cfg Ref</b> Fault Configure Reference Sets the Reference data that is sent to the drive if any of the following is true: <ul style="list-style-type: none"> <li>• P54 [Comm Flt Action] is set to 4 "Send Flt Cfg" and I/O communications are disrupted.</li> <li>• P55 [Idle Flt Action] is set to 4 "Send Flt Cfg" and the controller is idle.</li> <li>• P56 [Peer Flt Action] is set to 4 "Send Flt Cfg" and Peer I/O communications are disrupted.</li> <li>• P57 [Msg Flt Action] is set to 4 "Send Flt Cfg" and explicit messaging for drive control is disrupted.</li> </ul>	Default: 0 Min/Max: -/+--220000000	RW	Real	

File	Group	No.	Display Name Full Name Description	Values	Read-Write	Data Type
Embedded EtherNet/IP		60 Thru 75	<p><b>755 Flt Cfg DL 01</b></p> <p><b>755 Flt Cfg DL 16</b></p> <p>Fault Configure DeviceLogix</p> <p>Sets the data that is sent to the Datalink in the drive if any of the following is true:</p> <ul style="list-style-type: none"> <li>• P54 [Comm Flt Action] is set to 4 "Send Flt Cfg" and I/O communications are disrupted.</li> <li>• P55 [Idle Flt Action] is set to 4 "Send Flt Cfg" and the controller is idle.</li> <li>• P56 [Peer Flt Action] is set to 4 "Send Flt Cfg" and Peer I/O communications are disrupted.</li> <li>• P57 [Msg Flt Action] is set to 4 "Send Flt Cfg" and explicit messaging for drive control is disrupted.</li> </ul>	Default: 0 Min/Max: 0 / 4294967295	RW	32-bit Integer
		76	<p><b>755 DLs Fr Peer Cfg</b></p> <p>Datalinks From Peer Configure</p> <p>Sets the number of network-to-drive Datalinks (parameters) that are used for peer I/O. The Datalinks being used are allocated from the end of the list. For example, if this parameter's value is set to 3, Datalinks 14... 16 are allocated for the three selected Datalinks. The Datalinks allocated for peer I/O cannot overlap with other assigned DL From Net 01... 16 parameters.</p> <p>For detailed information on peer communications, refer to the PowerFlex 755 Drive Embedded EtherNet/IP Adapter User Manual, publication 750COM-UM001.</p>	Default: 0 Min/Max: 0 / 16	RW	32-bit Integer
		77	<p><b>755 DLs Fr Peer Act</b></p> <p>Datalinks From Peer Action</p> <p>Displays the value of P76 [DLs Fr Peer Cfg] at the time the drive was reset. This is the number of actual peer-to-drive Datalinks that the drive is expecting.</p>	Default: 0 Min/Max: 0 / 16	RO	32-bit Integer
		78	<p><b>755 Logic Src Cfg</b></p> <p>Logic Source Configure</p> <p>Controls which of the peer-to-drive Datalinks contain the Logic Command for the drive. For detailed information on peer communications, refer to the PowerFlex 755 Drive Embedded EtherNet/IP Adapter User Manual, publication 750COM-UM001.</p>	Default: 0 Min/Max: 0 / 16	RW	32-bit Integer
		79	<p><b>755 Ref Src Cfg</b></p> <p>Reference Source Configure</p> <p>Controls which of the peer-to-drive Datalinks contain the Reference for the drive. For detailed information on peer communications, refer to the PowerFlex 755 Drive Embedded EtherNet/IP Adapter User Manual, publication 750COM-UM001.</p>	Default: 0 Min/Max: 0 / 16	RW	32-bit Integer
		80	<p><b>755 Fr Peer Timeout</b></p> <p>From Peer Timeout</p> <p>Sets the timeout for a Peer I/O connection. If the time is reached without the adapter receiving (consuming) a message, the adapter will respond with the action specified in P56 [Peer Flt Action].</p> <p>In an adapter receiving (consuming) Peer I/O, the value of this parameter must be greater than the product of the value of P89 [To Peer Period] in the adapter transmitting (producing) Peer I/O multiplied by the value of P90 [To Peer Skip] in the adapter transmitting (producing) Peer I/O.</p> <p>For detailed information on peer communications, refer to the PowerFlex 755 Drive Embedded EtherNet/IP Adapter User Manual, publication 750COM-UM001.</p>	Units: Secs Default: 10.00 Min/Max: 0.00 / 200.00	RW	Real

File	Group	No.	Display Name Full Name Description	Values	Read-Write	Data Type
Embedded EtherNet/IP		81	<b>755 Fr Peer Addr 1</b>	Default: 0 Min/Max: 0 / 255	RW	32-bit Integer
		82	<b>755 Fr Peer Addr 2</b>			
		83	<b>755 Fr Peer Addr 3</b>			
		84	<b>755 Fr Peer Addr 4</b>			
			From Peer Address 1 . . . 4 Sets the bytes in the IP address that specifies the device from which the adapter receives (consumes) Peer I/O data.  <div style="text-align: center;"> </div> <p><b>Important:</b> The Peer Inp Addr must be on the same subnet as the embedded EtherNet/IP adapter. Changes to these parameters are ignored when P85 [Fr Peer Enable] is "1" (On). For detailed information on peer communications, refer to the PowerFlex 755 Drive Embedded EtherNet/IP Adapter User Manual, publication 750COM-UM001.</p>			
		85	<b>755 Fr Peer Enable</b> From Peer Enable Controls whether Peer I/O input is operating. A value of 0 "Off" turns off Peer I/O input. A value of 1 "Cmd/Ref" overrides the settings in Parameters P76 [DLs Fr Peer Cfg], P78 [Logic Src Cfg], and P79 [Ref Src Cfg] and automatically uses peer Datalink 01 as the drive's present Logic Command and peer Datalink 02 as the drive's Reference. A value of 2 "Custom" enables peer I/O input using the Datalink count and settings provided by the user. For detailed information on peer communications, refer to the PowerFlex 755 Drive Embedded EtherNet/IP Adapter User Manual, publication 750COM-UM001.	Default: 0 = "Off" Options: 0 = "Off" 1 = "Cmd/Ref" 2 = "Custom"	RW	32-bit Integer
86	<b>755 Fr Peer Status</b> From Peer Status Displays the status of the consumed Peer I/O input connection. For detailed information on peer communications, refer to the PowerFlex 755 Drive Embedded EtherNet/IP Adapter User Manual, publication 750COM-UM001.	Default: 0 = "Off" Options: 0 = "Off" 1 = "Waiting" 2 = "Running" 3 = "Faulted"	RO	32-bit Integer		
87	<b>755 DLs To Peer Cfg</b> Datalinks To Peer Configure Sets the number of drive-to-network Datalinks (parameters) that are used for Peer I/O. The Datalinks being used are allocated from the end of the list. For example, if this parameter's value is set to 3, Datalinks 14 . . . 16 are allocated for the three selected Datalinks. The Datalinks allocated for this cannot overlap with other assigned DL To Net 01 . . . 16 parameters. For detailed information on peer communications, refer to the PowerFlex 755 Drive Embedded EtherNet/IP Adapter User Manual, publication 750COM-UM001.	Default: 0 Min/Max: 0 / 16	RW	32-bit Integer		
88	<b>755 DLs To Peer Act</b> Datalinks To Peer Action Displays the value of P87 [DLs To Peer Cfg] at the time the drive was reset. This is the number of actual drive-to-peer Datalinks that the drive is expecting.	Default: 0 Min/Max: 0 / 16	RO	32-bit Integer		

File	Group	No.	Display Name Full Name Description	Values		Read-Write	Data Type
Embedded EtherNet/IP		89	<b>755 To Peer Period</b> To Peer Period Sets the minimum time that an adapter will wait when transmitting data to a peer. <b>Important:</b> Changes to this parameter are ignored when P91 [To Peer Enable] is 0 "Off."	Units: Default: Min/Max:	Secs 10.00 0.01 / 10.00	RW	Real
		90	<b>755 To Peer Skip</b> To Peer Skip Sets the maximum time that an adapter will wait when transmitting data to a peer. The value of P89 [To Peer Period] is multiplied by the value of this parameter to set the time. <b>Important:</b> Changes to this parameter are ignored when P91 [To Peer Enable] is 0 "Off."	Default: Min/Max:	1 1 / 16	RW	32-bit Integer
		91	<b>755 To Peer Enable</b> To Peer Enable Controls whether Peer I/O output is operating. A value of 0 "Off" turns off Peer I/O output. A value of 1 "Cmd/Ref" overrides the settings in Parameters P31 [DL To Net 15], P32 [DL To Net 16], P76 [DLs Fr Peer Cfg], and P77 [DLs Fr Peer Act], and automatically sends the drive's present Logic Command (as Datalink 01) and Reference (as Datalink 02). A value of 2 "Custom" enables Peer I/O output using the Datalink count and settings provided by the user.	Default: Options:	0 = "Off" 0 = "Off" 1 = "Cmd/Ref" 2 = "Custom"	RW	32-bit Integer

## Communication Configurations

### 20-COMM-\* Network Adapter Compatibility

Some 20-COMM adapters can be used with PowerFlex 750-Series drives. See "20-COMM Carrier" in the Installation Instructions, publication 750-IN001, for more information.

---

**IMPORTANT** When a 20-COMM Carrier (20-750-20COMM) is used to install a 20-COMM adapter on a 750-Series drive, the upper word (Bits 16...31) of the Logic Command Word and Logic Status Word are not accessible. The upper word is only used and accessible on 750-Series communication modules (20-750-\*) and the embedded EtherNet/IP on PowerFlex 755 drives.

---

### Typical Programmable Controller Configurations

---

**IMPORTANT** If block transfers are programmed to continuously write information to the drive, care must be taken to properly format the block transfer. If attribute 10 is selected for the block transfer, values will be written only to RAM and will not be saved by the drive. This is the preferred attribute for continuous transfers. If attribute 9 is selected, each program scan will complete a write to the drives non-volatile memory (EEPROM). Since the EEPROM has a fixed number of allowed writes, continuous block transfers will quickly damage the EEPROM. Do Not assign attribute 9 to continuous block transfers. Refer to the individual communications adapter User Manual for additional details.

---

## Logic Command/Status Words

Table 4 - Logic Command Word

Logic Bits																	Command	Description														
3	3	2	2	2	2	2	2	2	2	2	1	1	1	1	1	1			1	1	9	8	7	6	5	4	3	2	1	0		
																													X	Normal Stop	0 = Not Normal Stop 1 = Normal Stop	
																													X	Start <sup>(1)</sup>	0 = Not Start 1 = Start	
																													X	Jog 1 <sup>(2)</sup>	0 = Not Jog 1 (Par. 556) 1 = Jog 1	
																													X	Clear Fault <sup>(3)</sup>	0 = Not Clear Fault 1 = Clear Fault	
																								X	X					Unipolar Direction	00 = No Command 01 = Forward Command 10 = Reverse Command 11 = Hold Direction Control	
																													X	Manual	0 = Not Manual 1 = Manual	
																													X	Reserved		
																													X	X	Accel Time	00 = No Command 01 = Use Accel Time 1 (Par. 535) 10 = Use Accel Time 2 (Par. 536) 11 = Use Present Time
																													X	X	Decel Time	00 = No Command 01 = Use Decel Time 1 (Par. 537) 10 = Use Decel Time 2 (Par. 538) 11 = Use Present Time
																													X	Ref Select 1	000 = No Command	
																													X	Ref Select 2	001 = Ref A Select (Par. 545) 010 = Ref B Select (Par. 550)	
																													X	Ref Select 3	011 = Preset 3 (Par. 573) 100 = Preset 4 (Par. 574) 101 = Preset 5 (Par. 575) 110 = Preset 6 (Par. 576) 111 = Preset 7 (Par. 577)	
																													X	Emrg OvrRide	0 = (Not set or clear) Emergency Override 1 = Set Emergency Override	
																													X	Coast Stop	0 = Not Coast to Stop 1 = Coast to Stop	
																													X	Current Limit Stop	0 = Not Current Limit Stop 1 = Current Limit Stop	
																													X	Run <sup>(4)</sup>	0 = Not Run 1 = Run	
																													X	Jog 2 <sup>(2)</sup>	0 = Not Jog 2 (Par. 557) 1 = Jog 2	
																													X	Reserved		
																													X	Reserved		
																													X	Reserved		
																													X	Reserved		
																													X	Reserved		
																													X	Reserved		
																													X	Reserved		
																													X	Reserved		
																													X	Reserved		
																													X	Reserved		
																													X	Reserved		
																													X	Reserved		

(1) A Not Stop condition (logic bit 0 = 0) must first be present before a 1 = Start condition will start the drive.  
 (2) A Not Stop condition (logic bit 0 = 0) must first be present before a 1 = Jog 1/Jog 2 condition will jog the drive. A transition to a "0" will stop the drive.  
 (3) To perform this command, the value must switch from "0" to "1."  
 (4) A Not Stop condition (logic bit 0 = 0) must first be present before a 1 = Run condition will run the drive. A transition to a "0" will stop the drive.

Table 5 - Logic Status Word

Logic Bits																																Command	Description		
31	30	29	28	27	26	25	24	23	22	21	20	19	18	17	16	15	14	13	12	11	10	9	8	7	6	5	4	3	2	1	0				
																																x	Run Ready	0 = Not Ready to Run 1 = Ready to Run	
																																x	Active	0 = Not Active 1 = Active	
																																x	Command Direction	0 = Reverse 1 = Forward	
																																x	Actual Direction	0 = Reverse 1 = Forward	
																																x	Accelerating	0 = Not Accelerating 1 = Accelerating	
																																x	Decelerating	0 = Not Decelerating 1 = Decelerating	
																																x	Alarm	0 = No Alarm (Par. 959 & 960) 1 = Alarm	
																																x	Fault	0 = No Fault (Par. 952 & 953) 1 = Fault	
																																x	At Setpt Spd	0 = Not at Setpoint Speed 1 = At Setpoint Speed	
																																x	Manual	0 = Manual Mode Not Active 1 = Manual Mode Active	
																																		Spd Ref ID 0	00000 = Reserved
																																		Spd Ref ID 1	00001 = Auto Ref A (par. 545)
																																		Spd Ref ID 2	00010 = Auto Ref B (Par. 550)
																																		Spd Ref ID 3	00011 = Auto Preset Speed 3 (Par. 573)
																																		Spd Ref ID 4	00100 = Auto Preset Speed 4 (Par. 574) 00101 = Auto Preset Speed 5 (Par. 575) 00110 = Auto Preset Speed 6 (Par. 576) 00111 = Auto Preset Speed 7 (Par. 577) 01000 = Reserved 01001 = Reserved 01010 = Reserved 01011 = Reserved 01100 = Reserved 01101 = Reserved 01110 = Reserved 01111 = Reserved 10000 = Man Port 0 10001 = Man Port 1 10010 = Man Port 2 10011 = Man Port 3 10100 = Man Port 4 10101 = Man Port 5 10110 = Man Port 6 10111 = Reserved 11000 = Reserved 11001 = Reserved 11010 = Reserved 11011 = Reserved 11100 = Reserved 11101 = Man Port 13 (Emb. ENET) 11110 = Man Port 14 (Drive Logix) 11111 = Alternate Man Ref Sel
																																		Emrg OvrRide	0 = (Not set or clear) Emergency Override 1 = Set Emergency Override
																																		Running	0 = Not Running 1 = Running
																																		Jogging	0 = Not Jogging (Par. 556 & 557) 1 = Jogging
																																		Stopping	0 = Not Stopping 1 = Stopping
																																		DC Brake	0 = Not DC Brake 1 = DC Brake
																																		DB Active	0 = Not Dynamic Brake Active 1 = Dynamic Brake Active
																																		Speed Mode	0 = Not Speed Mode (Par. 309) 1 = Speed Mode
																																		Position Mode	0 = Not Position Mode (Par. 309) 1 = Position Mode
																																		Torque Mode	0 = Not Torque Mode (Par. 309) 1 = Torque Mode
																																		At Zero Speed	0 = Not at Zero Speed 1 = At Zero Speed
																																		At Home	0 = Not at Home 1 = At Home
																																		At Limit	0 = Not at Limit 1 = At Limit
																																		Current Limit	0 = Not at Current Limit 1 = At Current Limit
																																		Bus Freq Reg	0 = Not Bus Freq Reg 1 = Bus Freq Reg
																																		Enable On	0 = Not Enable On 1 = Enable On
																																		Motor Overload	0 = Not Motor Overload 1 = Motor Overload
																																		Regen	0 = Not Regen 1 = Regen





## Embedded DeviceLogix (Port 14) Parameters

File	Group	No.	Display Name Full Name Description	Values	Read-Write	Data Type																																																																																																	
Embedded DeviceLogix	Analog Outputs	1 Thru 14	<b>DLX Out 01</b>  <b>DLX Out 14</b> Fourteen floating point outputs that can be controlled by the DeviceLogix program. These are typically mapped to a parameter to write its value. It can also be mapped to the Reference Command.	Default: 0 Min/Max: 0 / 159999	RW	32-bit Real																																																																																																	
		15 16	<b>DLX Out 15</b> <b>DLX Out 16</b> Two unsigned 32-bit integer outputs that can be controlled by the DeviceLogix program. These are typically mapped to a parameter to write its value.	Default: 0 Min/Max: 0 / 159999	RW	32-bit Integer																																																																																																	
	Analog Inputs	17 Thru 30	<b>DLX In 01</b>  <b>DLX In 14</b> Fourteen floating point inputs that can be read by the DeviceLogix program. These are typically mapped to a parameter to read its value. It can also be mapped to Common Feedback.	Default: 0 Min/Max: 0 / 159999	RW	32-bit Real																																																																																																	
		31 32	<b>DLX In 15</b> <b>DLX In 16</b> Two unsigned 32-bit integer inputs that can be read by the DeviceLogix program. These are typically mapped to a parameter to read its value. It can also be mapped to Real Time Clock values.	Default: 0 Min/Max: 0 / 159999.15	RW	32-bit Integer																																																																																																	
	Digital Inputs	33 Thru 48	<b>DLX DIP 01</b>  <b>DLX DIP 16</b> Sixteen digital inputs that can be read by the DeviceLogix program. These are typically mapped to an input point in an I/O option module or to Logic Status bits.	Default: 0.00 Min/Max: 0 / 159999.15	RW	32-bit Integer																																																																																																	
		49	<b>DLX DigIn Sts</b> Provides the individual on/off status of the 16 DLX DIP's.  Options <table border="1" style="width: 100%; border-collapse: collapse;"> <tr> <td></td> <td>DLX DIPVal16</td><td>DLX DIPVal15</td><td>DLX DIPVal14</td><td>DLX DIPVal13</td><td>DLX DIPVal12</td><td>DLX DIPVal11</td><td>DLX DIPVal10</td><td>DLX DIPVal9</td><td>DLX DIPVal8</td><td>DLX DIPVal7</td><td>DLX DIPVal6</td><td>DLX DIPVal5</td><td>DLX DIPVal4</td><td>DLX DIPVal3</td><td>DLX DIPVal2</td><td>DLX DIPVal1</td> </tr> <tr> <td>Default</td> <td>0</td><td>0</td><td>0</td><td>0</td><td>0</td><td>0</td><td>0</td><td>0</td><td>0</td><td>0</td><td>0</td><td>0</td><td>0</td><td>0</td><td>0</td><td>0</td> </tr> <tr> <td>Bit</td> <td>15</td><td>14</td><td>13</td><td>12</td><td>11</td><td>10</td><td>9</td><td>8</td><td>7</td><td>6</td><td>5</td><td>4</td><td>3</td><td>2</td><td>1</td><td>0</td> </tr> </table> 0 = Condition Off 1 = Condition On		DLX DIPVal16	DLX DIPVal15	DLX DIPVal14	DLX DIPVal13	DLX DIPVal12	DLX DIPVal11	DLX DIPVal10	DLX DIPVal9	DLX DIPVal8	DLX DIPVal7	DLX DIPVal6	DLX DIPVal5	DLX DIPVal4	DLX DIPVal3	DLX DIPVal2	DLX DIPVal1	Default	0	0	0	0	0	0	0	0	0	0	0	0	0	0	0	0	Bit	15	14	13	12	11	10	9	8	7	6	5	4	3	2	1	0	RO	16-bit Integer																																															
		DLX DIPVal16	DLX DIPVal15	DLX DIPVal14	DLX DIPVal13	DLX DIPVal12	DLX DIPVal11	DLX DIPVal10	DLX DIPVal9	DLX DIPVal8	DLX DIPVal7	DLX DIPVal6	DLX DIPVal5	DLX DIPVal4	DLX DIPVal3	DLX DIPVal2	DLX DIPVal1																																																																																						
	Default	0	0	0	0	0	0	0	0	0	0	0	0	0	0	0	0																																																																																						
	Bit	15	14	13	12	11	10	9	8	7	6	5	4	3	2	1	0																																																																																						
	Status & Cntl	50	<b>DLX DigOut Sts</b> Provides the individual on/off status of the DLX Logic Command word bits.  Options <table border="1" style="width: 100%; border-collapse: collapse;"> <tr> <td></td> <td>Reserved</td><td>Reserved</td><td>Reserved</td><td>Reserved</td><td>Reserved</td><td>Reserved</td><td>Reserved</td><td>Reserved</td><td>Reserved</td><td>Reserved</td><td>Reserved</td><td>Reserved</td><td>Reserved</td><td>Reserved</td><td>Reserved</td><td>Reserved</td><td>DLX CmdSts16</td><td>DLX CmdSts15</td><td>DLX CmdSts14</td><td>DLX CmdSts13</td><td>DLX CmdSts12</td><td>DLX CmdSts11</td><td>DLX CmdSts10</td><td>DLX CmdSts9</td><td>DLX CmdSts8</td><td>DLX CmdSts7</td><td>DLX CmdSts6</td><td>DLX CmdSts5</td><td>DLX CmdSts4</td><td>DLX CmdSts3</td><td>DLX CmdSts2</td><td>DLX CmdSts1</td> </tr> <tr> <td>Default</td> <td>0</td><td>0</td><td>0</td><td>0</td><td>0</td><td>0</td><td>0</td><td>0</td><td>0</td><td>0</td><td>0</td><td>0</td><td>0</td><td>0</td><td>0</td><td>0</td><td>0</td><td>0</td><td>0</td><td>0</td><td>0</td><td>0</td><td>0</td><td>0</td><td>0</td><td>0</td><td>0</td><td>0</td><td>0</td><td>0</td><td>0</td><td>0</td> </tr> <tr> <td>Bit</td> <td>31</td><td>30</td><td>29</td><td>28</td><td>27</td><td>26</td><td>25</td><td>24</td><td>23</td><td>22</td><td>21</td><td>20</td><td>19</td><td>18</td><td>17</td><td>16</td><td>15</td><td>14</td><td>13</td><td>12</td><td>11</td><td>10</td><td>9</td><td>8</td><td>7</td><td>6</td><td>5</td><td>4</td><td>3</td><td>2</td><td>1</td><td>0</td> </tr> </table> 0 = Condition Off 1 = Condition On		Reserved	Reserved	Reserved	Reserved	Reserved	Reserved	Reserved	Reserved	Reserved	Reserved	Reserved	Reserved	Reserved	Reserved	Reserved	Reserved	DLX CmdSts16	DLX CmdSts15	DLX CmdSts14	DLX CmdSts13	DLX CmdSts12	DLX CmdSts11	DLX CmdSts10	DLX CmdSts9	DLX CmdSts8	DLX CmdSts7	DLX CmdSts6	DLX CmdSts5	DLX CmdSts4	DLX CmdSts3	DLX CmdSts2	DLX CmdSts1	Default	0	0	0	0	0	0	0	0	0	0	0	0	0	0	0	0	0	0	0	0	0	0	0	0	0	0	0	0	0	0	0	0	Bit	31	30	29	28	27	26	25	24	23	22	21	20	19	18	17	16	15	14	13	12	11	10	9	8	7	6	5	4	3	2	1	0	RO
		Reserved	Reserved	Reserved	Reserved	Reserved	Reserved	Reserved	Reserved	Reserved	Reserved	Reserved	Reserved	Reserved	Reserved	Reserved	Reserved	DLX CmdSts16	DLX CmdSts15	DLX CmdSts14	DLX CmdSts13	DLX CmdSts12	DLX CmdSts11	DLX CmdSts10	DLX CmdSts9	DLX CmdSts8	DLX CmdSts7	DLX CmdSts6	DLX CmdSts5	DLX CmdSts4	DLX CmdSts3	DLX CmdSts2	DLX CmdSts1																																																																						
Default	0	0	0	0	0	0	0	0	0	0	0	0	0	0	0	0	0	0	0	0	0	0	0	0	0	0	0	0	0	0	0	0																																																																							
Bit	31	30	29	28	27	26	25	24	23	22	21	20	19	18	17	16	15	14	13	12	11	10	9	8	7	6	5	4	3	2	1	0																																																																							

File	Group	No.	Display Name Full Name Description	Values	Read-Write	Data Type																																																																																																			
Embedded Device Logic	Status & Cntrl	51	<b>DLX DigOut Sts2</b> Provides the individual on/off status of the 16 DLX DOPs.	<table border="1"> <thead> <tr> <th>Options</th> <th>Reserved</th><th>Reserved</th><th>Reserved</th><th>Reserved</th><th>Reserved</th><th>Reserved</th><th>Reserved</th><th>Reserved</th><th>Reserved</th><th>Reserved</th><th>Reserved</th><th>Reserved</th><th>Reserved</th><th>Reserved</th><th>Reserved</th><th>Reserved</th><th>DLX DOPSts16</th><th>DLX DOPSts15</th><th>DLX DOPSts14</th><th>DLX DOPSts13</th><th>DLX DOPSts12</th><th>DLX DOPSts11</th><th>DLX DOPSts10</th><th>DLX DOPSts9</th><th>DLX DOPSts8</th><th>DLX DOPSts7</th><th>DLX DOPSts6</th><th>DLX DOPSts5</th><th>DLX DOPSts4</th><th>DLX DOPSts3</th><th>DLX DOPSts2</th><th>DLX DOPSts1</th> </tr> </thead> <tbody> <tr> <td>Default</td> <td>0</td><td>0</td><td>0</td><td>0</td><td>0</td><td>0</td><td>0</td><td>0</td><td>0</td><td>0</td><td>0</td><td>0</td><td>0</td><td>0</td><td>0</td><td>0</td><td>0</td><td>0</td><td>0</td><td>0</td><td>0</td><td>0</td><td>0</td><td>0</td><td>0</td><td>0</td><td>0</td><td>0</td><td>0</td><td>0</td><td>0</td><td>0</td> </tr> <tr> <td>Bit</td> <td>31</td><td>30</td><td>29</td><td>28</td><td>27</td><td>26</td><td>25</td><td>24</td><td>23</td><td>22</td><td>21</td><td>20</td><td>19</td><td>18</td><td>17</td><td>16</td><td>15</td><td>14</td><td>13</td><td>12</td><td>11</td><td>10</td><td>9</td><td>8</td><td>7</td><td>6</td><td>5</td><td>4</td><td>3</td><td>2</td><td>1</td><td>0</td> </tr> </tbody> </table> <p style="text-align: right;">0 = Condition Off 1 = Condition On</p>	Options	Reserved	Reserved	Reserved	Reserved	Reserved	Reserved	Reserved	Reserved	Reserved	Reserved	Reserved	Reserved	Reserved	Reserved	Reserved	Reserved	DLX DOPSts16	DLX DOPSts15	DLX DOPSts14	DLX DOPSts13	DLX DOPSts12	DLX DOPSts11	DLX DOPSts10	DLX DOPSts9	DLX DOPSts8	DLX DOPSts7	DLX DOPSts6	DLX DOPSts5	DLX DOPSts4	DLX DOPSts3	DLX DOPSts2	DLX DOPSts1	Default	0	0	0	0	0	0	0	0	0	0	0	0	0	0	0	0	0	0	0	0	0	0	0	0	0	0	0	0	0	0	0	0	Bit	31	30	29	28	27	26	25	24	23	22	21	20	19	18	17	16	15	14	13	12	11	10	9	8	7	6	5	4	3	2	1	0	RO	32-bit Integer
		Options	Reserved	Reserved	Reserved	Reserved	Reserved	Reserved	Reserved	Reserved	Reserved	Reserved	Reserved	Reserved	Reserved	Reserved	Reserved	Reserved	DLX DOPSts16	DLX DOPSts15	DLX DOPSts14	DLX DOPSts13	DLX DOPSts12	DLX DOPSts11	DLX DOPSts10	DLX DOPSts9	DLX DOPSts8	DLX DOPSts7	DLX DOPSts6	DLX DOPSts5	DLX DOPSts4	DLX DOPSts3	DLX DOPSts2	DLX DOPSts1																																																																							
		Default	0	0	0	0	0	0	0	0	0	0	0	0	0	0	0	0	0	0	0	0	0	0	0	0	0	0	0	0	0	0	0	0																																																																							
Bit	31	30	29	28	27	26	25	24	23	22	21	20	19	18	17	16	15	14	13	12	11	10	9	8	7	6	5	4	3	2	1	0																																																																									
52	<b>DLX Prog Cond</b> Defines the action that will be taken when the DLX logic is disabled. "Fault" (0) – Drive is faulted and stopped. "Stop" (1) – Drive is stopped, but not faulted. "Zero Data" (2) – Output data sent to the drive from DLX is zeroed (does not command a stop). "Hold Last" (3) – Drive continues in its present state.	Default: 0 = "Fault" Options: 0 = "Fault" 1 = "Stop" 2 = "Zero Data" 3 = "Hold Last"	RW	32-bit Integer																																																																																																					
53	<b>DLX Operation</b> Contains both operation commands as well as status information.	Default: 5 = "Logic Disabled" Options: 0 = "Enable Logic" 1 = "Disable Logic" 2 = "Reset Program" 3 = "Save Program" 4 = "Load Program" 5 = "Logic Disabled" 6 = "Logic Enabled"	RW	32-bit Integer																																																																																																					

File	Group	No.	Display Name Full Name Description	Values	Read-Write	Data Type																																																																																																				
Embedded DeviceLogix	Internal Regs	54 Thru 69	<b>DLX Real SP1</b>  <b>DLX Real SP16</b> Sixteen 32-bit Real scratchpad registers for DLX program use.	Default: 0 Min/Max: -/+220000000	RW	Real																																																																																																				
		70 Thru 77	<b>DLX DINT SP1</b>  <b>DLX DINT SP8</b> Eight 32-bit Integer scratchpad registers for DLX program use.	Default: 0 Min/Max: -2147483648 / 2147483647	RW	32-bit Integer																																																																																																				
		78 Thru 81	<b>DLX Bool SP1</b>  <b>DLX Bool SP4</b> Four 32-bit Boolean scratchpad registers (128 bits total) for DLX program use.		RW	32-bit Integer																																																																																																				
		<table border="1"> <thead> <tr> <th>Options</th> <th>Bit 31</th><th>Bit 30</th><th>Bit 29</th><th>Bit 28</th><th>Bit 27</th><th>Bit 26</th><th>Bit 25</th><th>Bit 24</th><th>Bit 23</th><th>Bit 22</th><th>Bit 21</th><th>Bit 20</th><th>Bit 19</th><th>Bit 18</th><th>Bit 17</th><th>Bit 16</th><th>Bit 15</th><th>Bit 14</th><th>Bit 13</th><th>Bit 12</th><th>Bit 11</th><th>Bit 10</th><th>Bit 9</th><th>Bit 8</th><th>Bit 7</th><th>Bit 6</th><th>Bit 5</th><th>Bit 4</th><th>Bit 3</th><th>Bit 2</th><th>Bit 1</th><th>Bit 0</th> </tr> </thead> <tbody> <tr> <td>Default</td> <td>0</td><td>0</td><td>0</td><td>0</td><td>0</td><td>0</td><td>0</td><td>0</td><td>0</td><td>0</td><td>0</td><td>0</td><td>0</td><td>0</td><td>0</td><td>0</td><td>0</td><td>0</td><td>0</td><td>0</td><td>0</td><td>0</td><td>0</td><td>0</td><td>0</td><td>0</td><td>0</td><td>0</td><td>0</td><td>0</td><td>0</td><td>0</td> </tr> <tr> <td>Bit</td> <td>31</td><td>30</td><td>29</td><td>28</td><td>27</td><td>26</td><td>25</td><td>24</td><td>23</td><td>22</td><td>21</td><td>20</td><td>19</td><td>18</td><td>17</td><td>16</td><td>15</td><td>14</td><td>13</td><td>12</td><td>11</td><td>10</td><td>9</td><td>8</td><td>7</td><td>6</td><td>5</td><td>4</td><td>3</td><td>2</td><td>1</td><td>0</td> </tr> </tbody> </table> <p style="text-align: right;">0 = Condition Off 1 = Condition On</p>						Options	Bit 31	Bit 30	Bit 29	Bit 28	Bit 27	Bit 26	Bit 25	Bit 24	Bit 23	Bit 22	Bit 21	Bit 20	Bit 19	Bit 18	Bit 17	Bit 16	Bit 15	Bit 14	Bit 13	Bit 12	Bit 11	Bit 10	Bit 9	Bit 8	Bit 7	Bit 6	Bit 5	Bit 4	Bit 3	Bit 2	Bit 1	Bit 0	Default	0	0	0	0	0	0	0	0	0	0	0	0	0	0	0	0	0	0	0	0	0	0	0	0	0	0	0	0	0	0	0	0	Bit	31	30	29	28	27	26	25	24	23	22	21	20	19	18	17	16	15	14	13	12	11	10	9	8	7	6	5	4	3	2	1	0
		Options	Bit 31	Bit 30	Bit 29	Bit 28	Bit 27	Bit 26	Bit 25	Bit 24	Bit 23	Bit 22	Bit 21	Bit 20	Bit 19	Bit 18	Bit 17	Bit 16	Bit 15	Bit 14	Bit 13	Bit 12	Bit 11	Bit 10	Bit 9	Bit 8	Bit 7	Bit 6	Bit 5	Bit 4	Bit 3	Bit 2	Bit 1	Bit 0																																																																								
		Default	0	0	0	0	0	0	0	0	0	0	0	0	0	0	0	0	0	0	0	0	0	0	0	0	0	0	0	0	0	0	0	0																																																																								
		Bit	31	30	29	28	27	26	25	24	23	22	21	20	19	18	17	16	15	14	13	12	11	10	9	8	7	6	5	4	3	2	1	0																																																																								
		82 Thru 89	<b>DLX Real In SP1</b>  <b>DLX Real In SP8</b> Eight 32-bit Real scratchpad registers for DLX program input use.	Default: 0 Min/Max: -/+220000000	RW	Real																																																																																																				
		90 Thru 97	<b>DLX Real OutSP1</b>  <b>DLX Real OutSP8</b> Eight 32-bit Real scratchpad registers for DLX program output use.	Default: 0 Min/Max: -/+220000000	RW	Real																																																																																																				
		98 Thru 101	<b>DLX DINT InSP1</b>  <b>DLX DINT InSP4</b> Four 32-bit Integer scratchpad registers for DLX program input use.	Default: 0 Min/Max: -2147483648 / 2147483647	RW	32-bit Integer																																																																																																				
102 Thru 105	<b>DLX DINT OutSP1</b>  <b>DLX DINT OutSP4</b> Four 32-bit Integer scratchpad registers for DLX program output use.	Default: 0 Min/Max: -2147483648 / 2147483647	RW	32-bit Integer																																																																																																						

# 11-Series I/O Module Parameters

File	Group	No.	Display Name Full Name Description	Values	Read-Write	Data Type																																																						
11-Series I/O	Digital Inputs	1	<b>Dig In Sts</b> Digital Input Status Status of the digital inputs.  Options <table border="1"> <tr> <td>Reserved</td><td>Reserved</td><td>Reserved</td><td>Reserved</td><td>Reserved</td><td>Reserved</td><td>Reserved</td><td>Reserved</td><td>Reserved</td><td>Reserved</td><td>Reserved</td><td>Reserved</td><td>Reserved</td><td>Reserved</td><td>Reserved</td><td>Input 2</td><td>Input 1</td><td>Input 0</td> </tr> <tr> <td>0</td><td>0</td><td>0</td><td>0</td><td>0</td><td>0</td><td>0</td><td>0</td><td>0</td><td>0</td><td>0</td><td>0</td><td>0</td><td>0</td><td>0</td><td>0</td><td>0</td><td>0</td> </tr> <tr> <td>Bit</td><td>15</td><td>14</td><td>13</td><td>12</td><td>11</td><td>10</td><td>9</td><td>8</td><td>7</td><td>6</td><td>5</td><td>4</td><td>3</td><td>2</td><td>1</td><td>0</td><td></td> </tr> </table> 0 = Input Not Activated 1 = Input Activated	Reserved	Reserved	Reserved	Reserved	Reserved	Reserved	Reserved	Reserved	Reserved	Reserved	Reserved	Reserved	Reserved	Reserved	Reserved	Input 2	Input 1	Input 0	0	0	0	0	0	0	0	0	0	0	0	0	0	0	0	0	0	0	Bit	15	14	13	12	11	10	9	8	7	6	5	4	3	2	1	0			RO	16-bit Integer
		Reserved	Reserved	Reserved	Reserved	Reserved	Reserved	Reserved	Reserved	Reserved	Reserved	Reserved	Reserved	Reserved	Reserved	Reserved	Input 2	Input 1	Input 0																																									
		0	0	0	0	0	0	0	0	0	0	0	0	0	0	0	0	0	0																																									
Bit	15	14	13	12	11	10	9	8	7	6	5	4	3	2	1	0																																												
2	 <b>Dig In Filt Mask</b> Digital Input Filter Mask Filters the selected digital input. <b>Important:</b> Only used by 11-Series I/O Module models 20-750-1133C-1R2T and 20-750-1132C-2R. (Modules with 24V DC inputs.)  Options <table border="1"> <tr> <td>Reserved</td><td>Reserved</td><td>Reserved</td><td>Reserved</td><td>Reserved</td><td>Reserved</td><td>Reserved</td><td>Reserved</td><td>Reserved</td><td>Reserved</td><td>Reserved</td><td>Reserved</td><td>Reserved</td><td>Reserved</td><td>Reserved</td><td>Input 2</td><td>Input 1</td><td>Input 0</td> </tr> <tr> <td>0</td><td>0</td><td>0</td><td>0</td><td>0</td><td>0</td><td>0</td><td>0</td><td>0</td><td>0</td><td>0</td><td>1</td><td>1</td><td>1</td><td>1</td><td>1</td><td>1</td><td>1</td> </tr> <tr> <td>Bit</td><td>15</td><td>14</td><td>13</td><td>12</td><td>11</td><td>10</td><td>9</td><td>8</td><td>7</td><td>6</td><td>5</td><td>4</td><td>3</td><td>2</td><td>1</td><td>0</td><td></td> </tr> </table> 0 = Input Not Filtered 1 = Input Filtered	Reserved	Reserved	Reserved	Reserved	Reserved	Reserved	Reserved	Reserved	Reserved	Reserved	Reserved	Reserved	Reserved	Reserved	Reserved	Input 2	Input 1	Input 0	0	0	0	0	0	0	0	0	0	0	0	1	1	1	1	1	1	1	Bit	15	14	13	12	11	10	9	8	7	6	5	4	3	2	1	0			RW	16-bit Integer		
Reserved	Reserved	Reserved	Reserved	Reserved	Reserved	Reserved	Reserved	Reserved	Reserved	Reserved	Reserved	Reserved	Reserved	Reserved	Input 2	Input 1	Input 0																																											
0	0	0	0	0	0	0	0	0	0	0	1	1	1	1	1	1	1																																											
Bit	15	14	13	12	11	10	9	8	7	6	5	4	3	2	1	0																																												
3	 <b>Dig In Filt</b> Digital Input Filter Sets the amount of filtering on the digital inputs. <b>Important:</b> Only used by 11-Series I/O Module models 20-750-1133C-1R2T and 20-750-1132C-2R. (Modules with 24V DC inputs.)	Units: mS Default: 4 Min/Max: 2 / 10	RW	32-bit Integer																																																								

File	Group	No.	Display Name Full Name Description	Values	Read-Write	Data Type																																																			
11-Series I/O	Digital Outputs	5	<b>Dig Out Sts</b> Digital Output Status Status of the digital outputs.  Options <table border="1"> <tr> <td>Reserved</td><td>Reserved</td><td>Reserved</td><td>Reserved</td><td>Reserved</td><td>Reserved</td><td>Reserved</td><td>Reserved</td><td>Reserved</td><td>Reserved</td><td>Reserved</td><td>Reserved</td><td>Reserved</td><td>Reserved</td><td>Trans Out 1<sup>(2)</sup></td><td>Trans Out 0<sup>(1)</sup></td><td>Relay Out 0</td> </tr> <tr> <td>0</td><td>0</td><td>0</td><td>0</td><td>0</td><td>0</td><td>0</td><td>0</td><td>0</td><td>0</td><td>0</td><td>0</td><td>0</td><td>0</td><td>0</td><td>0</td><td>0</td> </tr> <tr> <td>Bit</td><td>15</td><td>14</td><td>13</td><td>12</td><td>11</td><td>10</td><td>9</td><td>8</td><td>7</td><td>6</td><td>5</td><td>4</td><td>3</td><td>2</td><td>1</td><td>0</td> </tr> </table> 0 = Output De-energized 1 = Output Energized  (1) Bit 1 = "Trans Out 0" for 11-Series I/O Module model 20-750-1133C-1R2T = "Relay Out 1" for 11-Series I/O Module models 20-750-1132C-2R and 20-750-1132D-2R (2) Bit 2 is only used by 11-Series I/O Module 20-750-1133C-1R2T	Reserved	Reserved	Reserved	Reserved	Reserved	Reserved	Reserved	Reserved	Reserved	Reserved	Reserved	Reserved	Reserved	Reserved	Trans Out 1 <sup>(2)</sup>	Trans Out 0 <sup>(1)</sup>	Relay Out 0	0	0	0	0	0	0	0	0	0	0	0	0	0	0	0	0	0	Bit	15	14	13	12	11	10	9	8	7	6	5	4	3	2	1	0		RO	16-bit Integer
Reserved	Reserved	Reserved	Reserved	Reserved	Reserved	Reserved	Reserved	Reserved	Reserved	Reserved	Reserved	Reserved	Reserved	Trans Out 1 <sup>(2)</sup>	Trans Out 0 <sup>(1)</sup>	Relay Out 0																																									
0	0	0	0	0	0	0	0	0	0	0	0	0	0	0	0	0																																									
Bit	15	14	13	12	11	10	9	8	7	6	5	4	3	2	1	0																																									

File	Group	No.	Display Name Full Name Description	Values	Read-Write	Data Type																																																			
11-Series I/O	Digital Outputs	6	<b>Dig Out Invert</b> Digital Output Invert Inverts the selected digital output.  Options <table border="1"> <tr> <td></td> <td>Reserved</td><td>Reserved</td><td>Reserved</td><td>Reserved</td><td>Reserved</td><td>Reserved</td><td>Reserved</td><td>Reserved</td><td>Reserved</td><td>Reserved</td><td>Reserved</td><td>Reserved</td><td>Reserved</td><td>Trans Out 1<sup>(2)</sup></td><td>Trans Out 0<sup>(1)</sup></td><td>Relay Out 0</td> </tr> <tr> <td>Default</td> <td>0</td><td>0</td><td>0</td><td>0</td><td>0</td><td>0</td><td>0</td><td>0</td><td>0</td><td>0</td><td>0</td><td>0</td><td>0</td><td>0</td><td>0</td><td>0</td> </tr> <tr> <td>Bit</td> <td>15</td><td>14</td><td>13</td><td>12</td><td>11</td><td>10</td><td>9</td><td>8</td><td>7</td><td>6</td><td>5</td><td>4</td><td>3</td><td>2</td><td>1</td><td>0</td> </tr> </table> 0 = Output Not Inverted 1 = Output Inverted  (1) Bit 1 = "Trans Out 0" for 11-Series I/O Module model 20-750-1133C-1R2T = "Relay Out 1" for 11-Series I/O Module models 20-750-1132C-2R and 20-750-1132D-2R (2) Bit 2 is only used by 11-Series I/O Module 20-750-1133C-1R2T		Reserved	Reserved	Reserved	Reserved	Reserved	Reserved	Reserved	Reserved	Reserved	Reserved	Reserved	Reserved	Reserved	Trans Out 1 <sup>(2)</sup>	Trans Out 0 <sup>(1)</sup>	Relay Out 0	Default	0	0	0	0	0	0	0	0	0	0	0	0	0	0	0	0	Bit	15	14	13	12	11	10	9	8	7	6	5	4	3	2	1	0		RW	16-bit Integer
			Reserved	Reserved	Reserved	Reserved	Reserved	Reserved	Reserved	Reserved	Reserved	Reserved	Reserved	Reserved	Reserved	Trans Out 1 <sup>(2)</sup>	Trans Out 0 <sup>(1)</sup>	Relay Out 0																																							
		Default	0	0	0	0	0	0	0	0	0	0	0	0	0	0	0	0																																							
		Bit	15	14	13	12	11	10	9	8	7	6	5	4	3	2	1	0																																							
		7	<b>Dig Out Setpoint</b> Digital Output Setpoint Controls Relay or Transistor Outputs when chosen as the source. Can be used to control outputs from a communication device using DataLinks.  Options <table border="1"> <tr> <td></td> <td>Reserved</td><td>Reserved</td><td>Reserved</td><td>Reserved</td><td>Reserved</td><td>Reserved</td><td>Reserved</td><td>Reserved</td><td>Reserved</td><td>Reserved</td><td>Reserved</td><td>Reserved</td><td>Reserved</td><td>Trans Out 1<sup>(2)</sup></td><td>Trans Out 0<sup>(1)</sup></td><td>Relay Out 0</td> </tr> <tr> <td>Default</td> <td>0</td><td>0</td><td>0</td><td>0</td><td>0</td><td>0</td><td>0</td><td>0</td><td>0</td><td>0</td><td>0</td><td>0</td><td>0</td><td>0</td><td>0</td><td>0</td> </tr> <tr> <td>Bit</td> <td>15</td><td>14</td><td>13</td><td>12</td><td>11</td><td>10</td><td>9</td><td>8</td><td>7</td><td>6</td><td>5</td><td>4</td><td>3</td><td>2</td><td>1</td><td>0</td> </tr> </table> 0 = Output De-energized 1 = Output Energized  (1) Bit 1 = "Trans Out 0" for 11-Series I/O Module model 20-750-1133C-1R2T = "Relay Out 1" for 11-Series I/O Module models 20-750-1132C-2R and 20-750-1132D-2R (2) Bit 2 is only used by 11-Series I/O Module 20-750-1133C-1R2T		Reserved	Reserved	Reserved	Reserved	Reserved	Reserved	Reserved	Reserved	Reserved	Reserved	Reserved	Reserved	Reserved	Trans Out 1 <sup>(2)</sup>	Trans Out 0 <sup>(1)</sup>	Relay Out 0	Default	0	0	0	0	0	0	0	0	0	0	0	0	0	0	0	0	Bit	15	14	13	12	11	10	9	8	7	6	5	4	3	2	1	0		RW	16-bit Integer
	Reserved	Reserved	Reserved	Reserved	Reserved	Reserved	Reserved	Reserved	Reserved	Reserved	Reserved	Reserved	Reserved	Trans Out 1 <sup>(2)</sup>	Trans Out 0 <sup>(1)</sup>	Relay Out 0																																									
Default	0	0	0	0	0	0	0	0	0	0	0	0	0	0	0	0																																									
Bit	15	14	13	12	11	10	9	8	7	6	5	4	3	2	1	0																																									
10	<b>R00 Sel</b> Relay Output 0 Select Selects the source that will energize the relay output. Any status parameter bit can be used as an output source. For example P935 [Drive Status 1] Bit 7 "Faulted." For Torque Proving set to Port 0, parameter 1103 Bit 4. Use N.O. for safety.	Default: 0.00 (Disabled) Min/Max: 0.00 / 159999.15	RW	32-bit Integer																																																					
11	<b>R00 Level Sel</b> Relay Output 0 Level Select Selects the source of the level that will be compared.	Default: 0 (Disabled) Min/Max: 0 / 159999	RW	32-bit Integer																																																					
		<b>12</b> <b>R00 Level</b> Relay Output 0 Level Sets the level compare value.	Default: 0.0 Min/Max: -/+1000000.0	RW	Real																																																				
		<b>13</b> <b>R00 Level CmpSts</b> Relay Output 0 Level Compare Status Status of the level compare, and a possible source for a relay or transistor output. Relay Output <i>n</i> Select or Transistor Output <i>n</i> Select must have this selected to energize the output. Can be used without a physical output as status information only.  Options <table border="1"> <tr> <td></td> <td>Reserved</td><td>Reserved</td><td>Reserved</td><td>Reserved</td><td>Reserved</td><td>Reserved</td><td>Reserved</td><td>Reserved</td><td>Reserved</td><td>Reserved</td><td>Reserved</td><td>Reserved</td><td>AbsGrtThanEq</td><td>Abs Less Than</td><td>Grt Than Equ</td><td>Less Than</td> </tr> <tr> <td>Default</td> <td>0</td><td>0</td><td>0</td><td>0</td><td>0</td><td>0</td><td>0</td><td>0</td><td>0</td><td>0</td><td>0</td><td>0</td><td>0</td><td>0</td><td>0</td><td>0</td> </tr> <tr> <td>Bit</td> <td>15</td><td>14</td><td>13</td><td>12</td><td>11</td><td>10</td><td>9</td><td>8</td><td>7</td><td>6</td><td>5</td><td>4</td><td>3</td><td>2</td><td>1</td><td>0</td> </tr> </table> 0 = Condition False 1 = Condition True  Bit 0 "Less Than" – Level source is less than the level value. Bit 1 "Grt Than Equ" – Level source is greater than or equal to the level value. Bit 2 "Abs Less Than" – Absolute value of the level source is less than the absolute value of the level value. Bit 3 "AbsGrtThanEq" – Absolute value of the level source is greater than or equal to the absolute value of the level value.		Reserved	Reserved	Reserved	Reserved	Reserved	Reserved	Reserved	Reserved	Reserved	Reserved	Reserved	Reserved	AbsGrtThanEq	Abs Less Than	Grt Than Equ	Less Than	Default	0	0	0	0	0	0	0	0	0	0	0	0	0	0	0	0	Bit	15	14	13	12	11	10	9	8	7	6	5	4	3	2	1	0		RO	16-bit Integer	
	Reserved	Reserved	Reserved	Reserved	Reserved	Reserved	Reserved	Reserved	Reserved	Reserved	Reserved	Reserved	AbsGrtThanEq	Abs Less Than	Grt Than Equ	Less Than																																									
Default	0	0	0	0	0	0	0	0	0	0	0	0	0	0	0	0																																									
Bit	15	14	13	12	11	10	9	8	7	6	5	4	3	2	1	0																																									

File	Group	No.	Display Name Full Name Description	Values	Read-Write	Data Type
11-Series I/O	Digital Outputs	14	<b>R00 On Time</b> Relay Output 0 On Time Sets the "ON Delay" time for the digital outputs. This is the time between the occurrence of a condition and activation of the relay.	Units: Secs Default: 0.0 Min/Max: 0.0 / 600.0	RW	Real
		15	<b>R00 Off Time</b> Relay Output 0 Off Time Sets the "OFF Delay" time for the digital outputs. This is the time between the disappearance of a condition and de-activation of the relay.	Units: Secs Default: 0.0 Min/Max: 0.0 / 600.0	RW	Real
		20	<b>R01 Sel</b> Relay Output 1 Select – 11-Series I/O Module model 20-750-1132C-2R or 20-750-1132D-2R is installed. <b>T00 Sel</b> Transistor Output 0 Select – 11-Series I/O Module model 20-750-1133C-1R2T is installed. Selects the source that will energize the relay or transistor output. Any status parameter bit can be used as an output source. For example P935 [Drive Status 1] Bit 7 "Faulted."	Default: 0.00 (Disabled) Min/Max: 0.00 / 159999.15	RW	32-bit Integer
		21	<b>R01 Level Sel</b> Relay Output 1 Level Select – 11-Series I/O Module model 20-750-1132C-2R or 20-750-1132D-2R is installed. <b>T00 Level Sel</b> Transistor Output 0 Level Select – 11-Series I/O Module model 20-750-1133C-1R2T is installed. Selects the source of the level that will be compared.	Default: 0 (Disabled) Min/Max: 0 / 159999	RW	32-bit Integer
		22	<b>R01 Level</b> Relay Output 1 Level – 11-Series I/O Module model 20-750-1132C-2R or 20-750-1132D-2R is installed. <b>T00 Level</b> Transistor Output 0 Level – 11-Series I/O Module model 20-750-1133C-1R2T is installed. Sets the level compare value.	Default: 0.0 Min/Max: -/+1000000.0	RW	Real
		23	<b>R01 Level CmpSts</b> Relay Output 1 Level Compare Status – 11-Series I/O Module model 20-750-1132C-2R or 20-750-1132D-2R is installed. <b>T00 Level CmpSts</b> Transistor Output 0 Level Compare Status – 11-Series I/O Module model 20-750-1133C-1R2T is installed. Status of the level compare, and a possible source for a relay or transistor output. Relay Output <i>n</i> Select or Transistor Output <i>n</i> Select must have this selected to energize the output. Can be used without a physical output as status information only.	Options Reserved Reserved Reserved Reserved Reserved Reserved Reserved Reserved Reserved Reserved Reserved Reserved Reserved Reserved AbsGrtThanEq Abs Less Than Grt Than Equ Less Than Default 0 0 0 0 0 0 0 0 0 0 0 0 0 0 0 0 Bit 15 14 13 12 11 10 9 8 7 6 5 4 3 2 1 0 0 = Condition False 1 = Condition True Bit 0 "Less Than" – Level source is less than the level value. Bit 1 "Grt Than Equ" – Level source is greater than or equal to the level value. Bit 2 "Abs Less Than" – Absolute value of the level source is less than the absolute value of the level value. Bit 3 "AbsGrtThanEq" – Absolute value of the level source is greater than or equal to the absolute value of the level value.	RO	16-bit Integer
24	<b>R01 On Time</b> Relay Output 1 On Time – 11-Series I/O Module model 20-750-1132C-2R or 20-750-1132D-2R is installed. <b>T00 On Time</b> Transistor Output 0 On Time – 11-Series I/O Module model 20-750-1133C-1R2T is installed. Sets the "ON Delay" time for the digital outputs. This is the time between the occurrence of a condition and activation of the relay or transistor.	Units: Secs Default: 0.0 Min/Max: 0.0 / 600.0	RW	Real		

File	Group	No.	Display Name Full Name Description	Values	Read-Write	Data Type																																																	
11-Series I/O	Digital Outputs	25	<b>R01 Off Time</b> Relay Output 1 Off Time – 11-Series I/O Module model 20-750-1132C-2R or 20-750-1132D-2R is installed. <b>T00 Off Time</b> Transistor Output 0 Off Time – 11-Series I/O Module model 20-750-1133C-1R2T is installed. Sets the “OFF Delay” time for the digital outputs. This is the time between the disappearance of a condition and de-activation of the relay or transistor.	Units: Secs Default: 0.0 Min/Max: 0.0 / 600.0	RW	Real																																																	
		30	<b>T01 Sel</b> Transistor Output 1 Select Selects the source that will energize the transistor output. Any status parameter bit can be used as an output source. For example P935 [Drive Status 1] Bit 7 “Faulted.” <b>Important:</b> Only used by 11-Series I/O Module model 20-750-1133C-1R2T.	Default: 0 (Disabled) Min/Max: 0 / 159999	RW	32-bit Integer																																																	
		31	<b>T01 Level Sel</b> Transistor Output 1 Level Select Selects the source of the level that will be compared. <b>Important:</b> Only used by 11-Series I/O Module model 20-750-1133C-1R2T.	Default: 0 (Disabled) Min/Max: 0 / 159999	RW	32-bit Integer																																																	
		32	<b>T01 Level</b> Transistor Output 1 Level Sets the level compare value. <b>Important:</b> Only used by 11-Series I/O Module model 20-750-1133C-1R2T.	Default: 0.0 Min/Max: -/+1000000.0	RW	Real																																																	
		33	<b>T01 Level CmpSts</b> Transistor Output 1 Level Compare Status Status of the level compare, and a possible source for a transistor output. Transistor Output <i>n</i> Select must have this selected to energize the output. Can be used without a physical output as status information only. Options <table border="1" style="display: inline-table; margin-left: 20px;"> <thead> <tr> <th></th> <th>Reserved</th> <th>Reserved</th> <th>Reserved</th> <th>Reserved</th> <th>Reserved</th> <th>Reserved</th> <th>Reserved</th> <th>Reserved</th> <th>Reserved</th> <th>Reserved</th> <th>Reserved</th> <th>AbsGrtThanEq</th> <th>Abs Less Than</th> <th>Grt Than Equ</th> <th>Less Than</th> </tr> </thead> <tbody> <tr> <td>Default</td> <td>0</td> <td>0</td> <td>0</td> <td>0</td> <td>0</td> <td>0</td> <td>0</td> <td>0</td> <td>0</td> <td>0</td> <td>0</td> <td>0</td> <td>0</td> <td>0</td> <td>0</td> </tr> <tr> <td>Bit</td> <td>15</td> <td>14</td> <td>13</td> <td>12</td> <td>11</td> <td>10</td> <td>9</td> <td>8</td> <td>7</td> <td>6</td> <td>5</td> <td>4</td> <td>3</td> <td>2</td> <td>1</td> <td>0</td> </tr> </tbody> </table> 0 = Condition False 1 = Condition True Bit 0 “Less Than” – Level source is less than the level value. Bit 1 “Grt Than Equ” – Level source is greater than or equal to the level value. Bit 2 “Abs Less Than” – Absolute value of the level source is less than the absolute value of the level value. Bit 3 “AbsGrtThanEq” – Absolute value of the level source is greater than or equal to the absolute value of the level value. <b>Important:</b> Only used by 11-Series I/O Module model 20-750-1133C-1R2T.		Reserved	Reserved	Reserved	Reserved	Reserved	Reserved	Reserved	Reserved	Reserved	Reserved	Reserved	AbsGrtThanEq	Abs Less Than	Grt Than Equ	Less Than	Default	0	0	0	0	0	0	0	0	0	0	0	0	0	0	0	Bit	15	14	13	12	11	10	9	8	7	6	5	4	3	2	1	0		RO	16-bit Integer
			Reserved	Reserved	Reserved	Reserved	Reserved	Reserved	Reserved	Reserved	Reserved	Reserved	Reserved	AbsGrtThanEq	Abs Less Than	Grt Than Equ	Less Than																																						
		Default	0	0	0	0	0	0	0	0	0	0	0	0	0	0	0																																						
Bit	15	14	13	12	11	10	9	8	7	6	5	4	3	2	1	0																																							
34	<b>T01 On Time</b> Transistor Output 1 On Time Sets the “ON Delay” time for the digital outputs. This is the time between the occurrence of a condition and activation of the transistor. <b>Important:</b> Only used by 11-Series I/O Module model 20-750-1133C-1R2T.	Units: Secs Default: 0.0 Min/Max: 0.0 / 600.0	RW	Real																																																			
35	<b>T01 Off Time</b> Transistor Output 1 Off Time Sets the “OFF Delay” time for the digital outputs. This is the time between the disappearance of a condition and de-activation of the transistor. <b>Important:</b> Only used by 11-Series I/O Module model 20-750-1133C-1R2T.	Units: Secs Default: 0.0 Min/Max: 0.0 / 600.0	RW	Real																																																			

File	Group	No.	Display Name Full Name Description	Values	Read-Write	Data Type																																															
11-Series I/O	Motor PTC	41	<b>ATEX Sts</b> ATEX Status  This parameter is not latched and only displays the current status of the ATEX thermal sensor. When an ATEX fault is present, the corresponding bit value is 1. When motor temperature is within the optimal range, the bit value is 0. This parameter is available only when an ATEX option module is installed.		RO	16-bit Integer																																															
			Options <table border="1" style="width: 100%; border-collapse: collapse; text-align: center;"> <tr> <td></td> <td>Reserved</td> <td>PTC Selected</td> <td>Thermostat</td> <td>Reserved</td> <td>Reserved</td> <td>Reserved</td> <td>Reserved</td> <td>Reserved</td> <td>Reserved</td> <td>Reserved</td> <td>Reserved</td> <td>Reserved</td> <td>Voltage Loss</td> <td>Over Temp</td> <td>Short Cirk</td> <td>Thrmsnsor OK</td> </tr> <tr> <td>Default</td> <td>0</td> <td>0</td> <td>0</td> <td>0</td> <td>0</td> <td>0</td> <td>0</td> <td>0</td> <td>0</td> <td>0</td> <td>0</td> <td>0</td> <td>0</td> <td>0</td> <td>0</td> <td>0</td> </tr> <tr> <td>Bit</td> <td>15</td> <td>14</td> <td>13</td> <td>12</td> <td>11</td> <td>10</td> <td>9</td> <td>8</td> <td>7</td> <td>6</td> <td>5</td> <td>4</td> <td>3</td> <td>2</td> <td>1</td> <td>0</td> </tr> </table> <p>0 = Condition False 1 = Condition True</p> Bit 0 "Thrmsnsor OK" – Thermal sensor is Ok. Bit 1 "Short Cirk" – Short circuit fault detected by thermal sensor. Bit 2 "Over Temp" – Over temperature fault is detected by thermal sensor. Bit 3 "Voltage Loss" – Voltage loss fault has taken place on ATEX board. Bit 13 "Thermostat" – Thermostat input has been selected. Bit 14 "PTC Selected" – PTC input has been selected.		Reserved	PTC Selected	Thermostat	Reserved	Reserved	Reserved	Reserved	Reserved	Reserved	Reserved	Reserved	Reserved	Voltage Loss	Over Temp	Short Cirk	Thrmsnsor OK	Default	0	0	0	0	0	0	0	0	0	0	0	0	0	0	0	0	Bit	15	14	13	12	11	10	9	8	7	6	5	4	3	2	1
	Reserved	PTC Selected	Thermostat	Reserved	Reserved	Reserved	Reserved	Reserved	Reserved	Reserved	Reserved	Reserved	Voltage Loss	Over Temp	Short Cirk	Thrmsnsor OK																																					
Default	0	0	0	0	0	0	0	0	0	0	0	0	0	0	0	0																																					
Bit	15	14	13	12	11	10	9	8	7	6	5	4	3	2	1	0																																					



File	Group	No.	Display Name Full Name Description	Values	Read-Write	Data Type																																																						
11-Series I/O	Analog Inputs	45	<b>Anlg In Type</b> Analog Input Type Status of the analog input mode set by the option jumpers.	<table border="1"> <thead> <tr> <th>Options</th> <th>Reserved</th><th>Reserved</th><th>Reserved</th><th>Reserved</th><th>Reserved</th><th>Reserved</th><th>Reserved</th><th>Reserved</th><th>Reserved</th><th>Reserved</th><th>Reserved</th><th>Reserved</th><th>Reserved</th><th>Reserved</th><th>Reserved</th><th>Reserved</th><th>Analog 0</th> </tr> </thead> <tbody> <tr> <td>Default</td> <td>0</td><td>0</td><td>0</td><td>0</td><td>0</td><td>0</td><td>0</td><td>0</td><td>0</td><td>0</td><td>0</td><td>0</td><td>0</td><td>0</td><td>0</td><td>0</td><td>0</td> </tr> <tr> <td>Bit</td> <td>15</td><td>14</td><td>13</td><td>12</td><td>11</td><td>10</td><td>9</td><td>8</td><td>7</td><td>6</td><td>5</td><td>4</td><td>3</td><td>2</td><td>1</td><td>0</td><td></td> </tr> </tbody> </table> <p>0 = Voltage Mode 1 = Current Mode</p>	Options	Reserved	Reserved	Reserved	Reserved	Reserved	Reserved	Reserved	Reserved	Reserved	Reserved	Reserved	Reserved	Reserved	Reserved	Reserved	Reserved	Analog 0	Default	0	0	0	0	0	0	0	0	0	0	0	0	0	0	0	0	0	Bit	15	14	13	12	11	10	9	8	7	6	5	4	3	2	1	0		RO	16-bit Integer
		Options	Reserved	Reserved	Reserved	Reserved	Reserved	Reserved	Reserved	Reserved	Reserved	Reserved	Reserved	Reserved	Reserved	Reserved	Reserved	Reserved	Analog 0																																									
		Default	0	0	0	0	0	0	0	0	0	0	0	0	0	0	0	0	0																																									
Bit	15	14	13	12	11	10	9	8	7	6	5	4	3	2	1	0																																												
46	<b>Anlg In Sqrt</b> Analog Input Square Root Enables/disables the square root function for each input.	<table border="1"> <thead> <tr> <th>Options</th> <th>Reserved</th><th>Reserved</th><th>Reserved</th><th>Reserved</th><th>Reserved</th><th>Reserved</th><th>Reserved</th><th>Reserved</th><th>Reserved</th><th>Reserved</th><th>Reserved</th><th>Reserved</th><th>Reserved</th><th>Reserved</th><th>Reserved</th><th>Reserved</th><th>Analog 0</th> </tr> </thead> <tbody> <tr> <td>Default</td> <td>0</td><td>0</td><td>0</td><td>0</td><td>0</td><td>0</td><td>0</td><td>0</td><td>0</td><td>0</td><td>0</td><td>0</td><td>0</td><td>0</td><td>0</td><td>0</td><td>0</td> </tr> <tr> <td>Bit</td> <td>15</td><td>14</td><td>13</td><td>12</td><td>11</td><td>10</td><td>9</td><td>8</td><td>7</td><td>6</td><td>5</td><td>4</td><td>3</td><td>2</td><td>1</td><td>0</td><td></td> </tr> </tbody> </table> <p>0 = Square Root Disabled 1 = Square Root Enabled</p>	Options	Reserved	Reserved	Reserved	Reserved	Reserved	Reserved	Reserved	Reserved	Reserved	Reserved	Reserved	Reserved	Reserved	Reserved	Reserved	Reserved	Analog 0	Default	0	0	0	0	0	0	0	0	0	0	0	0	0	0	0	0	0	Bit	15	14	13	12	11	10	9	8	7	6	5	4	3	2	1	0		RW	16-bit Integer		
Options	Reserved	Reserved	Reserved	Reserved	Reserved	Reserved	Reserved	Reserved	Reserved	Reserved	Reserved	Reserved	Reserved	Reserved	Reserved	Reserved	Analog 0																																											
Default	0	0	0	0	0	0	0	0	0	0	0	0	0	0	0	0	0																																											
Bit	15	14	13	12	11	10	9	8	7	6	5	4	3	2	1	0																																												
47	<b>Anlg In Loss Sts</b> Analog Input Loss Status Status of the analog input loss.	<table border="1"> <thead> <tr> <th>Options</th> <th>Reserved</th><th>Reserved</th><th>Reserved</th><th>Reserved</th><th>Reserved</th><th>Reserved</th><th>Reserved</th><th>Reserved</th><th>Reserved</th><th>Reserved</th><th>Reserved</th><th>Reserved</th><th>Reserved</th><th>Reserved</th><th>Loss0</th><th>Loss</th> </tr> </thead> <tbody> <tr> <td>Default</td> <td>0</td><td>0</td><td>0</td><td>0</td><td>0</td><td>0</td><td>0</td><td>0</td><td>0</td><td>0</td><td>0</td><td>0</td><td>0</td><td>0</td><td>0</td><td>0</td> </tr> <tr> <td>Bit</td> <td>15</td><td>14</td><td>13</td><td>12</td><td>11</td><td>10</td><td>9</td><td>8</td><td>7</td><td>6</td><td>5</td><td>4</td><td>3</td><td>2</td><td>1</td><td>0</td> </tr> </tbody> </table> <p>0 = No Loss 1 = Loss Detected</p> <p>Bit 0 "Loss" – Indicates loss of input. Bit 1 "Loss0" – Indicates loss of input.</p>	Options	Reserved	Reserved	Reserved	Reserved	Reserved	Reserved	Reserved	Reserved	Reserved	Reserved	Reserved	Reserved	Reserved	Reserved	Loss0	Loss	Default	0	0	0	0	0	0	0	0	0	0	0	0	0	0	0	0	Bit	15	14	13	12	11	10	9	8	7	6	5	4	3	2	1	0	RO	16-bit Integer					
Options	Reserved	Reserved	Reserved	Reserved	Reserved	Reserved	Reserved	Reserved	Reserved	Reserved	Reserved	Reserved	Reserved	Reserved	Loss0	Loss																																												
Default	0	0	0	0	0	0	0	0	0	0	0	0	0	0	0	0																																												
Bit	15	14	13	12	11	10	9	8	7	6	5	4	3	2	1	0																																												

File	Group	No.	Display Name Full Name Description	Values	Read-Write	Data Type
11-Series I/O	Analog Inputs	50	<b>Anlg In0 Value</b> Analog Input 0 Value Value of the Analog input after filter, square root, and loss action.	Units: Volt mA Default: 0.000 Volts 0.000 mA Min/Max: -/+10.000 Volts 0.000 / 20.000 mA	RO	Real
		51	<b>Anlg In0 Hi</b> Analog Input 0 High Sets the highest input value to the analog input scaling block.	Units: Volt mA Default: 10.000 Volts 20.000 mA Min/Max: -/+10.000 Volts 0.000 / 20.000 mA	RW	Real
		52	<b>Anlg In0 Lo</b> Analog Input 0 Low Sets the lowest input value to the analog input scaling block.	Units: Volt mA Default: 0.000 Volts 0.000 mA Min/Max: -/+10.000 Volts 0.000 / 20.000 mA	RW	Real
		53	<b>Anlg In0 LssActn</b> Analog Input 0 Loss Action Selects drive action when an analog signal loss is detected. Signal loss is defined as an analog signal less than 1V or 2mA. The signal loss event ends and normal operation resumes when the input signal level is greater than or equal to 1.5V or 3mA. "Ignore" (0) – No action is taken. "Alarm" (1) – Type 1 alarm indicated. "Flt Minor" (2) – Minor fault indicated. If running, drive continues to run. Enable with P950 [Minor Flt Cfg]. If not enabled, acts like a major fault. "FltCoastStop" (3) – Major fault indicated. Coast to Stop. "Flt RampStop" (4) – Major fault indicated. Ramp to Stop. "Flt CL Stop" (5) – Major fault indicated. Current Limit Stop. "Hold Input" (6) – Holds input at last value. "Set Input Lo" (7) – Sets input to P52 [Anlg In0 Lo]. "Set Input Hi" (8) – Sets input to P51 [Anlg In0 Hi].	Default: 0 = "Ignore" Options: 0 = "Ignore" 1 = "Alarm" 2 = "Flt Minor" 3 = "FltCoastStop" 4 = "Flt RampStop" 5 = "Flt CL Stop" 6 = "Hold Input" 7 = "Set Input Lo" 8 = "Set Input Hi"	RW	32-bit Integer
		54	<b>Anlg In0 Raw Val</b> Analog Input 0 Raw Value Raw Value of the analog input.	Units: Volt mA Default: 0.000 Volts 0.000 mA Min/Max: -/+10.000 Volts 0.000 / 20.000 mA	RO	Real
		55	<b>Anlg In0 Filt Gn</b> Analog Input 0 Filter Gain Sets the analog input filter gain. Recommended settings:	Default: 1.00 Min/Max: -/+5.00	RW	Real
		56	<b>Anlg In0 Filt BW</b> Analog Input 0 Filter Bandwidth Sets the analog input filter bandwidth. Recommended settings:	Default: 0.0 Min/Max: 0.0 / 500.0	RW	Real

File	Group	No.	Display Name Full Name Description	Values	Read-Write	Data Type																																																			
11-Series I/O	Analog Outputs	70	<b>Anlg Out Type</b> Analog Output Type Select the analog output mode for each analog output.  Options <table border="1"> <tr> <td></td> <td>Reserved</td><td>Reserved</td><td>Reserved</td><td>Reserved</td><td>Reserved</td><td>Reserved</td><td>Reserved</td><td>Reserved</td><td>Reserved</td><td>Reserved</td><td>Reserved</td><td>Reserved</td><td>Reserved</td><td>Reserved</td><td>Reserved</td><td>Analog 0</td> </tr> <tr> <td>Default</td> <td>0</td><td>0</td><td>0</td><td>0</td><td>0</td><td>0</td><td>0</td><td>0</td><td>0</td><td>0</td><td>0</td><td>0</td><td>0</td><td>0</td><td>0</td><td>0</td> </tr> <tr> <td>Bit</td> <td>15</td><td>14</td><td>13</td><td>12</td><td>11</td><td>10</td><td>9</td><td>8</td><td>7</td><td>6</td><td>5</td><td>4</td><td>3</td><td>2</td><td>1</td><td>0</td> </tr> </table>		Reserved	Reserved	Reserved	Reserved	Reserved	Reserved	Reserved	Reserved	Reserved	Reserved	Reserved	Reserved	Reserved	Reserved	Reserved	Analog 0	Default	0	0	0	0	0	0	0	0	0	0	0	0	0	0	0	0	Bit	15	14	13	12	11	10	9	8	7	6	5	4	3	2	1	0	0 = Voltage Mode 1 = Current Mode	RW	16-bit Integer
			Reserved	Reserved	Reserved	Reserved	Reserved	Reserved	Reserved	Reserved	Reserved	Reserved	Reserved	Reserved	Reserved	Reserved	Reserved	Analog 0																																							
		Default	0	0	0	0	0	0	0	0	0	0	0	0	0	0	0	0																																							
		Bit	15	14	13	12	11	10	9	8	7	6	5	4	3	2	1	0																																							
		71	<b>Anlg Out Abs</b> Analog Output Absolute Selects whether the signed value or absolute value of a parameter is used before being scaled to drive the analog output.  Options <table border="1"> <tr> <td></td> <td>Reserved</td><td>Reserved</td><td>Reserved</td><td>Reserved</td><td>Reserved</td><td>Reserved</td><td>Reserved</td><td>Reserved</td><td>Reserved</td><td>Reserved</td><td>Reserved</td><td>Reserved</td><td>Reserved</td><td>Reserved</td><td>Reserved</td><td>Analog 0</td> </tr> <tr> <td>Default</td> <td>0</td><td>0</td><td>0</td><td>0</td><td>0</td><td>0</td><td>0</td><td>0</td><td>0</td><td>0</td><td>0</td><td>0</td><td>0</td><td>0</td><td>1</td><td>1</td> </tr> <tr> <td>Bit</td> <td>15</td><td>14</td><td>13</td><td>12</td><td>11</td><td>10</td><td>9</td><td>8</td><td>7</td><td>6</td><td>5</td><td>4</td><td>3</td><td>2</td><td>1</td><td>0</td> </tr> </table>		Reserved	Reserved	Reserved	Reserved	Reserved	Reserved	Reserved	Reserved	Reserved	Reserved	Reserved	Reserved	Reserved	Reserved	Reserved	Analog 0	Default	0	0	0	0	0	0	0	0	0	0	0	0	0	0	1	1	Bit	15	14	13	12	11	10	9	8	7	6	5	4	3	2	1	0	0 = Condition False 1 = Condition True	RW	16-bit Integer
			Reserved	Reserved	Reserved	Reserved	Reserved	Reserved	Reserved	Reserved	Reserved	Reserved	Reserved	Reserved	Reserved	Reserved	Reserved	Analog 0																																							
		Default	0	0	0	0	0	0	0	0	0	0	0	0	0	0	1	1																																							
		Bit	15	14	13	12	11	10	9	8	7	6	5	4	3	2	1	0																																							
		75	<b>Anlg Out0 Sel</b> Analog Output 0 Select Selects the source for the analog output.	Default: 3 Min/Max: 0 / 159999	RW	32-bit Integer																																																			
76	<b>Anlg Out0 Stpt</b> Analog Output 0 Setpoint A possible source for an analog output. Can be used to control an analog output from a communication device using a DataLink. Not affected by analog output scaling.	Units: Volt mA Default: 10.000 Volts 20.000 mA Min/Max: -/+10.000 Volts 0.000 / 20.000 mA	RW	Real																																																					
77	<b>Anlg Out0 Data</b> Analog Output 0 Data Displays the value of the source selected by P75 [Anlg Out0 Sel].	Default: 0 Min/Max: -/+100000	RO	Real																																																					
78	<b>Anlg Out0 DataHi</b> Analog Output 0 Data High Sets the high value for the data range of analog out scale.	Units: pu Default: 1 Min/Max: -/+21474800	RW	Real																																																					
79	<b>Anlg Out0 DataLo</b> Analog Output 0 Data Low Sets the low value for the data range of analog out scale.	Default: 1 Min/Max: -/+21474800	RW	Real																																																					
80	<b>Anlg Out0 Hi</b> Analog Output 0 High Sets the high value for the analog output value when the data value is at its maximum.	Units: Volt mA Default: 10.000 Volts 20.000 mA Min/Max: -/+10.000 Volts 0.000 / 20.000 mA	RW	Real																																																					
81	<b>Anlg Out0 Lo</b> Analog Output 0 Low Sets the low value for the analog output value when the data value is at its minimum.	Units: Volt mA Default: 10.000 Volts 20.000 mA Min/Max: -/+10.000 Volts 0.000 / 20.000 mA	RW	Real																																																					



File	Group	No.	Display Name Full Name Description	Values	Read-Write	Data Type
11-Series I/O	Analog Outputs	82	<b>Anlg Out0 Val</b> Analog Output 0 Value Displays the analog output value.	Units: Volt mA Default: 10.000 Volts 20.000 mA Min/Max: -/+10.000 Volts 0.000 / 20.000 mA	RO	Real

File	Group	No.	Display Name Full Name Description	Values	Read-Write	Data Type																																																			
11-Series I/O	Predictive Main	99	<b>PredMaint Sts</b> Predictive Maintenance Status Status of relay's predictive maintenance.  Options <table border="1" style="display: inline-table; vertical-align: middle;"> <tr> <td></td> <td>Master</td> <td>Reserved</td> <td>Reserved</td> <td>Reserved</td> <td>Reserved</td> <td>Reserved</td> <td>Reserved</td> <td>Reserved</td> <td>Reserved</td> <td>Reserved</td> <td>Reserved</td> <td>Reserved</td> <td>Reserved</td> <td>Reserved</td> <td>Relay Out 0<sup>(1)</sup></td> <td>Relay Out 0</td> </tr> <tr> <td>Default</td> <td>0</td> <td>0</td> <td>0</td> <td>0</td> <td>0</td> <td>0</td> <td>0</td> <td>0</td> <td>0</td> <td>0</td> <td>0</td> <td>0</td> <td>0</td> <td>0</td> <td>0</td> <td>0</td> </tr> <tr> <td>Bit</td> <td>15</td> <td>14</td> <td>13</td> <td>12</td> <td>11</td> <td>10</td> <td>9</td> <td>8</td> <td>7</td> <td>6</td> <td>5</td> <td>4</td> <td>3</td> <td>2</td> <td>1</td> <td>0</td> </tr> </table>		Master	Reserved	Reserved	Reserved	Reserved	Reserved	Reserved	Reserved	Reserved	Reserved	Reserved	Reserved	Reserved	Reserved	Relay Out 0 <sup>(1)</sup>	Relay Out 0	Default	0	0	0	0	0	0	0	0	0	0	0	0	0	0	0	0	Bit	15	14	13	12	11	10	9	8	7	6	5	4	3	2	1	0	0 = Condition False 1 = Condition True	RO	16-bit Integer
			Master	Reserved	Reserved	Reserved	Reserved	Reserved	Reserved	Reserved	Reserved	Reserved	Reserved	Reserved	Reserved	Reserved	Relay Out 0 <sup>(1)</sup>	Relay Out 0																																							
		Default	0	0	0	0	0	0	0	0	0	0	0	0	0	0	0	0																																							
		Bit	15	14	13	12	11	10	9	8	7	6	5	4	3	2	1	0																																							
		100	<b>R00 Load Type</b> Relay Output 0 Load Type Sets the type of load that will be applied to the relay. Must be properly set for the Predictive Maintenance function to predict the relay life.	Default: 1 = "DC Inductive" Options: 0 = "DC Resistive" 1 = "DC Inductive" 2 = "AC Resistive" 3 = "AC Inductive"	RW	32-bit Integer																																																			
		101	<b>R00 Load Amps</b> Relay Output 0 Load Amps Load current that will be applied to the relay contacts. Must be properly set for the Predictive Maintenance function to approximate the relay life.	Units: Amps Default: 2.000 Min/Max: 0.000 / 2.000	RW	Real																																																			
		102	<b>R00 TotalLife</b> Relay Output 0 Total Life Total life cycles of the relay based on programmed load type and amps.	Units: Cycl Default: 0 Min/Max: 0 / 2147483647	RO	32-bit Integer																																																			
103	<b>R00 ElapsedLife</b> Relay Output 0 Elapsed Life Non-resettable, total accumulated cycles of the relay.	Units: Cycl Default: 0 Min/Max: 0 / 2147483647	RO	32-bit Integer																																																					
104	<b>R00 RemainLife</b> Relay Output 0 Remaining Life The difference between the Total Life and the Elapsed Life.	Units: Cycl Default: 0 Min/Max: 0 / 2147483647	RO	32-bit Integer																																																					
105	<b>R00 LifeEvtLvl</b> Relay Output 0 Life Event Level Sets the percentage of relay life cycles before action is taken.	Units: % Default: 80.000 Min/Max: 0.000 / 100.000	RW	Real																																																					

(1) Bit 1 = "Relay Out 0" for 11-Series I/O Module models 20-750-1132C-2R and 20-750-1132D-2R

File	Group	No.	Display Name Full Name Description	Values	Read-Write	Data Type
11-Series I/O	Predictive Main	106	<b>R00 LifeEvtActn</b> Relay Output 0 Life Event Action Sets the action that will be taken when the percentage of relay life cycles has been reached. "Ignore" (0) – No action is taken. "Alarm" (1) – Type 1 alarm indicated. "Flt Minor" (2) – Minor fault indicated. If running, drive continues to run. Enable with P950 [Minor Flt Cfg]. If not enabled, acts like a major fault. "FltCoastStop" (3) – Major fault indicated. Coast to Stop. "Flt RampStop" (4) – Major fault indicated. Ramp to Stop. "Flt CL Stop" (5) – Major fault indicated. Current Limit Stop.	Default: 1 = "Alarm" Options: 0 = "Ignore" 1 = "Alarm" 2 = "Flt Minor" 3 = "FltCoastStop" 4 = "Flt RampStop" 5 = "Flt CL Stop"	RW	32-bit Integer
		110	<b>R01 Load Type</b> Relay Output 1 Load Type Sets the type of load that will be applied to the relay. Must be properly set for the Predictive Maintenance function to predict the relay life. <b>Important:</b> Only used by 11-Series I/O Module models 20-750-1132C-2R and 20-750-1132D-2R.	Default: 1 = "DC Inductive" Options: 0 = "DC Resistive" 1 = "DC Inductive" 2 = "AC Resistive" 3 = "AC Inductive"	RW	32-bit Integer
		111	<b>R01 Load Amps</b> Relay Output 1 Load Amps Load current that will be applied to the relay contacts. Must be properly set for the Predictive Maintenance function to approximate the relay life. <b>Important:</b> Only used by 11-Series I/O Module models 20-750-1132C-2R and 20-750-1132D-2R.	Units: Amps Default: 2.000 Min/Max: 0.000 / 2.000	RW	Real
		112	<b>R01 TotalLife</b> Relay Output 1 Total Life Total life cycles of the relay based on programmed load type and amps. <b>Important:</b> Only used by 11-Series I/O Module models 20-750-1132C-2R and 20-750-1132D-2R.	Units: Cycl Default: 0 Min/Max: 0 / 2147483647	RO	32-bit Integer
		113	<b>R01 ElapsedLife</b> Relay Output 1 Elapsed Life Non-resettable, total accumulated cycles of the relay. <b>Important:</b> Only used by 11-Series I/O Module models 20-750-1132C-2R and 20-750-1132D-2R.	Units: Cycl Default: 0 Min/Max: 0 / 2147483647	RO	32-bit Integer
		114	<b>R01 RemainLife</b> Relay Output 1 Remaining Life The difference between the Total Life and the Elapsed Life. <b>Important:</b> Only used by 11-Series I/O Module models 20-750-1132C-2R and 20-750-1132D-2R.	Units: Cycl Default: 0 Min/Max: 0 / 2147483647	RO	32-bit Integer
		115	<b>R01 LifeEvtLvl</b> Relay Output 1 Life Event Level Sets the percentage of relay life cycles before action is taken. <b>Important:</b> Only used by 11-Series I/O Module models 20-750-1132C-2R and 20-750-1132D-2R.	Units: % Default: 80.000 Min/Max: 0.000 / 100.000	RW	Real
		116	<b>R01 LifeEvtActn</b> Relay Output 1 Life Event Action Sets the action that will be taken when the percentage of relay life cycles has been reached. <b>Important:</b> Only used by 11-Series I/O Module models 20-750-1132C-2R and 20-750-1132D-2R. "Ignore" (0) – No action is taken. "Alarm" (1) – Type 1 alarm indicated. "Flt Minor" (2) – Minor fault indicated. If running, drive continues to run. Enable with P950 [Minor Flt Cfg]. If not enabled, acts like a major fault. "FltCoastStop" (3) – Major fault indicated. Coast to Stop. "Flt RampStop" (4) – Major fault indicated. Ramp to Stop. "Flt CL Stop" (5) – Major fault indicated. Current Limit Stop.	Default: 1 = "Alarm" Options: 0 = "Ignore" 1 = "Alarm" 2 = "Flt Minor" 3 = "FltCoastStop" 4 = "Flt RampStop" 5 = "Flt CL Stop"	RW	32-bit Integer

## 22-Series I/O Module Parameters

File	Group	No.	Display Name Full Name Description	Values	Read-Write	Data Type																																																																																										
22-Series I/O	Digital Inputs	1	<b>Dig In Sts</b> Digital Input Status Status of the digital inputs.  Options <table border="1"> <tr> <td>Reserved</td><td>Reserved</td><td>Reserved</td><td>Reserved</td><td>Reserved</td><td>Reserved</td><td>Reserved</td><td>Reserved</td><td>Reserved</td><td>Reserved</td><td>Reserved</td><td>Reserved</td><td>Input 5</td><td>Input 4</td><td>Input 3</td><td>Input 2</td><td>Input 1</td><td>Input 0</td> </tr> <tr> <td>0</td><td>0</td><td>0</td><td>0</td><td>0</td><td>0</td><td>0</td><td>0</td><td>0</td><td>0</td><td>0</td><td>0</td><td>0</td><td>0</td><td>0</td><td>0</td><td>0</td><td>0</td> </tr> <tr> <td>15</td><td>14</td><td>13</td><td>12</td><td>11</td><td>10</td><td>9</td><td>8</td><td>7</td><td>6</td><td>5</td><td>4</td><td>3</td><td>2</td><td>1</td><td>0</td><td></td><td></td> </tr> </table> Default <table border="1"> <tr> <td>0</td><td>0</td><td>0</td><td>0</td><td>0</td><td>0</td><td>0</td><td>0</td><td>0</td><td>0</td><td>0</td><td>0</td><td>0</td><td>0</td><td>0</td><td>0</td><td>0</td><td>0</td> </tr> </table> Bit <table border="1"> <tr> <td>15</td><td>14</td><td>13</td><td>12</td><td>11</td><td>10</td><td>9</td><td>8</td><td>7</td><td>6</td><td>5</td><td>4</td><td>3</td><td>2</td><td>1</td><td>0</td><td></td><td></td> </tr> </table> 0 = Input Not Activated 1 = Input Activated	Reserved	Reserved	Reserved	Reserved	Reserved	Reserved	Reserved	Reserved	Reserved	Reserved	Reserved	Reserved	Input 5	Input 4	Input 3	Input 2	Input 1	Input 0	0	0	0	0	0	0	0	0	0	0	0	0	0	0	0	0	0	0	15	14	13	12	11	10	9	8	7	6	5	4	3	2	1	0			0	0	0	0	0	0	0	0	0	0	0	0	0	0	0	0	0	0	15	14	13	12	11	10	9	8	7	6	5	4	3	2	1	0				RO	16-bit Integer
		Reserved	Reserved	Reserved	Reserved	Reserved	Reserved	Reserved	Reserved	Reserved	Reserved	Reserved	Reserved	Input 5	Input 4	Input 3	Input 2	Input 1	Input 0																																																																													
		0	0	0	0	0	0	0	0	0	0	0	0	0	0	0	0	0	0																																																																													
15	14	13	12	11	10	9	8	7	6	5	4	3	2	1	0																																																																																	
0	0	0	0	0	0	0	0	0	0	0	0	0	0	0	0	0	0																																																																															
15	14	13	12	11	10	9	8	7	6	5	4	3	2	1	0																																																																																	
2	 <b>Dig In Filt Mask</b> Digital Input Filter Mask Filters the selected digital input. <b>Important:</b> Only used by 22-Series I/O Module models 20-750-2263C-1R2T and 20-750-2262C-2R. (Modules with 24V DC inputs.)  Options <table border="1"> <tr> <td>Reserved</td><td>Reserved</td><td>Reserved</td><td>Reserved</td><td>Reserved</td><td>Reserved</td><td>Reserved</td><td>Reserved</td><td>Reserved</td><td>Reserved</td><td>Reserved</td><td>Input 5</td><td>Input 4</td><td>Input 3</td><td>Input 2</td><td>Input 1</td><td>Input 0</td> </tr> <tr> <td>0</td><td>0</td><td>0</td><td>0</td><td>0</td><td>0</td><td>0</td><td>0</td><td>0</td><td>0</td><td>0</td><td>1</td><td>1</td><td>1</td><td>1</td><td>1</td><td>1</td> </tr> <tr> <td>15</td><td>14</td><td>13</td><td>12</td><td>11</td><td>10</td><td>9</td><td>8</td><td>7</td><td>6</td><td>5</td><td>4</td><td>3</td><td>2</td><td>1</td><td>0</td><td></td> </tr> </table> Default <table border="1"> <tr> <td>0</td><td>0</td><td>0</td><td>0</td><td>0</td><td>0</td><td>0</td><td>0</td><td>0</td><td>0</td><td>0</td><td>1</td><td>1</td><td>1</td><td>1</td><td>1</td><td>1</td> </tr> </table> Bit <table border="1"> <tr> <td>15</td><td>14</td><td>13</td><td>12</td><td>11</td><td>10</td><td>9</td><td>8</td><td>7</td><td>6</td><td>5</td><td>4</td><td>3</td><td>2</td><td>1</td><td>0</td><td></td> </tr> </table> 0 = Input Not Filtered 1 = Input Filtered	Reserved	Reserved	Reserved	Reserved	Reserved	Reserved	Reserved	Reserved	Reserved	Reserved	Reserved	Input 5	Input 4	Input 3	Input 2	Input 1	Input 0	0	0	0	0	0	0	0	0	0	0	0	1	1	1	1	1	1	15	14	13	12	11	10	9	8	7	6	5	4	3	2	1	0		0	0	0	0	0	0	0	0	0	0	0	1	1	1	1	1	1	15	14	13	12	11	10	9	8	7	6	5	4	3	2	1	0			RW	16-bit Integer							
Reserved	Reserved	Reserved	Reserved	Reserved	Reserved	Reserved	Reserved	Reserved	Reserved	Reserved	Input 5	Input 4	Input 3	Input 2	Input 1	Input 0																																																																																
0	0	0	0	0	0	0	0	0	0	0	1	1	1	1	1	1																																																																																
15	14	13	12	11	10	9	8	7	6	5	4	3	2	1	0																																																																																	
0	0	0	0	0	0	0	0	0	0	0	1	1	1	1	1	1																																																																																
15	14	13	12	11	10	9	8	7	6	5	4	3	2	1	0																																																																																	
3	 <b>Dig In Filt</b> Digital Input Filter Sets the amount of filtering on the digital inputs. <b>Important:</b> Only used by 22-Series I/O Module models 20-750-2263C-1R2T and 20-750-2262C-2R. (Modules with 24V DC inputs.)	Units: mS Default: 4 Min/Max: 2 / 10	RW	32-bit Integer																																																																																												

File	Group	No.	Display Name Full Name Description	Values	Read-Write	Data Type																																																																																					
22-Series I/O	Digital Outputs	5	<b>Dig Out Sts</b> Digital Output Status Status of the digital outputs.  Options <table border="1"> <tr> <td>Reserved</td><td>Reserved</td><td>Reserved</td><td>Reserved</td><td>Reserved</td><td>Reserved</td><td>Reserved</td><td>Reserved</td><td>Reserved</td><td>Reserved</td><td>Reserved</td><td>Reserved</td><td>Reserved</td><td>Reserved</td><td>Trans Out 1<sup>(2)</sup></td><td>Trans Out 0<sup>(1)</sup></td><td>Relay Out 0</td> </tr> <tr> <td>0</td><td>0</td><td>0</td><td>0</td><td>0</td><td>0</td><td>0</td><td>0</td><td>0</td><td>0</td><td>0</td><td>0</td><td>0</td><td>0</td><td>0</td><td>0</td><td>0</td> </tr> <tr> <td>15</td><td>14</td><td>13</td><td>12</td><td>11</td><td>10</td><td>9</td><td>8</td><td>7</td><td>6</td><td>5</td><td>4</td><td>3</td><td>2</td><td>1</td><td>0</td><td></td> </tr> </table> Default <table border="1"> <tr> <td>0</td><td>0</td><td>0</td><td>0</td><td>0</td><td>0</td><td>0</td><td>0</td><td>0</td><td>0</td><td>0</td><td>0</td><td>0</td><td>0</td><td>0</td><td>0</td><td>0</td> </tr> </table> Bit <table border="1"> <tr> <td>15</td><td>14</td><td>13</td><td>12</td><td>11</td><td>10</td><td>9</td><td>8</td><td>7</td><td>6</td><td>5</td><td>4</td><td>3</td><td>2</td><td>1</td><td>0</td><td></td> </tr> </table> 0 = Output De-energized 1 = Output Energized  (1) Bit 1 = "Trans Out 0" for 22-Series I/O Module model 20-750-2263C-1R2T = "Relay Out 1" for 22-Series I/O Module models 20-750-2262C-2R and 20-750-2262D-2R (2) Bit 2 is only used by 22-Series I/O Module 20-750-2263C-1R2T	Reserved	Reserved	Reserved	Reserved	Reserved	Reserved	Reserved	Reserved	Reserved	Reserved	Reserved	Reserved	Reserved	Reserved	Trans Out 1 <sup>(2)</sup>	Trans Out 0 <sup>(1)</sup>	Relay Out 0	0	0	0	0	0	0	0	0	0	0	0	0	0	0	0	0	0	15	14	13	12	11	10	9	8	7	6	5	4	3	2	1	0		0	0	0	0	0	0	0	0	0	0	0	0	0	0	0	0	0	15	14	13	12	11	10	9	8	7	6	5	4	3	2	1	0			RO	16-bit Integer
Reserved	Reserved	Reserved	Reserved	Reserved	Reserved	Reserved	Reserved	Reserved	Reserved	Reserved	Reserved	Reserved	Reserved	Trans Out 1 <sup>(2)</sup>	Trans Out 0 <sup>(1)</sup>	Relay Out 0																																																																											
0	0	0	0	0	0	0	0	0	0	0	0	0	0	0	0	0																																																																											
15	14	13	12	11	10	9	8	7	6	5	4	3	2	1	0																																																																												
0	0	0	0	0	0	0	0	0	0	0	0	0	0	0	0	0																																																																											
15	14	13	12	11	10	9	8	7	6	5	4	3	2	1	0																																																																												

File	Group	No.	Display Name Full Name Description	Values	Read-Write	Data Type																																																						
22-Series I/O	Digital Outputs	6	<b>Dig Out Invert</b> Digital Output Invert Inverts the selected digital output.  Options <table border="1"> <tr> <td></td> <td>Reserved</td><td>Reserved</td><td>Reserved</td><td>Reserved</td><td>Reserved</td><td>Reserved</td><td>Reserved</td><td>Reserved</td><td>Reserved</td><td>Reserved</td><td>Reserved</td><td>Reserved</td><td>Reserved</td><td>Reserved</td><td>Trans Out 1<sup>(2)</sup></td><td>Trans Out 0<sup>(1)</sup></td><td>Relay Out 0</td> </tr> <tr> <td>Default</td> <td>0</td><td>0</td><td>0</td><td>0</td><td>0</td><td>0</td><td>0</td><td>0</td><td>0</td><td>0</td><td>0</td><td>0</td><td>0</td><td>0</td><td>0</td><td>0</td><td>0</td> </tr> <tr> <td>Bit</td> <td>15</td><td>14</td><td>13</td><td>12</td><td>11</td><td>10</td><td>9</td><td>8</td><td>7</td><td>6</td><td>5</td><td>4</td><td>3</td><td>2</td><td>1</td><td>0</td><td></td> </tr> </table> 0 = Output Not Inverted 1 = Output Inverted  (1) Bit 1 = "Trans Out 0" for 22-Series I/O Module model 20-750-2263C-1R2T = "Relay Out 1" for 22-Series I/O Module models 20-750-2262C-2R and 20-750-2262D-2R (2) Bit 2 is only used by 22-Series I/O Module 20-750-2263C-1R2T		Reserved	Reserved	Reserved	Reserved	Reserved	Reserved	Reserved	Reserved	Reserved	Reserved	Reserved	Reserved	Reserved	Reserved	Trans Out 1 <sup>(2)</sup>	Trans Out 0 <sup>(1)</sup>	Relay Out 0	Default	0	0	0	0	0	0	0	0	0	0	0	0	0	0	0	0	0	Bit	15	14	13	12	11	10	9	8	7	6	5	4	3	2	1	0			RW	16-bit Integer
			Reserved	Reserved	Reserved	Reserved	Reserved	Reserved	Reserved	Reserved	Reserved	Reserved	Reserved	Reserved	Reserved	Reserved	Trans Out 1 <sup>(2)</sup>	Trans Out 0 <sup>(1)</sup>	Relay Out 0																																									
		Default	0	0	0	0	0	0	0	0	0	0	0	0	0	0	0	0	0																																									
		Bit	15	14	13	12	11	10	9	8	7	6	5	4	3	2	1	0																																										
7	<b>Dig Out Setpoint</b> Digital Output Setpoint Controls Relay or Transistor Outputs when chosen as the source. Can be used to control outputs from a communication device using DataLinks.  Options <table border="1"> <tr> <td></td> <td>Reserved</td><td>Reserved</td><td>Reserved</td><td>Reserved</td><td>Reserved</td><td>Reserved</td><td>Reserved</td><td>Reserved</td><td>Reserved</td><td>Reserved</td><td>Reserved</td><td>Reserved</td><td>Reserved</td><td>Trans Out 1<sup>(2)</sup></td><td>Trans Out 0<sup>(1)</sup></td><td>Relay Out 0</td> </tr> <tr> <td>Default</td> <td>0</td><td>0</td><td>0</td><td>0</td><td>0</td><td>0</td><td>0</td><td>0</td><td>0</td><td>0</td><td>0</td><td>0</td><td>0</td><td>0</td><td>0</td><td>0</td> </tr> <tr> <td>Bit</td> <td>15</td><td>14</td><td>13</td><td>12</td><td>11</td><td>10</td><td>9</td><td>8</td><td>7</td><td>6</td><td>5</td><td>4</td><td>3</td><td>2</td><td>1</td><td>0</td> </tr> </table> 0 = Output De-energized 1 = Output Energized  (1) Bit 1 = "Trans Out 0" for 22-Series I/O Module model 20-750-2263C-1R2T = "Relay Out 1" for 22-Series I/O Module models 20-750-2262C-2R and 20-750-2262D-2R (2) Bit 2 is only used by 22-Series I/O Module 20-750-2263C-1R2T		Reserved	Reserved	Reserved	Reserved	Reserved	Reserved	Reserved	Reserved	Reserved	Reserved	Reserved	Reserved	Reserved	Trans Out 1 <sup>(2)</sup>	Trans Out 0 <sup>(1)</sup>	Relay Out 0	Default	0	0	0	0	0	0	0	0	0	0	0	0	0	0	0	0	Bit	15	14	13	12	11	10	9	8	7	6	5	4	3	2	1	0		RW	16-bit Integer					
	Reserved	Reserved	Reserved	Reserved	Reserved	Reserved	Reserved	Reserved	Reserved	Reserved	Reserved	Reserved	Reserved	Trans Out 1 <sup>(2)</sup>	Trans Out 0 <sup>(1)</sup>	Relay Out 0																																												
Default	0	0	0	0	0	0	0	0	0	0	0	0	0	0	0	0																																												
Bit	15	14	13	12	11	10	9	8	7	6	5	4	3	2	1	0																																												
10	<b>R00 Sel</b> Relay Output 0 Select Selects the source that will energize the relay output. Any status parameter bit can be used as an output source. For example P935 [Drive Status 1] Bit 7 "Faulted." For Torque Proving set to Port 0, parameter 1103 Bit 4. Use N.O. for safety.	Default: 0.00 (Disabled) Min/Max: 0.00 / 159999.15	RW	32-bit Integer																																																								
11	<b>R00 Level Sel</b> Relay Output 0 Level Select Selects the source of the level that will be compared.	Default: 0 (Disabled) Min/Max: 0 / 159999	RW	32-bit Integer																																																								
12	<b>R00 Level</b> Relay Output 0 Level Sets the level compare value.	Default: 0.0 Min/Max: -/+1000000.0	RW	Real																																																								
13	<b>R00 Level CmpSts</b> Relay Output 0 Level Compare Status  Status of the level compare, and a possible source for a relay or transistor output. Relay Output <i>n</i> Select or Transistor Output <i>n</i> Select must have this selected to energize the output. Can be used without a physical output as status information only.  Options <table border="1"> <tr> <td></td> <td>Reserved</td><td>Reserved</td><td>Reserved</td><td>Reserved</td><td>Reserved</td><td>Reserved</td><td>Reserved</td><td>Reserved</td><td>Reserved</td><td>Reserved</td><td>Reserved</td><td>Reserved</td><td>AbsGrtThanEq</td><td>Abs Less Than</td><td>Grt Than Equ</td><td>Less Than</td> </tr> <tr> <td>Default</td> <td>0</td><td>0</td><td>0</td><td>0</td><td>0</td><td>0</td><td>0</td><td>0</td><td>0</td><td>0</td><td>0</td><td>0</td><td>0</td><td>0</td><td>0</td><td>0</td> </tr> <tr> <td>Bit</td> <td>15</td><td>14</td><td>13</td><td>12</td><td>11</td><td>10</td><td>9</td><td>8</td><td>7</td><td>6</td><td>5</td><td>4</td><td>3</td><td>2</td><td>1</td><td>0</td> </tr> </table> 0 = Condition False 1 = Condition True  Bit 0 "Less Than" – Level source is less than the level value. Bit 1 "Grt Than Equ" – Level source is greater than or equal to the level value. Bit 2 "Abs Less Than" – Absolute value of the level source is less than the absolute value of the level value. Bit 3 "AbsGrtThanEq" – Absolute value of the level source is greater than or equal to the absolute value of the level value.		Reserved	Reserved	Reserved	Reserved	Reserved	Reserved	Reserved	Reserved	Reserved	Reserved	Reserved	Reserved	AbsGrtThanEq	Abs Less Than	Grt Than Equ	Less Than	Default	0	0	0	0	0	0	0	0	0	0	0	0	0	0	0	0	Bit	15	14	13	12	11	10	9	8	7	6	5	4	3	2	1	0		RO	16-bit Integer					
	Reserved	Reserved	Reserved	Reserved	Reserved	Reserved	Reserved	Reserved	Reserved	Reserved	Reserved	Reserved	AbsGrtThanEq	Abs Less Than	Grt Than Equ	Less Than																																												
Default	0	0	0	0	0	0	0	0	0	0	0	0	0	0	0	0																																												
Bit	15	14	13	12	11	10	9	8	7	6	5	4	3	2	1	0																																												

File	Group	No.	Display Name Full Name Description	Values	Read-Write	Data Type																																																			
22-Series I/O	Digital Outputs	14	<b>R00 On Time</b> Relay Output 0 On Time Sets the "ON Delay" time for the digital outputs. This is the time between the occurrence of a condition and activation of the relay.	Units: Secs Default: 0.0 Min/Max: 0.0 / 600.0	RW	Real																																																			
		15	<b>R00 Off Time</b> Relay Output 0 Off Time Sets the "OFF Delay" time for the digital outputs. This is the time between the disappearance of a condition and de-activation of the relay.	Units: Secs Default: 0.0 Min/Max: 0.0 / 600.0	RW	Real																																																			
		20	<b>R01 Sel</b> Relay Output 1 Select – 22-Series I/O Module model 20-750-2262C-2R or 20-750-2262D-2R is installed. <b>T00 Sel</b> Transistor Output 0 Select – 22-Series I/O Module model 20-750-2263C-1R2T is installed. Selects the source that will energize the relay or transistor output. Any status parameter bit can be used as an output source. For example P935 [Drive Status 1] Bit 7 "Faulted."	Default: 0.00 (Disabled) Min/Max: 0.00 / 159999.15	RW	32-bit Integer																																																			
		21	<b>R01 Level Sel</b> Relay Output 1 Level Select – 22-Series I/O Module model 20-750-2262C-2R or 20-750-2262D-2R is installed. <b>T00 Level Sel</b> Transistor Output 0 Level Select – 22-Series I/O Module model 20-750-2263C-1R2T is installed. Selects the source of the level that will be compared.	Default: 0 (Disabled) Min/Max: 0 / 159999	RW	32-bit Integer																																																			
		22	<b>R01 Level</b> Relay Output 1 Level – 22-Series I/O Module model 20-750-2262C-2R or 20-750-2262D-2R is installed. <b>T00 Level</b> Transistor Output 0 Level – 22-Series I/O Module model 20-750-2263C-1R2T is installed. Sets the level compare value.	Default: 0.0 Min/Max: -/+1000000.0	RW	Real																																																			
		23	<b>R01 Level CmpSts</b> Relay Output 1 Level Compare Status – 22-Series I/O Module model 20-750-2262C-2R or 20-750-2262D-2R is installed. <b>T00 Level CmpSts</b> Transistor Output 0 Level Compare Status – 22-Series I/O Module model 20-750-2263C-1R2T is installed. Status of the level compare, and a possible source for a relay or transistor output. Relay Output <i>n</i> Select or Transistor Output <i>n</i> Select must have this selected to energize the output. Can be used without a physical output as status information only.  Options <table border="1" style="margin-left: 20px;"> <tr> <td></td> <td>Reserved</td><td>Reserved</td><td>Reserved</td><td>Reserved</td><td>Reserved</td><td>Reserved</td><td>Reserved</td><td>Reserved</td><td>Reserved</td><td>Reserved</td><td>Reserved</td><td>Reserved</td><td>AbsGrtThanEq</td><td>Abs Less Than</td><td>Grt Than Equ</td><td>Less Than</td> </tr> <tr> <td>Default</td> <td>0</td><td>0</td><td>0</td><td>0</td><td>0</td><td>0</td><td>0</td><td>0</td><td>0</td><td>0</td><td>0</td><td>0</td><td>0</td><td>0</td><td>0</td><td>0</td> </tr> <tr> <td>Bit</td> <td>15</td><td>14</td><td>13</td><td>12</td><td>11</td><td>10</td><td>9</td><td>8</td><td>7</td><td>6</td><td>5</td><td>4</td><td>3</td><td>2</td><td>1</td><td>0</td> </tr> </table> 0 = Condition False 1 = Condition True  Bit 0 "Less Than" – Level source is less than the level value. Bit 1 "Grt Than Equ" – Level source is greater than or equal to the level value. Bit 2 "Abs Less Than" – Absolute value of the level source is less than the absolute value of the level value. Bit 3 "AbsGrtThanEq" – Absolute value of the level source is greater than or equal to the absolute value of the level value.		Reserved	Reserved	Reserved	Reserved	Reserved	Reserved	Reserved	Reserved	Reserved	Reserved	Reserved	Reserved	AbsGrtThanEq	Abs Less Than	Grt Than Equ	Less Than	Default	0	0	0	0	0	0	0	0	0	0	0	0	0	0	0	0	Bit	15	14	13	12	11	10	9	8	7	6	5	4	3	2	1	0		RO	16-bit Integer
			Reserved	Reserved	Reserved	Reserved	Reserved	Reserved	Reserved	Reserved	Reserved	Reserved	Reserved	Reserved	AbsGrtThanEq	Abs Less Than	Grt Than Equ	Less Than																																							
		Default	0	0	0	0	0	0	0	0	0	0	0	0	0	0	0	0																																							
Bit	15	14	13	12	11	10	9	8	7	6	5	4	3	2	1	0																																									
24	<b>R01 On Time</b> Relay Output 1 On Time – 22-Series I/O Module model 20-750-2262C-2R or 20-750-2262D-2R is installed. <b>T00 On Time</b> Transistor Output 0 On Time – 22-Series I/O Module model 20-750-2263C-1R2T is installed. Sets the "ON Delay" time for the digital outputs. This is the time between the occurrence of a condition and activation of the relay or transistor.	Units: Secs Default: 0.0 Min/Max: 0.0 / 600.0	RW	Real																																																					



File	Group	No.	Display Name Full Name Description	Values	Read-Write	Data Type																																																	
22-Series I/O	Digital Outputs	25	<b>R01 Off Time</b> Relay Output 1 Off Time – 22-Series I/O Module model 20-750-2262C-2R or 20-750-2262D-2R is installed. <b>T00 Off Time</b> Transistor Output 0 Off Time – 22-Series I/O Module model 20-750-2263C-1R2T is installed. Sets the “OFF Delay” time for the digital outputs. This is the time between the disappearance of a condition and de-activation of the relay or transistor.	Units: Secs Default: 0.0 Min/Max: 0.0 / 600.0	RW	Real																																																	
		30	<b>T01 Sel</b> Transistor Output 1 Select Selects the source that will energize the transistor output. Any status parameter bit can be used as an output source. For example P935 [Drive Status 1] Bit 7 “Faulted.” <b>Important:</b> Only used by 22-Series I/O Module model 20-750-2263C-1R2T.	Default: 0 (Disabled) Min/Max: 0 / 159999.15	RW	32-bit Integer																																																	
		31	<b>T01 Level Sel</b> Transistor Output 1 Level Select Selects the source of the level that will be compared. <b>Important:</b> Only used by 22-Series I/O Module model 20-750-2263C-1R2T.	Default: 0 (Disabled) Min/Max: 0 / 159999.15	RW	32-bit Integer																																																	
		32	<b>T01 Level</b> Transistor Output 1 Level Sets the level compare value. <b>Important:</b> Only used by 22-Series I/O Module model 20-750-2263C-1R2T.	Default: 0.0 Min/Max: -/+1000000.0	RW	Real																																																	
		33	<b>T01 Level CmpSts</b> Transistor Output 1 Level Compare Status Status of the level compare, and a possible source for a transistor output. Transistor Output <i>n</i> Select must have this selected to energize the output. Can be used without a physical output as status information only.  Options <table border="1" style="display: inline-table; vertical-align: top;"> <tr> <td></td> <td>Reserved</td> <td>Reserved</td> <td>Reserved</td> <td>Reserved</td> <td>Reserved</td> <td>Reserved</td> <td>Reserved</td> <td>Reserved</td> <td>Reserved</td> <td>Reserved</td> <td>Reserved</td> <td>AbsGrtThanEq</td> <td>Abs Less Than</td> <td>Grt Than Equ</td> <td>Less Than</td> </tr> <tr> <td>Default</td> <td>0</td> <td>0</td> <td>0</td> <td>0</td> <td>0</td> <td>0</td> <td>0</td> <td>0</td> <td>0</td> <td>0</td> <td>0</td> <td>0</td> <td>0</td> <td>0</td> <td>0</td> </tr> <tr> <td>Bit</td> <td>15</td> <td>14</td> <td>13</td> <td>12</td> <td>11</td> <td>10</td> <td>9</td> <td>8</td> <td>7</td> <td>6</td> <td>5</td> <td>4</td> <td>3</td> <td>2</td> <td>1</td> <td>0</td> </tr> </table> 0 = Condition False 1 = Condition True  Bit 0 “Less Than” – Level source is less than the level value. Bit 1 “Grt Than Equ” – Level source is greater than or equal to the level value. Bit 2 “Abs Less Than” – Absolute value of the level source is less than the absolute value of the level value. Bit 3 “AbsGrtThanEq” – Absolute value of the level source is greater than or equal to the absolute value of the level value. <b>Important:</b> Only used by 22-Series I/O Module model 20-750-2263C-1R2T.		Reserved	Reserved	Reserved	Reserved	Reserved	Reserved	Reserved	Reserved	Reserved	Reserved	Reserved	AbsGrtThanEq	Abs Less Than	Grt Than Equ	Less Than	Default	0	0	0	0	0	0	0	0	0	0	0	0	0	0	0	Bit	15	14	13	12	11	10	9	8	7	6	5	4	3	2	1	0		RO	16-bit Integer
			Reserved	Reserved	Reserved	Reserved	Reserved	Reserved	Reserved	Reserved	Reserved	Reserved	Reserved	AbsGrtThanEq	Abs Less Than	Grt Than Equ	Less Than																																						
Default	0	0	0	0	0	0	0	0	0	0	0	0	0	0	0																																								
Bit	15	14	13	12	11	10	9	8	7	6	5	4	3	2	1	0																																							
34	<b>T01 On Time</b> Transistor Output 1 On Time Sets the “ON Delay” time for the digital outputs. This is the time between the occurrence of a condition and activation of the transistor. <b>Important:</b> Only used by 22-Series I/O Module model 20-750-2263C-1R2T.	Units: Secs Default: 0.0 Min/Max: 0.0 / 600.0	RW	Real																																																			
35	<b>T01 Off Time</b> Transistor Output 1 Off Time Sets the “OFF Delay” time for the digital outputs. This is the time between the disappearance of a condition and de-activation of the transistor. <b>Important:</b> Only used by 22-Series I/O Module model 20-750-2263C-1R2T.	Units: Secs Default: 0.0 Min/Max: 0.0 / 600.0	RW	Real																																																			

File	Group	No.	Display Name Full Name Description	Values	Read-Write	Data Type
22-Series I/O	Motor PTC	40	<b>PTC Cfg</b> Positive Temperature Coefficient Configuration Sets the action that will be taken when the PTC is not Ok. "Ignore" (0) – No action is taken. "Alarm" (1) – Type 1 alarm indicated. "Flt Minor" (2) – Minor fault indicated. If running, drive continues to run. Enable with P950 [Minor Flt Cfg]. If not enabled, acts like a major fault. "FltCoastStop" (3) – Major fault indicated. Coast to Stop. "Flt RampStop" (4) – Major fault indicated. Ramp to Stop. "Flt CL Stop" (5) – Major fault indicated. Current Limit Stop.	Default: 0 = "Ignore" Options: 0 = "Ignore" 1 = "Alarm" 2 = "Flt Minor" 3 = "FltCoastStop" 4 = "Flt RampStop" 5 = "Flt CL Stop"	RW	32-bit Integer
		41	<b>PTC Sts</b> Positive Temperature Coefficient Status Status of the PTC.  Options Reserved Reserved Reserved Reserved Reserved Reserved Reserved Reserved Reserved Reserved Reserved Reserved Reserved Reserved Over Temp PTC Short PTC Ok Default 0 0 0 0 0 0 0 0 0 0 0 0 0 0 0 0 0 Bit 15 14 13 12 11 10 9 8 7 6 5 4 3 2 1 0  Bit 0 "PTC Ok" – PTC is OK Bit 1 "PTC Short" – PTC is Shorted Bit 2 "Over Temp" – PTC is indicating over temperature	0 = Condition False 1 = Condition True	RO	16-bit Integer
		42	<b>PTC Raw Value</b> Positive Temperature Coefficient Raw Value Displays the value of the PTC.	Units: Volt Default: 0 Min/Max: 0 / 10	RO	Real

File	Group	No.	Display Name Full Name Description	Values	Read-Write	Data Type
22-Series I/O	Analog Inputs	45	<b>Anlg In Type</b> Analog Input Type Status of the analog input mode set by the option jumpers.  Options Reserved Reserved Reserved Reserved Reserved Reserved Reserved Reserved Reserved Reserved Reserved Reserved Reserved Reserved Analog 1 Analog 0 Default 0 0 0 0 0 0 0 0 0 0 0 0 0 0 0 0 Bit 15 14 13 12 11 10 9 8 7 6 5 4 3 2 1 0	0 = Voltage Mode 1 = Current Mode	RO	16-bit Integer
		46	<b>Anlg In Sqrt</b> Analog Input Square Root Enables/disables the square root function for each input.  Options Reserved Reserved Reserved Reserved Reserved Reserved Reserved Reserved Reserved Reserved Reserved Reserved Reserved Reserved Analog 1 Analog 0 Default 0 0 0 0 0 0 0 0 0 0 0 0 0 0 0 0 Bit 15 14 13 12 11 10 9 8 7 6 5 4 3 2 1 0	0 = Square Root Disabled 1 = Square Root Enabled	RW	16-bit Integer

File	Group	No.	Display Name Full Name Description	Values	Read-Write	Data Type
22-Series I/O	Analog Inputs	47	<b>Anlg In Loss Sts</b> Analog Input Loss Status Status of the analog input loss.  Options Reserved Reserved Reserved Reserved Reserved Reserved Reserved Reserved Reserved Reserved Reserved Reserved Reserved Loss 1 Loss 0 Loss Default 0 0 0 0 0 0 0 0 0 0 0 0 0 0 0 0 0 Bit 15 14 13 12 11 10 9 8 7 6 5 4 3 2 1 0  0 = No Loss 1 = Loss Detected  Bit 0 "Loss" – Indicates loss of one or both inputs.		RO	16-bit Integer
		50	<b>Anlg In0 Value</b> Analog Input 0 Value Value of the Analog input after filter, square root, and loss action.	Units: Volt mA Default: 0.000 Volts 0.000 mA Min/Max: -/+10.000 Volts 0.000 / 20.000 mA	RO	Real
		51	<b>Anlg In0 Hi</b> Analog Input 0 High Sets the highest input value to the analog input scaling block.	Units: Volt mA Default: 0.000 Volts 0.000 mA Min/Max: -/+10.000 Volts 0.000 / 20.000 mA	RW	Real
		52	<b>Anlg In0 Lo</b> Analog Input 0 Low Sets the lowest input value to the analog input scaling block.	Units: Volt mA Default: 0.000 Volts 0.000 mA Min/Max: -/+10.000 Volts 0.000 / 20.000 mA	RW	Real
		53	<b>Anlg In0 LssActn</b> Analog Input 0 Loss Action Selects drive action when an analog signal loss is detected. Signal loss is defined as an analog signal less than 1V or 2mA. The signal loss event ends and normal operation resumes when the input signal level is greater than or equal to 1.5V or 3mA. "Ignore" (0) – No action is taken. "Alarm" (1) – Type 1 alarm indicated. "Flt Minor" (2) – Minor fault indicated. If running, drive continues to run. Enable with P950 [Minor Flt Cfg]. If not enabled, acts like a major fault. "FltCoastStop" (3) – Major fault indicated. Coast to Stop. "Flt RampStop" (4) – Major fault indicated. Ramp to Stop. "Flt CL Stop" (5) – Major fault indicated. Current Limit Stop. "Hold Input" (6) – Holds input at last value. "Set Input Lo" (7) – Sets input to P52 [Anlg In0 Lo]. "Set Input Hi" (8) – Sets input to P51 [Anlg In0 Hi].	Default: 0 = "Ignore" Options: 0 = "Ignore" 1 = "Alarm" 2 = "Flt Minor" 3 = "FltCoastStop" 4 = "Flt RampStop" 5 = "Flt CL Stop" 6 = "Hold Input" 7 = "Set Input Lo" 8 = "Set Input Hi"	RW	32-bit Integer
		54	<b>Anlg In0 Raw Val</b> Analog Input 0 Raw Value Raw Value of the analog input.	Units: Volt mA Default: 0.000 Volts 0.000 mA Min/Max: -/+10.000 Volts 0.000 / 20.000 mA	RO	Real
		55	<b>Anlg In0 Filt Gn</b> Analog Input 0 Filter Gain Sets the analog input filter gain.	Default: 1.00 Min/Max: -/+5.00	RW	Real

File	Group	No.	Display Name Full Name Description	Values		Read-Write	Data Type
22-Series I/O	Analog Inputs	56	<b>Anlg In0 Filt BW</b> Analog Input 0 Filter Bandwidth Sets the analog input filter bandwidth.	Default: 0.0 Min/Max: 0.0 / 500.0		RW	Real
		60	<b>Anlg In1 Value</b> Analog Input 1 Value Value of the Analog input after filter, square root, and loss action.	Units: Volt mA Default: 0.000 Volts 0.000 mA Min/Max: -/+10.000 Volts 0.000 / 20.000 mA		RO	Real
		61	<b>Anlg In1 Hi</b> Analog Input 1 High Sets the highest input value to the analog input scaling block.	Units: Volt mA Default: 10.000 Volts 20.000 mA Min/Max: -/+10.000 Volts 0.000 / 20.000 mA		RW	Real
		62	<b>Anlg In1 Lo</b> Analog Input 1 Low Sets the lowest input value to the analog input scaling block.	Units: Volt mA Default: 0.000 Volts 0.000 mA Min/Max: -/+10.000 Volts 0.000 / 20.000 mA		RW	Real
		63	<b>Anlg In1 LssActn</b> Analog Input 1 Loss Action Selects drive action when an analog signal loss is detected. Signal loss is defined as an analog signal less than 1V or 2mA. The signal loss event ends and normal operation resumes when the input signal level is greater than or equal to 1.5V or 3mA. "Ignore" (0) – No action is taken. "Alarm" (1) – Type 1 alarm indicated. "Flt Minor" (2) – Minor fault indicated. If running, drive continues to run. Enable with P950 [Minor Flt Cfg]. If not enabled, acts like a major fault. "FltCoastStop" (3) – Major fault indicated. Coast to Stop. "Flt RampStop" (4) – Major fault indicated. Ramp to Stop. "Flt CL Stop" (5) – Major fault indicated. Current Limit Stop. "Hold Input" (6) – Holds input at last value. "Set Input Lo" (7) – Sets input to P62 [Anlg In1 Lo]. "Set Input Hi" (8) – Sets input to P61 [Anlg In1 Hi].	Default: 0 = "Ignore" Options: 0 = "Ignore" 1 = "Alarm" 2 = "Flt Minor" 3 = "FltCoastStop" 4 = "Flt RampStop" 5 = "Flt CL Stop" 6 = "Hold Input" 7 = "Set Input Lo" 8 = "Set Input Hi"		RW	32-bit Integer
		64	<b>Anlg In1 Raw Val</b> Analog Input 1 Raw Value Raw Value of the analog input.	Units: Volt mA Default: 0.000 Volts 0.000 mA Min/Max: -/+10.000 Volts 0.000 / 20.000 mA		RO	Real
		65	<b>Anlg In1 Filt Gn</b> Analog Input 1 Filter Gain Sets the analog input filter gain.	Default: 1.00 Min/Max: -/+5.00		RW	Real
		66	<b>Anlg In1 Filt BW</b> Analog Input 1 Filter Bandwidth Sets the analog input filter bandwidth.	Default: 0.0 Min/Max: 0.0 / 500.0		RW	Real

File	Group	No.	Display Name Full Name Description	Values	Read-Write	Data Type																																																						
22-Series I/O	Analog Outputs	70	<b>Anlg Out Type</b> Analog Output Type Select the analog output mode for each analog output.  Options <table border="1"> <tr> <td></td> <td>Reserved</td><td>Reserved</td><td>Reserved</td><td>Reserved</td><td>Reserved</td><td>Reserved</td><td>Reserved</td><td>Reserved</td><td>Reserved</td><td>Reserved</td><td>Reserved</td><td>Reserved</td><td>Reserved</td><td>Reserved</td><td>Reserved</td><td>Analog 1</td><td>Analog 0</td> </tr> <tr> <td>Default</td> <td>0</td><td>0</td><td>0</td><td>0</td><td>0</td><td>0</td><td>0</td><td>0</td><td>0</td><td>0</td><td>0</td><td>0</td><td>0</td><td>0</td><td>0</td><td>0</td><td>0</td> </tr> <tr> <td>Bit</td> <td>15</td><td>14</td><td>13</td><td>12</td><td>11</td><td>10</td><td>9</td><td>8</td><td>7</td><td>6</td><td>5</td><td>4</td><td>3</td><td>2</td><td>1</td><td>0</td><td>0</td> </tr> </table>		Reserved	Reserved	Reserved	Reserved	Reserved	Reserved	Reserved	Reserved	Reserved	Reserved	Reserved	Reserved	Reserved	Reserved	Reserved	Analog 1	Analog 0	Default	0	0	0	0	0	0	0	0	0	0	0	0	0	0	0	0	0	Bit	15	14	13	12	11	10	9	8	7	6	5	4	3	2	1	0	0	0 = Voltage Mode 1 = Current Mode	RW	16-bit Integer
			Reserved	Reserved	Reserved	Reserved	Reserved	Reserved	Reserved	Reserved	Reserved	Reserved	Reserved	Reserved	Reserved	Reserved	Reserved	Analog 1	Analog 0																																									
		Default	0	0	0	0	0	0	0	0	0	0	0	0	0	0	0	0	0																																									
		Bit	15	14	13	12	11	10	9	8	7	6	5	4	3	2	1	0	0																																									
		71	<b>Anlg Out Abs</b> Analog Output Absolute Selects whether the signed value or absolute value of a parameter is used before being scaled to drive the analog output.  Options <table border="1"> <tr> <td></td> <td>Reserved</td><td>Reserved</td><td>Reserved</td><td>Reserved</td><td>Reserved</td><td>Reserved</td><td>Reserved</td><td>Reserved</td><td>Reserved</td><td>Reserved</td><td>Reserved</td><td>Reserved</td><td>Reserved</td><td>Reserved</td><td>Reserved</td><td>Analog 1</td><td>Analog 0</td> </tr> <tr> <td>Default</td> <td>0</td><td>0</td><td>0</td><td>0</td><td>0</td><td>0</td><td>0</td><td>0</td><td>0</td><td>0</td><td>0</td><td>0</td><td>0</td><td>0</td><td>0</td><td>1</td><td>1</td> </tr> <tr> <td>Bit</td> <td>15</td><td>14</td><td>13</td><td>12</td><td>11</td><td>10</td><td>9</td><td>8</td><td>7</td><td>6</td><td>5</td><td>4</td><td>3</td><td>2</td><td>1</td><td>0</td><td>0</td> </tr> </table>		Reserved	Reserved	Reserved	Reserved	Reserved	Reserved	Reserved	Reserved	Reserved	Reserved	Reserved	Reserved	Reserved	Reserved	Reserved	Analog 1	Analog 0	Default	0	0	0	0	0	0	0	0	0	0	0	0	0	0	0	1	1	Bit	15	14	13	12	11	10	9	8	7	6	5	4	3	2	1	0	0	0 = Condition False 1 = Condition True	RW	16-bit Integer
			Reserved	Reserved	Reserved	Reserved	Reserved	Reserved	Reserved	Reserved	Reserved	Reserved	Reserved	Reserved	Reserved	Reserved	Reserved	Analog 1	Analog 0																																									
		Default	0	0	0	0	0	0	0	0	0	0	0	0	0	0	0	1	1																																									
		Bit	15	14	13	12	11	10	9	8	7	6	5	4	3	2	1	0	0																																									
		75	<b>Anlg Out0 Sel</b> Analog Output 0 Select Selects the source for the analog output.	Default: 3 Min/Max: 0 / 159999	RW	32-bit Integer																																																						
76	<b>Anlg Out0 Stpt</b> Analog Output 0 Setpoint A possible source for an analog output. Can be used to control an analog output from a communication device using a DataLink. Not affected by analog output scaling.	Units: Volt mA Default: 10.000 Volts 20.000 mA Min/Max: -/+10.000 Volts 0.000 / 20.000 mA	RW	Real																																																								
77	<b>Anlg Out0 Data</b> Analog Output 0 Data Displays the value of the source selected by P75 [Anlg Out0 Sel].	Default: 0 Min/Max: -/+40000.000	RO	Real																																																								
78	<b>Anlg Out0 DataHi</b> Analog Output 0 Data High Sets the high value for the data range of analog out scale.	Units: pu Default: 1 Min/Max: -/+40000.000	RW	Real																																																								
79	<b>Anlg Out0 DataLo</b> Analog Output 0 Data Low Sets the low value for the data range of analog out scale.	Default: 1 Min/Max: -/+40000.000	RW	Real																																																								
80	<b>Anlg Out0 Hi</b> Analog Output 0 High Sets the high value for the analog output value when the data value is at its maximum.	Units: Volt mA Default: 10.000 Volts 20.000 mA Min/Max: -/+10.000 Volts 0.000 / 20.000 mA	RW	Real																																																								
81	<b>Anlg Out0 Lo</b> Analog Output 0 Low Sets the low value for the analog output value when the data value is at its minimum.	Units: Volt mA Default: 0.000 Volts 0.000 mA Min/Max: -/+10.000 Volts 0.000 / 20.000 mA	RW	Real																																																								




File	Group	No.	Display Name Full Name Description	Values		Read-Write	Data Type
22-Series I/O	Analog Outputs	82	<b>Anlg Out0 Val</b> Analog Output 0 Value Displays the analog output value.	Units: Volt mA Default: 10.000 Volts 20.000 mA Min/Max: -/+10.000 Volts 0.000 / 20.000 mA		RO	Real
		85	<b>Anlg Out1 Sel</b> Analog Output 1 Select Selects the source for the analog output.	Default: 7 Min/Max: 0 / 159999		RW	32-bit Integer
		86	<b>Anlg Out1 Stpt</b> Analog Output 1 Setpoint A possible source for an analog output. Can be used to control an analog output from a communication device using a DataLink. Not affected by analog output scaling.	Units: Volt mA Default: 0.000 Volts 0.000 mA Min/Max: -/+10.000 Volts 0.000 / 20.000 mA		RW	Real
		87	<b>Anlg Out1 Data</b> Analog Output 1 Data Displays the value of the source selected by P85 [Anlg Out1 Sel].	Default: 0.000 Min/Max: 0.000 / 4140.00		RO	Real
		88	<b>Anlg Out1 DataHi</b> Analog Output 1 Data High Sets the high value for the data range of analog out scale.	Default: 1.000 Min/Max: 0.000 / 4140.00		RW	Real
		89	<b>Anlg Out1 DataLo</b> Analog Output 1 Data Low Sets the low value for the data range of analog out scale.	Default: 0.000 Min/Max: 0.000 / 4140.00		RW	Real
		90	<b>Anlg Out1 Hi</b> Analog Output 1 High Sets the high value for the analog output value when the data value is at its maximum.	Units: Volt mA Default: 10.000 Volts 20.000 mA Min/Max: -/+10.000 Volts 0.000 / 20.000 mA		RW	Real
		91	<b>Anlg Out1 Lo</b> Analog Output 1 Low Sets the low value for the analog output value when the data value is at its minimum.	Units: Volt mA Default: 0.000 Volts 0.000 mA Min/Max: -/+10.000 Volts 0.000 / 20.000 mA		RW	Real
		92	<b>Anlg Out1 Val</b> Analog Output 1 Value Displays the analog output value.	Units: Volt mA Default: 0.000 Volts 0.000 mA Min/Max: -/+10.000 Volts 0.000 / 20.000 mA		RO	Real

File	Group	No.	Display Name Full Name Description	Values	Read-Write	Data Type																																																	
22-Series I/O	Predictive Main	99	<b>PredMaint Sts</b> Predictive Maintenance Status Status of relay's predictive maintenance.  Options <table border="1" style="display: inline-table; vertical-align: top;"> <tr> <td></td> <td>Master</td> <td>Reserved</td> <td>Reserved</td> <td>Reserved</td> <td>Reserved</td> <td>Reserved</td> <td>Reserved</td> <td>Reserved</td> <td>Reserved</td> <td>Reserved</td> <td>Reserved</td> <td>Reserved</td> <td>Reserved</td> <td>Relay Out 0<sup>(1)</sup></td> <td>Relay Out 0</td> </tr> <tr> <td>Default</td> <td>0</td> <td>0</td> <td>0</td> <td>0</td> <td>0</td> <td>0</td> <td>0</td> <td>0</td> <td>0</td> <td>0</td> <td>0</td> <td>0</td> <td>0</td> <td>0</td> <td>0</td> </tr> <tr> <td>Bit</td> <td>15</td> <td>14</td> <td>13</td> <td>12</td> <td>11</td> <td>10</td> <td>9</td> <td>8</td> <td>7</td> <td>6</td> <td>5</td> <td>4</td> <td>3</td> <td>2</td> <td>1</td> <td>0</td> </tr> </table>		Master	Reserved	Reserved	Reserved	Reserved	Reserved	Reserved	Reserved	Reserved	Reserved	Reserved	Reserved	Reserved	Relay Out 0 <sup>(1)</sup>	Relay Out 0	Default	0	0	0	0	0	0	0	0	0	0	0	0	0	0	0	Bit	15	14	13	12	11	10	9	8	7	6	5	4	3	2	1	0	0 = Condition False 1 = Condition True	RO	16-bit Integer
			Master	Reserved	Reserved	Reserved	Reserved	Reserved	Reserved	Reserved	Reserved	Reserved	Reserved	Reserved	Reserved	Relay Out 0 <sup>(1)</sup>	Relay Out 0																																						
		Default	0	0	0	0	0	0	0	0	0	0	0	0	0	0	0																																						
		Bit	15	14	13	12	11	10	9	8	7	6	5	4	3	2	1	0																																					
		100	<b>R00 Load Type</b> Relay Output 0 Load Type Sets the type of load that will be applied to the relay. Must be properly set for the Predictive Maintenance function to predict the relay life.	Default: 1 = "DC Inductive" Options: 0 = "DC Resistive" 1 = "DC Inductive" 2 = "AC Resistive" 3 = "AC Inductive"	RW	32-bit Integer																																																	
		101	<b>R00 Load Amps</b> Relay Output 0 Load Amps Load current that will be applied to the relay contacts. Must be properly set for the Predictive Maintenance function to approximate the relay life.	Units: Amps Default: 2.000 Min/Max: 0.000 / 2.000	RW	Real																																																	
		102	<b>R00 TotalLife</b> Relay Output 0 Total Life Total life cycles of the relay based on programmed load type and amps.	Units: Cycl Default: 0 Min/Max: 0 / 2147483647	RO	32-bit Integer																																																	
		103	<b>R00 ElapsedLife</b> Relay Output 0 Elapsed Life Non-resettable, total accumulated cycles of the relay.	Units: Cycl Default: 0 Min/Max: 0 / 2147483647	RO	32-bit Integer																																																	
104	<b>R00 RemainLife</b> Relay Output 0 Remaining Life The difference between the Total Life and the Elapsed Life.	Units: Cycl Default: 0 Min/Max: -/+2147483647	RO	32-bit Integer																																																			
105	<b>R00 LifeEvtLvl</b> Relay Output 0 Life Event Level Sets the percentage of relay life cycles before action is taken.	Units: % Default: 80.000 Min/Max: 0.000 / 100.000	RW	Real																																																			
106	<b>R00 LifeEvtActn</b> Relay Output 0 Life Event Action Sets the action that will be taken when the percentage of relay life cycles has been reached. "Ignore" (0) – No action is taken. "Alarm" (1) – Type 1 alarm indicated. "Flt Minor" (2) – Minor fault indicated. If running, drive continues to run. Enable with P950 [Minor Flt Cfg]. If not enabled, acts like a major fault. "FltCoastStop" (3) – Major fault indicated. Coast to Stop. "Flt RampStop" (4) – Major fault indicated. Ramp to Stop. "Flt CL Stop" (5) – Major fault indicated. Current Limit Stop.	Default: 1 = "Alarm" Options: 0 = "Ignore" 1 = "Alarm" 2 = "Flt Minor" 3 = "FltCoastStop" 4 = "Flt RampStop" 5 = "Flt CL Stop"	RW	32-bit Integer																																																			

File	Group	No.	Display Name Full Name Description	Values	Read-Write	Data Type
22-Series I/O	Predictive Main	110	<b>R01 Load Type</b> Relay Output 1 Load Type Sets the type of load that will be applied to the relay. Must be properly set for the Predictive Maintenance function to predict the relay life. <b>Important:</b> Only used by 22-Series I/O Module models 20-750-2262C-2R and 20-750-2262D-2R.	Default: 1 = "DC Inductive" Options: 0 = "DC Resistive" 1 = "DC Inductive" 2 = "AC Resistive" 3 = "AC Inductive"	RW	32-bit Integer
		111	<b>R01 Load Amps</b> Relay Output 1 Load Amps Load current that will be applied to the relay contacts. Must be properly set for the Predictive Maintenance function to approximate the relay life. <b>Important:</b> Only used by 22-Series I/O Module models 20-750-2262C-2R and 20-750-2262D-2R.	Units: Amps Default: 2.000 Min/Max: 0.000 / 2.000	RW	Real
		112	<b>R01 TotalLife</b> Relay Output 1 Total Life Total life cycles of the relay based on programmed load type and amps. <b>Important:</b> Only used by 22-Series I/O Module models 20-750-2262C-2R and 20-750-2262D-2R.	Units: Cycl Default: 0 Min/Max: 0 / 2147483647	RO	32-bit Integer
		113	<b>R01 ElapsedLife</b> Relay Output 1 Elapsed Life Non-resettable, total accumulated cycles of the relay. <b>Important:</b> Only used by 22-Series I/O Module models 20-750-2262C-2R and 20-750-2262D-2R.	Units: Cycl Default: 0 Min/Max: 0 / 2147483647	RO	32-bit Integer
		114	<b>R01 RemainLife</b> Relay Output 1 Remaining Life The difference between the Total Life and the Elapsed Life. <b>Important:</b> Only used by 22-Series I/O Module models 20-750-2262C-2R and 20-750-2262D-2R.	Units: Cycl Default: 0 Min/Max: -/+2147483647	RO	32-bit Integer
		115	<b>R01 LifeEvtLvl</b> Relay Output 1 Life Event Level Sets the percentage of relay life cycles before action is taken. <b>Important:</b> Only used by 22-Series I/O Module models 20-750-2262C-2R and 20-750-2262D-2R.	Units: % Default: 80.000 Min/Max: 0.000 / 100.000	RW	Real
		116	<b>R01 LifeEvtActn</b> Relay Output 1 Life Event Action Sets the action that will be taken when the percentage of relay life cycles has been reached. <b>Important:</b> Only used by 22-Series I/O Module models 20-750-2262C-2R and 20-750-2262D-2R. "Ignore" (0) – No action is taken. "Alarm" (1) – Type 1 alarm indicated. "Flt Minor" (2) – Minor fault indicated. If running, drive continues to run. Enable with P950 [Minor Flt Cfg]. If not enabled, acts like a major fault. "FltCoastStop" (3) – Major fault indicated. Coast to Stop. "Flt RampStop" (4) – Major fault indicated. Ramp to Stop. "Flt CL Stop" (5) – Major fault indicated. Current Limit Stop.	Default: 1 = "Alarm" Options: 0 = "Ignore" 1 = "Alarm" 2 = "Flt Minor" 3 = "FltCoastStop" 4 = "Flt RampStop" 5 = "Flt CL Stop"	RW	32-bit Integer






# Single Incremental Encoder Module Parameters

File	Group	No.	Display Name Full Name Description	Values	Read-Write	Data Type																																																			
Single Incremental Encoder		1	<b>Encoder Cfg</b>  Encoder Configure Configures the direction, speed calculation method, signal type and active encoder channels.  Options <table border="1" style="margin-left: 20px;"> <thead> <tr> <th></th> <th>Reserved</th> <th>Reserved</th> <th>Reserved</th> <th>Reserved</th> <th>Reserved</th> <th>Reserved</th> <th>Reserved</th> <th>Reserved</th> <th>Reserved</th> <th>Reserved</th> <th>Direction</th> <th>Single Ended</th> <th>Inv Home In</th> <th>Edge Mode</th> <th>A Chan Only</th> <th>Z Chan Enbl</th> </tr> </thead> <tbody> <tr> <td>Default</td> <td>0</td> <td>0</td> <td>0</td> <td>0</td> <td>0</td> <td>0</td> <td>0</td> <td>0</td> <td>0</td> <td>0</td> <td>0</td> <td>0</td> <td>0</td> <td>0</td> <td>0</td> <td>0</td> </tr> <tr> <td>Bit</td> <td>15</td> <td>14</td> <td>13</td> <td>12</td> <td>11</td> <td>10</td> <td>9</td> <td>8</td> <td>7</td> <td>6</td> <td>5</td> <td>4</td> <td>3</td> <td>2</td> <td>1</td> <td>0</td> </tr> </tbody> </table> 0 = Condition False 1 = Condition True  Bit 0 "Z Channel Enbl" – Configures the Channel Z to be used and monitored for Phase Loss. A value of 0 = the Z channel will be ignored. Must be set if the encoder marker pulse is used. Bit 1 "A Chan Only" – Configures the module to use only the A channel, and ignore the B channel. In this mode, direction cannot be determined, and the position counter will always count up. Bit 2 "Edge Mode" – Configure the module to use AB edge time data for speed calculation rather than accumulated count. Recommended for low speed operation. Bit 3 "Inv Home In" – Configures the home input to be inverted. 1 = inverted, 0 = not inverted Bit 4 "Single Ended" – Configure when the A Quad B encoder has single ended signals. In this mode, Phase Loss detection is disabled. 0 = Differential, 1 = Single Ended Bit 5 "Direction" – Inverts the feedback count up/down associated with a given rotation direction internally. 1 = invert, 0 = do not invert This bit is changed by the direction test in the Start-Up routine when encoder direction is determined to be incorrect and "Change Logic" is selected when prompted.		Reserved	Reserved	Reserved	Reserved	Reserved	Reserved	Reserved	Reserved	Reserved	Reserved	Direction	Single Ended	Inv Home In	Edge Mode	A Chan Only	Z Chan Enbl	Default	0	0	0	0	0	0	0	0	0	0	0	0	0	0	0	0	Bit	15	14	13	12	11	10	9	8	7	6	5	4	3	2	1	0		RW	16-bit Integer
			Reserved	Reserved	Reserved	Reserved	Reserved	Reserved	Reserved	Reserved	Reserved	Reserved	Direction	Single Ended	Inv Home In	Edge Mode	A Chan Only	Z Chan Enbl																																							
		Default	0	0	0	0	0	0	0	0	0	0	0	0	0	0	0	0																																							
		Bit	15	14	13	12	11	10	9	8	7	6	5	4	3	2	1	0																																							
2	<b>Encoder PPR</b>  Encoder Pulses Per Revolution Configures the encoder module for the Pulses Per Revolution (Encoder Lines) of the incremental encoder.	Default: 1024 Min/Max: 2 / 20000	RW	Real																																																					
3	<b>Fdbk Loss Cfg</b>  Feedback Loss Configure Configures how the drive reacts to an error status condition for the feedback. "Ignore" (0) – No action is taken. "Alarm" (1) – Type 1 alarm indicated. "Flt Minor" (2) – Minor fault indicated. If running, drive continues to run. Enable with P950 [Minor Flt Cfg]. If not enabled, acts like a major fault. "FltCoastStop" (3) – Major fault indicated. Coast to Stop.	Default: 3 = "FltCoastStop" Options: 0 = "Ignore" 1 = "Alarm" 2 = "Flt Minor" 3 = "FltCoastStop"	RW	Real																																																					
4	<b>Encoder Feedback</b> Encoder Feedback Displays the position feedback value of the encoder. This can be used as a source for the main control (Port 0) Feedback Select.	Default: 0 Min/Max: -/+2147483647	RO	Real																																																					




File	Group	No.	Display Name Full Name Description	Values	Read-Write	Data Type																																																				
Single Incremental Encoder		5	<p><b>Encoder Status</b> Encoder Status Status information for the Incremental Encoder Module.</p> <table border="1"> <thead> <tr> <th>Options</th> <th>Direction</th> <th>HomMrk Event</th> <th>HomMrk Armed</th> <th>HomeIn Event</th> <th>HomeIn Armed</th> <th>Home Input</th> <th>Inv Home In</th> <th>Marker Event</th> <th>Z Not Input</th> <th>Z Input</th> <th>B Not Input</th> <th>B Input</th> <th>A Not Input</th> <th>A Input</th> <th>A Chan Only</th> <th>Z Chan Enbl</th> </tr> </thead> <tbody> <tr> <td>Default</td> <td>0</td> <td>0</td> <td>0</td> <td>0</td> <td>0</td> <td>0</td> <td>0</td> <td>0</td> <td>0</td> <td>0</td> <td>0</td> <td>0</td> <td>0</td> <td>0</td> <td>0</td> <td>0</td> </tr> <tr> <td>Bit</td> <td>15</td> <td>14</td> <td>13</td> <td>12</td> <td>11</td> <td>10</td> <td>9</td> <td>8</td> <td>7</td> <td>6</td> <td>5</td> <td>4</td> <td>3</td> <td>2</td> <td>1</td> <td>0</td> </tr> </tbody> </table> <p>0 = Condition False 1 = Condition True</p> <p>Bit 0 "Z Chan Enbl" – State of the corresponding bit in the [Encoder Cfg] parameter.                      Bit 1 "A Chan Only" – State of the corresponding bit in the [Encoder Cfg] parameter.                      Bit 2 "A Input" – State of encoder A input signal.                      Bit 3 "A Not Input" – State of encoder A Not input signal.                      Bit 4 "B Input" – State of encoder B input signal.                      Bit 5 "B Not Input" – State of encoder B Not input signal.                      Bit 6 "Z Input" – State of encoder Z input signal.                      Bit 7 "Z Not Input" – State of encoder Z Not input signal.                      Bit 8 "Marker Event" – When channel Z (marker pulse) is used, indicates that a marker pulse is detected. Automatically cleared in the homing routine or due to clearing of faults. This bit will remain on until cleared by either the homing function, spindle orient function or clear fault. For the Single and Dual Incremental encoder options, the marker input can only be used by the homing and spindle orient functions. Clearing the encoder faults will also clear the Marker Event status. The single and dual encoder cards use the same clear fault mechanism that is used to clear the drive faults.                      Bit 9 "Inv Home In" – State of the corresponding bit in the [Encoder Cfg] parameter. When set, the home input signal will be inverted.                      Bit 10 "Home Input" – Active state of the Home Input signal. This status bit gets inverted if the "Inv Home In" bit is enabled.                      Bit 11 "HomeIn Armed" – Indicates that the homing logic is configured to latch the encoder position upon the next transition of the home input.                      Bit 12 "HomeIn Event" – Indicates that the homing logic has latched the encoder position in response to a transition of the home input.                      Bit 13 "HomMrk Armed" – Indicates that the homing logic is configured to latch the encoder position upon the next marker (Z channel) pulse.                      Bit 14 "HomMrk Event" – Indicates that the homing logic has latched the encoder position in response to a marker (Z channel) pulse.                      Bit 15 "Direction" – State of the corresponding bit in the [Encoder Cfg] parameter.</p>	Options	Direction	HomMrk Event	HomMrk Armed	HomeIn Event	HomeIn Armed	Home Input	Inv Home In	Marker Event	Z Not Input	Z Input	B Not Input	B Input	A Not Input	A Input	A Chan Only	Z Chan Enbl	Default	0	0	0	0	0	0	0	0	0	0	0	0	0	0	0	0	Bit	15	14	13	12	11	10	9	8	7	6	5	4	3	2	1	0		RO	16-bit Integer	
		Options	Direction	HomMrk Event	HomMrk Armed	HomeIn Event	HomeIn Armed	Home Input	Inv Home In	Marker Event	Z Not Input	Z Input	B Not Input	B Input	A Not Input	A Input	A Chan Only	Z Chan Enbl																																								
Default	0	0	0	0	0	0	0	0	0	0	0	0	0	0	0	0																																										
Bit	15	14	13	12	11	10	9	8	7	6	5	4	3	2	1	0																																										
6	<p><b>Error Status</b> Error Status Status information that will result in a feedback loss condition.</p> <table border="1"> <thead> <tr> <th>Options</th> <th>SI Comm Loss</th> <th>Reserved</th> <th>Reserved</th> <th>Reserved</th> <th>Reserved</th> <th>Reserved</th> <th>Reserved</th> <th>Reserved</th> <th>Reserved</th> <th>Reserved</th> <th>Reserved</th> <th>Reserved</th> <th>Reserved</th> <th>Reserved</th> <th>Quad Loss</th> <th>Phase Loss</th> <th>Open Wire</th> </tr> </thead> <tbody> <tr> <td>Default</td> <td>0</td> <td>0</td> <td>0</td> <td>0</td> <td>0</td> <td>0</td> <td>0</td> <td>0</td> <td>0</td> <td>0</td> <td>0</td> <td>0</td> <td>0</td> <td>0</td> <td>0</td> <td>0</td> <td>0</td> </tr> <tr> <td>Bit</td> <td>15</td> <td>14</td> <td>13</td> <td>12</td> <td>11</td> <td>10</td> <td>9</td> <td>8</td> <td>7</td> <td>6</td> <td>5</td> <td>4</td> <td>3</td> <td>2</td> <td>1</td> <td>0</td> <td></td> </tr> </tbody> </table> <p>0 = Condition False 1 = Condition True</p> <p>Bit 0 "Open Wire" – Indicates that an input signal (A, B or Z) is in the same state as its complement (A Not, B Not, Z Not). For open wire detection to work, the encoder signals must be differential (not single ended). The Z channel is only checked when enabled. See P1 [Encoder Cfg].                      Bit 1 "Phase Loss" – Indicates that more than 30 phase loss (open wire) events have occurred over an 8 msec time period. The same restrictions apply as on [Encoder Cfg] Bit 0. The Z channel will be ignored if not enabled. Checking for phase loss on the Z channel is only done when the Z channel is enabled.                      Bit 2 "Quad Loss" – Quadrature loss events occur when simultaneous edge transitions occur on both the A and B encoder channels. Indicates that more than 10 quad loss events over a 8 msec time period are detected. Only valid when both A and B channels are used (not 'A Chan Only' in [Encoder Cfg]).                      Bit 15 "SI Comm Loss" – Indicates a communication loss between the main control board and the encoder module over the Serial Interface backplane.</p>	Options	SI Comm Loss	Reserved	Reserved	Reserved	Reserved	Reserved	Reserved	Reserved	Reserved	Reserved	Reserved	Reserved	Reserved	Reserved	Quad Loss	Phase Loss	Open Wire	Default	0	0	0	0	0	0	0	0	0	0	0	0	0	0	0	0	0	Bit	15	14	13	12	11	10	9	8	7	6	5	4	3	2	1	0			RO	16-bit Integer
Options	SI Comm Loss	Reserved	Reserved	Reserved	Reserved	Reserved	Reserved	Reserved	Reserved	Reserved	Reserved	Reserved	Reserved	Reserved	Quad Loss	Phase Loss	Open Wire																																									
Default	0	0	0	0	0	0	0	0	0	0	0	0	0	0	0	0	0																																									
Bit	15	14	13	12	11	10	9	8	7	6	5	4	3	2	1	0																																										

File	Group	No.	Display Name Full Name Description	Values		Read-Write	Data Type
				Default:	Min/Max:		
Single Incremental Encoder		7	<b>Phase Loss Count</b> Phase Loss Count Displays the total number of encoder errors detected by the encoder card every 1 millisecond sample interval. These values are reset to zero every 1 millisecond. Diagnostic Items are available for the encoder that show the errors counted over 8 milliseconds as well as the peak error values. The peak values are reset when the drive faults are cleared.	Default: 0	Min/Max: 0 / 127	RO	Real
		8	<b>Quad Loss Count</b> Displays the total number of encoder errors detected by the encoder card every 1 millisecond sample interval. These values are reset to zero every 1 millisecond. Diagnostic Items are available for the encoder that show the errors counted over 8 milliseconds as well as the peak error values. The peak values are reset when the drive faults are cleared.	Default: 0	Min/Max: 0 / 15	RO	Real


## Dual Incremental Encoder Module Parameters

File	Group	No.	Display Name Full Name Description	Values	Read-Write	Data Type																																																			
Dual Incremental Encoder	Encoder 0	1	<b>Enc 0 Cfg</b>  Encoder 0 Configure Configures the position direction, speed calculation method, signal type and active encoder channels used for Encoder 0 (primary encoder).  Options <table border="1" style="margin-left: 20px;"> <thead> <tr> <th></th> <th>Reserved</th> <th>Reserved</th> <th>Reserved</th> <th>Reserved</th> <th>Reserved</th> <th>Reserved</th> <th>Reserved</th> <th>Reserved</th> <th>Reserved</th> <th>Reserved</th> <th>Direction</th> <th>Single Ended</th> <th>Reserved</th> <th>Edge Mode</th> <th>A Chan Only</th> <th>Z Chan Enbl</th> </tr> </thead> <tbody> <tr> <td>Default</td> <td>0</td> <td>0</td> <td>0</td> <td>0</td> <td>0</td> <td>0</td> <td>0</td> <td>0</td> <td>0</td> <td>0</td> <td>0</td> <td>0</td> <td>0</td> <td>0</td> <td>0</td> <td>0</td> </tr> <tr> <td>Bit</td> <td>15</td> <td>14</td> <td>13</td> <td>12</td> <td>11</td> <td>10</td> <td>9</td> <td>8</td> <td>7</td> <td>6</td> <td>5</td> <td>4</td> <td>3</td> <td>2</td> <td>1</td> <td>0</td> </tr> </tbody> </table> 0 = Condition False 1 = Condition True  Bit 0 "Z Channel Enbl" – Configures the Channel Z to be used and monitored for Phase Loss. A value of 0 = the Z channel will be ignored. Bit 1 "A Chan Only" – Configures the module to use only the A channel, and ignore the B channel. In this mode, direction cannot be determined, and the position counter will always count up. Bit 2 "Edge Mode" – Configure the module to use AB edge time data for speed calculation rather than accumulated count. Recommended for low speed operation. Bit 4 "Single Ended" – Configure when the A Quad B encoder has single ended signals. In this mode, Phase Loss detection is disabled. 0 = Differential, 1 = Single Ended Bit 5 "Direction" – Inverts the feedback count up/down associated with a given rotation direction internally. 1 = invert, 0 = do not invert		Reserved	Reserved	Reserved	Reserved	Reserved	Reserved	Reserved	Reserved	Reserved	Reserved	Direction	Single Ended	Reserved	Edge Mode	A Chan Only	Z Chan Enbl	Default	0	0	0	0	0	0	0	0	0	0	0	0	0	0	0	0	Bit	15	14	13	12	11	10	9	8	7	6	5	4	3	2	1	0		RW	16-bit Integer
			Reserved	Reserved	Reserved	Reserved	Reserved	Reserved	Reserved	Reserved	Reserved	Reserved	Direction	Single Ended	Reserved	Edge Mode	A Chan Only	Z Chan Enbl																																							
		Default	0	0	0	0	0	0	0	0	0	0	0	0	0	0	0	0																																							
		Bit	15	14	13	12	11	10	9	8	7	6	5	4	3	2	1	0																																							
2	<b>Enc 0 PPR</b>  Encoder 0 Pulses Per Revolution Configures the encoder module's primary input (Encoder 0) for the Pulses Per Revolution (Encoder Lines) of the A Quad B Encoder. When using a permanent magnet motor, the pulses per revolution (PPR) must be an exponent of two. For example: 512, 1024, 2048, 4096, 8192...524288...	Default: 1024 Min/Max: 2 / 20000	RW	32-bit Integer																																																					
3	<b>Enc 0 FB Lss Cfg</b>  Encoder 0 Feedback Loss Configure Configures how the drive reacts to an error status condition for Encoder 0 (primary encoder). "Ignore" (0) – No action is taken. "Alarm" (1) – Type 1 alarm indicated. "Flt Minor" (2) – Minor fault indicated. If running, drive continues to run. Enable with P950 [Minor Flt Cfg]. If not enabled, acts like a major fault. "FltCoastStop" (3) – Major fault indicated. Coast to Stop.	Default: 3 = "FltCoastStop" Options: 0 = "Ignore" 1 = "Alarm" 2 = "Flt Minor" 3 = "FltCoastStop"	RW	32-bit Integer																																																					
4	<b>Enc 0 FB</b> Encoder 0 Feedback Displays the position feedback value of Encoder 0 (primary encoder). This should be used as a source for the main control (Port 0) Feedback Select.	Default: 0 Min/Max: -/+2147483647	RO	32-bit Integer																																																					

File	Group	No.	Display Name Full Name Description	Values	Read-Write	Data Type																																																																																																	
Dual Incremental Encoder	Encoder 0	5	<b>Enc 0 Sts</b> Encoder 0 Status Status information for Encoder 0. Options	<table border="1"> <thead> <tr> <th></th> <th>Reserved</th><th>Reserved</th><th>Reserved</th><th>Reserved</th><th>Reserved</th><th>Reserved</th><th>Reserved</th><th>Reserved</th><th>Reserved</th><th>Reserved</th><th>Reserved</th><th>Reserved</th><th>Reserved</th><th>Reserved</th><th>Reserved</th><th>Direction</th><th>HomMrk Event</th><th>HomMrk Armed</th><th>HomeIn Event</th><th>HomeIn Armed</th><th>Home Input</th><th>Inv Home In</th><th>Marker Event</th><th>Z Not Input</th><th>Z Input</th><th>B Not Input</th><th>B Input</th><th>A Not Input</th><th>A Input</th><th>A Chan Only</th><th>Z Chan Enbl</th> </tr> </thead> <tbody> <tr> <td>Default</td> <td>0</td><td>0</td><td>0</td><td>0</td><td>0</td><td>0</td><td>0</td><td>0</td><td>0</td><td>0</td><td>0</td><td>0</td><td>0</td><td>0</td><td>0</td><td>0</td><td>0</td><td>0</td><td>0</td><td>0</td><td>0</td><td>0</td><td>0</td><td>0</td><td>0</td><td>0</td><td>0</td><td>0</td><td>0</td><td>0</td><td>0</td> </tr> <tr> <td>Bit</td> <td>31</td><td>30</td><td>29</td><td>28</td><td>27</td><td>26</td><td>25</td><td>24</td><td>23</td><td>22</td><td>21</td><td>20</td><td>19</td><td>18</td><td>17</td><td>16</td><td>15</td><td>14</td><td>13</td><td>12</td><td>11</td><td>10</td><td>9</td><td>8</td><td>7</td><td>6</td><td>5</td><td>4</td><td>3</td><td>2</td><td>1</td><td>0</td> </tr> </tbody> </table>		Reserved	Reserved	Reserved	Reserved	Reserved	Reserved	Reserved	Reserved	Reserved	Reserved	Reserved	Reserved	Reserved	Reserved	Reserved	Direction	HomMrk Event	HomMrk Armed	HomeIn Event	HomeIn Armed	Home Input	Inv Home In	Marker Event	Z Not Input	Z Input	B Not Input	B Input	A Not Input	A Input	A Chan Only	Z Chan Enbl	Default	0	0	0	0	0	0	0	0	0	0	0	0	0	0	0	0	0	0	0	0	0	0	0	0	0	0	0	0	0	0	0	Bit	31	30	29	28	27	26	25	24	23	22	21	20	19	18	17	16	15	14	13	12	11	10	9	8	7	6	5	4	3	2	1	0	RO	32-bit Integer
			Reserved	Reserved	Reserved	Reserved	Reserved	Reserved	Reserved	Reserved	Reserved	Reserved	Reserved	Reserved	Reserved	Reserved	Reserved	Direction	HomMrk Event	HomMrk Armed	HomeIn Event	HomeIn Armed	Home Input	Inv Home In	Marker Event	Z Not Input	Z Input	B Not Input	B Input	A Not Input	A Input	A Chan Only	Z Chan Enbl																																																																						
		Default	0	0	0	0	0	0	0	0	0	0	0	0	0	0	0	0	0	0	0	0	0	0	0	0	0	0	0	0	0	0	0																																																																						
		Bit	31	30	29	28	27	26	25	24	23	22	21	20	19	18	17	16	15	14	13	12	11	10	9	8	7	6	5	4	3	2	1	0																																																																					
Bit 0 "Z Chan Enbl" – State of the corresponding bit in the [Enc 0 Cfg] parameter. Bit 1 "A Chan Only" – State of the corresponding bit in the [Enc 0 Cfg] parameter. Bit 2 "A Input" – State of encoder A input signal. Bit 3 "A Not Input" – State of encoder A Not input signal. Bit 4 "B Input" – State of encoder B input signal. Bit 5 "B Not Input" – State of encoder B Not input signal. Bit 6 "Z Input" – State of encoder Z input signal. Bit 7 "Z Not Input" – State of encoder Z Not input signal. Bit 8 "Marker Event" – When channel Z (marker pulse) is used, indicates that a marker pulse is detected. Automatically cleared in the homing routine or due to clearing of encoder faults. Bit 9 "Inv Home In" – State of the corresponding bit in the [Enc 0 Cfg] parameter. When set, the home input signal will be inverted. Bit 10 "Home Input" – Active state of the Home Input signal. This status bit gets inverted if the "Inv Home In" bit is enabled. Bit 11 "HomeIn Armed" – Indicates that the homing logic is configured to latch the encoder position upon the next transition of the home input. Bit 12 "HomeIn Event" – Indicates that the homing logic has latched the encoder position in response to a transition of the home input. Bit 13 "HomMrk Armed" – Indicates that the homing logic is configured to latch the encoder position upon the next marker (Z channel) pulse. Bit 14 "HomMrk Event" – Indicates that the homing logic has latched the encoder position in response to a marker (Z channel) pulse. Bit 15 "Direction" – State of the corresponding bit in the [Enc 0 Cfg] parameter.																																																																																																							
6	<b>Enc 0 Error Sts</b> Encoder 0 Error Status Status information that will result in a feedback loss condition for Encoder 0. Options	<table border="1"> <thead> <tr> <th></th> <th>Reserved</th><th>Reserved</th><th>Reserved</th><th>Reserved</th><th>Reserved</th><th>Reserved</th><th>Reserved</th><th>Reserved</th><th>Reserved</th><th>Reserved</th><th>Reserved</th><th>Reserved</th><th>Reserved</th><th>Reserved</th><th>Reserved</th><th>Reserved</th><th>SI Comm Loss</th><th>Reserved</th><th>Reserved</th><th>Reserved</th><th>Reserved</th><th>Reserved</th><th>Reserved</th><th>Reserved</th><th>Reserved</th><th>Reserved</th><th>Reserved</th><th>Reserved</th><th>Reserved</th><th>Quad Loss</th><th>Phase Loss</th><th>Open Wire</th> </tr> </thead> <tbody> <tr> <td>Default</td> <td>0</td><td>0</td><td>0</td><td>0</td><td>0</td><td>0</td><td>0</td><td>0</td><td>0</td><td>0</td><td>0</td><td>0</td><td>0</td><td>0</td><td>0</td><td>0</td><td>0</td><td>0</td><td>0</td><td>0</td><td>0</td><td>0</td><td>0</td><td>0</td><td>0</td><td>0</td><td>0</td><td>0</td><td>0</td><td>0</td><td>0</td> </tr> <tr> <td>Bit</td> <td>31</td><td>30</td><td>29</td><td>28</td><td>27</td><td>26</td><td>25</td><td>24</td><td>23</td><td>22</td><td>21</td><td>20</td><td>19</td><td>18</td><td>17</td><td>16</td><td>15</td><td>14</td><td>13</td><td>12</td><td>11</td><td>10</td><td>9</td><td>8</td><td>7</td><td>6</td><td>5</td><td>4</td><td>3</td><td>2</td><td>1</td><td>0</td> </tr> </tbody> </table>		Reserved	Reserved	Reserved	Reserved	Reserved	Reserved	Reserved	Reserved	Reserved	Reserved	Reserved	Reserved	Reserved	Reserved	Reserved	Reserved	SI Comm Loss	Reserved	Reserved	Reserved	Reserved	Reserved	Reserved	Reserved	Reserved	Reserved	Reserved	Reserved	Reserved	Quad Loss	Phase Loss	Open Wire	Default	0	0	0	0	0	0	0	0	0	0	0	0	0	0	0	0	0	0	0	0	0	0	0	0	0	0	0	0	0	0	0	Bit	31	30	29	28	27	26	25	24	23	22	21	20	19	18	17	16	15	14	13	12	11	10	9	8	7	6	5	4	3	2	1	0	RO	32-bit Integer	
	Reserved	Reserved	Reserved	Reserved	Reserved	Reserved	Reserved	Reserved	Reserved	Reserved	Reserved	Reserved	Reserved	Reserved	Reserved	Reserved	SI Comm Loss	Reserved	Reserved	Reserved	Reserved	Reserved	Reserved	Reserved	Reserved	Reserved	Reserved	Reserved	Reserved	Quad Loss	Phase Loss	Open Wire																																																																							
Default	0	0	0	0	0	0	0	0	0	0	0	0	0	0	0	0	0	0	0	0	0	0	0	0	0	0	0	0	0	0	0																																																																								
Bit	31	30	29	28	27	26	25	24	23	22	21	20	19	18	17	16	15	14	13	12	11	10	9	8	7	6	5	4	3	2	1	0																																																																							
Bit 1 "Phase Loss" – Indicates that more than 30 phase loss (open wire) events have occurred over an 8msec time period. The same restrictions apply as on [Enc 0 Cfg] Bit 0 "Z Chan Enbl." Bit 2 "Quad Loss" – Quadrature loss events occur when simultaneous edge transitions occur on both the A and B encoder channels. Indicates that more than 10 quad loss events over a 10 msec time period are detected. Only valid when both A and B channels are used (not 'A Chan Only' in [Enc 0 Cfg]). Bit 15 "SI Comm Loss" – Indicates a communication loss between the main control board and the encoder module over the Serial Interface backplane.																																																																																																							
7	<b>Enc 0 PhsLssCnt</b> Encoder 0 Phase Loss Count Displays the active value of the encoder module's Encoder 0 phase loss counter hardware register. Values in this register accumulated over 8 msec are used to detect Phase Loss errors.	Default: 0 Min/Max: 0 / 127	RO	32-bit Integer																																																																																																			
8	<b>Enc 0 QuadLssCnt</b> Encoder 0 Quad Loss Count Displays the active value of the encoder module's Encoder 0 quad loss counter hardware register. Values in this register accumulated over 8 msec are used to detect Quad Loss errors.	Default: 0 Min/Max: 0 / 15	RO	32-bit Integer																																																																																																			

File	Group	No.	Display Name Full Name Description	Values	Read-Write	Data Type																																																						
Dual Incremental Encoder	Encoder 1	11	<b>Enc 1 Cfg</b>  Encoder 1 Configure Configures the position direction, speed calculation method, signal type and active encoder channels used for Encoder 1 (secondary encoder). Options	<table border="1"> <thead> <tr> <th></th> <th>Reserved</th> <th>Reserved</th> <th>Reserved</th> <th>Reserved</th> <th>Reserved</th> <th>Reserved</th> <th>Reserved</th> <th>Reserved</th> <th>Reserved</th> <th>Reserved</th> <th>Reserved</th> <th>Direction</th> <th>Single Ended</th> <th>Reserved</th> <th>Edge Mode</th> <th>A Chan Only</th> <th>Z Chan Enbl</th> </tr> </thead> <tbody> <tr> <td>Default</td> <td>0</td> <td>0</td> <td>0</td> <td>0</td> <td>0</td> <td>0</td> <td>0</td> <td>0</td> <td>0</td> <td>0</td> <td>0</td> <td>0</td> <td>0</td> <td>0</td> <td>0</td> <td>0</td> <td>0</td> </tr> <tr> <td>Bit</td> <td>15</td> <td>14</td> <td>13</td> <td>12</td> <td>11</td> <td>10</td> <td>9</td> <td>8</td> <td>7</td> <td>6</td> <td>5</td> <td>4</td> <td>3</td> <td>2</td> <td>1</td> <td>0</td> <td></td> </tr> </tbody> </table> 0 = Condition False 1 = Condition True		Reserved	Reserved	Reserved	Reserved	Reserved	Reserved	Reserved	Reserved	Reserved	Reserved	Reserved	Direction	Single Ended	Reserved	Edge Mode	A Chan Only	Z Chan Enbl	Default	0	0	0	0	0	0	0	0	0	0	0	0	0	0	0	0	0	Bit	15	14	13	12	11	10	9	8	7	6	5	4	3	2	1	0			
			Reserved	Reserved	Reserved	Reserved	Reserved	Reserved	Reserved	Reserved	Reserved	Reserved	Reserved	Direction	Single Ended	Reserved	Edge Mode	A Chan Only	Z Chan Enbl																																									
		Default	0	0	0	0	0	0	0	0	0	0	0	0	0	0	0	0	0																																									
		Bit	15	14	13	12	11	10	9	8	7	6	5	4	3	2	1	0																																										
Bit 0 "Z Channel Enbl" – Configures the Channel Z to be used and monitored for Phase Loss. A value of 0 = the Z channel will be ignored. Bit 1 "A Chan Only" – Configures the module to use only the A channel, and ignore the B channel. In this mode, direction cannot be determined, and the position counter will always count up. Bit 2 "Edge Mode" – Configure the module to use AB edge time data for speed calculation rather than accumulated count. Recommended for low speed operation. Bit 4 "Single Ended" – Configure when the A Quad B encoder has single ended signals. In this mode, Phase Loss detection is disabled. 0 = Differential, 1 = Single Ended Bit 5 "Direction" – Inverts the position count up/down associated with a given rotation direction internally. 1 = invert, 0 = do not invert																																																												
12	 <b>Enc 1 PPR</b> Encoder 1 Pulses Per Revolution Configures the encoder module's secondary input (Encoder 1) for the Pulses Per Revolution (Encoder Lines) of the A Quad B Encoder. When using a permanent magnet motor, the pulses per revolution (PPR) must be an exponent of two. For example: 512, 1024, 2048, 4096, 8192...524288...	Default: 1024 Min/Max: 2 / 20000	RW	32-bit Integer																																																								
13	 <b>Enc 1 FB Lss Cfg</b> Encoder 1 Feedback Loss Configures how the drive reacts to an error status condition for Encoder 1 (secondary encoder). "Ignore" (0) – No action is taken. "Alarm" (1) – Type 1 alarm indicated. "Flt Minor" (2) – Minor fault indicated. If running, drive continues to run. Enable with P950 [Minor Flt Cfg]. If not enabled, acts like a major fault. "FltCoastStop" (3) – Major fault indicated. Coast to Stop.	Default: 3 = "FltCoastStop" Min/Max: 0 = "Ignore" 1 = "Alarm" 2 = "Flt Minor" 3 = "FltCoastStop"	RW	32-bit Integer																																																								
14	<b>Enc 1 FB</b> Encoder 1 Feedback Displays the position feedback value of Encoder 1 (secondary encoder). This should be used as a source for the main control (Port 0) Feedback Select.	Default: 0 Min/Max: -/+2147483647	RO	32-bit Integer																																																								

File	Group	No.	Display Name Full Name Description	Values	Read-Write	Data Type																																																																																																				
Dual Incremental Encoder	Encoder 1	15	<b>Enc 1 Sts</b> Encoder 1 Status Status information for Encoder 1. Options	<table border="1"> <thead> <tr> <th></th> <th>Reserved</th><th>Reserved</th><th>Reserved</th><th>Reserved</th><th>Reserved</th><th>Reserved</th><th>Reserved</th><th>Reserved</th><th>Reserved</th><th>Reserved</th><th>Reserved</th><th>Reserved</th><th>Reserved</th><th>Reserved</th><th>Reserved</th><th>Reserved</th><th>Direction</th><th>HomMrk Event</th><th>HomMrk Armed</th><th>HomeIn Event</th><th>HomeIn Armed</th><th>Home Input</th><th>Inv Home In</th><th>Marker Event</th><th>Z Not Input</th><th>Z Input</th><th>B Not Input</th><th>B Input</th><th>A Not Input</th><th>A Input</th><th>A Chan Only</th><th>Z Chan Enbl</th> </tr> </thead> <tbody> <tr> <td>Default</td> <td>0</td><td>0</td><td>0</td><td>0</td><td>0</td><td>0</td><td>0</td><td>0</td><td>0</td><td>0</td><td>0</td><td>0</td><td>0</td><td>0</td><td>0</td><td>0</td><td>0</td><td>0</td><td>0</td><td>0</td><td>0</td><td>0</td><td>0</td><td>0</td><td>0</td><td>0</td><td>0</td><td>0</td><td>0</td><td>0</td><td>0</td><td>0</td> </tr> <tr> <td>Bit</td> <td>31</td><td>30</td><td>29</td><td>28</td><td>27</td><td>26</td><td>25</td><td>24</td><td>23</td><td>22</td><td>21</td><td>20</td><td>19</td><td>18</td><td>17</td><td>16</td><td>15</td><td>14</td><td>13</td><td>12</td><td>11</td><td>10</td><td>9</td><td>8</td><td>7</td><td>6</td><td>5</td><td>4</td><td>3</td><td>2</td><td>1</td><td>0</td> </tr> </tbody> </table>		Reserved	Reserved	Reserved	Reserved	Reserved	Reserved	Reserved	Reserved	Reserved	Reserved	Reserved	Reserved	Reserved	Reserved	Reserved	Reserved	Direction	HomMrk Event	HomMrk Armed	HomeIn Event	HomeIn Armed	Home Input	Inv Home In	Marker Event	Z Not Input	Z Input	B Not Input	B Input	A Not Input	A Input	A Chan Only	Z Chan Enbl	Default	0	0	0	0	0	0	0	0	0	0	0	0	0	0	0	0	0	0	0	0	0	0	0	0	0	0	0	0	0	0	0	0	Bit	31	30	29	28	27	26	25	24	23	22	21	20	19	18	17	16	15	14	13	12	11	10	9	8	7	6	5	4	3	2	1	0	RW	32-bit Integer	
			Reserved	Reserved	Reserved	Reserved	Reserved	Reserved	Reserved	Reserved	Reserved	Reserved	Reserved	Reserved	Reserved	Reserved	Reserved	Reserved	Direction	HomMrk Event	HomMrk Armed	HomeIn Event	HomeIn Armed	Home Input	Inv Home In	Marker Event	Z Not Input	Z Input	B Not Input	B Input	A Not Input	A Input	A Chan Only	Z Chan Enbl																																																																								
		Default	0	0	0	0	0	0	0	0	0	0	0	0	0	0	0	0	0	0	0	0	0	0	0	0	0	0	0	0	0	0	0	0																																																																								
		Bit	31	30	29	28	27	26	25	24	23	22	21	20	19	18	17	16	15	14	13	12	11	10	9	8	7	6	5	4	3	2	1	0																																																																								
			Bit 0 "Z Chan Enbl" – State of the corresponding bit in the [Enc 1 Cfg] parameter. Bit 1 "A Chan Only" – State of the corresponding bit in the [Enc 1 Cfg] parameter. Bit 2 "A Input" – State of encoder A input signal. Bit 3 "A Not Input" – State of encoder A Not input signal. Bit 4 "B Input" – State of encoder B input signal. Bit 5 "B Not Input" – State of encoder B Not input signal. Bit 6 "Z Input" – State of encoder Z input signal. Bit 7 "Z Not Input" – State of encoder Z Not input signal. Bit 8 "Marker Event" – When channel Z (marker pulse) is used, indicates that a marker pulse is detected. Automatically cleared in the homing routine or due to clearing of encoder faults. Bit 9 "Inv Home In" – State of the corresponding bit in the [Enc 1 Cfg] parameter. When set, the home input signal will be inverted. Bit 10 "Home Input" – Active state of the Home Input signal. This status bit gets inverted if the "Inv Home In" bit is enabled. Bit 11 "HomeIn Armed" – Indicates that the homing logic is configured to latch the encoder position upon the next transition of the home input. Bit 12 "HomeIn Event" – Indicates that the homing logic has latched the encoder position in response to a transition of the home input. Bit 13 "HomMrk Armed" – Indicates that the homing logic is configured to latch the encoder position upon the next marker (Z channel) pulse. Bit 14 "HomMrk Event" – Indicates that the homing logic has latched the encoder position in response to a marker (Z channel) pulse. Bit 15 "Direction" – State of the corresponding bit in the [Enc 1 Cfg] parameter.																																																																																																							
			<b>Enc 1 Error Sts</b> Encoder 1 Error Status Status information that will result in a feedback loss condition for Encoder 1. Options	<table border="1"> <thead> <tr> <th></th> <th>Reserved</th><th>Reserved</th><th>Reserved</th><th>Reserved</th><th>Reserved</th><th>Reserved</th><th>Reserved</th><th>Reserved</th><th>Reserved</th><th>Reserved</th><th>Reserved</th><th>Reserved</th><th>Reserved</th><th>Reserved</th><th>Reserved</th><th>Reserved</th><th>Reserved</th><th>SI Comm Loss</th><th>Reserved</th><th>Reserved</th><th>Reserved</th><th>Reserved</th><th>Reserved</th><th>Reserved</th><th>Reserved</th><th>Reserved</th><th>Reserved</th><th>Reserved</th><th>Reserved</th><th>Reserved</th><th>Quad Loss</th><th>Phase Loss</th><th>Open Wire</th> </tr> </thead> <tbody> <tr> <td>Default</td> <td>0</td><td>0</td><td>0</td><td>0</td><td>0</td><td>0</td><td>0</td><td>0</td><td>0</td><td>0</td><td>0</td><td>0</td><td>0</td><td>0</td><td>0</td><td>0</td><td>0</td><td>0</td><td>0</td><td>0</td><td>0</td><td>0</td><td>0</td><td>0</td><td>0</td><td>0</td><td>0</td><td>0</td><td>0</td><td>0</td><td>0</td><td>0</td> </tr> <tr> <td>Bit</td> <td>31</td><td>30</td><td>29</td><td>28</td><td>27</td><td>26</td><td>25</td><td>24</td><td>23</td><td>22</td><td>21</td><td>20</td><td>19</td><td>18</td><td>17</td><td>16</td><td>15</td><td>14</td><td>13</td><td>12</td><td>11</td><td>10</td><td>9</td><td>8</td><td>7</td><td>6</td><td>5</td><td>4</td><td>3</td><td>2</td><td>1</td><td>0</td> </tr> </tbody> </table>		Reserved	Reserved	Reserved	Reserved	Reserved	Reserved	Reserved	Reserved	Reserved	Reserved	Reserved	Reserved	Reserved	Reserved	Reserved	Reserved	Reserved	SI Comm Loss	Reserved	Reserved	Reserved	Reserved	Reserved	Reserved	Reserved	Reserved	Reserved	Reserved	Reserved	Reserved	Quad Loss	Phase Loss	Open Wire	Default	0	0	0	0	0	0	0	0	0	0	0	0	0	0	0	0	0	0	0	0	0	0	0	0	0	0	0	0	0	0	0	0	Bit	31	30	29	28	27	26	25	24	23	22	21	20	19	18	17	16	15	14	13	12	11	10	9	8	7	6	5	4	3	2	1	0	RO	32-bit Integer
	Reserved	Reserved	Reserved	Reserved	Reserved	Reserved	Reserved	Reserved	Reserved	Reserved	Reserved	Reserved	Reserved	Reserved	Reserved	Reserved	Reserved	SI Comm Loss	Reserved	Reserved	Reserved	Reserved	Reserved	Reserved	Reserved	Reserved	Reserved	Reserved	Reserved	Reserved	Quad Loss	Phase Loss	Open Wire																																																																									
Default	0	0	0	0	0	0	0	0	0	0	0	0	0	0	0	0	0	0	0	0	0	0	0	0	0	0	0	0	0	0	0	0																																																																										
Bit	31	30	29	28	27	26	25	24	23	22	21	20	19	18	17	16	15	14	13	12	11	10	9	8	7	6	5	4	3	2	1	0																																																																										
			Bit 0 "Open Wire" – Indicates that an input signal (A, B or Z) is in the same state as its complement (A Not, B Not, Z Not). For open wire detection to work, the encoder signals must be differential (not single ended). The Z channel is only checked when enabled. Bit 1 "Phase Loss" – Indicates that more than 30 phase loss (open wire) events have occurred over an 8msec time period. The same restrictions apply as on [Enc 1 Cfg] Bit 0 "Z Chan Enbl." Bit 2 "Quad Loss" – Quadrature loss events occur when simultaneous edge transitions occur on both the A and B encoder channels. Indicates that more than 10 quad loss events over a 10 msec time period are detected. Only valid when both A and B channels are used (not "A Chan Only" in [Enc 1 Cfg]). Bit 15 "SI Comm Loss" – Indicates a communication loss between the main control board and the encoder module over the Serial Interface backplane.																																																																																																							
			<b>Enc 1 PhsLssCnt</b> Encoder 1 Phase Loss Count Displays the active value of the encoder module's Encoder 1 phase loss counter hardware register. Values in this register accumulated over 8 msec are used to detect Phase Loss errors.	Default: 0 Min/Max: 0 / 127	RO	32-bit Integer																																																																																																				
			<b>Enc 1 QuadLssCnt</b> Encoder 1 Quad Loss Count Displays the active value of the encoder module's Encoder 1 quad loss counter hardware register. Values in this register accumulated over 8 msec are used to detect Quad Loss errors.	Default: 0 Min/Max: 0 / 15	RO	32-bit Integer																																																																																																				

File	Group	No.	Display Name Full Name Description	Values	Read-Write	Data Type																																																							
Dual Incremental Encoder	Homing Cfg	20	<b>Homing Cfg</b>  Homing Configure Configures options for the homing function. Common to both encoders.	Options <table border="1"> <thead> <tr> <th></th> <th>Reserved</th> <th>Reserved</th> <th>Reserved</th> <th>Reserved</th> <th>Reserved</th> <th>Reserved</th> <th>Reserved</th> <th>Reserved</th> <th>Reserved</th> <th>Reserved</th> <th>Reserved</th> <th>Reserved</th> <th>Reserved</th> <th>Reserved</th> <th>Reserved</th> <th>Reserved</th> <th>Inv Home In</th> </tr> </thead> <tbody> <tr> <td>Default</td> <td>0</td> <td>0</td> <td>0</td> <td>0</td> <td>0</td> <td>0</td> <td>0</td> <td>0</td> <td>0</td> <td>0</td> <td>0</td> <td>0</td> <td>0</td> <td>0</td> <td>0</td> <td>0</td> <td>0</td> </tr> <tr> <td>Bit</td> <td>15</td> <td>14</td> <td>13</td> <td>12</td> <td>11</td> <td>10</td> <td>9</td> <td>8</td> <td>7</td> <td>6</td> <td>5</td> <td>4</td> <td>3</td> <td>2</td> <td>1</td> <td>0</td> <td></td> </tr> </tbody> </table>		Reserved	Reserved	Reserved	Reserved	Reserved	Reserved	Reserved	Reserved	Reserved	Reserved	Reserved	Reserved	Reserved	Reserved	Reserved	Reserved	Inv Home In	Default	0	0	0	0	0	0	0	0	0	0	0	0	0	0	0	0	0	Bit	15	14	13	12	11	10	9	8	7	6	5	4	3	2	1	0		0 = Not Inverted 1 = Inverted	RW	16-bit Integer
					Reserved	Reserved	Reserved	Reserved	Reserved	Reserved	Reserved	Reserved	Reserved	Reserved	Reserved	Reserved	Reserved	Reserved	Reserved	Reserved	Inv Home In																																								
Default	0	0	0	0	0	0	0	0	0	0	0	0	0	0	0	0	0																																												
Bit	15	14	13	12	11	10	9	8	7	6	5	4	3	2	1	0																																													
Bit 0 "Inv Home In" – Inverts the home input signal.																																																													


File	Group	No.	Display Name Full Name Description	Values	Read-Write	Data Type																																																		
Dual Incremental Encoder	Module Status	21	<b>Module Sts</b> Module Status Encoder module status information. Common to both encoders.	Options <table border="1"> <thead> <tr> <th></th> <th>Reserved</th> <th>Reserved</th> <th>Reserved</th> <th>Reserved</th> <th>Reserved</th> <th>Reserved</th> <th>Reserved</th> <th>Reserved</th> <th>Reserved</th> <th>Reserved</th> <th>Reserved</th> <th>Reserved</th> <th>Reserved</th> <th>SafetyVoltHi</th> <th>Safety Mode</th> </tr> </thead> <tbody> <tr> <td>Default</td> <td>0</td> <td>0</td> <td>0</td> <td>0</td> <td>0</td> <td>0</td> <td>0</td> <td>0</td> <td>0</td> <td>0</td> <td>0</td> <td>0</td> <td>0</td> <td>0</td> <td>0</td> </tr> <tr> <td>Bit</td> <td>15</td> <td>14</td> <td>13</td> <td>12</td> <td>11</td> <td>10</td> <td>9</td> <td>8</td> <td>7</td> <td>6</td> <td>5</td> <td>4</td> <td>3</td> <td>2</td> <td>1</td> <td>0</td> </tr> </tbody> </table>		Reserved	Reserved	Reserved	Reserved	Reserved	Reserved	Reserved	Reserved	Reserved	Reserved	Reserved	Reserved	Reserved	SafetyVoltHi	Safety Mode	Default	0	0	0	0	0	0	0	0	0	0	0	0	0	0	0	Bit	15	14	13	12	11	10	9	8	7	6	5	4	3	2	1	0	0 = Cleared 1 = Set	RO	16-bit Integer
					Reserved	Reserved	Reserved	Reserved	Reserved	Reserved	Reserved	Reserved	Reserved	Reserved	Reserved	Reserved	Reserved	SafetyVoltHi	Safety Mode																																					
Default	0	0	0	0	0	0	0	0	0	0	0	0	0	0	0																																									
Bit	15	14	13	12	11	10	9	8	7	6	5	4	3	2	1	0																																								
Bit 0 "Safety Mode" – Indicates that the dip switch on the dual encoder module is configured to place its feedback signals on the SI backplane for use by the Safe Speed Monitor module. If multiple dual encoder modules are present, only one dual encoder can be configured for Safety Mode. 0 = Safety Mode Off. 1 = Safety Mode On. Bit 1 "SafetyVoltHi" – Indicates the status (configured by a jumper on the module) of the safety feedback voltage mode. 0 = 5V safety feedback mode, 1 = 12V safety feedback mode.																																																								



# Universal Feedback Module Parameters

File	Group	No.	Display Name Full Name Description	Values	Read-Write	Data Type																																																																																																			
Universal Feedback Module		1	<b>Module Sts</b> Module Status Shows error and alarm information of the Feedback Option module.  Options	<table border="1"> <thead> <tr> <th></th> <th>DPI Ready</th> <th>Sec Safety</th> <th>Pri Safety</th> <th>Reserved</th> <th>Reserved</th> <th>Reserved</th> <th>Reserved</th> <th>Reserved</th> <th>Reserved</th> <th>Reserved</th> <th>Initializing</th> <th>FB0FB1 Cflct</th> <th>Reserved</th> <th>Reserved</th> <th>Safety Cflct</th> <th>EncOut Cflct</th> <th>Reserved</th> <th>Reserved</th> <th>Firmware Err</th> <th>Hardware Err</th> <th>Reserved</th> <th>Cfg Alarm</th> <th>FB1 Alarm</th> <th>FB0 Alarm</th> <th>Reserved</th> <th>System Error</th> <th>FB1 Error</th> <th>FB0 Error</th> <th>Reserved</th> <th>Alarm Type 2</th> <th>Alarm Type 1</th> <th>Module Error</th> </tr> </thead> <tbody> <tr> <td>Default</td> <td>0</td> <td>0</td> <td>0</td> <td>0</td> <td>0</td> <td>0</td> <td>0</td> <td>0</td> <td>0</td> <td>0</td> <td>0</td> <td>0</td> <td>0</td> <td>0</td> <td>0</td> <td>0</td> <td>0</td> <td>0</td> <td>0</td> <td>0</td> <td>0</td> <td>0</td> <td>0</td> <td>0</td> <td>0</td> <td>0</td> <td>0</td> <td>0</td> <td>0</td> <td>0</td> <td>0</td> <td>0</td> </tr> <tr> <td>Bit</td> <td>31</td> <td>30</td> <td>29</td> <td>28</td> <td>27</td> <td>26</td> <td>25</td> <td>24</td> <td>23</td> <td>22</td> <td>21</td> <td>20</td> <td>19</td> <td>18</td> <td>17</td> <td>16</td> <td>15</td> <td>14</td> <td>13</td> <td>12</td> <td>11</td> <td>10</td> <td>9</td> <td>8</td> <td>7</td> <td>6</td> <td>5</td> <td>4</td> <td>3</td> <td>2</td> <td>1</td> <td>0</td> </tr> </tbody> </table>		DPI Ready	Sec Safety	Pri Safety	Reserved	Reserved	Reserved	Reserved	Reserved	Reserved	Reserved	Initializing	FB0FB1 Cflct	Reserved	Reserved	Safety Cflct	EncOut Cflct	Reserved	Reserved	Firmware Err	Hardware Err	Reserved	Cfg Alarm	FB1 Alarm	FB0 Alarm	Reserved	System Error	FB1 Error	FB0 Error	Reserved	Alarm Type 2	Alarm Type 1	Module Error	Default	0	0	0	0	0	0	0	0	0	0	0	0	0	0	0	0	0	0	0	0	0	0	0	0	0	0	0	0	0	0	0	0	Bit	31	30	29	28	27	26	25	24	23	22	21	20	19	18	17	16	15	14	13	12	11	10	9	8	7	6	5	4	3	2	1	0	RO	16-bit Integer
			DPI Ready	Sec Safety	Pri Safety	Reserved	Reserved	Reserved	Reserved	Reserved	Reserved	Reserved	Initializing	FB0FB1 Cflct	Reserved	Reserved	Safety Cflct	EncOut Cflct	Reserved	Reserved	Firmware Err	Hardware Err	Reserved	Cfg Alarm	FB1 Alarm	FB0 Alarm	Reserved	System Error	FB1 Error	FB0 Error	Reserved	Alarm Type 2	Alarm Type 1	Module Error																																																																							
		Default	0	0	0	0	0	0	0	0	0	0	0	0	0	0	0	0	0	0	0	0	0	0	0	0	0	0	0	0	0	0	0	0																																																																							
		Bit	31	30	29	28	27	26	25	24	23	22	21	20	19	18	17	16	15	14	13	12	11	10	9	8	7	6	5	4	3	2	1	0																																																																							
		0 = False 1 = True																																																																																																							
		Bit 0 "Module Error" – Indicates that the Feedback Option module has any error. This bit is set if at least one of the bits "FB0 Error", "FB1 Error", or "System Error" is set.																																																																																																							
		Bit 1 "Alarm Type 1" – Indicates that there is any alarm of type 1 active on the Feedback Option module. Bits 8 . . . 10 indicate what kind of alarm is active.																																																																																																							
		Bit 2 "Alarm Type 2" – Indicates that there is any alarm of type 2 active on the Feedback Option module. Bits 20 and 21 indicate what kind of alarm is active.																																																																																																							
		Bit 4 "FB0 Error" – Indicates that Feedback 0 has an error. This bit is set if any Feedback 0 error bit in P10 [FB0 Sts] is set. If this bit is set, Bit 0 "Module Error" is also set.																																																																																																							
		Bit 5 "FB1 Error" – Indicates that Feedback 1 has an error. This bit is set if any Feedback 1 error bit in P10 [FB1 Sts] is set. If this bit is set, Bit 0 "Module Error" is also set.																																																																																																							
Bit 6 "System Error" – Indicates that there is a feedback independent error on the Feedback Option module. Bits 12 and 13 show the type of the System Error. If this bit is set, Bit 0 "Module Error" is also set.																																																																																																									
Bit 8 "FB0 Alarm" – Indicates that feedback device 0 has an alarm. This bit is set if there is an alarm in the Feedback 0 encoder. If this bit is set, Bit 1 "Alarm Type 1" and P10 [FB0 Sts] Bit 12 "Encoder Alm" will also be set. The specific alarm condition may be shown in a status found under the diagnostics tab for the Universal Feedback Module. Separate diagnostic items are provided for both ports and for both of the following devices: EnDat and BiSS. Alarm conditions for Linear Stahl feedback devices can be found in P27 [FB0 LinStahl Sts] and P57 [FB1 LinStahl Sts].																																																																																																									
Bit 9 "FB1 Alarm" – Indicates that feedback device 1 has an alarm. This bit is set if there is an alarm in the Feedback 1 encoder. If this bit is set, Bit 1 "Alarm Type 1" and P40 [FB1 Sts] Bit 12 "Encoder Alm" will also be set. The specific alarm condition may be shown in a status found under the diagnostics tab for the Universal Feedback Module. Separate diagnostic items are provided for both ports and for both of the following devices: EnDat and BiSS. Alarm conditions for Linear Stahl feedback devices can be found in P27 [FB0 LinStahl Sts] and P57 [FB1 LinStahl Sts].																																																																																																									
Bit 10 "Cfg Alarm" – Indicates that there is a feedback independent alarm on the Feedback Option module. Bits 16 and 17 show the type of the Cfg Alarm. If this bit is set, Bit 1 "Alarm Type 1" is also set.																																																																																																									
Bit 12 "Hardware Err" – Indicates that there is a Hardware Error on the Feedback Option module. If this bit is set, Bit 6 "System Error" is also set. The hardware is self tested by the board at powerup. Specific details of the hardware failure are not available.																																																																																																									
Bit 13 "Firmware Err" – Indicates that there is a Firmware Error on the Feedback Option module. A Firmware Error occurs if the Hardware and the downloaded Firmware are not compatible. If this bit is set, Bit 6 "System Error" is also set.																																																																																																									
Bit 16 "EncOut Cflct" – If set, there is one of the following problems with the Encoder Output: <ul style="list-style-type: none"> <li>The selection in P80 [Enc Out Sel] is not possible since the required pins on the terminal blocks are already used for Feedback 0 or 1 according to P6 [FB0 Device Sel] and P36 [FB1 Device Sel].</li> <li>P80 [Enc Out Sel] is set to "Sine Cosine" and there is no signal connected to the pins 1-4 of the Terminal Block 1.</li> <li>P80 [Enc Out Sel] is set to "Sine Cosine", the value of [FBn IncAndSc PPR] is not a power of two, and the parameter P84 [Enc Out Z PPR] is not set to 0 "1 ZPulse." This is not allowed.</li> <li>P80 [Enc Out Sel] is set to "Channel X" or "Channel Y" and there is no encoder connected to that channel.</li> <li>P80 [Enc Out Sel] is set to "Channel X" or "Channel Y" and there is a linear encoder connected to this channel. If this bit is set, Bit 10 "Cfg Alarm" is also set.</li> </ul>																																																																																																									
Bit 17 "Safety Cflct" – If set, the Safety DIP switches are in an invalid position. If this bit is set, Bit 10 "Cfg Alarm" is also set.																																																																																																									
Bit 20 "FB0FB1 Cflct" – If set, the combination of the feedback selection done with the parameters P6 [FB0 Device Sel] and P36 [FB1 Device Sel] is invalid, i.e. both feedbacks have Sin-Cos-Signals (There is only place for one set of Sin-Cos-Signals on the Terminal Blocks). If this bit is set, Bit 2 "Alarm Type 2" is also set.																																																																																																									
Bit 21 "Initializing" – Indicates that the Universal Feedback State Machine is in the Initialize State. This Type 2 alarm makes sure that the motor cannot be started during the initialization state. If this bit is set, Bit 2 "Alarm Type 2" is also set.																																																																																																									
Bit 29 "Pri Safety" – Indicates that the UFB is used as primary safety module.																																																																																																									
Bit 30 "Sec Safety" – Indicates that the UFB is used as secondary safety module.																																																																																																									
Bit 31 "DPI Ready" – This bit tells the MCB if the UFB is ready for DPI communication.																																																																																																									



File	Group	No.	Display Name Full Name Description	Values	Read-Write	Data Type
Universal Feedback	Module	2	<b>Module Err Reset</b> Module Error Reset Selects the module reset type. The Universal Feedback module allows errors to be reset directly on the module. The drive's fault and alarm clear mechanisms will do this automatically and should normally be used instead of this parameter. In cases where the errors need to be reset directly, this parameter can be used. "Ready" (0) – This is the normal state for this parameter. All other states are temporary. This parameter will return to "Ready" once the requested reset operation is complete. "Clr FB Intlz" (1) – Requests the module to clear all errors and re-execute its initialization routines. Only possible when the drive is stopped. "Clear Errors" (2) – Requests the module to clear all errors without re-executing its initialization routines. Allowed if the drive is active. "FB Initlz" (3) – Requests the module to execute a software reset. Only possible when the drive is stopped.	Default: 0 = "Ready" Options: 0 = "Ready" 1 = "Clr FB Intlz" 2 = "Clear Errors" 3 = "FB Initlz"	RW	32-bit Integer

File	Group	No.	Display Name Full Name Description	Values	Read-Write	Data Type
Universal Feedback	Feedback 0	5	<b>FB0 Position</b> Feedback 0 Position Displays the position value from the feedback 0 device. For parameter 6 [FB0 Device Select] options 1, 2, 3, and 4, one revolution of the feedback = 1048576. For options 11, 12, and 13, typically one revolution of the feedback is 4 x Pulses Per Revolution.	Default: 0 Min/Max: -2147483648 / 2147483647	RO	32-bit Integer
		6	 <b>FB0 Device Sel</b> Feedback 0 Device Select Specifies the encoder type for the feedback 0 device. In some cases, there is a choice of terminal blocks to use. Channel X refers to devices wired to TB1 and Channel Y refers to TB2. "None" (0) – No feedback device selected. Use this selection if the feedback device is unused. For example, only one feedback device is present and it is used on the other feedback. "EnDat SC" (1) – EnDat encoder with sine/cosine signals (Heidenhain). Terminal block 1. "Hiperface SC" (2) – Hiperface encoder with sine/cosine signals (Stegmann). Terminal block 1. The following Hiperface Type ID codes are supported: 02h, 07h, 22h, 27h, 23h, and 37h. Refer to manufacturer data sheet for more information. "BiSS SC" (3) – BiSS encoder with sine/cosine signals. Terminal block 1. "SSI SC" (4) – SSI encoder with sine/cosine signals. Terminal block 1. "EnDat FD ChX" (5) – Full digital EnDat encoder without sine/cosine signals (Heidenhain). Terminal block 1. "EnDat FD ChY" (6) – Full digital EnDat encoder without sine/cosine signals (Heidenhain). Terminal block 2. "BiSS FD ChX" (7) – Full digital BiSS encoder without sine/cosine signals. Terminal block 1. "BiSS FD ChY" (8) – Full digital BiSS encoder without sine/cosine signals. Terminal block 2. "SSI FD ChX" (9) – SSI Full Digital ChX "SSI FD ChY" (10) – SSI Full Digital ChY "SinCos Only" (11) – Generic sine/cosine encoder. Terminal block 1. "Inc A B Z" (12) – A Quad B encoder with Z marker. Terminal block 1, Pins 17...22. "Inc SC" (13) – A Quad B encoder without Z marker. Terminal block 1, Pins 1...4. "LinTempo ChX" (14) – Temposonic linear encoder. Terminal block 1. "LinTempo ChY" (15) – Temposonic linear encoder. Terminal block 2. "LinStahl ChX" (16) – Stahl linear encoder. Terminal block 1. "LinStahl ChY" (17) – Stahl linear encoder. Terminal block 2. "LinSSI ChX" (18) – Any linear encoder with an SSI interface. Terminal block 1. "LinSSI ChY" (19) – Any linear encoder with an SSI interface. Terminal block 2.	Default: 0 = "None" Options: 0 = "None" 1 = "EnDat SC" 2 = "Hiperface SC" 3 = "BiSS SC" 4 = "SSI SC" 5 = "EnDat FD ChX" 6 = "EnDat FD ChY" 7 = "BiSS FD ChX" 8 = "BiSS FD ChY" 9 = "Reserved" (See "SSI FD ChX") 10 = "Reserved" (See "SSI FD ChY") 11 = "SinCos Only" 12 = "Inc A B Z" 13 = "Inc SC" 14 = "LinTempo ChX" 15 = "LinTempo ChY" 16 = "LinStahl ChX" 17 = "LinStahl ChY" 18 = "LinSSI ChX" 19 = "LinSSI ChY"	RW	Real

File	Group	No.	Display Name Full Name Description	Values	Read-Write	Data Type																																																			
Universal Feedback	Feedback 0	7	<b>FB0 Identify</b> Feedback 0 Identify Displays the used encoder type for the feedback 0 device, e.g. Multi turn, rotary encoder with EnDat 2.1 interface including SIN/COS incremental signals.  Options	<table border="1"> <thead> <tr> <th></th> <th>Reserved</th> <th>Stahl</th> <th>Temposonic</th> <th>SSI</th> <th>BiSS</th> <th>Hiperface</th> <th>EnDat 2p2</th> <th>EnDat 2p1</th> <th>Incremental</th> <th>Full Digital</th> <th>Sin Cos</th> <th>Enh Resol</th> <th>Multi Turn</th> <th>Single Turn</th> <th>Linear</th> <th>Rotary</th> </tr> </thead> <tbody> <tr> <td>Default</td> <td>0</td> <td>0</td> <td>0</td> <td>0</td> <td>0</td> <td>0</td> <td>0</td> <td>0</td> <td>0</td> <td>0</td> <td>0</td> <td>0</td> <td>0</td> <td>0</td> <td>0</td> <td>0</td> </tr> <tr> <td>Bit</td> <td>15</td> <td>14</td> <td>13</td> <td>12</td> <td>11</td> <td>10</td> <td>9</td> <td>8</td> <td>7</td> <td>6</td> <td>5</td> <td>4</td> <td>3</td> <td>2</td> <td>1</td> <td>0</td> </tr> </tbody> </table>		Reserved	Stahl	Temposonic	SSI	BiSS	Hiperface	EnDat 2p2	EnDat 2p1	Incremental	Full Digital	Sin Cos	Enh Resol	Multi Turn	Single Turn	Linear	Rotary	Default	0	0	0	0	0	0	0	0	0	0	0	0	0	0	0	0	Bit	15	14	13	12	11	10	9	8	7	6	5	4	3	2	1	0	RO	16-bit Integer
			Reserved	Stahl	Temposonic	SSI	BiSS	Hiperface	EnDat 2p2	EnDat 2p1	Incremental	Full Digital	Sin Cos	Enh Resol	Multi Turn	Single Turn	Linear	Rotary																																							
Default	0	0	0	0	0	0	0	0	0	0	0	0	0	0	0	0																																									
Bit	15	14	13	12	11	10	9	8	7	6	5	4	3	2	1	0																																									
			Bit 0 "Rotary" – Rotary encoder (incremental type). Bit 1 "Linear" – Linear encoder (Temposonic and Stahl type). Bit 2 "Single Turn" – Single turn absolute encoder. This encoder type can only track absolute position for one turn of the encoder shaft. Bit 3 "Multi Turn" – Multiturn absolute encoder. This encoder type can track absolute position across multiple encoder turns. Bit 4 "Enh Resol" – High resolution encoder. This bit is set if there are more than 24 bits resolution (full digital encoders) or the PPR is greater than or equal to 16384. If this bit is set, Bit 1 "24-bit Resol" in parameter [FB0 Cfg] should also be set. Bit 5 "Sin Cos" – Sine / Cosine encoder, abbreviated SC. This encoder type makes use of an analog sine/cosine signal pair. This is the analog counterpart to the A quad B incremental encoder. A fine interpolation algorithm is sometimes used to provide high resolution feedback by processing the full sine/cosine cycle. Lower resolution feedback is also implemented by counting only zero crossings. Bit 6 "Full Digital" – Full digital encoder, abbreviated FD. Refers to devices that use a serial communication interface, such as a clock and data lines to transmit data to/from the module. The analog (sine/cosine) signals are not used with a Full Digital interface. Bit 7 "Incremental" – Typically an A quad B encoder, with optional Z (marker) channel. "A Channel Only" is possible (no B channel), but rarely used because this configuration lacks direction capability. Single channel incremental could be used to provide a speed (magnitude only) reference signal. Bit 8 "EnDat 2p1" – Heidenhain absolute encoder with EnDat 2.1 command set support. EnDat is a proprietary protocol developed by Heidenhain. It is a synchronous, bidirectional serial interface. EnDat is a full digital interface. Bit 9 "EnDat 2p2" – Heidenhain EnDat 2.2 command set support. This version supports incremental as well as absolute encoders. Bit 10 "Hiperface" – Dedicated serial interface protocol for Stegmann devices. Hiperface is short for High Performance Interface. This interface makes use of both analog (sine/cosine) and digital (clock/data) signals. Bit 11 "BiSS" – Bidirectional Synchronous Serial Interface. This is an open protocol and is hardware-compatible with SSI. Both mixed SC with digital and FD types are supported. Presently, only BiSS encoders from Hengstler GmbH are supported. Bit 12 "SSI" – Synchronous Serial Interface. Only the mixed SC with digital version is supported. Rotary version is mixed analog/digital, linear version is full digital. Bit 13 "Temposonic" – Linear position sensor from MTS Systems Corp. Full digital SSI interface, absolute device uses magnetostrictive technology. Bit 14 "Stahl" – Linear position sensor from Stahl GmbH. Full digital SSI interface, absolute device uses an encoded rail.	0 = Condition False 1 = Condition True																																																					



File	Group	No.	Display Name Full Name Description	Values	Read-Write	Data Type																																																			
Universal Feedback	Feedback 0	10	<b>FBO Sts</b> Feedback 0 Status Shows feedback specific errors and alarms for the feedback 0 device. Options <table border="1" style="margin-left: 20px;"> <thead> <tr> <th></th> <th>Reserved</th> <th>Reserved</th> <th>Reserved</th> <th>Encoder Alm</th> <th>Reserved</th> <th>Unsupp Enc</th> <th>Phase Loss</th> <th>Quad Loss</th> <th>Open Wire</th> <th>SC Amplitude</th> <th>SplyVltRng</th> <th>Diagnostic</th> <th>Comm</th> <th>Timeout</th> <th>Msg Checksum</th> <th>Encoder Err</th> </tr> </thead> <tbody> <tr> <td>Default</td> <td>0</td> <td>0</td> <td>0</td> <td>0</td> <td>0</td> <td>0</td> <td>0</td> <td>0</td> <td>0</td> <td>0</td> <td>0</td> <td>0</td> <td>0</td> <td>0</td> <td>0</td> <td>0</td> </tr> <tr> <td>Bit</td> <td>15</td> <td>14</td> <td>13</td> <td>12</td> <td>11</td> <td>10</td> <td>9</td> <td>8</td> <td>7</td> <td>6</td> <td>5</td> <td>4</td> <td>3</td> <td>2</td> <td>1</td> <td>0</td> </tr> </tbody> </table> <p style="margin-left: 20px;">0 = Condition False 1 = Condition True</p> <p>Bit 0 "Encoder Err" – When set, indicates that a device specific error has occurred. Further detail can be found for each of the following devices:</p> <ul style="list-style-type: none"> <li>– Linear Stahl device on Feedback 0, see P27 [FBO LinStahl Sts] bits 4, 8...14.</li> <li>– Linear Stahl device on Feedback 1, see P57 [FB1 LinStahl Sts] bits 4, 8...14.</li> <li>– EnDat device on Feedback 0, see Universal Feedback diagnostic Item 9 [FBO EnDat Sts] bits 0...6.</li> <li>– EnDat device on Feedback 1, see Universal Feedback diagnostic Item 15 [FB1 EnDat Sts] bits 0...6.</li> <li>– BiSS device on Feedback 0, see Universal Feedback diagnostic Item 10 [FBO BiSS Sts] bits 0, 8...15.</li> <li>– BiSS device on Feedback 1, see Universal Feedback diagnostic Item 16 [FB1 BiSS Sts] bits 0, 8...15.</li> <li>– Hiperface device (either feedback, 0 or 1), see diagnostic Item 18 [Hiperface Sts] bits 0...31.</li> </ul> <p>Bit 1 "Msg Checksum" – When asserted, the module has experienced a checksum error while attempting to communicate to an encoder via the serial communication channel.</p> <p>Bit 2 "Timeout" – When asserted, the module has experienced a time out condition while attempting to communicate to the encoder via the serial communication channel.</p> <p>Bit 3 "Comm" – When asserted, there was an error (except Checksum and Time Out) while attempting to communicate to an encoder via the serial communication channel.</p> <p>Bit 4 "Diagnostic" – When asserted, the module has experienced a diagnostic test failure on power up.</p> <p>Bit 5 "SplyVltRng" – When asserted, the voltage source to the encoder is out of range.</p> <p>Bit 6 "SC Amplitude" – When asserted, the Universal Feedback option module has detected that the analog Sine/Cosine (SC) signal amplitude is out of tolerance.</p> <p>Bit 7 "Open Wire" – When asserted, the module has detected an open wire. The open wire condition for A quad B devices checks that the A, B, and Z signals are in opposite states to their corresponding NOT signals. Note that when the "A Chan Only" configuration is selected, the B signal will be ignored. If the "Z Chan Enbl" configuration is not selected, then the Z signal will be ignored. The open wire condition for sine/cosine devices checks the analog signal levels. An open wire condition will occur when both the sine and cosine signals are smaller than 0.03V. If only one of the two analog signals is missing, then a "SC Amplitude" error condition will occur.</p> <p>Bit 8 "Quad Loss" – Indicates that there is a signal quadrature error.</p> <p>Bit 9 "Phase Loss" – Indicates that an A or B signal of an A Quad B Incremental encoder was not detected.</p> <p>Bit 10 "Unsupp Enc" – Indicates that the connected encoder is not supported.</p> <p>Bit 12 "Encoder Alm" – When asserted, there is an Encoder Alarm.</p>		Reserved	Reserved	Reserved	Encoder Alm	Reserved	Unsupp Enc	Phase Loss	Quad Loss	Open Wire	SC Amplitude	SplyVltRng	Diagnostic	Comm	Timeout	Msg Checksum	Encoder Err	Default	0	0	0	0	0	0	0	0	0	0	0	0	0	0	0	0	Bit	15	14	13	12	11	10	9	8	7	6	5	4	3	2	1	0		RO	16-bit Integer
			Reserved	Reserved	Reserved	Encoder Alm	Reserved	Unsupp Enc	Phase Loss	Quad Loss	Open Wire	SC Amplitude	SplyVltRng	Diagnostic	Comm	Timeout	Msg Checksum	Encoder Err																																							
Default	0	0	0	0	0	0	0	0	0	0	0	0	0	0	0	0																																									
Bit	15	14	13	12	11	10	9	8	7	6	5	4	3	2	1	0																																									
		15	<b>FBO IncAndSC PPR</b> Feedback 0 Incremental and Sine Cosine Pulses Per Revolution Indicates the Pulses Per Revolution (Encoder Lines) of the SinCos or A Quad B encoder for the feedback 0 device. When using a permanent magnet motor, the pulses per revolution (PPR) must be an exponent of two. For example: 512, 1024, 2048, 4096, 8192...524288... For the following selections, PPR is automatically read from the encoder: <ul style="list-style-type: none"> <li>• EnDat SC</li> <li>• BiSS SC (not manually configured)</li> <li>• Hiperface SC</li> </ul> For the following selections, PPR has to be entered by the user: <ul style="list-style-type: none"> <li>• BiSS SC, Manually configured</li> <li>• Gen SinCos</li> <li>• A Quad B</li> </ul> <b>Important:</b> Parameter is only updated on power up.	Units: PPR Default: 1024 Min/Max: 1 / 100000	RW	32-bit Integer																																																			

File	Group	No.	Display Name Full Name Description	Values	Read-Write	Data Type																																																		
Universal Feedback	Feedback 0	16	<b>FB0 Inc Cfg</b>  Feedback 0 Incremental Configuration Configures Incremental Feedback for the feedback 0 device. Options <table border="1"> <thead> <tr> <th></th> <th>Reserved</th> <th>Reserved</th> <th>Reserved</th> <th>Reserved</th> <th>Reserved</th> <th>Reserved</th> <th>Reserved</th> <th>Reserved</th> <th>Reserved</th> <th>Reserved</th> <th>Reserved</th> <th>Single Ended</th> <th>Reserved</th> <th>Edge Mode</th> <th>A Chan Only</th> <th>Z Chan Enbl</th> </tr> </thead> <tbody> <tr> <td>Default</td> <td>0</td> <td>0</td> <td>0</td> <td>0</td> <td>0</td> <td>0</td> <td>0</td> <td>0</td> <td>0</td> <td>0</td> <td>0</td> <td>0</td> <td>0</td> <td>1</td> <td>0</td> <td>0</td> </tr> <tr> <td>Bit</td> <td>15</td> <td>14</td> <td>13</td> <td>12</td> <td>11</td> <td>10</td> <td>9</td> <td>8</td> <td>7</td> <td>6</td> <td>5</td> <td>4</td> <td>3</td> <td>2</td> <td>1</td> <td>0</td> </tr> </tbody> </table> 0 = Condition False 1 = Condition True		Reserved	Reserved	Reserved	Reserved	Reserved	Reserved	Reserved	Reserved	Reserved	Reserved	Reserved	Single Ended	Reserved	Edge Mode	A Chan Only	Z Chan Enbl	Default	0	0	0	0	0	0	0	0	0	0	0	0	0	1	0	0	Bit	15	14	13	12	11	10	9	8	7	6	5	4	3	2	1	0	RW	16-bit Integer
			Reserved	Reserved	Reserved	Reserved	Reserved	Reserved	Reserved	Reserved	Reserved	Reserved	Reserved	Single Ended	Reserved	Edge Mode	A Chan Only	Z Chan Enbl																																						
		Default	0	0	0	0	0	0	0	0	0	0	0	0	0	1	0	0																																						
Bit	15	14	13	12	11	10	9	8	7	6	5	4	3	2	1	0																																								
17	<b>FB0 Inc Sts</b> Feedback 0 Incremental Status Displays Incremental Feedback status for the feedback 0 device. Options <table border="1"> <thead> <tr> <th></th> <th>Reserved</th> <th>Reserved</th> <th>Reserved</th> <th>Reserved</th> <th>Reserved</th> <th>Reserved</th> <th>Reserved</th> <th>Reserved</th> <th>Z Not Input</th> <th>Z Input</th> <th>B Not Input</th> <th>B Input</th> <th>A Not Input</th> <th>A Input</th> <th>A Chan Only</th> <th>Z Chan Enbl</th> </tr> </thead> <tbody> <tr> <td>Default</td> <td>0</td> <td>0</td> <td>0</td> <td>0</td> <td>0</td> <td>0</td> <td>0</td> <td>0</td> <td>0</td> <td>0</td> <td>0</td> <td>0</td> <td>0</td> <td>0</td> <td>0</td> <td>0</td> </tr> <tr> <td>Bit</td> <td>15</td> <td>14</td> <td>13</td> <td>12</td> <td>11</td> <td>10</td> <td>9</td> <td>8</td> <td>7</td> <td>6</td> <td>5</td> <td>4</td> <td>3</td> <td>2</td> <td>1</td> <td>0</td> </tr> </tbody> </table> 0 = Condition False 1 = Condition True		Reserved	Reserved	Reserved	Reserved	Reserved	Reserved	Reserved	Reserved	Z Not Input	Z Input	B Not Input	B Input	A Not Input	A Input	A Chan Only	Z Chan Enbl	Default	0	0	0	0	0	0	0	0	0	0	0	0	0	0	0	0	Bit	15	14	13	12	11	10	9	8	7	6	5	4	3	2	1	0	RO	16-bit Integer		
	Reserved	Reserved	Reserved	Reserved	Reserved	Reserved	Reserved	Reserved	Z Not Input	Z Input	B Not Input	B Input	A Not Input	A Input	A Chan Only	Z Chan Enbl																																								
Default	0	0	0	0	0	0	0	0	0	0	0	0	0	0	0	0																																								
Bit	15	14	13	12	11	10	9	8	7	6	5	4	3	2	1	0																																								
20	<b>FB0 SSI Cfg</b>  Feedback 0 SSI Configuration Configures the communication to a SSI encoder for the feedback 0 device. Transmission format: [MSB...Position...LSB], [Error Bit]*, [Parity Bit]*. Options <table border="1"> <thead> <tr> <th></th> <th>Reserved</th> <th>Reserved</th> <th>Reserved</th> <th>Reserved</th> <th>Reserved</th> <th>Reserved</th> <th>Reserved</th> <th>Reserved</th> <th>Reserved</th> <th>Reserved</th> <th>Reserved</th> <th>DblWordQuery</th> <th>Err Bit Enbl</th> <th>Gray Code</th> <th>Reserved</th> <th>Parity Bit</th> </tr> </thead> <tbody> <tr> <td>Default</td> <td>0</td> <td>0</td> <td>0</td> <td>0</td> <td>0</td> <td>0</td> <td>0</td> <td>0</td> <td>0</td> <td>0</td> <td>0</td> <td>1</td> <td>0</td> <td>1</td> <td>0</td> <td>0</td> </tr> <tr> <td>Bit</td> <td>15</td> <td>14</td> <td>13</td> <td>12</td> <td>11</td> <td>10</td> <td>9</td> <td>8</td> <td>7</td> <td>6</td> <td>5</td> <td>4</td> <td>3</td> <td>2</td> <td>1</td> <td>0</td> </tr> </tbody> </table> 0 = Condition False 1 = Condition True		Reserved	Reserved	Reserved	Reserved	Reserved	Reserved	Reserved	Reserved	Reserved	Reserved	Reserved	DblWordQuery	Err Bit Enbl	Gray Code	Reserved	Parity Bit	Default	0	0	0	0	0	0	0	0	0	0	0	1	0	1	0	0	Bit	15	14	13	12	11	10	9	8	7	6	5	4	3	2	1	0	RW	16-bit Integer		
	Reserved	Reserved	Reserved	Reserved	Reserved	Reserved	Reserved	Reserved	Reserved	Reserved	Reserved	DblWordQuery	Err Bit Enbl	Gray Code	Reserved	Parity Bit																																								
Default	0	0	0	0	0	0	0	0	0	0	0	1	0	1	0	0																																								
Bit	15	14	13	12	11	10	9	8	7	6	5	4	3	2	1	0																																								


File	Group	No.	Display Name Full Name Description	Values	Read-Write	Data Type
Universal Feedback	Feedback 0	21	<b>FB0 SSI Resol</b> Feedback 0 SSI Resolution Configures the number of bits for the position within one revolution (resolution) of the SSI encoder for the feedback 0 device. Setting is based on the encoder specifications.	Units: Bits Default: 13 Min/Max: 8 / 32	RW	32-bit Integer
		22	<b>FB0 SSI Turns</b> Feedback 0 SSI Turns Configures the number of bits for the revolutions of the SSI encoder for the feedback 0 device. Setting is based on the encoder specifications. Set to 0 for a linear SSI encoder.	Units: Bits Default: 12 Min/Max: 0 / 16	RW	32-bit Integer
		25	<b>FB0 Lin CPR</b> Feedback 0 Linear Encoder Counts Per Revolution Specifies the counts per motor revolution for a linear encoder for the feedback 0 device. This reflects the relationship between motor feedback counts and linear feedback counts when using linear load side feedback. When a load side position feedback device is used, the counts per rev for that device must be entered using the effective change in position feedback per one motor revolution, taking into account machine mechanics. The setting for this parameter is not used by encoder but instead is used by the position control routine firmware on the main control board.	Default: 0 Min/Max: 0 / 4294967295	RW	32-bit Integer
		26	<b>FB0 Lin Upd Rate</b> Feedback Linear Update Rate Sets the sample rate for the linear channel for the feedback 0 device. This determines how often the Universal Feedback module will sample the absolute position device.	Default: 2 = "1.5 ms" Options: 0 = "0.5 ms" 1 = "1.0 ms" 2 = "1.5 ms" 3 = "2.0 ms"	RW	32-bit Integer
		27	<b>FB0 LinStahl Sts</b> Feedback 0 Linear Stahl Status Displays the error status of the linear Stahl encoder for the feedback 0 device.  Options		RO	16-bit Integer

	Reserved	No Position	Reserved	ROM Error	EPROM Error	RAM Error	Read Head 2	Read Head 1	Reserved	Reserved	Reserved	OutOfRailErr	Reserved	Reserved	OutOfRailAlm	Optics Alarm
Default	0	0	0	0	0	0	0	0	0	0	0	0	0	0	0	0
Bit	15	14	13	12	11	10	9	8	7	6	5	4	3	2	1	0


0 = Condition False  
1 = Condition True

Bit 0 "Optics Alarm" – Displays an alarm when optics require cleaning.  
 Bit 1 "OutOfRailAlm" – Indicates that the read encoder count is at the maximum value (524,287).  
 Bit 4 "OutOfRailErr" – Indicates that there is no more room between the read head and the rail.  
 Bit 8 "Read Head 1" – Indicates that the read head must be cleaned or installed correctly.  
 Bit 9 "Read Head 2" – Indicates that the read head must be cleaned or installed correctly.  
 Bit 10 "RAM Error" – Indicates a RAM error. Reading head needs to be repaired.  
 Bit 11 "EPROM Error" – Indicates an EPROM error. Reading head needs to be repaired.  
 Bit 12 "ROM Error" – Indicates a ROM error. Reading head needs to be repaired.  
 Bit 14 "No Position" – Indicates that no position value was available. Only happens after power on or reset.

File	Group	No.	Display Name Full Name Description	Values	Read-Write	Data Type
Universal Feedback	Feedback 1	35	<b>FB1 Position</b> Feedback 1 Position Displays the position value from the feedback 1 device. For parameter 36 [FB1 Device Select] options 1, 2, 3, and 4, one revolution of the feedback = 1048576. For options 11, 12, and 13, typically one revolution of the feedback is 4 x Pulses Per Revolution.	Default: 0 Min/Max: -2147483648 / 2147483647	RO	32-bit Integer
		36	 <b>FB1 Device Sel</b> Feedback 1 Device Select Specifies the encoder type for the feedback 1 device. In some cases, there is a choice of terminal blocks to use. Channel X refers to devices wired to TB1 and Channel Y refers to TB2. "None" (0) – No feedback device selected. Use this selection if the feedback device is unused. For example, only one feedback device is present and it is used on the other feedback. "EnDat SC" (1) – EnDat encoder with sine/cosine signals (Heidenhain). Terminal block 1. "Hiperface SC" (2) – Hiperface encoder with sine/cosine signals (Stegmann). Terminal block 1. The following Hiperface Type ID codes are supported: 02h, 07h, 22h, 27h, 23h, and 37h. Refer to manufacturer data sheet for more information. "BiSS SC" (3) – BiSS encoder with sine/cosine signals. Terminal block 1. "SSI SC" (4) – SSI encoder with sine/cosine signals. Terminal block 1. "EnDat FD ChX" (5) – Full digital EnDat encoder without sine/cosine signals (Heidenhain). Terminal block 1. "EnDat FD ChY" (6) – Full digital EnDat encoder without sine/cosine signals (Heidenhain). Terminal block 2. "BiSS FD ChX" (7) – Full digital BiSS encoder without sine/cosine signals. Terminal block 1. "BiSS FD ChY" (8) – Full digital BiSS encoder without sine/cosine signals. Terminal block 2. "SSI FD ChX" (9) – SSI Full Digital ChX "SSI FD ChY" (10) – SSI Full Digital ChY "SinCos Only" (11) – Generic sine/cosine encoder. Terminal block 1. "Inc A B Z" (12) – A Quad B encoder with Z marker. Terminal block 1, Pins 17...22. "Inc SC" (13) – A Quad B encoder without Z marker. Terminal block 1, Pins 1...4. "LinTempo ChX" (14) – Temposonic linear encoder. Terminal block 1. "LinTempo ChY" (15) – Temposonic linear encoder. Terminal block 2. "LinStahl ChX" (16) – Stahl linear encoder. Terminal block 1. "LinStahl ChY" (17) – Stahl linear encoder. Terminal block 2. "LinSSI ChX" (18) – Any linear encoder with an SSI interface. Terminal block 1. "LinSSI ChY" (19) – Any linear encoder with an SSI interface. Terminal block 2.	Default: 0 = "None" Options: 0 = "None" 1 = "EnDat SC" 2 = "Hiperface SC" 3 = "BiSS SC" 4 = "SSI SC" 5 = "EnDat FD ChX" 6 = "EnDat FD ChY" 7 = "BiSS FD ChX" 8 = "BiSS FD ChY" 9 = "SSI FD ChX" 10 = "SSI FD ChY" 11 = "SinCos Only" 12 = "Inc A B Z" 13 = "Inc SC" 14 = "LinTempo ChX" 15 = "LinTempo ChY" 16 = "LinStahl ChX" 17 = "LinStahl ChY" 18 = "LinSSI ChX" 19 = "LinSSI ChY"	RW	Real



File	Group	No.	Display Name Full Name Description	Values	Read-Write	Data Type																																															
Universal Feedback	Feedback 1	37	<b>FB1 Identify</b> Feedback 1 Identify Displays the used encoder type for the feedback 1 device, e.g. Multi turn, rotary encoder with EnDat 2.1 interface including SIN/COS incremental signals.		RO	16-bit Integer																																															
		<p>Options</p> <table border="1"> <thead> <tr> <th></th> <th>Reserved</th> <th>Stahl</th> <th>Temposonic</th> <th>SSI</th> <th>BiSS</th> <th>Hiperface</th> <th>EnDat 2p2</th> <th>EnDat 2p1</th> <th>Incremental</th> <th>Full Digital</th> <th>Sin Cos</th> <th>Enh Resol</th> <th>Multi Turn</th> <th>Single Turn</th> <th>Linear</th> <th>Rotary</th> </tr> </thead> <tbody> <tr> <td>Default</td> <td>0</td> <td>0</td> <td>0</td> <td>0</td> <td>0</td> <td>0</td> <td>0</td> <td>0</td> <td>0</td> <td>0</td> <td>0</td> <td>0</td> <td>0</td> <td>0</td> <td>0</td> <td>0</td> </tr> <tr> <td>Bit</td> <td>15</td> <td>14</td> <td>13</td> <td>12</td> <td>11</td> <td>10</td> <td>9</td> <td>8</td> <td>7</td> <td>6</td> <td>5</td> <td>4</td> <td>3</td> <td>2</td> <td>1</td> <td>0</td> </tr> </tbody> </table> <p>0 = Condition False 1 = Condition True</p> <p>Bit 0 "Rotary" – Rotary encoder (incremental type).            Bit 1 "Linear" – Linear encoder (Temposonic and Stahl type).            Bit 2 "Single Turn" – Single turn absolute encoder. This encoder type can only track absolute position for one turn of the encoder shaft.            Bit 3 "Multi Turn" – Multiturn absolute encoder. This encoder type can track absolute position across multiple encoder turns.            Bit 4 "Enh Resol" – High resolution encoder. This bit is set if there are more than 24 bits resolution (full digital encoders) or the PPR is greater than or equal to 16384. If this bit is set, Bit 1 "24-bit Resol" in parameter [FB0 Cfg] should also be set.            Bit 5 "Sin Cos" – Sine / Cosine encoder, abbreviated SC. This encoder type makes use of an analog sine/cosine signal pair. This is the analog counterpart to the A quad B incremental encoder. A fine interpolation algorithm is sometimes used to provide high resolution feedback by processing the full sine/cosine cycle. Lower resolution feedback is also implemented by counting only zero crossings.            Bit 6 "Full Digital" – Full digital encoder, abbreviated FD. Refers to devices that use a serial communication interface, such as a clock and data lines to transmit data to/from the module. The analog (sine/cosine) signals are not used with a Full Digital interface.            Bit 7 "Incremental" – Typically an A quad B encoder, with optional Z (marker) channel. "A Channel Only" is possible (no B channel), but rarely used because this configuration lacks direction capability. Single channel incremental could be used to provide a speed (magnitude only) reference signal.            Bit 8 "EnDat 2p1" – Heidenhain absolute encoder with EnDat 2.1 command set support. EnDat is a proprietary protocol developed by Heidenhain. It is a synchronous, bidirectional serial interface. EnData is a full digital interface.            Bit 9 "EnDat 2p2" – Heidenhain EnDat 2.2 command set support. This version supports incremental as well as absolute encoders.            Bit 10 "Hiperface" – Dedicated serial interface protocol for Stegmann devices. Hiperface is short for High Performance Interface. This interface makes use of both analog (sine/cosine) and digital (clock/data) signals.            Bit 11 "BiSS" – Bidirectional Synchronous Serial Interface. This is an open protocol and is hardware-compatible with SSI. Both mixed SC with digital and FD types are supported. Presently, only BiSS encoders from Hengstler GmbH are supported.            Bit 12 "SSI" – Synchronous Serial Interface. Only the mixed SC with digital version is supported. Rotary version is mixed analog/digital, linear version is full digital.            Bit 13 "Temposonic" – Linear position sensor from MTS Systems Corp. Full digital SSI interface, absolute device uses magnetostrictive technology.            Bit 14 "Stahl" – Linear position sensor from Stahl GmbH. Full digital SSI interface, absolute device uses an encoded rail.</p>				Reserved	Stahl	Temposonic	SSI	BiSS	Hiperface	EnDat 2p2	EnDat 2p1	Incremental	Full Digital	Sin Cos	Enh Resol	Multi Turn	Single Turn	Linear	Rotary	Default	0	0	0	0	0	0	0	0	0	0	0	0	0	0	0	0	Bit	15	14	13	12	11	10	9	8	7	6	5	4	3	2
	Reserved	Stahl	Temposonic	SSI	BiSS	Hiperface	EnDat 2p2	EnDat 2p1	Incremental	Full Digital	Sin Cos	Enh Resol	Multi Turn	Single Turn	Linear	Rotary																																					
Default	0	0	0	0	0	0	0	0	0	0	0	0	0	0	0	0																																					
Bit	15	14	13	12	11	10	9	8	7	6	5	4	3	2	1	0																																					

File	Group	No.	Display Name Full Name Description	Values	Read-Write	Data Type																																																						
Universal Feedback	Feedback 1	38	<b>FB1 Cfg</b> Feedback 1 Configuration Configure the direction, position data format, as well as the baud rate for the serial communication interface for the feedback 1 device. Options <table border="1"> <thead> <tr> <th></th> <th>Reserved</th> <th>Reserved</th> <th>Reserved</th> <th>Reserved</th> <th>Reserved</th> <th>Reserved</th> <th>Reserved</th> <th>Reserved</th> <th>Reserved</th> <th>Reserved</th> <th>Reserved</th> <th>Reserved</th> <th>Reserved</th> <th>SC Quadrant</th> <th>FD Low Baud</th> <th>24-bit Resol</th> <th>Direction</th> </tr> </thead> <tbody> <tr> <td>Default</td> <td>0</td> <td>0</td> <td>0</td> <td>0</td> <td>0</td> <td>0</td> <td>0</td> <td>0</td> <td>0</td> <td>0</td> <td>0</td> <td>0</td> <td>0</td> <td>0</td> <td>0</td> <td>0</td> <td>0</td> </tr> <tr> <td>Bit</td> <td>15</td> <td>14</td> <td>13</td> <td>12</td> <td>11</td> <td>10</td> <td>9</td> <td>8</td> <td>7</td> <td>6</td> <td>5</td> <td>4</td> <td>3</td> <td>2</td> <td>1</td> <td>0</td> <td></td> </tr> </tbody> </table> 0 = Condition False 1 = Condition True Bit 0 "Direction" – Inverts the direction internally. Bit 1 "24-bit Resol" – If set, the data format of the parameter [FB1 Position] is set to 8/24 (8 bit resolution, 24 bits position within one revolution). Otherwise, the data format is set to 12/20. It only makes sense to set this bit if the bit "Enh Resol" in parameter [FB1 Identify] is set. Bit 2 "FD Low Baud" – Reduces the communication baud rate from the default setting for the connected encoder with a serial communication channel. Bit 3 "SC Quadrant" – Reserved for future use.		Reserved	Reserved	Reserved	Reserved	Reserved	Reserved	Reserved	Reserved	Reserved	Reserved	Reserved	Reserved	Reserved	SC Quadrant	FD Low Baud	24-bit Resol	Direction	Default	0	0	0	0	0	0	0	0	0	0	0	0	0	0	0	0	0	Bit	15	14	13	12	11	10	9	8	7	6	5	4	3	2	1	0			RW	16-bit Integer
			Reserved	Reserved	Reserved	Reserved	Reserved	Reserved	Reserved	Reserved	Reserved	Reserved	Reserved	Reserved	Reserved	SC Quadrant	FD Low Baud	24-bit Resol	Direction																																									
		Default	0	0	0	0	0	0	0	0	0	0	0	0	0	0	0	0	0																																									
Bit	15	14	13	12	11	10	9	8	7	6	5	4	3	2	1	0																																												
39	 <b>FB1 Loss Cfg</b> Feedback 1 Loss Configuration Configures how the drive reacts to an error status condition on the feedback 1 device. "Ignore" (0) – No action is taken. "Alarm" (1) – Type 1 alarm indicated. "Flt Minor" (2) – Minor fault indicated. If running, drive continues to run. Enable with P950 [Minor Flt Cfg]. If not enabled, acts like a major fault. "FltCoastStop" (3) – Major fault indicated. Coast to Stop.	Default: 3 = "FltCoastStop" Options: 0 = "Ignore" 1 = "Alarm" 2 = "Flt Minor" 3 = "FltCoastStop"	RW	32-bit Integer																																																								
40	<b>FB1 Sts</b> Feedback 1 Status Shows feedback specific errors and alarms for the feedback 1 device. Options <table border="1"> <thead> <tr> <th></th> <th>Reserved</th> <th>Reserved</th> <th>Reserved</th> <th>Encoder Alm</th> <th>Reserved</th> <th>Unsupp Enc</th> <th>Phase Loss</th> <th>Quad Loss</th> <th>Open Wire</th> <th>SC Amplitude</th> <th>SplyVltRng</th> <th>Diagnostic</th> <th>Comm</th> <th>Timeout</th> <th>Msg Checksum</th> <th>Encoder Err</th> </tr> </thead> <tbody> <tr> <td>Default</td> <td>0</td> <td>0</td> <td>0</td> <td>0</td> <td>0</td> <td>0</td> <td>0</td> <td>0</td> <td>0</td> <td>0</td> <td>0</td> <td>0</td> <td>0</td> <td>0</td> <td>0</td> <td>0</td> </tr> <tr> <td>Bit</td> <td>15</td> <td>14</td> <td>13</td> <td>12</td> <td>11</td> <td>10</td> <td>9</td> <td>8</td> <td>7</td> <td>6</td> <td>5</td> <td>4</td> <td>3</td> <td>2</td> <td>1</td> <td>0</td> </tr> </tbody> </table> 0 = Condition False 1 = Condition True Bit 0 "Encoder Err" – When asserted, there is an Encoder Error. Bit 1 "Msg Checksum" – When asserted, the module has experienced a checksum error while attempting to communicate to an encoder via the serial communication channel. Bit 2 "Timeout" – When asserted, the module has experienced a time out condition while attempting to communicate to the encoder via the serial communication channel. Bit 3 "Comm" – When asserted, there was an error (except Checksum and Time Out) while attempting to communicate to an encoder via the serial communication channel. Bit 4 "Diagnostic" – When asserted, the module has experienced a diagnostic test failure on power up. Bit 5 "SplyVltRng" – When asserted, the voltage source to the encoder is out of range. Bit 6 "SC Amplitude" – When asserted, the module detected that the encoder signal amplitude is out of tolerance. Bit 7 "Open Wire" – When asserted, the module has detected an open wire. Bit 8 "Quad Loss" – Indicates that there is a signal quadrature error. Bit 9 "Phase Loss" – Indicates that an A or B signal of an A Quad B Incremental encoder is disconnected. Bit 10 "Unsupp Enc" – Indicates that the connected encoder is not supported. Bit 12 "Encoder Alm" – When asserted, there is an Encoder Alarm.		Reserved	Reserved	Reserved	Encoder Alm	Reserved	Unsupp Enc	Phase Loss	Quad Loss	Open Wire	SC Amplitude	SplyVltRng	Diagnostic	Comm	Timeout	Msg Checksum	Encoder Err	Default	0	0	0	0	0	0	0	0	0	0	0	0	0	0	0	0	Bit	15	14	13	12	11	10	9	8	7	6	5	4	3	2	1	0		RO	16-bit Integer					
	Reserved	Reserved	Reserved	Encoder Alm	Reserved	Unsupp Enc	Phase Loss	Quad Loss	Open Wire	SC Amplitude	SplyVltRng	Diagnostic	Comm	Timeout	Msg Checksum	Encoder Err																																												
Default	0	0	0	0	0	0	0	0	0	0	0	0	0	0	0	0																																												
Bit	15	14	13	12	11	10	9	8	7	6	5	4	3	2	1	0																																												

File	Group	No.	Display Name Full Name Description	Values	Read-Write	Data Type																																																			
Universal Feedback	Feedback 1	45	<b>FB1 IncAndSC PPR</b> Feedback 1 Incremental and Sine Cosine Pulses Per Revolution Indicates the Pulses Per Revolution (Encoder Lines) of the SinCos or A Quad B encoder for the feedback 1 device. For the following selections, PPR is automatically read from the encoder: <ul style="list-style-type: none"> <li>• EnDat SC</li> <li>• BiSS SC (not manually configured)</li> <li>• Hiperface SC</li> </ul> For the following selections, PPR has to be entered by the user: <ul style="list-style-type: none"> <li>• BiSS SC, Manually configured</li> <li>• Gen SinCos</li> <li>• A Quad B</li> </ul>	Units: PPR Default: 1024 Min/Max: 1 / 100000	RW	32-bit Integer																																																			
		46	<b>FB1 Inc Cfg</b> Feedback 1 Incremental Configuration Configures Incremental Feedback for the feedback 1 device.  Options <table border="1"> <thead> <tr> <th></th> <th>Reserved</th> <th>Reserved</th> <th>Reserved</th> <th>Reserved</th> <th>Reserved</th> <th>Reserved</th> <th>Reserved</th> <th>Reserved</th> <th>Reserved</th> <th>Reserved</th> <th>Reserved</th> <th>Single Ended</th> <th>Reserved</th> <th>Edge Mode</th> <th>A Chan Only</th> <th>Z Chan Enbl</th> </tr> </thead> <tbody> <tr> <td>Default</td> <td>0</td> <td>0</td> <td>0</td> <td>0</td> <td>0</td> <td>0</td> <td>0</td> <td>0</td> <td>0</td> <td>0</td> <td>0</td> <td>0</td> <td>0</td> <td>1</td> <td>0</td> <td>0</td> </tr> <tr> <td>Bit</td> <td>15</td> <td>14</td> <td>13</td> <td>12</td> <td>11</td> <td>10</td> <td>9</td> <td>8</td> <td>7</td> <td>6</td> <td>5</td> <td>4</td> <td>3</td> <td>2</td> <td>1</td> <td>0</td> </tr> </tbody> </table> 0 = Condition False 1 = Condition True  Bit 0 "Z Chan Enbl" – When set, Channel Z is also monitored for Phase Loss. When cleared, Channel Z is ignored for Phase Loss detection. Only used if [FB1 Device Sel] = "Inc A B Z." Bit 1 "A Chan Only" – When set, logic monitors only channel A. When clear, logic monitors both A and B. Bit 2 "Edge Mode" – When set, speed calc uses AB edge data. When clear, speed calc does not use AB edge data. Bit 4 "Single Ended" – This bit has to be set if the connected A Quad B encoder has single ended signals. For these encoders, the Phase Loss detection is switched off.		Reserved	Reserved	Reserved	Reserved	Reserved	Reserved	Reserved	Reserved	Reserved	Reserved	Reserved	Single Ended	Reserved	Edge Mode	A Chan Only	Z Chan Enbl	Default	0	0	0	0	0	0	0	0	0	0	0	0	0	1	0	0	Bit	15	14	13	12	11	10	9	8	7	6	5	4	3	2	1	0		RW	16-bit Integer
			Reserved	Reserved	Reserved	Reserved	Reserved	Reserved	Reserved	Reserved	Reserved	Reserved	Reserved	Single Ended	Reserved	Edge Mode	A Chan Only	Z Chan Enbl																																							
Default	0	0	0	0	0	0	0	0	0	0	0	0	0	1	0	0																																									
Bit	15	14	13	12	11	10	9	8	7	6	5	4	3	2	1	0																																									
47	<b>FB1 Inc Sts</b> Feedback 1 Incremental Status Displays Incremental Feedback status for the feedback 1 device.  Options <table border="1"> <thead> <tr> <th></th> <th>Reserved</th> <th>Reserved</th> <th>Reserved</th> <th>Reserved</th> <th>Reserved</th> <th>Reserved</th> <th>Reserved</th> <th>Reserved</th> <th>Z Not Input</th> <th>Z Input</th> <th>B Not Input</th> <th>B Input</th> <th>A Not Input</th> <th>A Input</th> <th>A Chan Only</th> <th>Z Chan Enbl</th> </tr> </thead> <tbody> <tr> <td>Default</td> <td>0</td> <td>0</td> <td>0</td> <td>0</td> <td>0</td> <td>0</td> <td>0</td> <td>0</td> <td>0</td> <td>0</td> <td>0</td> <td>0</td> <td>0</td> <td>0</td> <td>0</td> <td>0</td> </tr> <tr> <td>Bit</td> <td>15</td> <td>14</td> <td>13</td> <td>12</td> <td>11</td> <td>10</td> <td>9</td> <td>8</td> <td>7</td> <td>6</td> <td>5</td> <td>4</td> <td>3</td> <td>2</td> <td>1</td> <td>0</td> </tr> </tbody> </table> 0 = Condition False 1 = Condition True  Bit 0 "Z Chan Enbl" – Indicates that Channel Z is monitored for Phase Loss. Only used if [FB1 Device Sel] = "Inc A B Z." Bit 1 "A Chan Only" – Indicates only A channel is monitored, B channel not used. Bit 2 "A Input" – State of encoder A input signal Bit 3 "A Not Input" – State of encoder A Not input signal Bit 4 "B Input" – State of encoder B input signal Bit 5 "B Not Input" – State of encoder B Not input signal Bit 6 "Z Input" – State of encoder Z input signal Bit 7 "Z Not Input" – State of encoder Z Not input signal		Reserved	Reserved	Reserved	Reserved	Reserved	Reserved	Reserved	Reserved	Z Not Input	Z Input	B Not Input	B Input	A Not Input	A Input	A Chan Only	Z Chan Enbl	Default	0	0	0	0	0	0	0	0	0	0	0	0	0	0	0	0	Bit	15	14	13	12	11	10	9	8	7	6	5	4	3	2	1	0		RO	16-bit Integer		
	Reserved	Reserved	Reserved	Reserved	Reserved	Reserved	Reserved	Reserved	Z Not Input	Z Input	B Not Input	B Input	A Not Input	A Input	A Chan Only	Z Chan Enbl																																									
Default	0	0	0	0	0	0	0	0	0	0	0	0	0	0	0	0																																									
Bit	15	14	13	12	11	10	9	8	7	6	5	4	3	2	1	0																																									

File	Group	No.	Display Name Full Name Description	Values	Read-Write	Data Type																																																			
Universal Feedback	Feedback 1	50	<b>FB1 SSI Cfg</b> Feedback 1 SSI Configuration Configures the communication to a SSI encoder for the feedback 1 device. Transmission format: [MSB...Position...LSB], [Error Bit]*, [Parity Bit]*. Options	<table border="1"> <thead> <tr> <th></th> <th>Reserved</th> <th>Reserved</th> <th>Reserved</th> <th>Reserved</th> <th>Reserved</th> <th>Reserved</th> <th>Reserved</th> <th>Reserved</th> <th>Reserved</th> <th>Reserved</th> <th>Reserved</th> <th>DblWordQuery</th> <th>Err Bit Enbl</th> <th>Gray Code</th> <th>Reserved</th> <th>Parity Bit</th> </tr> </thead> <tbody> <tr> <td>Default</td> <td>0</td> <td>0</td> <td>0</td> <td>0</td> <td>0</td> <td>0</td> <td>0</td> <td>0</td> <td>0</td> <td>0</td> <td>0</td> <td>1</td> <td>0</td> <td>1</td> <td>0</td> <td>0</td> </tr> <tr> <td>Bit</td> <td>15</td> <td>14</td> <td>13</td> <td>12</td> <td>11</td> <td>10</td> <td>9</td> <td>8</td> <td>7</td> <td>6</td> <td>5</td> <td>4</td> <td>3</td> <td>2</td> <td>1</td> <td>0</td> </tr> </tbody> </table> <p>0 = Condition False 1 = Condition True</p>		Reserved	Reserved	Reserved	Reserved	Reserved	Reserved	Reserved	Reserved	Reserved	Reserved	Reserved	DblWordQuery	Err Bit Enbl	Gray Code	Reserved	Parity Bit	Default	0	0	0	0	0	0	0	0	0	0	0	1	0	1	0	0	Bit	15	14	13	12	11	10	9	8	7	6	5	4	3	2	1	0	RW	16-bit Integer
			Reserved	Reserved	Reserved	Reserved	Reserved	Reserved	Reserved	Reserved	Reserved	Reserved	Reserved	DblWordQuery	Err Bit Enbl	Gray Code	Reserved	Parity Bit																																							
		Default	0	0	0	0	0	0	0	0	0	0	0	1	0	1	0	0																																							
		Bit	15	14	13	12	11	10	9	8	7	6	5	4	3	2	1	0																																							
		51	<b>FB1 SSI Resol</b> Feedback 1 SSI Resolution Configures the number of bits for the position within one revolution (resolution) of the SSI encoder for the feedback 1 device.	Units: Bits Default: 13 Min/Max: 8 / 32	RW	32-bit Integer																																																			
52	<b>FB1 SSI Turns</b> Feedback 1 SSI Turns Configures the number of bits for the revolutions of the SSI encoder for the feedback 0 device. Setting is based on the encoder specifications. Set to 0 for a linear SSI encoder.	Units: Bits Default: 12 Min/Max: 0 / 16	RW	32-bit Integer																																																					
55	<b>FB1 Lin CPR</b> Feedback 1 Linear Encoder Counts Per Revolution Specifies the counts per motor revolution for a linear encoder for the feedback 1 device.	Default: 0 Min/Max: 0 / 4294967295	RW	32-bit Integer																																																					
56	<b>FB1 Lin Upd Rate</b> Feedback Linear Update Rate Sets the sample rate for the linear channel for the feedback 1 device.	Default: 2 = "1.5 ms" Options: 0 = "0.5 ms" 1 = "1.0 ms" 2 = "1.5 ms" 3 = "2.0 ms"	RW	32-bit Integer																																																					
57	<b>FB1 LinStahl Sts</b> Feedback 1 Linear Stahl Status Displays the error status of the linear Stahl encoder for the feedback 1 device. Options	<table border="1"> <thead> <tr> <th></th> <th>Reserved</th> <th>No Position</th> <th>Reserved</th> <th>ROM Error</th> <th>EPROM Error</th> <th>RAM Error</th> <th>Read Head 2</th> <th>Read Head 1</th> <th>Reserved</th> <th>Reserved</th> <th>Reserved</th> <th>OutOfRailErr</th> <th>Reserved</th> <th>Reserved</th> <th>OutOfRailAlm</th> <th>Optics Alarm</th> </tr> </thead> <tbody> <tr> <td>Default</td> <td>0</td> <td>0</td> <td>0</td> <td>0</td> <td>0</td> <td>0</td> <td>0</td> <td>0</td> <td>0</td> <td>0</td> <td>0</td> <td>0</td> <td>0</td> <td>0</td> <td>0</td> <td>0</td> </tr> <tr> <td>Bit</td> <td>15</td> <td>14</td> <td>13</td> <td>12</td> <td>11</td> <td>10</td> <td>9</td> <td>8</td> <td>7</td> <td>6</td> <td>5</td> <td>4</td> <td>3</td> <td>2</td> <td>1</td> <td>0</td> </tr> </tbody> </table> <p>0 = Condition False 1 = Condition True</p>		Reserved	No Position	Reserved	ROM Error	EPROM Error	RAM Error	Read Head 2	Read Head 1	Reserved	Reserved	Reserved	OutOfRailErr	Reserved	Reserved	OutOfRailAlm	Optics Alarm	Default	0	0	0	0	0	0	0	0	0	0	0	0	0	0	0	0	Bit	15	14	13	12	11	10	9	8	7	6	5	4	3	2	1	0	RO	16-bit Integer		
	Reserved	No Position	Reserved	ROM Error	EPROM Error	RAM Error	Read Head 2	Read Head 1	Reserved	Reserved	Reserved	OutOfRailErr	Reserved	Reserved	OutOfRailAlm	Optics Alarm																																									
Default	0	0	0	0	0	0	0	0	0	0	0	0	0	0	0	0																																									
Bit	15	14	13	12	11	10	9	8	7	6	5	4	3	2	1	0																																									

File	Group	No.	Display Name Full Name Description	Values	Read-Write	Data Type
Universal Feedback	Encoder Out	80	<b>Enc Out Sel</b> Encoder Output Select Selects the Encoder Output. If the feedback 0 or 1 device is configured as A Quad B Z then this parameter has to be set to None. Otherwise, there is an Encoder Output Alarm (Bit 16 of [Module Sts]).	Default: 0 = "None" Options: 0 = "None" 1 = "Reserved" 2 = "Sine Cosine" 3 = "Channel X" (FB0 Channel) 4 = "Channel Y" (FB1 Channel)	RW	32-bit Integer
		81	<b>Enc Out Mode</b> Encoder Output Mode Configures the Encoder Output type. "A Quad B" (0) – Sets the phase relationship between the A and B signal. "Inv A Quad B" (1) – Inverts the phase relationship between the A and B signal. Forward and reverse exchange meanings.	Default: 0 = "A Quad B" Options: 0 = "A Quad B" 1 = "Inv A Quad B"	RW	32-bit Integer
		82	<b>Enc Out FD PPR</b> Full Digital Encoder Feedback Emulator Output Pulses Per Revolution Specifies the emulated encoder output PPR when the Feedback Selection (FB device 0/1 Sel) is set to Full Digital (values 5...10). When the Feedback selection is set to Sin/Cos "SC", the Sin/Cos native PPR defines the emulated encoder outputs PPR.	Default: 1 = "1024 PPR" Options: 0 = "512 PPR" 1 = "1024 PPR" 2 = "2048 PPR" 3 = "4096 PPR"	RW	32-bit Integer
		83	<b>Enc Out Z Offset</b> Encoder Output Z Offset Configures the offset of the Z pulse for both simulated and emulated encoder output. The marker offset is specified within one revolution. Simulated mode is used for full digital rotary devices and is selected by "Channel X" and "Channel Y" in P80 [Enc Out Sel]. Emulated mode is used when "Sine Cosine" devices are selected in P80 [Enc Out Sel]. The encoder output function cannot be used with linear feedback devices.	Units: PPR Default: 0 Min/Max: 0 / 100000	RW	32-bit Integer
		84	<b>Enc Out Z PPR</b> Encoder Output Z Pulses Per Revolution Configures the number of Z-Pulses per encoder revolution. For example, if "32 Z-Pulses" (5) is selected, then 32 Z pulses will be generated for each complete revolution of the full digital input encoder. Each input encoder revolution will produce the number of output pulses specified on the A and B output channels in addition to 32 pulses on the Z output channel. The Z pulses will be evenly spaced throughout the specified number of A/B output pulses.	Default: 0 = "1 Z-Pulse" Options: 0 = "1 Z-Pulse" 1 = "2 Z-Pulses" 2 = "4 Z-Pulses" 3 = "8 Z-Pulses" 4 = "16 Z-Pulses" 5 = "32 Z-Pulses"	RW	32-bit Integer

File	Group	No.	Display Name Full Name Description	Values	Read-Write	Data Type																																																		
Universal Feedback	Registration	90	<b>Rgsn Arm</b> Registration Arm Selects Registration Latches to be used.		RW	16-bit Integer																																																		
		<table border="1"> <thead> <tr> <th>Options</th> <th>Reserved</th> <th>Reserved</th> <th>Reserved</th> <th>Reserved</th> <th>Reserved</th> <th>Reserved</th> <th>Arm Latch 10</th> <th>Arm Latch 9</th> <th>Arm Latch 8</th> <th>Arm Latch 7</th> <th>Arm Latch 6</th> <th>Arm Latch 5</th> <th>Arm Latch 4</th> <th>Arm Latch 3</th> <th>Arm Latch 2</th> <th>Arm Latch 1</th> </tr> </thead> <tbody> <tr> <td>Default</td> <td>0</td> <td>0</td> <td>0</td> <td>0</td> <td>0</td> <td>0</td> <td>0</td> <td>0</td> <td>0</td> <td>0</td> <td>0</td> <td>0</td> <td>0</td> <td>0</td> <td>0</td> <td>0</td> </tr> <tr> <td>Bit</td> <td>15</td> <td>14</td> <td>13</td> <td>12</td> <td>11</td> <td>10</td> <td>9</td> <td>8</td> <td>7</td> <td>6</td> <td>5</td> <td>4</td> <td>3</td> <td>2</td> <td>1</td> <td>0</td> </tr> </tbody> </table>			Options	Reserved	Reserved	Reserved	Reserved	Reserved	Reserved	Arm Latch 10	Arm Latch 9	Arm Latch 8	Arm Latch 7	Arm Latch 6	Arm Latch 5	Arm Latch 4	Arm Latch 3	Arm Latch 2	Arm Latch 1	Default	0	0	0	0	0	0	0	0	0	0	0	0	0	0	0	0	Bit	15	14	13	12	11	10	9	8	7	6	5	4	3	2	1	0	0 = Condition False 1 = Condition True
Options	Reserved	Reserved	Reserved	Reserved	Reserved	Reserved	Arm Latch 10	Arm Latch 9	Arm Latch 8	Arm Latch 7	Arm Latch 6	Arm Latch 5	Arm Latch 4	Arm Latch 3	Arm Latch 2	Arm Latch 1																																								
Default	0	0	0	0	0	0	0	0	0	0	0	0	0	0	0	0																																								
Bit	15	14	13	12	11	10	9	8	7	6	5	4	3	2	1	0																																								

File	Group	No.	Display Name Full Name Description	Values	Read-Write	Data Type
Universal Feedback	Registration	91	<b>Rgsn In 0 Filter</b> Registration Input 0 Filter Configures a digital filter for the registration input 0. This filter can be used to reject spurious noise. The filter works by waiting a programmed time before deciding that the signal is valid. This waiting imposes a mandatory delay in the registration signal. The filter delay is programmable in increments of 100 nanoseconds from 0 (or no delay) up to 1500 nanoseconds.	Default: 0 = "0 ns" Options: 0 = "0 ns" 1 = "100 ns" 2 = "200 ns" 3 = "300 ns" 4 = "400 ns" 5 = "500 ns" 6 = "600 ns" 7 = "700 ns" 8 = "800 ns" 9 = "900 ns" 10 = "1000 ns" 11 = "1100 ns" 12 = "1200 ns" 13 = "1300 ns" 14 = "1400 ns" 15 = "1500 ns"	RW	Real
		92	<b>Rgsn In 1 Filter</b> Registration Input 1 Filter Configures a digital filter for the registration input 1. This filter can be used to reject spurious noise. The filter works by waiting a programmed time before deciding that the signal is valid. This waiting imposes a mandatory delay in the registration signal. The filter delay is programmable in increments of 100 nanoseconds from 0 (or no delay) up to 1500 nanoseconds.	Default: 0 = "0 ns" Options: 0 = "0 ns" 1 = "100 ns" 2 = "200 ns" 3 = "300 ns" 4 = "400 ns" 5 = "500 ns" 6 = "600 ns" 7 = "700 ns" 8 = "800 ns" 9 = "900 ns" 10 = "1000 ns" 11 = "1100 ns" 12 = "1200 ns" 13 = "1300 ns" 14 = "1400 ns" 15 = "1500 ns"	RW	Real
		93	<b>Rgsn Hmln Filter</b> Registration Home Input Filter Configures a digital filter for the home input. This filter can be used to reject spurious noise. The filter works by waiting a programmed time before deciding that the signal is valid. This waiting imposes a mandatory delay in the registration signal. The filter delay is programmable in increments of 100 nanoseconds from 0 (or no delay) up to 1500 nanoseconds.	Default: 0 = "0 ns" Options: 0 = "0 ns" 1 = "100 ns" 2 = "200 ns" 3 = "300 ns" 4 = "400 ns" 5 = "500 ns" 6 = "600 ns" 7 = "700 ns" 8 = "800 ns" 9 = "900 ns" 10 = "1000 ns" 11 = "1100 ns" 12 = "1200 ns" 13 = "1300 ns" 14 = "1400 ns" 15 = "1500 ns"	RW	Real

File	Group	No.	Display Name Full Name Description	Values	Read-Write	Data Type																																																																																																
Universal Feedback	Registration	94	<b>Rgsn Sts</b> Registration Status Status of the configured registration events.		RO	16-bit Integer																																																																																																
			Options	<table border="1"> <thead> <tr> <th></th> <th>Home Input</th> <th>Rgsn Input 1</th> <th>Rgsn Input 0</th> <th>Reserved</th> <th>Reserved</th> <th>Reserved</th> <th>Reserved</th> <th>Reserved</th> <th>Reserved</th> <th>Reserved</th> <th>Reserved</th> <th>Reserved</th> <th>Latch10Found</th> <th>Latch10Armed</th> <th>Latch9 Found</th> <th>Latch9 Armed</th> <th>Latch8 Found</th> <th>Latch8 Armed</th> <th>Latch7 Found</th> <th>Latch7 Armed</th> <th>Latch6 Found</th> <th>Latch6 Armed</th> <th>Latch5 Found</th> <th>Latch5 Armed</th> <th>Latch4 Found</th> <th>Latch4 Armed</th> <th>Latch3 Found</th> <th>Latch3 Armed</th> <th>Latch2 Found</th> <th>Latch2 Armed</th> <th>Latch1 Found</th> <th>Latch1 Armed</th> </tr> </thead> <tbody> <tr> <td>Default</td> <td>0</td> <td>0</td> <td>0</td> <td>0</td> <td>0</td> <td>0</td> <td>0</td> <td>0</td> <td>0</td> <td>0</td> <td>0</td> <td>0</td> <td>0</td> <td>0</td> <td>0</td> <td>0</td> <td>0</td> <td>0</td> <td>0</td> <td>0</td> <td>0</td> <td>0</td> <td>0</td> <td>0</td> <td>0</td> <td>0</td> <td>0</td> <td>0</td> <td>0</td> <td>0</td> <td>0</td> </tr> <tr> <td>Bit</td> <td>31</td> <td>30</td> <td>29</td> <td>28</td> <td>27</td> <td>26</td> <td>25</td> <td>24</td> <td>23</td> <td>22</td> <td>21</td> <td>20</td> <td>19</td> <td>18</td> <td>17</td> <td>16</td> <td>15</td> <td>14</td> <td>13</td> <td>12</td> <td>11</td> <td>10</td> <td>9</td> <td>8</td> <td>7</td> <td>6</td> <td>5</td> <td>4</td> <td>3</td> <td>2</td> <td>1</td> <td>0</td> </tr> </tbody> </table>		Home Input	Rgsn Input 1	Rgsn Input 0	Reserved	Reserved	Reserved	Reserved	Reserved	Reserved	Reserved	Reserved	Reserved	Latch10Found	Latch10Armed	Latch9 Found	Latch9 Armed	Latch8 Found	Latch8 Armed	Latch7 Found	Latch7 Armed	Latch6 Found	Latch6 Armed	Latch5 Found	Latch5 Armed	Latch4 Found	Latch4 Armed	Latch3 Found	Latch3 Armed	Latch2 Found	Latch2 Armed	Latch1 Found	Latch1 Armed	Default	0	0	0	0	0	0	0	0	0	0	0	0	0	0	0	0	0	0	0	0	0	0	0	0	0	0	0	0	0	0	0	Bit	31	30	29	28	27	26	25	24	23	22	21	20	19	18	17	16	15	14	13	12	11	10	9	8	7	6	5	4	3	2	1	0
	Home Input	Rgsn Input 1	Rgsn Input 0	Reserved	Reserved	Reserved	Reserved	Reserved	Reserved	Reserved	Reserved	Reserved	Latch10Found	Latch10Armed	Latch9 Found	Latch9 Armed	Latch8 Found	Latch8 Armed	Latch7 Found	Latch7 Armed	Latch6 Found	Latch6 Armed	Latch5 Found	Latch5 Armed	Latch4 Found	Latch4 Armed	Latch3 Found	Latch3 Armed	Latch2 Found	Latch2 Armed	Latch1 Found	Latch1 Armed																																																																						
Default	0	0	0	0	0	0	0	0	0	0	0	0	0	0	0	0	0	0	0	0	0	0	0	0	0	0	0	0	0	0	0																																																																							
Bit	31	30	29	28	27	26	25	24	23	22	21	20	19	18	17	16	15	14	13	12	11	10	9	8	7	6	5	4	3	2	1	0																																																																						
		100	<b>Rgsn Latch1 Cfg</b>		RO	16-bit Integer																																																																																																
		103	<b>Rgsn Latch2 Cfg</b>																																																																																																			
		106	<b>Rgsn Latch3 Cfg</b>																																																																																																			
		109	<b>Rgsn Latch4 Cfg</b>																																																																																																			
		112	<b>Rgsn Latch5 Cfg</b>																																																																																																			
		115	<b>Rgsn Latch6 Cfg</b>																																																																																																			
		118	<b>Rgsn Latch7 Cfg</b>																																																																																																			
		121	<b>Rgsn Latch8 Cfg</b>																																																																																																			
		124	<b>Rgsn Latch9 Cfg</b>																																																																																																			
		127	<b>Rgsn Latch10 Cfg</b>																																																																																																			
			Registration Latch <i>n</i> Configure Configures Registration Latch <i>n</i> . The registration function consists of 10 sets of latches. The latched data includes a feedback position and associated time parameter. Time is relative to when the feedback devices were last sampled. Once the registration function has been armed, the values for these parameters are captured (latched) upon the occurrence of a trigger event. See functionality tables on following page. The registration trigger for each latch is separately configured by its Latch Configuration Parameter. Refer to <a href="#">Figure 2 on page 297</a> . The trigger logic includes two separate trigger stages. Each trigger stage is separately configured to use one of three possible registration input signals or the marker (Z pulse) of the selected feedback channel. Trigger combination logic determines how the two stages are combined to define the trigger event conditions.																																																																																																			
			Options	<table border="1"> <thead> <tr> <th></th> <th>Reserved</th> <th>Stg2EdgeFall</th> <th>Stg2EdgeRise</th> <th>Reserved</th> <th>Stg2 In b1</th> <th>Stg2 In b0</th> <th>Logic Sel b1</th> <th>Logic Sel b0</th> <th>Stg1EdgeFall</th> <th>Stg1EdgeRise</th> <th>Reserved</th> <th>Stg1 In b1</th> <th>Stg1 In b0</th> <th>Rev Capture</th> <th>Fwd Capture</th> <th>Channel Sel</th> </tr> </thead> <tbody> <tr> <td>Default</td> <td>0</td> <td>0</td> <td>0</td> <td>0</td> <td>0</td> <td>0</td> <td>0</td> <td>0</td> <td>0</td> <td>0</td> <td>0</td> <td>0</td> <td>0</td> <td>0</td> <td>0</td> <td>0</td> </tr> <tr> <td>Bit</td> <td>15</td> <td>14</td> <td>13</td> <td>12</td> <td>11</td> <td>10</td> <td>9</td> <td>8</td> <td>7</td> <td>6</td> <td>5</td> <td>4</td> <td>3</td> <td>2</td> <td>1</td> <td>0</td> </tr> </tbody> </table>		Reserved	Stg2EdgeFall	Stg2EdgeRise	Reserved	Stg2 In b1	Stg2 In b0	Logic Sel b1	Logic Sel b0	Stg1EdgeFall	Stg1EdgeRise	Reserved	Stg1 In b1	Stg1 In b0	Rev Capture	Fwd Capture	Channel Sel	Default	0	0	0	0	0	0	0	0	0	0	0	0	0	0	0	0	Bit	15	14	13	12	11	10	9	8	7	6	5	4	3	2	1	0	0 = Condition False 1 = Condition True																																														
	Reserved	Stg2EdgeFall	Stg2EdgeRise	Reserved	Stg2 In b1	Stg2 In b0	Logic Sel b1	Logic Sel b0	Stg1EdgeFall	Stg1EdgeRise	Reserved	Stg1 In b1	Stg1 In b0	Rev Capture	Fwd Capture	Channel Sel																																																																																						
Default	0	0	0	0	0	0	0	0	0	0	0	0	0	0	0	0																																																																																						
Bit	15	14	13	12	11	10	9	8	7	6	5	4	3	2	1	0																																																																																						
			Bit 0 "Channel Sel" – Channel select (FB0 or FB1). Bit 1 "Fwd Capture" – Direction select forward. Bit 2 "Rev Capture" – Direction select reverse. Bit 3 "Stg1 In b0" – Latch stage 1 input selection b0 Bit 4 "Stg1 In b1" – Latch stage 1 input selection b1 Bit 6 "Stg1EdgeRise" – Latch stage 1 edge/level select: Rising edge or high level Bit 7 "Stg1EdgeFall" – Latch stage 1 edge/level select: Falling edge or low level Bit 8 "Logic Sel b0" – Trigger stage combination logic Bit 9 "Logic Sel b1" – Trigger stage combination logic Bit 10 "Stg2 In b0" – Latch stage 2 input selection b0 Bit 11 "Stg2 In b1" – Latch stage 2 input selection b1 Bit 13 "Stg2EdgeRise" – Latch stage 2 edge/level select: Rising edge or high level Bit 14 "Stg2EdgeFall" – Latch stage 2 edge/level select: Falling edge or low level																																																																																																			

**Registration Latch Configuration Parameters**

Functionality of the Registration Latch Configuration parameter bits are listed in the tables that follow.

The registration parameters P100, P103, P106, . . . P127 can only be used when the drive's Spindle Orientation and Homing functions are active. These functions will overwrite any manually entered configuration.

**Feedback Selection**

Selects the feedback device for registration and marker pulse.

Bit 0 "Channel Sel" – 0 = Feedback 0  
1 = Feedback 1

**Direction Selection.**

Bit 2 "Rev Capture"	Bit 1 "Fwd Capture"	Description
0	1	Latch only if rotation is forward
1	0	Latch only if rotation is reverse
1	1	Latch for both forward and reverse rotation
0	0	Not defined. No latch will occur

**Trigger Stage 1**

Bit 4 "Stg1 In b1"	Bit 3 "Stg1 In b0"	Description
0	0	Registration Input 0 (TB2: -R0, +R0)
0	1	Registration Input 0 (TB2: -R1, +R1)
1	0	Home Input (TB2: -Hm, +Hm)
1	1	Marker Input of respective feedback channel. (Z channel must be activated for respective feedback channel.)

Bit 7 "Stg1EdgeFall"	Bit 6 "Stg1EdgeRise"	Description
0	0	Trigger Disabled
0	1	Trigger on rising edge or high level of signal
1	0	Trigger on falling edge or low level of signal
1	1	Trigger on either edge. (Invalid as level select. Result is always true for level select.)

**Trigger Stage Combination Logic**

The two trigger stages are combined to form the final or resulting trigger condition for each registration latch.

Bit 9 "Logic Sel b1"	Bit 8 "Logic Sel b0"	Description
0	0	None: Stage 1 Only (Stage 2 ignored)
0	1	THEN: Stage 1 Edge Transition THEN Stage 2 Edge Transition
1	0	OR: Stage 1 Edge Transition OR Stage 2 Edge Transition
1	1	AND: Stage 1 Level Transition AND Stage 2 Level Transition

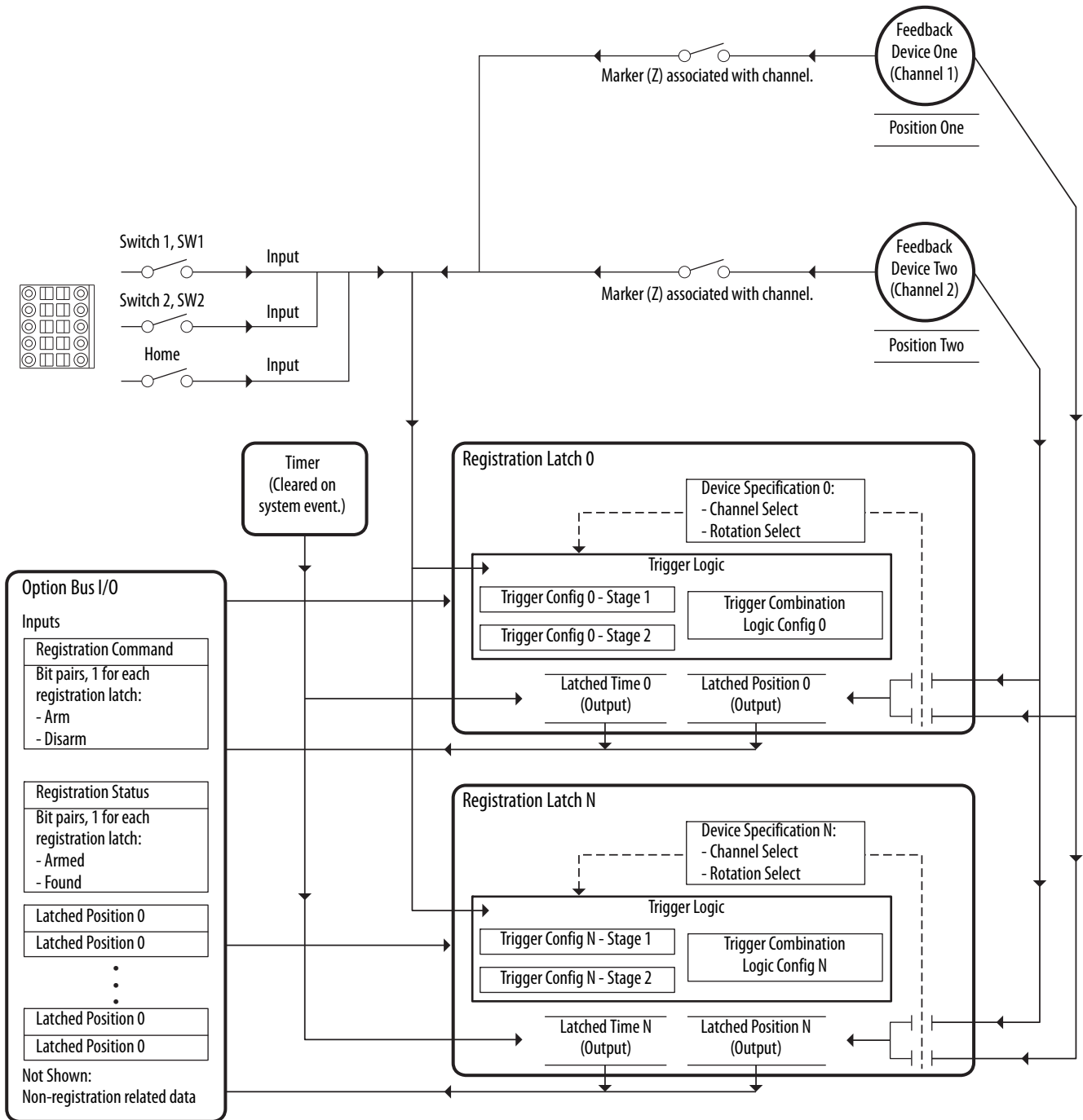
**Trigger Stage 2**

Bit 11 "Stg2 In b1"	Bit 10 "Stg2 In b0"	Description
0	0	Registration Input 0 (TB2: -R0, +R0)
0	1	Registration Input 0 (TB2: -R1, +R1)
1	0	BEFORE: Stage 1 edge causes acquisition of time and position data. Stage 2 edge causes the latch of the last acquired position.
1	1	Marker Input of respective feedback channel. (Z channel must be activated for respective feedback channel.)

Bit 14 "Stg2EdgeFall"	Bit 13 "Stg2EdgeRise"	Description
0	0	Trigger Disabled
0	1	Trigger on rising edge or high level of signal
1	0	Trigger on falling edge or low level of signal
1	1	Trigger on either edge. (Invalid as level select. Result is always true for level select.)



**Figure 2 - Registration Trigger Logic**



File	Group	No.	Display Name Full Name Description	Values		Read-Write	Data Type	
Universal Feedback	Registration	101	<b>Rgsn Latch1 Psn</b>	Default:	0	RO	32-bit Integer	
		104	<b>Rgsn Latch2 Psn</b>	Min/Max:	2147483648 / 2147483647			
		107	<b>Rgsn Latch3 Psn</b>					
		110	<b>Rgsn Latch4 Psn</b>					
		113	<b>Rgsn Latch5 Psn</b>					
		116	<b>Rgsn Latch6 Psn</b>					
		119	<b>Rgsn Latch7 Psn</b>					
		122	<b>Rgsn Latch8 Psn</b>					
		125	<b>Rgsn Latch9 Psn</b>					
		128	<b>Rgsn Latch10 Psn</b> Registration Latch X Position Position Captured during the Registration Event for Latch X.					
			102	<b>Rgsn Latch1 Time</b>	Units:	Cnt	RO	32-bit Integer
			105	<b>Rgsn Latch2 Time</b>	Default:	0		
			108	<b>Rgsn Latch3 Time</b>	Min/Max:	0 / 4294967295		
			111	<b>Rgsn Latch4 Time</b>				
			114	<b>Rgsn Latch5 Time</b>				
			117	<b>Rgsn Latch6 Time</b>				
			120	<b>Rgsn Latch7 Time</b>				
			123	<b>Rgsn Latch8 Time</b>				
			126	<b>Rgsn Latch9 Time</b>				
			129	<b>Rgsn Latch10 Time</b> Registration Latch X Time Time Captured when the Registration Event occurred for Latch X.				

## Safe Speed Monitor Module Parameters

For detailed information on the Safe Speed Monitor option, refer to the Safe Speed Monitor Option Module for PowerFlex 750-Series AC Drives Safety Reference Manual, publication [750-RM001](#).

File	Group	No.	Display Name Full Name Description	Values	Read-Write	Data Type
Safe Speed Monitor	Security	1	<b>Password</b> Password Password for Lock and Unlock function.	Default: N/A Min/Max: 0 / 4294967295	RW	32-bit Integer
		5	<b>Lock State</b> Lock State Command to lock or unlock the safety option configuration.	Default: 0 = "Unlock" Options: 0 = "Unlock" 1 = "Lock"	RW	8-bit Integer
		6	<b>Operating Mode</b> Operating Mode Command to place the system in Program or Run mode.	Default: 0 = "Program" Options: 0 = "Program" 1 = "Run" 2 = "Config Fault"	RW	8-bit Integer
		7	<b>Reset Defaults</b> Reset Defaults Resets safety option to factory defaults.	Default: 0 = "No Action" Options: 0 = "No Action" 1 = "Reset Fac" (Reset to factory defaults)	RW	8-bit Integer
		10	<b>Signature ID</b> Signature Identifier Safety configuration identifier.	Default: N/A Min/Max: 0 / 4294967295	RO	32-bit Integer
		13	<b>New Password</b> New Password 32-Bit configuration password.	Default: N/A Min/Max: 0 / 4294967295	RW	32-bit Integer
		17	<b>Password Command</b> Password Command Save new password command.	Default: 0 = "No Action" Options: 0 = "No Action" 1 = "Change PW" (Change Password) 2 = "Reset PW" (Reset Password)	RW	8-bit Integer
		18	<b>Security Code</b> Security Code Used for Reset Password command.	Default: N/A Min/Max: 0 / 4294967295	RO	32-bit Integer
		19	<b>Vendor Password</b> Vendor Password Vendor password for Reset Password command.	Default: N/A Min/Max: 0 / 65535	RW	16-bit Integer

File	Group	No.	Display Name Full Name Description	Values		Read-Write	Data Type
				Default:	Options:		
Safe Speed Monitor	Security	70	<b>Config Flt Code</b> Configuration Fault Code 0 = No Fault 1 = Password Required (Password Req) 2 = P21 [Safety Mode] value not legal based on P20 [Cascaded Config] value. 3 = P57 [Door Out Type] value not legal based on P20 [Cascaded Config] value. 4 = P46 [Stop Mon Delay] value not legal based on P45 [Safe Stop Type] value. 5 = P50 [Decel Ref Speed] value not legal based on P31 [Fbk 1 Resolution] value. 6 = P48 [Standstill Speed] value not legal based on P20 [Cascaded Config] value. 7 = P53 [LimSpd Mon Delay] value not legal based on P21 [Safety Mode] value. 8 = P55 [Safe Speed Limit] value not legal based on P21 [Safety Mode] and P31 [Fbk 1 Resolution] value. 9 = P56 [Speed Hysteresis] value not legal based on P21 [Safety Mode] value. 10 = P62 [Safe Max Speed] value not legal based on P31 [Fbk 1 Resolution] value. 11 = P42 [Direction Mon] value not legal based on P21 [Safety Mode] value. 12 = P59 [Lock Mon Enable] value not legal based on P21 [Safety Mode] value. 13 = P36 [Fbk 2 Resolution] value not legal based on P27 [Fbk Mode] value. 14 = P35 [Fbk 2 Polarity] value not legal based on P27 [Fbk Mode] value. 15 = P39 [Fbk Speed Ratio] value not legal based on P27 [Fbk Mode] value. 16 = P41 [Fbk Pos Tol] value not legal based on P27 [Fbk Mode] value. 17 = P40 [Fbk Speed Tol] value not legal based on P27 [Fbk Mode] value. 18 = P44 [Safe Stop In Typ] value not legal based on P21 [Safety Mode] value. 19 = P52 [Lim Spd In Typ] value not legal based on P21 [Safety Mode] value. 20 = P58 [DM Input Type] value not legal based on P20 [Cascaded Config] and P21 [Safety Mode] value. 21 = P54 [Enable SW In Typ] value not legal based on P21 [Safety Mode] value. 22 = P60 [Lock Mon In Type] value not legal based on P21 [Safety Mode] value and P59 [Lock Mon Enable] value. 23 = Illegal P20 [Cascaded Config] value. 24 = Illegal P22 [Reset Type] value. 25 = Reserved 26 = Illegal P45 [Safe Stop Type] value. 27 = Illegal P51 [Stop Decel Tol] value. 28 = Illegal P27 [Fbk Mode] value. 29 = Illegal P28 [Fbk 1 Type] value. 30 = Illegal P31 [Fbk 1 Resolution] value. 31 = Illegal P32 [Fbk1 Volt Mon] value. 32 = Illegal P37 [Fbk 2 Volt Mon] value. 33 = Illegal P24 [OverSpd Response] value. 34 = Reserved 36 = Unknown Error (Unknown Err).	Default: Options:	NA 0...36	RO	8-bit Integer

File	Group	No.	Display Name Full Name Description	Values	Read-Write	Data Type
Safe Speed Monitor	General	20	<b>Cascaded Config</b> Cascaded Configuration Defines whether the speed monitoring safety option is a single unit or if it occupies a first, middle, or last position in a multi-axis cascaded system. "Single" (0) - Single Unit System "Multi First" (1) - Cascaded System First Unit "Multi Mid" (2) - Cascaded System Middle Unit "Multi Last" (3) - Cascaded System Last Unit	Default: 0 = "Single" Options: 0 = "Single" 1 = "Multi First" 2 = "Multi Mid" 3 = "Multi Last"	RW	8-bit Integer
		21	<b>Safety Mode</b> Safety Mode Defines the primary operating mode of the speed monitoring safety functions. "Safe Stop" (1) - Master, Safe Stop "Safe Stop DM" (2) - Master, Safe Stop with Door Monitoring "Lim Speed" (3) - Master, Safe Limited Speed "Lim Speed DM" (4) - Master, Safe Limited Speed with Door Monitoring "Lim Speed ES" (5) - Master, Safe Limited Speed with Enabling Switch Control "LimSpd DM ES" (6) - Master, Safe Limited Speed with Door Monitoring and Enabling Switch Control "Lim Spd Stat" (7) - Master, Safe Limited Speed Status Only "Slv Safe Stp" (8) - Slave, Safe Stop "Slv Lim Spd" (9) - Slave, Safe Limited Speed "Slv Spd Stat" (10) - Slave, Safe Limited Speed Status Only	Default: 1 = "Safe Stop" Options: 0 = "Disable" 1 = "Safe Stop" 2 = "Safe Stop DM" 3 = "Lim Speed" 4 = "Lim Speed DM" 5 = "Lim Speed ES" 6 = "LimSpd DM ES" 7 = "Lim Spd Stat" 8 = "Slv Safe Stp" 9 = "Slv Lim Spd" 10 = "Slv Spd Stat"	RW	8-bit Integer
		22	<b>Reset Type</b> Reset Type Defines the type of reset used by the safety option.	Default: 2 = "Monitored" Options: 0 = "Automatic" 1 = "Manual" 2 = "Monitored" (Manual Monitored)	RW	8-bit Integer
		24	<b>OverSpd Response</b> Over Speed Response Configuration for the feedback interface sampling rate.	Default: 0 = "42 msec" Options: 0 = "42 msec" 1 = "48 msec" 2 = "60 msec" 3 = "84 msec" 4 = "132 msec" 5 = "228 msec" 6 = "420 msec"	RW	8-bit Integer
		72	<b>SS Out Mode</b> Defines whether the SS_Out output is pulse-tested. If pulse-testing is turned off for any output, the SIL, Category, and PL rating is reduced for the entire safety system.	Default: 0 = "Pulse Test" Options: 0 = "Pulse Test" 1 = "No Pulse Tst"	RW	8-bit Integer
		73	<b>SLS Out Mode</b> Defines whether the SLS_Out output is pulse-tested. If pulse-testing is turned off for any output, the SIL, Category, and PL rating is reduced for the entire safety system.	Default: 0 = "Pulse Test" Options: 0 = "Pulse Test" 1 = "No Pulse Tst"	RW	8-bit Integer

File	Group	No.	Display Name Full Name Description	Values	Read-Write	Data Type
Safe Speed Monitor	Feedback	27	<b>Fbk Mode</b> Feedback Mode Selects the number of feedback devices and the type of discrepancy checking. "Single Fbk" (0) - 1 Encoder "Dual S/P Chk" (1) - 2 Encoders with Speed and Position Discrepancy Checking "Dual Spd Chk" (2) - 2 Encoders with Speed Discrepancy Checking "Dual Pos Chk" (3) - 2 Encoders with Position Discrepancy Checking	Default: 0 = "Single Fbk" Options: 0 = "Single Fbk" 1 = "Dual S/P Chk" 2 = "Dual Spd Chk" 3 = "Dual Pos Chk"	RW	8-bit Integer
		28	<b>Fbk 1 Type</b> Feedback 1 Type Selects the type of feedback for encoder 1. When using the Safe Speed Monitor module with a 20-750-UFB-1 Universal Feedback module, set this parameter to 0 "Sine/Cosine" and ensure that the Universal Feedback module is set to a Sine/Cosine type device (P6 [FB0 Device Sel] and/or P36 [FB1 Device Sel]).	Default: 1 = "Incremental" Options: 0 = "Sine/Cosine" 1 = "Incremental"	RW	8-bit Integer
		29	<b>Fbk 1 Units</b> Feedback 1 Units Selects rotary or linear feedback for encoder 1.	Default: 0 = "Rev" Options: 0 = "Rev" (Rotary) 1 = "mm" (Linear)	RW	8-bit Integer
		30	<b>Fbk 1 Polarity</b> Feedback 1 Polarity Defines the direction polarity for encoder 1.	Default: 0 = "Normal" Options: 0 = "Normal" (Same as encoder) 1 = "Reversed"	RW	8-bit Integer
		31	<b>Fbk 1 Resolution</b> Feedback 1 Resolution Counts/Revolution. 1 . . . 65,535 pulses/revolution or pulses/mm based on rotary or linear configuration defined by P29 [Fbk 1 Units].	Default: 1024 Min/Max: 1 / 65535	RO	16-bit Integer
		32	<b>Fbk 1 Volt Mon</b> Feedback 1 Voltage Monitor Encoder 1 voltage to be monitored.	Default: 0 = Voltage not monitored Options: 0 = Voltage not monitored 5 = 5V +/- 5% 9 = 7 . . . 12V 12 = 12V +/- 5% 24 = 24V - 10% . . . 24V + 5%	RW	8-bit Integer
		33	<b>Fbk 1 Speed</b> Feedback 1 Speed Displays the output speed of encoder 1. Units based on rotary or linear configuration defined by P29 [Fbk 1 Units].	Units: RPM mm/s Min/Max: -214748364.8 / 214748364.7 RPM -214748364.8 / 214748364.7mm/s	RO	32-bit Integer
		34	<b>Fbk 2 Units</b> Feedback 2 Units Selects rotary or linear feedback for encoder 2.	Default: 0 = "Rev" Options: 0 = "Rev" (Rotary) 1 = "mm" (Linear)	RW	8-bit Integer
		35	<b>Fbk 2 Polarity</b> Feedback 2 Polarity Defines the direction polarity for encoder 2.	Default: 0 = "Normal" Options: 0 = "Normal" (Same as encoder) 1 = "Reversed"	RW	8-bit Integer
		36	<b>Fbk 2 Resolution</b> Feedback 2 Resolution Counts/Revolution. 0 . . . 65,535 pulses/revolution or pulses/mm based on rotary or linear configuration defined by P34 [Fbk 2 Units].	Default: 0 Min/Max: 0 / 65535	RW	16-bit Integer

File	Group	No.	Display Name Full Name Description	Values	Read-Write	Data Type
Safe Speed Monitor	Feedback	37	<b>Fbk 2 Volt Mon</b> Feedback 2 Voltage Monitor Encoder 2 voltage to be monitored.	Default: 0 = Voltage not monitored Options: 0 = Voltage not monitored 5 = 5V +/- 5% 9 = 7...12V 12 = 12V +/- 5% 24 = 24V - 10%...24V + 5%	RW	8-bit Integer
		38	<b>Fbk 2 Speed</b> Feedback 2 Speed Displays the output speed of encoder 2. Units based on rotary or linear configuration defined by P34 [Fbk 2 Units].	Units: RPM mm/s Min/Max: -214748364.8/214748364.7 RPM -214748364.8/214748364.7 mm/s	RO	32-bit Integer
		39	<b>Fbk Speed Ratio</b> Feedback Speed Ratio Defines the ratio of the expected speed of encoder 2 divided by the expected speed of encoder 1. Ratio based on rotary or linear configuration defined by P29 [Fbk 1 Units].	Default: 0.0000 Min/Max: 0.0000 / 10000.0	RW	Real
		40	<b>Fbk Speed Tol</b> Feedback Speed Tolerance Acceptable difference in speed between P33 [Fbk 1 Speed] and P38 [Fbk 2 Speed]. Units are based on rotary or linear configuration defined by P29 [Fbk 1 Units].	Units: RPM mm/s Min/Max: 0 / 6553.5 RPM 0 / 6553.5 mm/s	RW	16-bit Integer
		41	<b>Fbk Pos Tol</b> Feedback Position Tolerance Acceptable difference in position between encoder 1 and encoder 2. Units are based on rotary or linear configuration defined by P29 [Fbk 1 Units].	Units: Deg mm Default: 0 Min/Max: 0 / 65535 deg 0 / 65535 mm	RW	16-bit Integer
		42	<b>Direction Mon</b> Direction Monitoring Defines the allowable direction if Safe Direction Monitoring is enabled. "Pos Always" (1) – Positive always "Neg Always" (2) – Negative always "Pos in SLS" (3) – Positive during safe limited speed monitoring "Neg in SLS" (4) – Negative during safe limited speed monitoring	Default: 0 = "Disable" Options: 0 = "Disable" 1 = "Pos Always" 2 = "Neg Always" 3 = "Pos in SLS" 4 = "Neg in SLS"	RW	8-bit Integer
43	<b>Direction Tol</b> Direction Tolerance The position limit in encoder units tolerated in the wrong direction when Safe Direction Monitoring is active. Units are based on rotary or linear configuration defined by P29 [Fbk 1 Units].	Units: Deg mm Default: 10 Min/Max: 0 / 65535 deg 0 / 65535 mm	RW	16-bit Integer		

File	Group	No.	Display Name Full Name Description	Values	Read-Write	Data Type
Safe Speed Monitor	Stop	44	<b>Safe Stop Input</b> Safe Stop Input Configuration for Safe Stop input (SS_In). "2NC" (1) – Dual-channel equivalent "2NC 3s" (2) – Dual-channel equivalent 3 s "1NC+1NO" (3) – Dual-channel complementary "1NC+1NO 3s" (4) – Dual-channel complementary 3 s "2 OSSD 3s" (5) – Dual-channel SS equivalent 3 s "1NC" (6) – Single channel equivalent	Default: 1 = "2NC" Options: 0 = "Not Used" 1 = "2NC" 2 = "2NC 3s" 3 = "1NC+1NO" 4 = "1NC+1NO 3s" 5 = "2 OSSD 3s" 6 = "1NC"	RW	8-bit Integer
		45	<b>Safe Stop Type</b> Safe Stop Type Safe operating stop type selection. This defines the type of Safe Stop that is performed if the Safe Stop function is initiated by a stop type condition. "Torque Off" (0) – Safe Torque Off With Standstill Checking "Torque Off NoCk" (3) – Safe Torque Off Without Standstill Checking	Default: 0 = "Torque Off" Options: 0 = "Torque Off" 1 = "Safe Stop 1" 2 = "Safe Stop 2" 3 = "Torque Off NoCk"	RW	8-bit Integer
		46	<b>Stop Mon Delay</b> Stop Monitoring Delay Defines the monitoring delay between the request and the Max Stop Time when the request for a Safe Stop 1 or a Safe Stop 2 is initiated by an SS_In input ON to OFF transition. If the Safe Stop Type is Safe Torque Off With or Without Standstill Speed Checking, the Stop Monitor Delay must be 0 or a Invalid Configuration Fault occurs.	Units: Secs Default: 0 Min/Max: 0 / 6553.5	RW	16-bit Integer
		47	<b>Max Stop Time</b> Maximum Stop Time Defines the maximum stop delay time that is used when the Safe Stop function is initiated by a stop type condition.	Units: Secs Default: 0 Min/Max: 0 / 6553.5	RW	16-bit Integer
		48	<b>Standstill Speed</b> Standstill Speed Defines the speed limit that is used to declare motion as stopped. Units are based on rotary or linear configuration defined by P29 [Fbk 1 Units]. Not valid for Safe Torque Off without Standstill Checking.	Units: RPM mm/s Default: 0.001 Min/Max: 0.001/ 65535 RPM 000/ 65535 mm/s	RW	16-bit Integer
		49	<b>Standstill Pos</b> Standstill Position Defines the position limit window in encoder 1 degrees or mm that will be tolerated after a safe stop condition has been detected. Degrees (360° = 1 revolution) or mm based on rotary or linear configuration defined by P29 [Fbk 1 Units]. Not valid for Safe Torque Off without Standstill Checking.	Units: Deg mm Default: 10 Min/Max: 0 / 65.535 deg 0 / 65.535 mm	RW	16-bit Integer
		50	<b>Decel Ref Speed</b> Deceleration Reference Speed Determines deceleration rate to monitor for Safe Stop 1 or Safe Stop 2. Units are based on rotary or linear configuration defined by encoder 1 feedback configuration, P29 [Fbk 1 Units].	Units: RPM mm/s Default: 0 Min/Max: 0 / 65535 RPM 0 / 65535 mm/s	RW	16-bit Integer
		51	<b>Stop Decel Tol</b> Stop Deceleration Tolerance This is the acceptable tolerance above the deceleration rate set by the Decel Ref Speed parameter.	Units: % Default: 0 Min/Max: 0 / 100	RW	8-bit Integer



File	Group	No.	Display Name Full Name Description	Values	Read-Write	Data Type
Safe Speed Monitor	Limited Speed	52	<b>Lim Speed Input</b> Limited Speed Input Configuration for Safe Limited Speed input (SLS_In). "2NC" (1) – Dual-channel equivalent "2NC 3s" (2) – Dual-channel equivalent 3 s "1NC+1NO" (3) – Dual-channel complementary "1NC+1NO 3s" (4) – Dual-channel complementary 3 s "2 OSSD 3s" (5) – Dual-channel SS equivalent 3 s "1NC" (6) – Single channel equivalent	Default: 0 = "Not Used" Options: 0 = "Not Used" 1 = "2NC" 2 = "2NC 3s" 3 = "1NC+1NO" 4 = "1NC+1NO 3s" 5 = "2 OSSD 3s" 6 = "1NC"	RW	8-bit Integer
		53	<b>LimSpd Mon Delay</b> Limited Speed Monitoring Delay Defines the Safe Limited Speed Monitoring Delay between the SLS_In ON to OFF transition and the initiation of the Safe Limited Speed (SLS) or Safe Maximum Speed (SMS) monitoring.	Units: Secs Default: 0 Min/Max: 0 / 6553.5	RW	16-bit Integer
		54	<b>Enable SW Input</b> Enable Switch Input Configuration for the Enabling Switch input (ESM_In). "2NC" (1) – Dual-channel equivalent "2NC 3s" (2) – Dual-channel equivalent 3 s "1NC+1NO" (3) – Dual-channel complementary "1NC+1NO 3s" (4) – Dual-channel complementary 3 s "2 OSSD 3s" (5) – Dual-channel SS equivalent 3 s "1NC" (6) – Single channel equivalent	Default: 0 = "Not Used" Options: 0 = "Not Used" 1 = "2NC" 2 = "2NC 3s" 3 = "1NC+1NO" 4 = "1NC+1NO 3s" 5 = "2 OSSD 3s" 6 = "1NC"	RW	8-bit Integer
		55	<b>Safe Speed Limit</b> Safe Speed Limit Defines the speed limit that will be monitored in Safe Limited Speed (SLS) mode. Units are based on rotary or linear configuration defined by P29 [Fbk 1 Units].	Units: RPM mm/s Default: 0 Min/Max: 0 / 6553.5 RPM 0 / 6553.5 mm/s	RW	16-bit Integer
		56	<b>Speed Hysteresis</b> Speed Hysteresis Provides hysteresis for SLS_Out output when Safe Limited Speed monitoring is active. 0% when P21 [Safety Mode] = 1, 2, 3, 4, 5, 6, 8, or 9 10...100% when P21 [Safety Mode] = 7 or 10	Units: % Default: 0 Min/Max: 0 / 100	RW	8-bit Integer

File	Group	No.	Display Name Full Name Description	Values		Read-Write	Data Type
				Default:	Options:		
Safe Speed Monitor	Door Control	57	<b>Door Out Type</b> Door Output Type Defines the lock and unlock state for door control output (DC_Out). When Door Out Type equals power to release, DC_Out is OFF in the lock state and ON in the unlock state. When Door Out Type equals power to lock, DC_Out is ON in the lock state and OFF in the unlock state. The first and middle units of a multi-axis system must be configured as cascading (2).	Default: 0 = "Pwr to Rel"	Options: 0 = "Pwr to Rel" 1 = "Pwr to Lock" 2 = "2 Ch Sourcing"	RW	8-bit Integer
		58	<b>DM Input</b> Door Monitor Input Configuration for the Door Monitor input (DM_In). "2NC" (1) – Dual-channel equivalent "2NC 3s" (2) – Dual-channel equivalent 3 s "1NC+1NO" (3) – Dual-channel complementary "1NC+1NO 3s" (4) – Dual-channel complementary 3 s "2 OSSD 3s" (5) – Dual-channel SS equivalent 3 s "1NC" (6) – Single channel equivalent	Default: 0 = "Not Used"	Options: 0 = "Not Used" 1 = "2NC" 2 = "2NC 3s" 3 = "1NC+1NO" 4 = "1NC+1NO 3s" 5 = "2 OSSD 3s" 6 = "1NC"	RW	8-bit Integer
		59	<b>Lock Mon Enable</b> Lock Monitor Enable Lock Monitoring can only be enabled when the speed monitoring safety option is a single unit or as the first unit in a multi-axis system (P20 [Cascaded Config] = 0 or 1).	Default: 0 = "Disable"	Options: 0 = "Disable" 1 = "Enable"	RW	8-bit Integer
		60	<b>Lock Mon Input</b> Lock Monitor Input Configuration for the Lock Monitor input (LM_In). "2NC" (1) – Dual-channel equivalent "2NC 3s" (2) – Dual-channel equivalent 3 s "1NC+1NO" (3) – Dual-channel complementary "1NC+1NO 3s" (4) – Dual-channel complementary 3 s "2 OSSD 3s" (5) – Dual-channel SS equivalent 3 s "1NC" (6) – Single channel equivalent	Default: 0 = "Not Used"	Options: 0 = "Not Used" 1 = "2NC" 2 = "2NC 3s" 3 = "1NC+1NO" 4 = "1NC+1NO 3s" 5 = "2 OSSD 3s" 6 = "1NC"	RW	8-bit Integer
		74	<b>Door Out Mode</b> Door Output Mode Defines whether the DC_Out output is pulse-tested. If pulse-testing is turned off for any output, the SIL, Category, and PL rating is reduced for the entire safety system.	Default: 0 = "Pulse Test"	Options: 0 = "Pulse Test" 1 = "No Pulse Tst"	RW	8-bit Integer

File	Group	No.	Display Name Full Name Description	Values		Read-Write	Data Type
				Default:	Options:		
Safe Speed Monitor	Max Speed	61	<b>Max Speed Enable</b> Maximum Speed Enable Enable Safe Maximum Speed Monitoring.	Default: 0 = "Disable"	Options: 0 = "Disable" 1 = "Enable"	RW	8-bit Integer
		62	<b>Safe Max Speed</b> Safe Maximum Speed Defines the maximum speed limit that will be tolerated if Safe Maximum Speed monitoring is enabled.	Units: RPM mm/s Default: 0 Min/Max: 0 / 65535 RPM 0 / 65535 mm/s		RW	16-bit Integer
		63	<b>Max Spd Stop Typ</b> Maximum Speed Stop Type Defines the safe stop type that will be initiated in the event of a SMS Speed Fault. "Torque Off" (0) – Safe Torque Off With Standstill Checking "Safe Stp Typ" (1) – Safe Torque Off Without Standstill Checking	Default: 0 = "Torque Off" Options: 0 = "Torque Off" 1 = "Safe Stp Typ"		RW	8-bit Integer
		64	<b>Max Accel Enable</b> Maximum Acceleration Enable Enable Safe Maximum Acceleration Monitoring.	Default: 0 = "Disable" Options: 0 = "Disable" 1 = "Enable"		RW	8-bit Integer
		65	<b>Safe Accel Limit</b> Safe Acceleration Limit Defines the Safe Maximum Acceleration Limit, relative to encoder 1, for which the system is being monitored. Units are based on rotary or linear configuration defined by P29 [Fbk 1 Units].	Units: Rev/s <sup>2</sup> mm/s <sup>2</sup> Default: 0 Min/Max: 0 / 65535 rev/s <sup>2</sup> 0 / 65535 mm/s <sup>2</sup>		RW	16-bit Integer
		66	<b>Max Acc Stop Typ</b> Maximum Acceleration Stop Type Defines the safe stop type that will be initiated in the event of an Acceleration Fault. "Torque Off" (0) – Safe Torque Off With Standstill Checking "Safe Stp Typ" (1) – Safe Torque Off Without Standstill Checking	Default: 0 = "Torque Off" Options: 0 = "Torque Off" 1 = "Safe Stp Typ"		RW	8-bit Integer

File	Group	No.	Display Name Full Name Description	Values	Read-Write	Data Type																																																																																																
Safe Speed Monitor	Faults	67	<b>Fault Status</b> Fault Status Bit-encoded faults.		RO	32-bit Integer																																																																																																
			Options <table border="1"> <thead> <tr> <th></th> <th>Reserved</th> <th>Reserved</th> <th>Reserved</th> <th>Fbk 2 V Flt</th> <th>Fbk 1 V Flt</th> <th>ESM Mon Flt</th> <th>ESM In Flt</th> <th>Lock Mon Flt</th> <th>LM In Flt</th> <th>DC Out Flt</th> <th>Door Mon Flt</th> <th>DM In Flt</th> <th>Dir Flt</th> <th>Accel Flt</th> <th>SMS Spd Flt</th> <th>SLS Spd Flt</th> <th>SLS Out Flt</th> <th>SLS In Flt</th> <th>Mov in Stop</th> <th>Stop Spd Flt</th> <th>Decel Flt</th> <th>SS Out Flt</th> <th>SS In Flt</th> <th>Dual Fbk Pos</th> <th>Dual Fbk Spd</th> <th>Fbk 2 Flt</th> <th>Fbk 1 Flt</th> <th>Reset PwrUp</th> <th>MP Out Flt</th> <th>Invalid Cfg</th> <th>Critical Flt</th> <th>Combined Flt</th> </tr> </thead> <tbody> <tr> <td>Default</td> <td>0</td> <td>0</td> <td>0</td> <td>0</td> <td>0</td> <td>0</td> <td>0</td> <td>0</td> <td>0</td> <td>0</td> <td>0</td> <td>0</td> <td>0</td> <td>0</td> <td>0</td> <td>0</td> <td>0</td> <td>0</td> <td>0</td> <td>0</td> <td>0</td> <td>0</td> <td>0</td> <td>0</td> <td>0</td> <td>0</td> <td>0</td> <td>0</td> <td>0</td> <td>0</td> <td>0</td> <td>0</td> </tr> <tr> <td>Bit</td> <td>31</td> <td>30</td> <td>29</td> <td>28</td> <td>27</td> <td>26</td> <td>25</td> <td>24</td> <td>23</td> <td>22</td> <td>21</td> <td>20</td> <td>19</td> <td>18</td> <td>17</td> <td>16</td> <td>15</td> <td>14</td> <td>13</td> <td>12</td> <td>11</td> <td>10</td> <td>9</td> <td>8</td> <td>7</td> <td>6</td> <td>5</td> <td>4</td> <td>3</td> <td>2</td> <td>1</td> <td>0</td> </tr> </tbody> </table> <p>                     Bit 0 "Combined Flt" – Combined Fault Status                      Bit 1 "Critical Flt" – Critical Fault                      Bit 2 "Invalid Cfg" – Invalid Configuration Fault                      Bit 3 "MP Out Flt" – MP Out Fault                      Bit 4 "Reset PwrUp" – Reset On at PwrUp Fault                      Bit 5 "Fbk 1 Flt" – Feedback 1 Fault                      Bit 6 "Fbk 2 Flt" – Feedback 2 Fault                      Bit 7 "Dual Fbk Spd" – Dual FB Speed Fault                      Bit 8 "Dual Fbk Pos" – Dual FB Position Fault                      Bit 9 "SS In Flt" – SS_In Fault                      Bit 10 "SS Out Flt" – SS_Out Fault                      Bit 11 "Decel Flt" – Deceleration Fault                      Bit 12 "Stop Spd Flt" – Stop Speed Fault                      Bit 13 "Mov in Stop" – Motion After Stopped Fault                      Bit 14 "SLS In Flt" – SLS_In Fault                      Bit 15 "SLS Out Flt" – SLS_Out Fault                      Bit 16 "SLS Spd Flt" – SLS_Speed Fault                      Bit 17 "SMS Spd Flt" – SMS_Speed Fault                      Bit 18 "Accel Flt" – Acceleration Fault                      Bit 19 "Dir Flt" – Direction Fault                      Bit 20 "DM In Flt" – DM_In Fault                      Bit 21 "Door Mon Flt" – Door Monitoring Fault                      Bit 22 "DC Out Flt" – DC_Out Fault                      Bit 23 "LM In Flt" – LM_In Fault                      Bit 24 "Lock Mon Flt" – Lock Monitoring Fault                      Bit 25 "ESM In Flt" – ESM_In Fault                      Bit 26 "ESM Mon Flt" – ESM Monitoring Fault                      Bit 27 "Fbk 1 V Flt" – Encoder 1 Voltage Fault                      Bit 28 "Fbk 2 V Flt" – Encoder 2 Voltage Fault                 </p>		Reserved	Reserved	Reserved	Fbk 2 V Flt	Fbk 1 V Flt	ESM Mon Flt	ESM In Flt	Lock Mon Flt	LM In Flt	DC Out Flt	Door Mon Flt	DM In Flt	Dir Flt	Accel Flt	SMS Spd Flt	SLS Spd Flt	SLS Out Flt	SLS In Flt	Mov in Stop	Stop Spd Flt	Decel Flt	SS Out Flt	SS In Flt	Dual Fbk Pos	Dual Fbk Spd	Fbk 2 Flt	Fbk 1 Flt	Reset PwrUp	MP Out Flt	Invalid Cfg	Critical Flt	Combined Flt	Default	0	0	0	0	0	0	0	0	0	0	0	0	0	0	0	0	0	0	0	0	0	0	0	0	0	0	0	0	0	0	0	0	Bit	31	30	29	28	27	26	25	24	23	22	21	20	19	18	17	16	15	14	13	12	11	10	9	8	7	6	5	4	3	2	1	0
	Reserved	Reserved	Reserved	Fbk 2 V Flt	Fbk 1 V Flt	ESM Mon Flt	ESM In Flt	Lock Mon Flt	LM In Flt	DC Out Flt	Door Mon Flt	DM In Flt	Dir Flt	Accel Flt	SMS Spd Flt	SLS Spd Flt	SLS Out Flt	SLS In Flt	Mov in Stop	Stop Spd Flt	Decel Flt	SS Out Flt	SS In Flt	Dual Fbk Pos	Dual Fbk Spd	Fbk 2 Flt	Fbk 1 Flt	Reset PwrUp	MP Out Flt	Invalid Cfg	Critical Flt	Combined Flt																																																																						
Default	0	0	0	0	0	0	0	0	0	0	0	0	0	0	0	0	0	0	0	0	0	0	0	0	0	0	0	0	0	0	0	0																																																																						
Bit	31	30	29	28	27	26	25	24	23	22	21	20	19	18	17	16	15	14	13	12	11	10	9	8	7	6	5	4	3	2	1	0																																																																						

File	Group	No.	Display Name Full Name Description	Values	Read-Write	Data Type																																																																																												
Safe Speed Monitor	Faults	68	<b>Guard Status</b> Guard Status Indicates the state of the safety functions while in Run mode.		RO	32-bit Integer																																																																																												
			<p>Options</p> <table border="1"> <thead> <tr> <th>Options</th> <th>Reserved</th> <th>Reserved</th> <th>Reserved</th> <th>Stop Cmd</th> <th>SLS Cmd</th> <th>Wait No Stop</th> <th>Wait SS Cyc</th> <th>Wait Reset</th> <th>Reset In</th> <th>ESM In Prog</th> <th>ESM In</th> <th>LM In</th> <th>DM In Prog</th> <th>DM In</th> <th>DC Out</th> <th>DC Lock</th> <th>SDM In Prog</th> <th>SMA In Prog</th> <th>SMS In Prog</th> <th>SLS Out</th> <th>SLS In Prog</th> <th>SLS Req</th> <th>SLS In</th> <th>SS Out</th> <th>SS Stopped</th> <th>SS Decel</th> <th>SS In Prog</th> <th>SS Req</th> <th>SS In</th> <th>MP Out</th> <th>Config Lock</th> <th>StatusOK</th> </tr> </thead> <tbody> <tr> <td>Default</td> <td>0</td> <td>0</td> <td>0</td> <td>0</td> <td>0</td> <td>0</td> <td>0</td> <td>0</td> <td>0</td> <td>0</td> <td>0</td> <td>0</td> <td>0</td> <td>0</td> <td>0</td> <td>0</td> <td>0</td> <td>0</td> <td>0</td> <td>0</td> <td>0</td> <td>0</td> <td>0</td> <td>0</td> <td>0</td> <td>0</td> <td>0</td> <td>0</td> <td>0</td> <td>0</td> <td>0</td> </tr> <tr> <td>Bit</td> <td>31</td> <td>30</td> <td>29</td> <td>28</td> <td>27</td> <td>26</td> <td>25</td> <td>24</td> <td>23</td> <td>22</td> <td>21</td> <td>20</td> <td>19</td> <td>18</td> <td>17</td> <td>16</td> <td>15</td> <td>14</td> <td>13</td> <td>12</td> <td>11</td> <td>10</td> <td>9</td> <td>8</td> <td>7</td> <td>6</td> <td>5</td> <td>4</td> <td>3</td> <td>2</td> <td>1</td> <td>0</td> </tr> </tbody> </table> <p>Bit 0 "Status OK" – 0 = Fault; 1 = OK            Bit 1 "Config Lock" – Configuration_Lock: 0 = Unlock; 1 = Lock            Bit 2 "MP Out" – MP_Out_Value: 0 = Off; 1 = On            Bit 3 "SS In" – SS_In_Value: 0 = Off; 1 = On            Bit 4 "SS Req" – SS_Request_Status: 0 = Inactive; 1 = Active            Bit 5 "SS In Prog" – SS_In_Progress: 0 = Inactive; 1 = Active            Bit 6 "SS Decel" – SS_Decelerating_Status: 0 = Inactive; 1 = Active            Bit 7 "SS Stopped" – SS_Axis_Stopped_Status: 0 = Inactive; 1 = Active            Bit 8 "SS Out" – SS_Output_Value: 0 = Off; 1 = On            Bit 9 "SLS In" – SLS_In_Value: 0 = Off; 1 = On            Bit 10 "SLS Req" – SLS_Request_Status: 0 = Inactive; 1 = Active            Bit 11 "SLS In Prog" – SLS_In_Progress: 0 = Inactive; 1 = Active            Bit 12 "SLS Out" – SLS_Output_Value: 0 = Off; 1 = On            Bit 13 "SMS In Prog" – SMS_In_Progress: 0 = Inactive; 1 = Active            Bit 14 "SMA In Prog" – SMA_In_Progress: 0 = Inactive; 1 = Active            Bit 15 "SDM In Prog" – SDM_In_Progress: 0 = Inactive; 1 = Active            Bit 16 "DC Lock" – DC_Lock_Status: 0 = Lock; 1 = Unlock            Bit 17 "DC Out" – DC_Out_Value: 0 = Off; 1 = On            Bit 18 "DM In" – DM_In_Value: 0 = Off; 1 = On            Bit 19 "DM In Prog" – DM_In_Progress: 0 = Inactive; 1 = Active            Bit 20 "LM In" – LM_In_Value: 0 = Off; 1 = On            Bit 21 "ESM In" – ESM_In_Value: 0 = Off; 1 = On            Bit 22 "ESM In Prog" – ESM_In_Progress: 0 = Inactive; 1 = Active            Bit 23 "Reset In" – Reset_In_Value: 0 = Off; 1 = On            Bit 24 "Wait Reset" – Waiting_for_SS_Reset: 0 = Inactive; 1 = Active            Bit 25 "Wait SS Cyc" – Waiting_for_Cycle_SS_In: 0 = Inactive; 1 = Active            Bit 26 "Wait No Stop" – Waiting_for_Stop_Request_Removal: 0 = Inactive; 1 = Active            Bit 27 "SLS Cmd" – SLS_Command: 0 = Off; 1 = On            Bit 28 "Stop Cmd" – Stop_Command: 0 = Off; 1 = On</p>	Options	Reserved	Reserved	Reserved	Stop Cmd	SLS Cmd	Wait No Stop	Wait SS Cyc	Wait Reset	Reset In	ESM In Prog	ESM In	LM In	DM In Prog	DM In	DC Out	DC Lock	SDM In Prog	SMA In Prog	SMS In Prog	SLS Out	SLS In Prog	SLS Req	SLS In	SS Out	SS Stopped	SS Decel	SS In Prog	SS Req	SS In	MP Out	Config Lock	StatusOK	Default	0	0	0	0	0	0	0	0	0	0	0	0	0	0	0	0	0	0	0	0	0	0	0	0	0	0	0	0	0	0	0	Bit	31	30	29	28	27	26	25	24	23	22	21	20	19	18	17	16	15	14	13	12	11	10	9	8	7	6	5	4	3
Options	Reserved	Reserved	Reserved	Stop Cmd	SLS Cmd	Wait No Stop	Wait SS Cyc	Wait Reset	Reset In	ESM In Prog	ESM In	LM In	DM In Prog	DM In	DC Out	DC Lock	SDM In Prog	SMA In Prog	SMS In Prog	SLS Out	SLS In Prog	SLS Req	SLS In	SS Out	SS Stopped	SS Decel	SS In Prog	SS Req	SS In	MP Out	Config Lock	StatusOK																																																																		
Default	0	0	0	0	0	0	0	0	0	0	0	0	0	0	0	0	0	0	0	0	0	0	0	0	0	0	0	0	0	0	0																																																																			
Bit	31	30	29	28	27	26	25	24	23	22	21	20	19	18	17	16	15	14	13	12	11	10	9	8	7	6	5	4	3	2	1	0																																																																		

File	Group	No.	Display Name Full Name Description	Values	Read-Write	Data Type																																																																																																			
Safe Speed Monitor	Faults	69	<b>IO Diag Status</b> I/O Diagnostics Status Indicates present state of I/O used for diagnostics. <b>Important:</b> When the safety option is not in the Run mode, this parameter is not updated. Options		RO	32-bit Integer																																																																																																			
			<table border="1"> <thead> <tr> <th>Options</th> <th>Reserved</th> <th>Reserved</th> <th>Reserved</th> <th>Reserved</th> <th>Reserved</th> <th>Reserved</th> <th>Reserved</th> <th>Reserved</th> <th>Reserved</th> <th>Reserved</th> <th>MP Out Ch 1</th> <th>MP Out Ch 0</th> <th>Stop Cmd</th> <th>SLS Cmd</th> <th>Reserved</th> <th>Reset In</th> <th>LM In Ch 1</th> <th>LM In Ch 0</th> <th>DC Out Ch 1</th> <th>DC Out Ch 0</th> <th>DM In Ch 1</th> <th>DM In Ch 0</th> <th>ESM In Ch 1</th> <th>ESM In Ch 0</th> <th>SLS Out Ch 1</th> <th>SLS Out Ch 0</th> <th>SLS In Ch 1</th> <th>SLS In Ch 0</th> <th>SS Out Ch 1</th> <th>SS Out Ch 0</th> <th>SS In Ch 1</th> <th>SS In Ch 0</th> </tr> </thead> <tbody> <tr> <td>Default</td> <td>0</td> <td>0</td> <td>0</td> <td>0</td> <td>0</td> <td>0</td> <td>0</td> <td>0</td> <td>0</td> <td>0</td> <td>0</td> <td>0</td> <td>0</td> <td>0</td> <td>0</td> <td>0</td> <td>0</td> <td>0</td> <td>0</td> <td>0</td> <td>0</td> <td>0</td> <td>0</td> <td>0</td> <td>0</td> <td>0</td> <td>0</td> <td>0</td> <td>0</td> <td>0</td> <td>0</td> <td>0</td> </tr> <tr> <td>Bit</td> <td>31</td> <td>30</td> <td>29</td> <td>28</td> <td>27</td> <td>26</td> <td>25</td> <td>24</td> <td>23</td> <td>22</td> <td>21</td> <td>20</td> <td>19</td> <td>18</td> <td>17</td> <td>16</td> <td>15</td> <td>14</td> <td>13</td> <td>12</td> <td>11</td> <td>10</td> <td>9</td> <td>8</td> <td>7</td> <td>6</td> <td>5</td> <td>4</td> <td>3</td> <td>2</td> <td>1</td> <td>0</td> </tr> </tbody> </table>	Options	Reserved	Reserved	Reserved	Reserved	Reserved	Reserved	Reserved	Reserved	Reserved	Reserved	MP Out Ch 1	MP Out Ch 0	Stop Cmd	SLS Cmd	Reserved	Reset In	LM In Ch 1	LM In Ch 0	DC Out Ch 1	DC Out Ch 0	DM In Ch 1	DM In Ch 0	ESM In Ch 1	ESM In Ch 0	SLS Out Ch 1	SLS Out Ch 0	SLS In Ch 1	SLS In Ch 0	SS Out Ch 1	SS Out Ch 0	SS In Ch 1	SS In Ch 0	Default	0	0	0	0	0	0	0	0	0	0	0	0	0	0	0	0	0	0	0	0	0	0	0	0	0	0	0	0	0	0	0	0	Bit	31	30	29	28	27	26	25	24	23	22	21	20	19	18	17	16	15	14	13	12	11	10	9	8	7	6	5	4	3	2	1	0			
		Options	Reserved	Reserved	Reserved	Reserved	Reserved	Reserved	Reserved	Reserved	Reserved	Reserved	MP Out Ch 1	MP Out Ch 0	Stop Cmd	SLS Cmd	Reserved	Reset In	LM In Ch 1	LM In Ch 0	DC Out Ch 1	DC Out Ch 0	DM In Ch 1	DM In Ch 0	ESM In Ch 1	ESM In Ch 0	SLS Out Ch 1	SLS Out Ch 0	SLS In Ch 1	SLS In Ch 0	SS Out Ch 1	SS Out Ch 0	SS In Ch 1	SS In Ch 0																																																																							
		Default	0	0	0	0	0	0	0	0	0	0	0	0	0	0	0	0	0	0	0	0	0	0	0	0	0	0	0	0	0	0	0	0																																																																							
		Bit	31	30	29	28	27	26	25	24	23	22	21	20	19	18	17	16	15	14	13	12	11	10	9	8	7	6	5	4	3	2	1	0																																																																							
			Bit 0 "SS In Ch 0" – SS_in_ch_0 status Bit 1 "SS In Ch 1" – SS_in_ch_1 status Bit 2 "SS Out Ch 0" – SS_out_ch_0 status Bit 3 "SS Out Ch 1" – SS_out_ch_1 status Bit 4 "SLS In Ch 0" – SLS_in_ch_0 status Bit 5 "SLS In Ch 1" – SLS_in_ch_1 status Bit 6 "SLS Out Ch 0" – SLS_out_ch_0 status Bit 7 "SLS Out Ch 1" – SLS_out_ch_1 status Bit 8 "ESM In Ch 0" – ESM_in_ch_0 status Bit 9 "ESM In Ch 1" – ESM_in_ch_1 status Bit 10 "DM In Ch 0" – DM_in_ch_0 status Bit 11 "DM In Ch 1" – DM_in_ch_1 status Bit 12 "DC Out Ch 0" – DC_out_ch_0 status Bit 13 "DC Out Ch 1" – DC_out_ch_1 status Bit 14 "LM In Ch 0" – LM_in_ch_0 status Bit 15 "LM In Ch 1" – LM_in_ch_1 status Bit 16 "Reset In" – Reset_In status Bit 17 "Reserved" Bit 18 "SLS Cmd" – SLS_command status Bit 19 "Stop Cmd" – Stop_command status Bit 20 "MP Out Ch 0" – MP_Out_Ch_0 status Bit 21 "MP Out Ch 1" – MP_Out_Ch_1 status			0 = Open 1 = Closed																																																																																																			
		70	See <a href="#">page 300</a> .																																																																																																						
		72	See <a href="#">page 301</a> .																																																																																																						
		73	See <a href="#">page 301</a> .																																																																																																						
		74	See <a href="#">page 306</a> .																																																																																																						

## Troubleshooting

This chapter provides information to guide you through troubleshooting PowerFlex® 750-Series faults and alarms.

Topic	Page
Faults, Alarms, and Configurable Conditions	311
Drive Status Indicators	314
HIM Indication	316
Manually Clearing Faults	316
Power Layer Interface (PLI) Board 7-Segment Display	317
Setting Factory Defaults	318
System Resource Allocation	318
Hardware Service Manual	319
Integrated Motion Applications	319
Fault and Alarm Display Codes	319
Parameter Access Level	319
Drive Fault and Alarm Descriptions	320
Inverter (Port 10) Faults and Alarms (Frame 8 and Larger)	340
Converter (Port 11) Faults and Alarms (Frame 8 and Larger)	345
Precharge (Port 11) Faults and Alarms (Frame 8 and Larger)	350
N-1 and Re-Rate Functions	353
Embedded EtherNet/IP (Port 13) Events	357
I/O Faults and Alarms	359
Safe Torque Off Fault	359
Single Incremental Encoder Faults and Alarms	360
Dual Incremental Encoder Faults and Alarms	361
Universal Feedback Faults and Alarms	362
Port Verification	369
Common Symptoms and Corrective Actions	369
PowerFlex 755 Lifting/Torque Proving	372
External Brake Resistor	372
Technical Support Options	373

### Faults, Alarms, and Configurable Conditions

#### Faults

A fault identifies a condition that stops the drive. Faults are classified in two ways: Major/Minor and Auto Reset Run/Resettable/Non-Resettable/Automatic Drive Reset.

Type	Description
Major	This type of fault in an exception event that stops the drive while the drive is active. The drive goes to the Not Ready state. No faults can be present for the drive to be in the Ready state.
Minor	This type of fault is an exception event that does not stop the drive while the drive is active. To enable the drive from the Drive Not Ready state to the Ready state, the exception must no longer be present and the fault must be cleared.
Auto Reset Run (Auto Restart)	A "Y" in the "Auto Reset" column in <a href="#">Table 10</a> identifies a fault where "Auto Reset Run" (Auto Restart) can be attempted. The drive must be <b>active</b> , in a <b>running</b> state when the fault occurs. If <a href="#">P348</a> [Auto Rstrt Tries] is set to a value greater than "0," a user-configurable timer, <a href="#">P349</a> [Auto Rstrt Delay] begins. When the timer reaches zero, the drive attempts to reset the fault automatically. If the condition that caused the fault is no longer present, the fault is reset and the drive <b>is restarted</b> . This feature is also applicable to some fault types in <a href="#">Table 12</a> , <a href="#">Table 13</a> , <a href="#">Table 14</a> , and <a href="#">Table 18</a> .
Auto Clear	A "Y" in the "Auto Clear" column in <a href="#">Table 10</a> identifies a fault where "Auto Clear" can be attempted when the drive is stopped. The drive must be <b>inactive</b> , in a <b>stopped</b> state, when the fault occurs. If <a href="#">P338</a> [AutoClrFlt Tries] is set to a value greater than 0, a user-configurable timer, <a href="#">P339</a> [AutoClrFlt Delay] begins. When the timer reaches zero the drive attempts to reset the fault automatically. If the faults are successfully reset and the condition which caused the fault is no longer present then the drive is ready to run again, <b>but does not restart automatically</b> . This feature is also applicable to some fault types in <a href="#">Table 12</a> , <a href="#">Table 13</a> , <a href="#">Table 14</a> and <a href="#">Table 18</a> .
Resettable	This type of fault can be cleared. "Resettable Fault" in the "Type" column in <a href="#">Table 10</a> identifies a Resettable fault.
Non-Resettable	This type of fault normally requires drive or motor repair. The cause of the fault must be corrected before the fault can be cleared. The fault will be reset on power-up after repair. "Non-Reset Fault" in the "Type" column in <a href="#">Table 10</a> identifies a Non-Resettable fault.
Automatic Drive Reset	When this type of fault occurs, the drive resets. "Automatic Drive Reset" in the "Type" column in <a href="#">Table 10</a> identifies an Automatic Drive Reset fault.

## Alarms

An alarm identifies a condition that, if left unaddressed, can stop the drive if running or prevent the drive from starting. There are two types of alarms.

Type	Description
Alarm 1	Alarms of type 1 indicate that a condition exists. Type 1 alarms are configurable.
Alarm 2	Alarms of type 2 indicate that a configuration error exists and the drive cannot be started. Type 2 alarms are non-configurable.



## Configurable Conditions

Configurable conditions can be enabled as an alarm or fault.

Type	Description
Configurable	<p>The parameter identified in the "Configuration Parameter" column of <a href="#">Table 10</a> on page <a href="#">320</a> enables/disables the event action.</p> <p><b>Options</b></p> <p>Ignore (0) – No action is taken.</p> <p>Alarm (1) – Type 1 alarm indicated.</p> <p>Flt Minor (2) – Minor fault indicated. If running, drive continues to run. Enable with P950 [Minor Flt Cfg]. If not enabled, acts like a major fault.</p> <p>FltCoastStop (3) – Major fault indicated. Coast to Stop.</p> <p>Flt RampStop (4) – Major fault indicated. Ramp to Stop.</p> <p>Flt CL Stop (5) – Major fault indicated. Current Limit Stop.</p> <p>FltNonRest (6) – Major fault indicated. Cycle power to clear the fault.</p>

## View Faults and Alarms

Diagnostic parameters indicate fault and alarm conditions. See the [Fault/Alarm Info](#) Group that begins on [page 171](#).

To view fault history access Diagnostics and select Faults or Alarms.

## Drive Status Indicators

The condition or state of the drive is constantly monitored and is indicated through the LEDs and/or the HIM (if present).

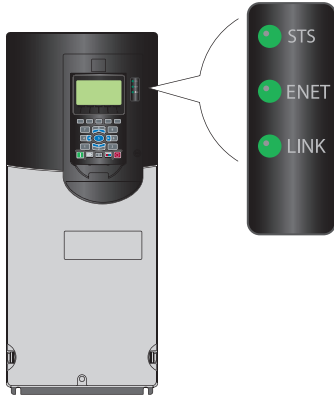
**IMPORTANT** The Status Indicator LEDs on the HIM cradle do not indicate the status of an installed Communication Adapter option. If an optional Communication Adapter is installed, refer to the option module user manual for a description of LED location and indication.

**Table 6 - PowerFlex 753 Drive Status Indicator Descriptions**

Name	Color	State	Description
STS (Status)	Green	Flashing	Drive ready but not running, and no faults are present.
		Steady	Drive running, no faults are present.
	Yellow	Flashing	Drive is not running, a start inhibit condition exists and the drive cannot be started. See parameter <a href="#">933</a> [Start Inhibits].
		Steady	A type 1 (configurable) alarm exists. A stopped drive cannot start until the alarm condition is cleared. If the drive is running, it continues to run but cannot restart until the alarm condition is cleared. See parameters <a href="#">959</a> [Alarm Status A] and <a href="#">960</a> [Alarm Status B].
	Red	Flashing	A major fault has occurred. The drive stops. Drive cannot be started until fault condition is cleared. See parameter <a href="#">951</a> [Last Fault Code].
		Steady	A non-resettable fault has occurred.
	Red / Yellow	Flashing Alternately	A minor fault has occurred. When running, the drive continues to run. System is brought to a stop under system control. Fault must be cleared to continue. Use parameter <a href="#">950</a> [Minor Flt Cfg] to enable. If not enabled, acts like a major fault.
	Yellow / Green	Flashing Alternately	When running, a type 1 alarm exists. See parameters <a href="#">959</a> [Alarm Status A] and <a href="#">960</a> [Alarm Status B].
Green / Red	Flashing Alternately	Drive is flash updating.	



**Table 7 - PowerFlex 755 Drive Status Indicator Descriptions**



Name	Color	State	Description
STS (Status)	Green	Flashing	Drive ready but not running, and no faults are present.
		Steady	Drive running, no faults are present.
	Yellow	Flashing	Drive is not running, a type 2 (non-configurable) alarm condition exists and the drive cannot be started. See parameter <a href="#">961</a> [Type 2 Alarms].
		Steady	A type 1 (configurable) alarm exists. A stopped drive cannot start until the alarm condition is cleared. If the drive is running, it continues to run but cannot restart until the alarm condition is cleared. See parameters <a href="#">959</a> [Alarm Status A] and <a href="#">960</a> [Alarm Status B].
	Red	Flashing	A major fault has occurred. The drive stops. The drive cannot start until the fault condition is cleared. See parameter <a href="#">951</a> [Last Fault Code].
		Steady	A non-resettable fault has occurred.
	Red / Yellow	Flashing Alternately	A minor fault has occurred. A running drive continues to run. System is brought to a stop under system control. Fault must be cleared to continue. Use parameter <a href="#">950</a> [Minor Flt Cfg] to enable. If not enabled, acts like a major fault.
	Yellow / Green	Flashing Alternately	When running, a type 1 alarm exists. See parameters <a href="#">959</a> [Alarm Status A] and <a href="#">960</a> [Alarm Status B].
Green / Red	Flashing Alternately	Drive is flash updating.	
ENET	Unlit	Off	Embedded EtherNet/IP is not properly connected to the network or needs an IP address.
	Red	Flashing	An EtherNet/IP connection has timed out.
		Steady	Adapter failed the duplicate IP address detection test.
	Red / Green	Flashing Alternately	Adapter is performing a self-test.
	Green	Flashing	Adapter is properly connected but is not communicating with any devices on the network.
Steady		Adapter is properly connected and communicating on the network.	
LINK	Unlit	Off	Adapter is not powered or is not transmitting on the network.
	Green	Flashing	Adapter is properly connected and transmitting data packets on the network.
		Steady	Adapter is properly connected but is not transmitting on the network.

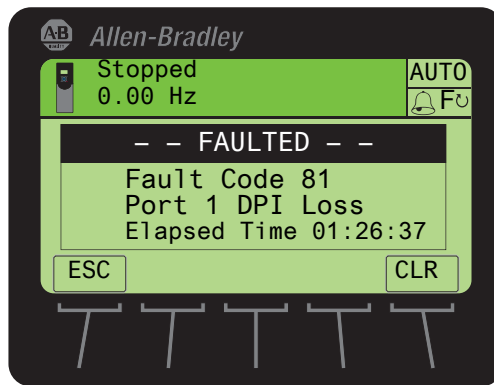
## HIM Indication

## Fault Display Screen

The pop-up Fault Display screen automatically appears when a fault condition for the Host Drive or any connected peripheral is detected. The pop-up Fault Display screen flashes to alert that a fault condition exists. This screen displays the:

- Fault Code number (See [Fault and Alarm Display Codes on page 319.](#))
- Fault description
- Elapsed time (in hh:mm:ss format) from fault detection


**Figure 3 - Pop-Up/Flashing Fault Display Screen**





### Soft Key Functions

Label	Name	Description
ESC	Escape	Reverts to the previous screen without clearing the fault.
CLR	Clear	Removes the pop-up Fault Display screen from the display and clears the fault.

### Single Function Key

Key	Name	Description
	Stop	Removes the pop-up Fault Display screen from the display and clears the fault.

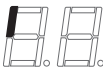
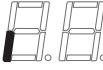







## Manually Clearing Faults

Step	Key
1. To acknowledge the fault, press the "Clear" soft key. The fault information is removed so that you can use the HIM.	
2. Address the condition that caused the fault. The cause must be corrected before the fault can be cleared.	
3. After corrective action has been taken, clear the fault by one of these methods: Press Stop (if running the drive stops) Cycle drive power Select the "Clear" soft key on the HIM Diagnostic folder Faults menu.	


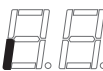
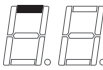
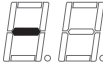
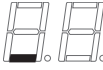

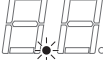
## Power Layer Interface (PLI) Board 7-Segment Display

PowerFlex 755 Frame 8 and larger drives provide a pair of 7-segment displays to indicate drive status and conditions.

### Series A Display

Lit Segment	Indication	Description
	Fault Clear	Indicates that a fault condition has been cleared.
	Fault	Indicates that a fault condition exists.
	Power On	Indicates that power is applied to the PLI board.
	Charged	Indicates the state of the pre-charge pin.
	PWM Enable	IGBT gating is enabled. When disabled, all IGBT signal inputs to the PLI IGBT driver chip are low. IGBT gating is enabled by setting bit 0 of the Config Register. IGBT gating is disabled by clearing bit 0 or by "POE" fault (IOC, Bus Overvoltage, or Ground Fault).
	Fiber Loss Fault	Turns on when a Fiber Loss fault occurs. A Fiber Loss fault occurs when the LOS signal is high or when a valid data packet has not been received for 1024 μs. The fault is latched and is cleared by setting bit 8 of the Config Register. The Fiber Loss fault inhibits IGBT firing in the same manner as a "POE" fault.
	Fiber Loss Pin	Indicates that the actual state of the LOS pin described in Write Enable.
	SAFE Vcc Power On	Power is applied to the PLI IGBT driver chip (U14). Delayed for 12 seconds after power-up.
	Write Enable	Data writes from the fiber-optic link are enabled to PLI registers. Data writes are disabled for ten seconds (time that is required for the Control Board to initialize) after negation of the LOS pin of the PLI fiber-optic transceiver. LOS is driven high when the optical power into the fiber-optic receiver is too low (broken, crimped, disconnected fiber, or transmitter at opposite end of fiber is not operating).

### Series B Display

Lit Segment	Indication	Description
	PWM Enable	IGBT gating is enabled. IGBT gating is enabled by setting bit 0 of the Config Register. IGBT gating is disabled by clearing bit 0 or by fault.
	Fault	Indicates that a fault condition exists.
	Initialization Done	Indicates that the control has initialized the PLI board.
	Fiber Loss	Actual state of the LOS pin. LOS is driven high when the optical power into the fiber-optic receiver is too low (broken, crimped, disconnected fiber, or transmitter at opposite end of fiber is not operating).
	On Line	The PLI is powered.
	System Safety Enable B	Pin 1 of the 541 PLI IGBT driver chip (U14) is low. This pin must be low to fire the IGBTs.
	Aux Power	A 24V auxiliary supply provide power for the PLI board.

## Setting Factory Defaults

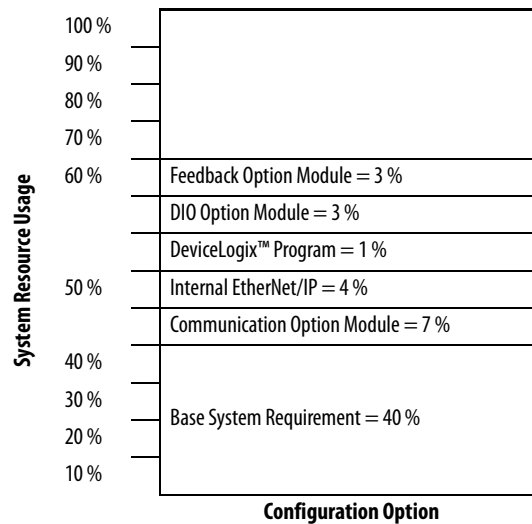
The PowerFlex 20-HIM-A6 / -C6S HIM User Manual, publication [20HIM-UM001](#), provides detailed Human Interface Module (HIM) use instructions and explains the HIM capabilities, including setting PowerFlex 750-Series drive to factory settings.

The following parameters are not reset when Set Defaults “Most” is executed: P300 [Speed Units], P301 [Access Level], P302 [Language], P305 [Voltage Class], P306 [Duty Rating], P471 [PredMaint Rst En], and P472 [PredMaint Reset].

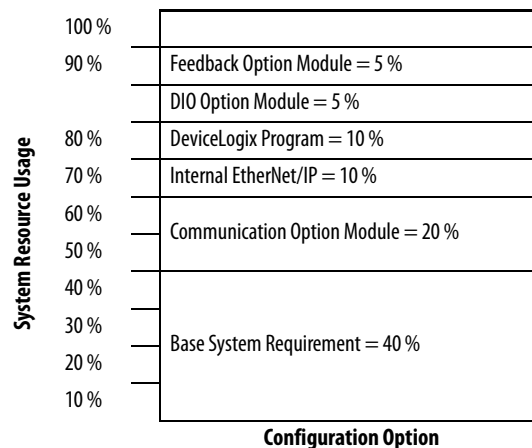
## System Resource Allocation

Each option that is installed in the drive requires a percentage of the available system resources. Some options configurations can exceed the available resources of the main control board processor. If 90 % of the available system resources is reached, an F19 Task Overrun alarm results, which indicates that system resource utilization is excessive.

**Table 8 - System Resource Allocation - Drive Frames 1...7**



**Table 9 - System Resource Allocation - Drive Frames 8...10**



## Hardware Service Manual

The PowerFlex 750-Series AC Drive Hardware Service Manual, publication [750-TG001](#), provides schematics and detailed instructions on part replacement for Frame 8 drives and larger.

## Integrated Motion Applications

When a PowerFlex 755 is used in Integrated Motion on EtherNet/IP mode, the Logix controller and RSLogix 5000® are the exclusive owners of the drive (same as Kinetix®). An HIM or drive software, such as DriveExplorer™ and DriveExecutive™, cannot be used to control the drive or change configuration settings. These tools can only be used for monitoring.

## Fault and Alarm Display Codes

Event numbers for PowerFlex 750-Series faults and alarms are displayed in one of three formats.

- Port 00 (Host Drive) displays the event number only. For example, Fault 3 “Power Loss” is displayed as:  
**Fault Code 3.**
- Ports 01...09 use the format PEEE, which identifies the port number (P) and event number (EEE). For example, Fault 1 “Analog In Loss” on an I/O module that is installed in Port 4 is displayed as:  
**Fault Code 4001.**
- Ports 10...14 use the format PPEEE, which identifies the port number (PP) and event number (EEE). For example, Fault 37 “Net IO Timeout” on Port 14 is displayed as:  
**Fault Code 14037.**

## Parameter Access Level

Three parameter access level options are selectable by P301 [Access Level].

- Option 0 “Basic” is the most limited view that only displays commonly used parameters and options.
- Option 1 “Advanced” is an expanded view that can be required to access more advanced drive features.
- Option 2 “Expert” provides a comprehensive view of the entire drive parameter set.

If a parameter is not displaying, you may need to select the “Advanced” or “Expert” view to make that parameter visible in the list.

## Drive Fault and Alarm Descriptions

Table 10 contains a list of drive-specific faults and alarms and includes the following information:

- The fault or alarm type
- The action that is taken when the drive faults
- The parameter that is used to configure the fault or alarm (if applicable)
- A description and action (where applicable)
- See [Faults, Alarms, and Configurable Conditions](#) for information on the Auto Reset (Auto Reset Run/Restart) and Auto Clear (Auto Reset Clear) columns in this table.
- The Emerg Prot OVRD column shows the bit in P1683 [Emerg Prot OVRD], if applicable, related to the fault. See [P1683](#) for the related events overridden by the function when the bit is set.


The faults and alarms that are listed in [Table 10](#) only apply to non-Integrated Motion applications. See [Table 39](#) on page [543](#) for a list of Integrated Motion faults.

**Table 10 - Drive Fault and Alarm Types, Descriptions, and Actions**

Event No.	Fault/Alarm Text	Type	Fault Action	Configuration Parameter	Auto Reset	Auto Clear	Emerg Prot OVRD	Description/Actions
0	No Entry							
2	Auxiliary Input	Resettable Fault	Coast	<a href="#">157</a> [DI Aux Fault]	Y	Y	Bit 5 "PERIF Flts"	An auxiliary input interlock is open. A condition within the application is not allowing the drive to energize the motor and the digital input that is assigned in P157 [DI Aux Fault] has forced this fault.
3	Power Loss	Configurable		<a href="#">449</a> [Power Loss Actn]	Y	Y	Bit 1 "Line Faults"	The DC bus voltage remained below the [Pwr Loss <i>n</i> Level] of nominal for longer than the time programmed in [Pwr Loss <i>n</i> Time].
4	UnderVoltage	Configurable		<a href="#">460</a> [UnderVltg Action]	Y	Y	Bit 1 "Line Faults"	If the bus voltage indicated in P11 [DC Bus Volts] falls below the value set in P461 [UnderVltg Level] an undervoltage condition exists.
5	OverVoltage	Resettable Fault	Coast		Y	Y	Bit 1 "Line Faults"	The DC bus voltage exceeded the maximum value. See P11 [DC Bus Volts].
7	Motor Overload	Configurable		<a href="#">410</a> [Motor OL Actn]	Y	Y	Bit 0 "Load Faults"	An internal electronic overload trip has occurred. See P7 [Output Current], P26 [Motor NP Amps, P413 [Mtr OL Factor], and/or P414 [Mtr OL Hertz].
8	Heatsink OvrTemp	Resettable Fault	Coast		Y	Y	Bit 2 "PwrStrucFlts"	The heatsink temperature has exceeded 100 % of the drive temperature. Heatsink over temperature occurs between 115...120 °C. The exact value is stored in drive firmware. See P943 [Drive Temp Pct] and/or P944 [Drive Temp C].
9	Trnsistr OvrTemp	Resettable Fault	Coast		Y	Y		The output transistors have exceeded the maximum operating temperature. See P941 [IGBT Temp Pct] and/or P942 [IGBT Temp C]. If using the drive on a chiller plate, P38 [PWM Frequency] must be set to 2 kHz.
10	DynBrake OvrTemp	Alarm 1						The dynamic brake resistor has exceeded its maximum operating temperature. Check settings of parameters P382 [DB Resistor Type] through P385 [DB ExtPulseWatts].



Event No.	Fault/Alarm Text	Type	Fault Action	Configuration Parameter	Auto Reset	Auto Clear	Emerg Prot OVRD	Description/Actions
12	HW OverCurrent	Resettable Fault	Coast		Y	Y	Bit 0 "Load Faults"	The drive output current has exceeded the hardware current limit. Check the motor and external wiring to the drive output terminals for a grounded condition. Check the programming. Check for excess load, and other causes of excess current. Insulation Resistance (IR) test the wiring to motor.
13	Ground Fault	Resettable Fault	Coast		Y	Y	Bit 0 "Load Faults"	A current path to earth ground greater than 25 % of drive rating has occurred. Check the motor and external wiring to the drive output terminals for a grounded condition. Check the programming. Check for excess load, and other causes of excess current. Insulation Resistance (IR) test the wiring to motor.
14	Ground Warning	Configurable		<a href="#">466</a> [Ground Warn Actn]			Bit 0 "Load Faults"	The ground current has exceeded the level set in P467 [Ground Warn Lvl].
15	Load Loss	Configurable		<a href="#">441</a> [Load Loss Action]			Bit 0 "Load Faults"	The output torque current is below the value programmed in P442 [Load Loss Level] for a time period greater than the time programmed in P443 [Load Loss Time].
17	Input Phase Loss	Configurable		<a href="#">462</a> [InPhase LossActn]			Bit 1 "Line Faults"	The DC bus ripple has exceeded a preset level. Make these checks and adjustments in this order. <ul style="list-style-type: none"> <li>• Check input impedance balance.</li> <li>• Increase the setting of P463 [InPhase Loss Lvl] to make the drive less sensitive.</li> <li>• Tune the bus regulator or speed regulator to mitigate the effects of dynamic cyclic loads on DC bus ripple.</li> <li>• Disable the fault by setting P462 [InPhase LossActn] to 0 "Ignore" and use an external phase loss detector such as a Bulletin 809S relay.</li> </ul>
18	Motor PTC Trip	Configurable		<a href="#">250</a> [PTC Cfg]			Bit 8 "Board Faults"	Motor PTC (Positive Temperature Coefficient) over temperature.
19	Task Overrun	Alarm 1						System resource utilization is at or above 90 % of capacity. Review the system resource allocation table on <a href="#">page 318</a> .
20	TorqPrv Spd Band	Resettable Fault	Coast				Bit 10 "TorqPrv Flts"	The difference between P2 [Commanded SpdRef] and P3 [Mtr Vel Fdbk] has exceeded the level programmed in P1105 [Speed Dev Band] for a time period greater than the time programmed in P1106 [SpdBand Intgrtr].

Event No.	Fault/Alarm Text	Type	Fault Action	Configuration Parameter	Auto Reset	Auto Clear	Emerg Prot OVRD	Description/Actions
21	Output PhaseLoss	Configurable		<a href="#">444</a> [OutPhaseLossActn]			Bit 0 "Load Faults"	<p>The current in one or more phases has been lost or remains below the threshold set in P445 [OutPhaseLossLvl] for 1 second. Decreasing the threshold makes the drive less sensitive to tripping. A decreased threshold is necessary when the motor is smaller than the drive rating.</p> <p>If TorqProve™ is active, the current in one or more phases has been lost or remains below a threshold for five msec. The phases are checked at start to be sure that torque is delivered to the load. If the drive is faulting on start, increase P44 [Flux Up Time].</p> <p>If TorqProve is active, and the brake is slipping, this fault occurs. When TorqProve is used, before the signal to the brake is applied to release it, the flux up time is used to check the three phases. The angle is adjusted to be sure that current is flowing through all three phases. If the motor moves during this test, the brake is not holding and a phase loss can occur. If TorqProve is active, and no brake is present, this fault occurs. Check for an open output contactor.</p> <hr/> <div style="display: flex; align-items: center;">  <p><b>ATTENTION:</b> If a PM motor is used and motor phase is lost, lower P445 [OutPhaseLossLvl] to 0 if TorqProve is not used or the drive output (motor) contacts are not used. Otherwise, lower P445 [OutPhaseLossLvl] until the drive is able to start and run without faulting.</p> </div> <hr/>
24	Decel Inhibit	Configurable		<a href="#">409</a> [Dec Inhibit Actn]			Bit 0 "Load Faults"	<p>The drive is not following a commanded deceleration because it is attempting to limit the bus voltage.</p> <p>For high inertia loads, set P621 [Slip RPM at FLA] to 0 (V/Hz and SVC modes only).</p>
25	OverSpeed Limit	Resettable Fault	Coast		Y	Y	Bit 0 "Load Faults"	<p>The motor operating speed exceeds the limit set by the maximum speed setting P524 [Overspeed Limit]. For forward motor rotation, this limit is P520 [Max Fwd Speed] + P524 [Overspeed Limit]. For reverse motor rotation, this limit is P521 [Max Rev Speed] - P524 [Overspeed Limit]. When flux vector control modes are selected in P35 [Motor Ctrl Mode], P131 [Active Vel Fdbk] determines the motor operating speed. For all other non-flux vector control modes, P1 [Output Frequency] determines the motor operating speed.</p>
26	Brake Slipped	Alarm 1						<p>The encoder movement has exceeded the level in P1110 [Brk Slip Count] after the brake was set and the brake slip maneuver is controlling the drive. (Drive is active.) Cycle power to the drive to reset.</p>
		Alarm 2						<p>The encoder movement has exceeded the level in P1110 [Brk Slip Count] after the brake was set and the brake slip maneuver is finished. (Drive is stopped.) Cycle power to the drive to reset.</p>

Event No.	Fault/Alarm Text	Type	Fault Action	Configuration Parameter	Auto Reset	Auto Clear	Emerg Prot OVRD	Description/Actions
27	Torq Prove Cflct	Alarm 2						<p>When P1100 [Trq Prove Cfg] is enabled, these parameters must be properly configured:</p> <ul style="list-style-type: none"> <li>• P35 [Motor Ctrl Mode]</li> <li>• P125 [Pri Vel Fdbk Sel] and P135 [Mtr Psn Fdbk Sel] must be set to a valid feedback device. The feedback device does not have to be the same device. However, Open Loop and Simulation Feedback are not considered valid feedback devices.</li> </ul> <p>If parameters 125 and 135 are set to a feedback module, verify that the module parameters are set properly. On the module, the feedback loss action CANNOT be set to 0 "Ignore." Does not work in PM FV mode. Does not work with single ended or channel A only encoders.</p>
28	TP Encls Config	Alarm 2						Encoderless TorqProve has been enabled but the application concerns of encoderless operation have not read and understood. Read the "Attention" on <a href="#">page 372</a> relating to the use of TorqProve with no encoder.
29	Analog In Loss	Configurable		<a href="#">263</a> [Anlg In0 LssActn]			Bit 8 "Board Faults"	Analog input has a lost signal.
30	Relay0 Life	Configurable		<a href="#">292</a> [R00 LifeEvtActn]			Bit 8 "Board Faults"	Predictive maintenance.
33	AuRsts Exhausted	Resettable Fault	Coast	<a href="#">348</a> [Auto Rstrt Tries]			Bit 8 "Board Faults"	The drive attempted to reset a fault and resume running for the programmed number of tries, unsuccessfully.
34	AutClrFltExhaust	Resettable Fault	Coast	<a href="#">338</a> [AutoClrFlt Tries]			Bit 8 "Board Faults"	<p>Auto Clear Faults Exhausted</p> <p>This fault indicates when the running Auto clear faults retry value has exceeded parameter 338 [AutoClrFlt Tries], provided bit 1 in parameter 347 [Auto Retry Fault] is set.</p>
35	IPM OverCurrent	Resettable Fault	Coast		Y	Y	Bit 0 "Load Faults"	The current magnitude has exceeded the trip level set by P1640 [IPM Max Cur]. Set this value to 0 only when the drive is set to the V/Hz or SVC mode.
36	SW OverCurrent	Resettable Fault	Coast		Y	Y	Bit 0 "Load Faults"	The drive output current has exceeded the 1 ms current rating. This rating is greater than the 3 second current rating and less than the hardware overcurrent fault level. It is typically 200...250% of the drive continuous rating.
38 39 40	Phase U to Grnd Phase V to Grnd Phase W to Grnd	Resettable Fault	Coast				Bit 0 "Load Faults"	<p>A phase to ground fault has been detected between the drive and motor in this phase.</p> <p>Rotate U/T1, V/T2, W/T3 connections.</p> <ul style="list-style-type: none"> <li>• If the problem follows the wire, suspect a field wiring problem.</li> <li>• If no change, suspect a problem with the drive.</li> </ul>
41 42 43	Phase UV Short Phase VW Short Phase WU Short	Resettable Fault	Coast				Bit 0 "Load Faults"	<p>Excessive current has been detected between these two output terminals.</p> <p>Rotate U/T1, V/T2, W/T3 connections.</p> <ul style="list-style-type: none"> <li>• If the problem follows the wire, suspect a field wiring problem.</li> <li>• If no change, suspect a problem with the drive.</li> </ul>
44 45 46	Phase UNegToGrnd Phase VNegToGrnd Phase WNegToGrnd	Resettable Fault	Coast				Bit 0 "Load Faults"	<p>A phase to ground fault has been detected between the drive and motor in this phase.</p> <p>Rotate U/T1, V/T2, W/T3 connections.</p> <ul style="list-style-type: none"> <li>• If the problem follows the wire, suspect a field wiring problem.</li> <li>• If no change, suspect a problem with the drive.</li> </ul>
48	System Defaulted	Resettable Fault	Coast				Bit 8 "Board Faults"	The drive was commanded to write default values.
49	Drive Powerup	–						A Power Up Marker in the Fault Queue indicating that the drive power cycled.
51	Clr Fault Queue	–						Indication that the fault queue has been cleared.

Event No.	Fault/Alarm Text	Type	Fault Action	Configuration Parameter	Auto Reset	Auto Clear	Emerg Prot OVRD	Description/Actions
55	Ctrl Bd Overtemp	Resettable Fault	Coast				Bit 8 "Board Faults"	The temperature sensor on the main control board detected excessive heat. See product temperature requirement.
58	Module Defaulted	Resettable Fault	Coast				Bit 8 "Board Faults"	The module was commanded to write default values.
59	Invalid Code	Resettable Fault	Coast				Bit 8 "Board Faults"	Internal error.
61	Shear Pin 1	Configurable		<a href="#">435</a> [Shear Pin 1 Actn]	Y	Y	Bit 0 "Load Faults"	The programmed value in P436 [Shear Pin1 Level] has been exceeded.
62	Shear Pin 2	Configurable		<a href="#">438</a> [Shear Pin 2 Actn]	Y	Y	Bit 0 "Load Faults"	The programmed value in P439 [Shear Pin2 Level] has been exceeded.
64	Drive OverLoad	Alarm 1						P940 [Drive OL Count] has exceeded 50 % but is less than 100 %.
		Resettable Fault	Coast		Y	Y	Bit 2 "PwrStrucFlts"	P940 [Drive OL Count] has exceeded 100 %. Reduce the mechanical load on the drive. Inverter fiber-optic connection is not detected on Frame 8 drive. This fault can occur on power-up if the control detects that no inverter is detected via the fiber-optic communication on a Frame 8 drive.
66	OW Torq Level	Alarm 1		<a href="#">1172</a> [TorqAlarm Level]				Oil Well Torque Level If the Torque goes above P1172 [TorqAlarm Level] then the alarm condition exists.
67	Pump Off	Alarm 1						Pump Off condition has been detected.
68	OW Torq Level Lo	Alarm 1		<a href="#">1185</a> [TorqAlarm LoLvl]				Oil Well Torque Level Low If the Torque goes below P1185 [TorqAlarm LoLvl] then the alarm condition exists.
71	Port 1 Adapter	Resettable Fault	Coast				Bit 11 "Port1-3 Flts"	The DPI™ communications option has a fault. See device event queue.
72	Port 2 Adapter			Bit 11 "Port1-3 Flts"				
73	Port 3 Adapter			Bit 11 "Port1-3 Flts"				
74	Port 4 Adapter			Bit 12 "Port 4 Flts"				
75	Port 5 Adapter			Bit 13 "Port 5 Flts"				
76	Port 6 Adapter			Bit14 "Port 6 Flts"				
77	IR Volts Range	Alarm 2						The value for P73 [IR Voltage Drop], which is calculated from the motor nameplate data, is not within the range of acceptable values, as determined by the Calculated Autotune procedure. Check the motor nameplate data against parameters P25 [Motor NP Volts] through P30 [Motor NP Power].
		Resettable Fault	Coast				Bit 8 "Board Faults"	The measured value for P73 [IR Voltage Drop] is not within the range of acceptable values, as determined by the Static or Rotate Autotune procedure.
78	FluxAmpsRef Rang	Alarm 2						The value for flux amps exceeds the value programmed in P26 [Motor NP Amps], as calculated by the Autotune procedure. Check motor nameplate data against parameters P25 [Motor NP Volts] through P30 [Motor NP Power].
		Resettable Fault	Coast				Bit 8 "Board Faults"	The value for flux amps exceeds the value programmed in P26 [Motor NP Amps], as measured by the Static or Rotate Autotune procedure.

Event No.	Fault/Alarm Text	Type	Fault Action	Configuration Parameter	Auto Reset	Auto Clear	Emerg Prot OVRD	Description/Actions
79	Excessive Load	Resettable Fault	Coast				Bit 8 "Board Faults"	The motor did not come up to speed in the allotted time during Autotune.
80	AutoTune Aborted	Resettable Fault	Coast				Bit 8 "Board Faults"	The Autotune function was manually canceled or a fault occurred.
81	Port 1 DPI Loss	Resettable Fault	Coast	324 [Logic Mask]			Bit 11 "Port1-3 Flts"	The DPI port stopped communicating. Check connections and drive grounding.
82	Port 2 DPI Loss							
83	Port 3 DPI Loss							
84	Port 4 DPI Loss							
85	Port 5 DPI Loss							
86	Port 6 DPI Loss							
87	IXo VoltageRange	Alarm 2						The default for P70 [Autotune] is 1 "Calculate" and the voltage that is calculated for motor inductive impedance exceeds 25 % of the value of P25 [Motor NP Volts].
		Resettable Fault	Coast				Bit 8 "Board Faults"	P70 [Autotune] is set to 2 "Static Tune" or 3 "Rotate Tune" and the voltage that is measured for motor inductive impedance exceeds 25 % of the value of P25 [Motor NP Volts].
91	Pri VelFdbk Loss	Configurable		Note: See option module for configuration parameter number			Bit 9 "Fdbk Faults"	A Feedback Loss has been detected for the source of P127 [Pri Vel Feedback]. The feedback loss could be due to a problem detected by the feedback option module selected by P125 [Pri Vel Fdbk Sel] or due to a loss in communication between the feedback option module and main control board. The source of primary velocity feedback must be configured not to fault if the feedback loss switchover feature is used.
93	Hw Enable Check	Resettable Fault	Coast				Bit 8 "Board Faults"	The hardware enable is disabled (a jumper is installed) but indicates not enabled.
94	Alt VelFdbk Loss	Configurable		Note: See option module for configuration parameter number			Bit 9 "Fdbk Faults"	A Feedback Loss has been detected for the source of P128 [Alt Vel Fdbk Sel]. The feedback loss could be due to a problem detected by the feedback option module selected by P128 [Alt Vel Fdbk Sel], or due to a loss in communication between the feedback option module and main control board.
95	Aux VelFdbk Loss	Configurable		Note: See option module for configuration parameter number			Bit 9 "Fdbk Faults"	A Feedback Loss has been detected for the source of P132 [Aux Vel Fdbk Sel]. The feedback loss could be due to a problem detected by the feedback option module selected by P132 [Aux Vel Fdbk Sel], or due to a loss in communication between the feedback option module and main control board.
96	PositionFdbkLoss	Configurable		Note: See option module for configuration parameter number			Bit 9 "Fdbk Faults"	A Feedback Loss has been detected for the source of P847 [Psn Fdbk]. The feedback loss could be due to a problem detected by the feedback option module selected by P135 [Mtr Psn Fdbk Sel], or due to a loss in communication between the feedback option module and main control board.
97	Auto Tach Switch	Resettable Fault	Coast	635 [Spd Options Ctrl] Bit 7 "Auto Tach SW"			Bit 9 "Fdbk Faults"	Indication that either of the two following conditions exists. <ul style="list-style-type: none"> <li>Tach switch has occurred and alternate feedback device has failed.</li> <li>Tach switch has not occurred, Auto Tach Switch Option is enabled and both primary and alternate devices have failed.</li> </ul>
100	Parameter Chksum	Resettable Fault	Coast				Bit 8 "Board Faults"	The checksum read from the non-volatile storage does not match the checksum calculated. The data is set to the default value.

Event No.	Fault/Alarm Text	Type	Fault Action	Configuration Parameter	Auto Reset	Auto Clear	Emerg Prot OVRD	Description/Actions
101	PwrDn NVS Blank	Resettable Fault	Coast				Bit 8 "Board Faults"	Internal data error. <ul style="list-style-type: none"> <li>Reset parameter defaults. See publication <a href="#">20HIM-UM001</a> for instructions.</li> <li>Reload parameters.</li> <li>If problem persists, replace main control board.</li> </ul> Fault normally occurs after a flash update to correct F117 fault.
102	NVS Not Blank	Resettable Fault	Coast				Bit 8 "Board Faults"	Internal data error.
103	PwrDn NVS Incomp	Resettable Fault	Coast				Bit 8 "Board Faults"	Internal data error.
104	Pwr Brd Checksum	Non-Reset Fault						The checksum read from the non-volatile storage does not match the checksum calculated. The data is set to the default value.
106	Incompat MCB-PB	Non-Reset Fault	Coast					The main control board did not recognize the power structure. Flash with newer Application revision.
107	Replaced MCB-PB	Resettable Fault	Coast				Bit 8 "Board Faults"	The main control board was moved to another power structure. The data is set to the default values.
108	Anlg Cal Chksum	Non-Reset Fault	Coast					The checksum read from the analog calibration data does not match the checksum calculated. Replace main control board.
110	Ivld Pwr Bd Data	Non-Reset Fault	Coast					Power structure data invalid. <ul style="list-style-type: none"> <li>Verify ribbon cable connection between the main control board and the power interface board.</li> <li>Replace power interface board.</li> </ul>
111	PwrBd Invalid ID	Non-Reset Fault	Coast					Power structure ID invalid. <ul style="list-style-type: none"> <li>Verify ribbon cable connection between the main control board and the power interface board.</li> <li>Replace power interface board.</li> </ul>
112	PwrBd App MinVer	Resettable Fault	Coast				Bit 8 "Board Faults"	Power structure needs newer Application revision. Flash with newer Application revision.
113	Tracking DataErr	Resettable Fault	Coast				Bit 8 "Board Faults"	Internal data error.
115	PwrDn Table Full	Resettable Fault	Coast				Bit 8 "Board Faults"	Internal data error.
116	PwrDnEntry2Large	Resettable Fault	Coast				Bit 8 "Board Faults"	Internal data error.
117	PwrDn Data Chksm	Resettable Fault	Coast				Bit 8 "Board Faults"	Internal data error.
118	PwrBd PwrDn Chks	Resettable Fault	Coast				Bit 8 "Board Faults"	Internal data error.
124	App ID Changed	Resettable Fault	Coast				Bit 8 "Board Faults"	Application Firmware changed. Verify Application revision.
125	Using Backup App	Resettable Fault	Coast				Bit 8 "Board Faults"	Application did not flash correctly. Reflash.
134	Start On PowerUp	Alarm 1						When P345 [Start At PowerUp] is enabled, an alarm is set for the time programmed in P346 [PowerUp Delay].
137	Ext Prechrg Err	Configurable		<a href="#">323</a> [Prchrg Err Cfg]			Bit 1 "Line Faults"	The seal contact on the external precharge contactor has opened (as signaled by P190 [DI Prchrg Seal]) while the drive was running (PWM was active).
138	Precharge Open	Resettable Fault	Coast	<a href="#">321</a> [Prchrg Control] <a href="#">190</a> [DI Prchrg Seal] <a href="#">189</a> [DI Precharge]	Y	Y	Bit 1 "Line Faults"	The internal precharge was commanded to open while the drive was running (PWM was active). The internal fault latch is automatically cleared when PWM is disabled.
141	Autn Enc Angle	Resettable Fault	Coast				Bit 8 "Board Faults"	P78 [EncdrLss AngComp] is out of range.

Event No.	Fault/Alarm Text	Type	Fault Action	Configuration Parameter	Auto Reset	Auto Clear	Emerg Prot OVRD	Description/Actions
142	Autn Spd Rstrct	Resettable Fault	Coast				Bit 8 "Board Faults"	Frequency limit settings are preventing the drive from reaching a suitable speed during an Inertia Tune test.
143	Autotune CurReg	Resettable Fault	Coast				Bit 8 "Board Faults"	Calculated values for P96 [VCL Cur Reg Kp] and/or P97 [VCL Cur Reg Ki] are out of range.
144	Autotune Inertia	Resettable Fault	Coast				Bit 8 "Board Faults"	Results from the Inertia Tune test out of range for P76 [Total Inertia].
145	Autotune Travel	Resettable Fault	Coast				Bit 8 "Board Faults"	When P77 [Inertia Test Lmt] is set, the Inertia Tune test was prevented from reaching a suitable speed to run the test.
152	No Stop Source	Resettable Fault	Coast				Bit 5 "PERIF Flts"	Last stop source has been removed.
155	Bipolar Conflict	Alarm 2						P308 [Direction Mode] is set to 1 "Bipolar" or 2 "Rev Disable" and one or more digital inputs is enabled for direction control.





Event No.	Fault/Alarm Text	Type	Fault Action	Configuration Parameter	Auto Reset	Auto Clear	Emerg Prot OVRD	Description/Actions																																																																																																																																																																																																																																																																																																																																																																																																																																																																																																																																																																																																																																																																																																				
158	DigIn Cfg C	Alarm 2						Digital input conflict. Input functions that cannot be assigned to the same digital input have been selected (for example run and stop). Correct Digital Input configuration.																																																																																																																																																																																																																																																																																																																																																																																																																																																																																																																																																																																																																																																																																																				
Digital Input combinations marked “●” cause an alarm.																																																																																																																																																																																																																																																																																																																																																																																																																																																																																																																																																																																																																																																																																																												
								<table border="1" style="width: 100%; border-collapse: collapse; text-align: center;"> <thead> <tr> <th></th> <th>DI Stop Mode B</th> <th>DI Speed Sel 2</th> <th>DI Speed Sel 1</th> <th>DI Speed Sel 0</th> <th>DI Manual Ctrl</th> <th>DI Decel 2</th> <th>DI Accel 2</th> <th>DI Fwd Reverse<sup>(1)</sup></th> <th>DI Emergency OvrRide</th> <th>DI Jog 2 Reverse<sup>(1)</sup></th> <th>DI Jog 2 Forward<sup>(1)</sup></th> <th>DI Jog 2</th> <th>DI Jog 1 Reverse<sup>(1)</sup></th> <th>DI Jog 1 Forward<sup>(1)</sup></th> <th>DI Jog 1</th> <th>DI Run Reverse<sup>(1)</sup></th> <th>DI Run Forward<sup>(1)</sup></th> <th>DI Run</th> <th>DI Start</th> <th>DI HOA Start</th> <th>DI Clear Fault</th> <th>DI Aux Fault</th> <th>DI Cur Lmt Stop</th> <th>DI Coast Stop</th> <th>DI Stop</th> </tr> </thead> <tbody> <tr><td>DI Stop</td><td>●</td><td>●</td><td>●</td><td>●</td><td>●</td><td>●</td><td>●</td><td>●</td><td>●</td><td>●</td><td>●</td><td>●</td><td>●</td><td>●</td><td>●</td><td>●</td><td>●</td><td>●</td><td>●</td><td>●</td><td>●</td><td>●</td><td>●</td><td>●</td><td>●</td></tr> <tr><td>DI Coast Stop</td><td></td><td>●</td><td>●</td><td>●</td><td>●</td><td>●</td><td>●</td><td>●</td><td>●</td><td>●</td><td>●</td><td>●</td><td>●</td><td>●</td><td>●</td><td>●</td><td>●</td><td>●</td><td>●</td><td>●</td><td>●</td><td>●</td><td>●</td><td>●</td><td>●</td></tr> <tr><td>DI Cur Lmt Stop</td><td></td><td>●</td><td>●</td><td>●</td><td>●</td><td>●</td><td>●</td><td>●</td><td>●</td><td>●</td><td>●</td><td>●</td><td>●</td><td>●</td><td>●</td><td>●</td><td>●</td><td>●</td><td>●</td><td>●</td><td>●</td><td>●</td><td>●</td><td>●</td><td>●</td></tr> <tr><td>DI Aux Fault</td><td></td><td>●</td><td>●</td><td>●</td><td>●</td><td>●</td><td>●</td><td>●</td><td>●</td><td>●</td><td>●</td><td>●</td><td>●</td><td>●</td><td>●</td><td>●</td><td>●</td><td>●</td><td>●</td><td>●</td><td>●</td><td>●</td><td>●</td><td>●</td><td>●</td></tr> <tr><td>DI Clear Fault</td><td></td><td>●</td><td>●</td><td>●</td><td>●</td><td>●</td><td>●</td><td>●</td><td>●</td><td>●</td><td>●</td><td>●</td><td>●</td><td>●</td><td>●</td><td>●</td><td>●</td><td>●</td><td>●</td><td>●</td><td>●</td><td>●</td><td>●</td><td>●</td><td>●</td></tr> <tr><td>DI HOA Start</td><td></td><td>●</td><td>●</td><td>●</td><td>●</td><td>●</td><td>●</td><td>●</td><td>●</td><td>●</td><td>●</td><td>●</td><td>●</td><td>●</td><td>●</td><td>●</td><td>●</td><td>●</td><td>●</td><td>●</td><td>●</td><td>●</td><td>●</td><td>●</td><td>●</td></tr> <tr><td>DI Start</td><td></td><td>●</td><td>●</td><td>●</td><td>●</td><td>●</td><td>●</td><td>●</td><td>●</td><td>●</td><td>●</td><td>●</td><td>●</td><td>●</td><td>●</td><td>●</td><td>●</td><td>●</td><td>●</td><td>●</td><td>●</td><td>●</td><td>●</td><td>●</td><td>●</td></tr> <tr><td>DI Run</td><td></td><td>●</td><td>●</td><td>●</td><td>●</td><td>●</td><td>●</td><td>●</td><td>●</td><td>●</td><td>●</td><td>●</td><td>●</td><td>●</td><td>●</td><td>●</td><td>●</td><td>●</td><td>●</td><td>●</td><td>●</td><td>●</td><td>●</td><td>●</td><td>●</td></tr> <tr><td>DI Run Forward<sup>(1)</sup></td><td></td><td>●</td><td>●</td><td>●</td><td>●</td><td>●</td><td>●</td><td>●</td><td>●</td><td>●</td><td>●</td><td>●</td><td>●</td><td>●</td><td>●</td><td>●</td><td>●</td><td>●</td><td>●</td><td>●</td><td>●</td><td>●</td><td>●</td><td>●</td><td>●</td></tr> <tr><td>DI Run Reverse<sup>(1)</sup></td><td></td><td>●</td><td>●</td><td>●</td><td>●</td><td>●</td><td>●</td><td>●</td><td>●</td><td>●</td><td>●</td><td>●</td><td>●</td><td>●</td><td>●</td><td>●</td><td>●</td><td>●</td><td>●</td><td>●</td><td>●</td><td>●</td><td>●</td><td>●</td><td>●</td></tr> <tr><td>DI Jog 1</td><td></td><td>●</td><td>●</td><td>●</td><td>●</td><td>●</td><td>●</td><td>●</td><td>●</td><td>●</td><td>●</td><td>●</td><td>●</td><td>●</td><td>●</td><td>●</td><td>●</td><td>●</td><td>●</td><td>●</td><td>●</td><td>●</td><td>●</td><td>●</td><td>●</td></tr> <tr><td>DI Jog 1 Forward<sup>(1)</sup></td><td></td><td>●</td><td>●</td><td>●</td><td>●</td><td>●</td><td>●</td><td>●</td><td>●</td><td>●</td><td>●</td><td>●</td><td>●</td><td>●</td><td>●</td><td>●</td><td>●</td><td>●</td><td>●</td><td>●</td><td>●</td><td>●</td><td>●</td><td>●</td><td>●</td></tr> <tr><td>DI Jog 1 Reverse<sup>(1)</sup></td><td></td><td>●</td><td>●</td><td>●</td><td>●</td><td>●</td><td>●</td><td>●</td><td>●</td><td>●</td><td>●</td><td>●</td><td>●</td><td>●</td><td>●</td><td>●</td><td>●</td><td>●</td><td>●</td><td>●</td><td>●</td><td>●</td><td>●</td><td>●</td><td>●</td></tr> <tr><td>DI Jog 2</td><td></td><td>●</td><td>●</td><td>●</td><td>●</td><td>●</td><td>●</td><td>●</td><td>●</td><td>●</td><td>●</td><td>●</td><td>●</td><td>●</td><td>●</td><td>●</td><td>●</td><td>●</td><td>●</td><td>●</td><td>●</td><td>●</td><td>●</td><td>●</td><td>●</td></tr> <tr><td>DI Jog 2 Forward<sup>(1)</sup></td><td></td><td>●</td><td>●</td><td>●</td><td>●</td><td>●</td><td>●</td><td>●</td><td>●</td><td>●</td><td>●</td><td>●</td><td>●</td><td>●</td><td>●</td><td>●</td><td>●</td><td>●</td><td>●</td><td>●</td><td>●</td><td>●</td><td>●</td><td>●</td><td>●</td></tr> <tr><td>DI Jog 2 Reverse<sup>(1)</sup></td><td></td><td>●</td><td>●</td><td>●</td><td>●</td><td>●</td><td>●</td><td>●</td><td>●</td><td>●</td><td>●</td><td>●</td><td>●</td><td>●</td><td>●</td><td>●</td><td>●</td><td>●</td><td>●</td><td>●</td><td>●</td><td>●</td><td>●</td><td>●</td><td>●</td></tr> <tr><td>DI Emergency OvrRide</td><td></td><td>●</td><td>●</td><td>●</td><td>●</td><td>●</td><td>●</td><td>●</td><td>●</td><td>●</td><td>●</td><td>●</td><td>●</td><td>●</td><td>●</td><td>●</td><td>●</td><td>●</td><td>●</td><td>●</td><td>●</td><td>●</td><td>●</td><td>●</td><td>●</td></tr> <tr><td>DI Fwd Reverse<sup>(1)</sup></td><td></td><td>●</td><td>●</td><td>●</td><td>●</td><td>●</td><td>●</td><td>●</td><td>●</td><td>●</td><td>●</td><td>●</td><td>●</td><td>●</td><td>●</td><td>●</td><td>●</td><td>●</td><td>●</td><td>●</td><td>●</td><td>●</td><td>●</td><td>●</td><td>●</td></tr> <tr><td>DI Accel 2</td><td></td><td>●</td><td>●</td><td>●</td><td>●</td><td>●</td><td>●</td><td>●</td><td>●</td><td>●</td><td>●</td><td>●</td><td>●</td><td>●</td><td>●</td><td>●</td><td>●</td><td>●</td><td>●</td><td>●</td><td>●</td><td>●</td><td>●</td><td>●</td><td>●</td></tr> <tr><td>DI Decel 2</td><td></td><td>●</td><td>●</td><td>●</td><td>●</td><td>●</td><td>●</td><td>●</td><td>●</td><td>●</td><td>●</td><td>●</td><td>●</td><td>●</td><td>●</td><td>●</td><td>●</td><td>●</td><td>●</td><td>●</td><td>●</td><td>●</td><td>●</td><td>●</td><td>●</td></tr> <tr><td>DI Manual Ctrl</td><td></td><td>●</td><td>●</td><td>●</td><td>●</td><td>●</td><td>●</td><td>●</td><td>●</td><td>●</td><td>●</td><td>●</td><td>●</td><td>●</td><td>●</td><td>●</td><td>●</td><td>●</td><td>●</td><td>●</td><td>●</td><td>●</td><td>●</td><td>●</td><td>●</td></tr> <tr><td>DI Speed Sel 0</td><td></td><td>●</td><td>●</td><td>●</td><td>●</td><td>●</td><td>●</td><td>●</td><td>●</td><td>●</td><td>●</td><td>●</td><td>●</td><td>●</td><td>●</td><td>●</td><td>●</td><td>●</td><td>●</td><td>●</td><td>●</td><td>●</td><td>●</td><td>●</td><td>●</td></tr> <tr><td>DI Speed Sel 1</td><td></td><td>●</td><td>●</td><td>●</td><td>●</td><td>●</td><td>●</td><td>●</td><td>●</td><td>●</td><td>●</td><td>●</td><td>●</td><td>●</td><td>●</td><td>●</td><td>●</td><td>●</td><td>●</td><td>●</td><td>●</td><td>●</td><td>●</td><td>●</td><td>●</td></tr> <tr><td>DI Speed Sel 2</td><td></td><td>●</td><td>●</td><td>●</td><td>●</td><td>●</td><td>●</td><td>●</td><td>●</td><td>●</td><td>●</td><td>●</td><td>●</td><td>●</td><td>●</td><td>●</td><td>●</td><td>●</td><td>●</td><td>●</td><td>●</td><td>●</td><td>●</td><td>●</td><td>●</td></tr> <tr><td>DI Stop Mode B</td><td></td><td>●</td><td>●</td><td>●</td><td>●</td><td>●</td><td>●</td><td>●</td><td>●</td><td>●</td><td>●</td><td>●</td><td>●</td><td>●</td><td>●</td><td>●</td><td>●</td><td>●</td><td>●</td><td>●</td><td>●</td><td>●</td><td>●</td><td>●</td><td>●</td></tr> </tbody> </table>		DI Stop Mode B	DI Speed Sel 2	DI Speed Sel 1	DI Speed Sel 0	DI Manual Ctrl	DI Decel 2	DI Accel 2	DI Fwd Reverse <sup>(1)</sup>	DI Emergency OvrRide	DI Jog 2 Reverse <sup>(1)</sup>	DI Jog 2 Forward <sup>(1)</sup>	DI Jog 2	DI Jog 1 Reverse <sup>(1)</sup>	DI Jog 1 Forward <sup>(1)</sup>	DI Jog 1	DI Run Reverse <sup>(1)</sup>	DI Run Forward <sup>(1)</sup>	DI Run	DI Start	DI HOA Start	DI Clear Fault	DI Aux Fault	DI Cur Lmt Stop	DI Coast Stop	DI Stop	DI Stop	●	●	●	●	●	●	●	●	●	●	●	●	●	●	●	●	●	●	●	●	●	●	●	●	●	DI Coast Stop		●	●	●	●	●	●	●	●	●	●	●	●	●	●	●	●	●	●	●	●	●	●	●	●	DI Cur Lmt Stop		●	●	●	●	●	●	●	●	●	●	●	●	●	●	●	●	●	●	●	●	●	●	●	●	DI Aux Fault		●	●	●	●	●	●	●	●	●	●	●	●	●	●	●	●	●	●	●	●	●	●	●	●	DI Clear Fault		●	●	●	●	●	●	●	●	●	●	●	●	●	●	●	●	●	●	●	●	●	●	●	●	DI HOA Start		●	●	●	●	●	●	●	●	●	●	●	●	●	●	●	●	●	●	●	●	●	●	●	●	DI Start		●	●	●	●	●	●	●	●	●	●	●	●	●	●	●	●	●	●	●	●	●	●	●	●	DI Run		●	●	●	●	●	●	●	●	●	●	●	●	●	●	●	●	●	●	●	●	●	●	●	●	DI Run Forward <sup>(1)</sup>		●	●	●	●	●	●	●	●	●	●	●	●	●	●	●	●	●	●	●	●	●	●	●	●	DI Run Reverse <sup>(1)</sup>		●	●	●	●	●	●	●	●	●	●	●	●	●	●	●	●	●	●	●	●	●	●	●	●	DI Jog 1		●	●	●	●	●	●	●	●	●	●	●	●	●	●	●	●	●	●	●	●	●	●	●	●	DI Jog 1 Forward <sup>(1)</sup>		●	●	●	●	●	●	●	●	●	●	●	●	●	●	●	●	●	●	●	●	●	●	●	●	DI Jog 1 Reverse <sup>(1)</sup>		●	●	●	●	●	●	●	●	●	●	●	●	●	●	●	●	●	●	●	●	●	●	●	●	DI Jog 2		●	●	●	●	●	●	●	●	●	●	●	●	●	●	●	●	●	●	●	●	●	●	●	●	DI Jog 2 Forward <sup>(1)</sup>		●	●	●	●	●	●	●	●	●	●	●	●	●	●	●	●	●	●	●	●	●	●	●	●	DI Jog 2 Reverse <sup>(1)</sup>		●	●	●	●	●	●	●	●	●	●	●	●	●	●	●	●	●	●	●	●	●	●	●	●	DI Emergency OvrRide		●	●	●	●	●	●	●	●	●	●	●	●	●	●	●	●	●	●	●	●	●	●	●	●	DI Fwd Reverse <sup>(1)</sup>		●	●	●	●	●	●	●	●	●	●	●	●	●	●	●	●	●	●	●	●	●	●	●	●	DI Accel 2		●	●	●	●	●	●	●	●	●	●	●	●	●	●	●	●	●	●	●	●	●	●	●	●	DI Decel 2		●	●	●	●	●	●	●	●	●	●	●	●	●	●	●	●	●	●	●	●	●	●	●	●	DI Manual Ctrl		●	●	●	●	●	●	●	●	●	●	●	●	●	●	●	●	●	●	●	●	●	●	●	●	DI Speed Sel 0		●	●	●	●	●	●	●	●	●	●	●	●	●	●	●	●	●	●	●	●	●	●	●	●	DI Speed Sel 1		●	●	●	●	●	●	●	●	●	●	●	●	●	●	●	●	●	●	●	●	●	●	●	●	DI Speed Sel 2		●	●	●	●	●	●	●	●	●	●	●	●	●	●	●	●	●	●	●	●	●	●	●	●	DI Stop Mode B		●	●	●	●	●	●	●	●	●	●	●	●	●	●	●	●	●	●	●	●	●	●	●	●
	DI Stop Mode B	DI Speed Sel 2	DI Speed Sel 1	DI Speed Sel 0	DI Manual Ctrl	DI Decel 2	DI Accel 2	DI Fwd Reverse <sup>(1)</sup>	DI Emergency OvrRide	DI Jog 2 Reverse <sup>(1)</sup>	DI Jog 2 Forward <sup>(1)</sup>	DI Jog 2	DI Jog 1 Reverse <sup>(1)</sup>	DI Jog 1 Forward <sup>(1)</sup>	DI Jog 1	DI Run Reverse <sup>(1)</sup>	DI Run Forward <sup>(1)</sup>	DI Run	DI Start	DI HOA Start	DI Clear Fault	DI Aux Fault	DI Cur Lmt Stop	DI Coast Stop	DI Stop																																																																																																																																																																																																																																																																																																																																																																																																																																																																																																																																																																																																																																																																																			
DI Stop	●	●	●	●	●	●	●	●	●	●	●	●	●	●	●	●	●	●	●	●	●	●	●	●	●																																																																																																																																																																																																																																																																																																																																																																																																																																																																																																																																																																																																																																																																																			
DI Coast Stop		●	●	●	●	●	●	●	●	●	●	●	●	●	●	●	●	●	●	●	●	●	●	●	●																																																																																																																																																																																																																																																																																																																																																																																																																																																																																																																																																																																																																																																																																			
DI Cur Lmt Stop		●	●	●	●	●	●	●	●	●	●	●	●	●	●	●	●	●	●	●	●	●	●	●	●																																																																																																																																																																																																																																																																																																																																																																																																																																																																																																																																																																																																																																																																																			
DI Aux Fault		●	●	●	●	●	●	●	●	●	●	●	●	●	●	●	●	●	●	●	●	●	●	●	●																																																																																																																																																																																																																																																																																																																																																																																																																																																																																																																																																																																																																																																																																			
DI Clear Fault		●	●	●	●	●	●	●	●	●	●	●	●	●	●	●	●	●	●	●	●	●	●	●	●																																																																																																																																																																																																																																																																																																																																																																																																																																																																																																																																																																																																																																																																																			
DI HOA Start		●	●	●	●	●	●	●	●	●	●	●	●	●	●	●	●	●	●	●	●	●	●	●	●																																																																																																																																																																																																																																																																																																																																																																																																																																																																																																																																																																																																																																																																																			
DI Start		●	●	●	●	●	●	●	●	●	●	●	●	●	●	●	●	●	●	●	●	●	●	●	●																																																																																																																																																																																																																																																																																																																																																																																																																																																																																																																																																																																																																																																																																			
DI Run		●	●	●	●	●	●	●	●	●	●	●	●	●	●	●	●	●	●	●	●	●	●	●	●																																																																																																																																																																																																																																																																																																																																																																																																																																																																																																																																																																																																																																																																																			
DI Run Forward <sup>(1)</sup>		●	●	●	●	●	●	●	●	●	●	●	●	●	●	●	●	●	●	●	●	●	●	●	●																																																																																																																																																																																																																																																																																																																																																																																																																																																																																																																																																																																																																																																																																			
DI Run Reverse <sup>(1)</sup>		●	●	●	●	●	●	●	●	●	●	●	●	●	●	●	●	●	●	●	●	●	●	●	●																																																																																																																																																																																																																																																																																																																																																																																																																																																																																																																																																																																																																																																																																			
DI Jog 1		●	●	●	●	●	●	●	●	●	●	●	●	●	●	●	●	●	●	●	●	●	●	●	●																																																																																																																																																																																																																																																																																																																																																																																																																																																																																																																																																																																																																																																																																			
DI Jog 1 Forward <sup>(1)</sup>		●	●	●	●	●	●	●	●	●	●	●	●	●	●	●	●	●	●	●	●	●	●	●	●																																																																																																																																																																																																																																																																																																																																																																																																																																																																																																																																																																																																																																																																																			
DI Jog 1 Reverse <sup>(1)</sup>		●	●	●	●	●	●	●	●	●	●	●	●	●	●	●	●	●	●	●	●	●	●	●	●																																																																																																																																																																																																																																																																																																																																																																																																																																																																																																																																																																																																																																																																																			
DI Jog 2		●	●	●	●	●	●	●	●	●	●	●	●	●	●	●	●	●	●	●	●	●	●	●	●																																																																																																																																																																																																																																																																																																																																																																																																																																																																																																																																																																																																																																																																																			
DI Jog 2 Forward <sup>(1)</sup>		●	●	●	●	●	●	●	●	●	●	●	●	●	●	●	●	●	●	●	●	●	●	●	●																																																																																																																																																																																																																																																																																																																																																																																																																																																																																																																																																																																																																																																																																			
DI Jog 2 Reverse <sup>(1)</sup>		●	●	●	●	●	●	●	●	●	●	●	●	●	●	●	●	●	●	●	●	●	●	●	●																																																																																																																																																																																																																																																																																																																																																																																																																																																																																																																																																																																																																																																																																			
DI Emergency OvrRide		●	●	●	●	●	●	●	●	●	●	●	●	●	●	●	●	●	●	●	●	●	●	●	●																																																																																																																																																																																																																																																																																																																																																																																																																																																																																																																																																																																																																																																																																			
DI Fwd Reverse <sup>(1)</sup>		●	●	●	●	●	●	●	●	●	●	●	●	●	●	●	●	●	●	●	●	●	●	●	●																																																																																																																																																																																																																																																																																																																																																																																																																																																																																																																																																																																																																																																																																			
DI Accel 2		●	●	●	●	●	●	●	●	●	●	●	●	●	●	●	●	●	●	●	●	●	●	●	●																																																																																																																																																																																																																																																																																																																																																																																																																																																																																																																																																																																																																																																																																			
DI Decel 2		●	●	●	●	●	●	●	●	●	●	●	●	●	●	●	●	●	●	●	●	●	●	●	●																																																																																																																																																																																																																																																																																																																																																																																																																																																																																																																																																																																																																																																																																			
DI Manual Ctrl		●	●	●	●	●	●	●	●	●	●	●	●	●	●	●	●	●	●	●	●	●	●	●	●																																																																																																																																																																																																																																																																																																																																																																																																																																																																																																																																																																																																																																																																																			
DI Speed Sel 0		●	●	●	●	●	●	●	●	●	●	●	●	●	●	●	●	●	●	●	●	●	●	●	●																																																																																																																																																																																																																																																																																																																																																																																																																																																																																																																																																																																																																																																																																			
DI Speed Sel 1		●	●	●	●	●	●	●	●	●	●	●	●	●	●	●	●	●	●	●	●	●	●	●	●																																																																																																																																																																																																																																																																																																																																																																																																																																																																																																																																																																																																																																																																																			
DI Speed Sel 2		●	●	●	●	●	●	●	●	●	●	●	●	●	●	●	●	●	●	●	●	●	●	●	●																																																																																																																																																																																																																																																																																																																																																																																																																																																																																																																																																																																																																																																																																			
DI Stop Mode B		●	●	●	●	●	●	●	●	●	●	●	●	●	●	●	●	●	●	●	●	●	●	●	●																																																																																																																																																																																																																																																																																																																																																																																																																																																																																																																																																																																																																																																																																			
(1) Parameter setting is not compatible with parameter 308 [Direction Mode] being set to “Bipolar.” If this parameter alarms, check that P308 is set to “Unipolar.”																																																																																																																																																																																																																																																																																																																																																																																																																																																																																																																																																																																																																																																																																																												
161	Sleep Config	Alarm 2						There is a Sleep/Wake configuration error. With Sleep Wake Mode = Direct, possible causes include: Drive is stopped and Wake Level < Sleep Level. Stop=CF, Run, Run Fwd, or Run Rev is not configured in Digital Input functions.																																																																																																																																																																																																																																																																																																																																																																																																																																																																																																																																																																																																																																																																																																				
162	Waking	Alarm 1						The Wake timer is counting toward a value that starts the drive.																																																																																																																																																																																																																																																																																																																																																																																																																																																																																																																																																																																																																																																																																																				
168	HeatSinkUnderTemp	Resettable Fault					Bit 2 “PwrStrucFlts”	Heatsink temperature sensor is reporting a value below -18.7 °C (-1.66 °F) or the sensor feedback circuit is open. See P943 [Drive Temp Pct] and/or P944 [Drive Temp C].																																																																																																																																																																																																																																																																																																																																																																																																																																																																																																																																																																																																																																																																																																				

Event No.	Fault/Alarm Text	Type	Fault Action	Configuration Parameter	Auto Reset	Auto Clear	Emerg Prot OVRD	Description/Actions
169	PWM Freq Reduced	Alarm 1						The PWM Frequency has been reduced from the value set in P38 [PWM Frequency] due to excessive IGBT junction temperatures. See also P420 [Drive OL Mode].
170	CurLimit Reduced	Alarm 1						The current limit value has been reduced from the value set in [Current Limit <i>n</i> ] due to excessive IGBT junction temperatures or P940 [Drive OL Count] = 95 %. See also P420 [Drive OL Mode].
171	Adj Vltg Ref	Alarm 1						Invalid adjustable-voltage reference selection conflict.
175	Travel Lim Cflct	Non-Reset Fault	Current Limit Stop					Travel limits are in conflict. Both the forward and reverse travel limits indicate that they are simultaneously active. If digital limits (hardware signals) are in use, ensure that the following forward and reverse digital input pairs are not both off simultaneously: fwd/rev decel travel limit digital inputs and fwd/rev end stop travel limit digital inputs. The travel limit digital inputs are meant to be connected to normally closed switch contacts, so the digital input status reads an off (0 = False) bit status when the machine is on limit and the switch contact opens. A possible cause for this condition is loss of common power to both the forward and reverse travel limit switches.  If software travel limits are in use, check the state of the fwd/rev travel limit bits in P1101 [Trq Prove Setup]. These bits read an on (1 = Enabled) bit status when the machine is on limit. Bit 2 "Decel Fwd" and Bit 4 "Decel Rev" should not be on simultaneously. Similarly, Bit 3 "End Stop Fwd" and Bit 5 "End Stop Rev" should not be on simultaneously.
176	Home Config	Alarm 2						Home to Torque config conflict
177	Profiling Active	Alarm 1						The Profile/Indexer is active.
178	Homing Active	Alarm 1						The Homing function is active.
179	Home Not Set	Alarm 1						The Home position was not set before profile operation.
181	Fwd End Limit	Resettable Fault	Current Limit Stop				Bit 8 "Board Faults"	The selected digital input for one of the end limit switches, P196 [DI Fwd End Limit] or P198 [DI Rev End Limit], has detected a falling edge and P313 [Actv SpTqPs Mode] is not set to 1 "Speed Reg."  If digital limits (hardware signals) are in use, ensure that the digital inputs are connected to normally closed contacts. When the end limit is reached the contacts open.
182	Rev End Limit	Resettable Fault	Current Limit Stop				Bit 8 "Board Faults"	The selected digital input for one of the end limit switches, P196 [DI Fwd End Limit] or P198 [DI Rev End Limit], has detected a falling edge and P313 [Actv SpTqPs Mode] is not set to 1 "Speed Reg."  If digital limits (hardware signals) are in use, ensure that the digital inputs are connected to normally closed contacts. When the end limit is reached the contacts open.
185	Freq Conflict	Alarm 2						Indicates that the values of P520 [Max Fwd Speed] and P521 [Max Rev Speed] are in conflict with the value of P63 [Break Frequency].
186	VHz Neg Slope	Alarm 2						Indicates that the V/Hz curve segment resulted in a negative V/Hz slope. See P60 [Start Acc Boost] through P63 [Break Frequency].
187	VHz Boost Limit	Alarm 2						Indication that one of the two following conditions exists. <ul style="list-style-type: none"> <li>• P60 [Start/Acc Boost] and P61 [Run Boost] are greater than P25 [Motor NP Volts] x 0.25 when P65 [VHz Curve] = 0 "Custom V/Hz."</li> <li>• P61 [Run Boost] is greater than P25 [Motor NP Volts] x 0.25 when P65 [VHz Curve] = 1 "Fan/Pump."</li> </ul>

Event No.	Fault/Alarm Text	Type	Fault Action	Configuration Parameter	Auto Reset	Auto Clear	Emerg Prot OVRD	Description/Actions
190	PM FV Pri Fdbk	Alarm 2						Indicates a control mode and primary-feedback device configuration error. P35 [Motor Ctrl Mode] is set to the permanent magnet flux vector "PM FV" control mode, P125 [Pri Vel Fdbk Sel] is set to P137 [Open Loop Fdbk] (port 0).
191	PM FV Alt Fdbk	Alarm 2						Indicates a control mode and alternate-feedback device configuration error. P35 [Motor Ctrl Mode] is set to the permanent magnet flux vector "PM FV" control mode, P635 [Spd Options Ctrl] is set to bit 7 "Auto Tach SW," P128 [Alt Vel Fdbk Sel] is set to P137 [Open Loop Fdbk] (port 0).
192	Fwd Spd Lim Cfg	Alarm 2						The forward speed reference is out of range. Verify the settings of P38 [PWM Frequency] and P520 [Max Fwd Speed]. Lower carrier frequencies reduce the output frequency range. Verify that P522 [Min Fwd Speed] is less than or equal to P520 [Max Fwd Speed].
193	Rev Spd Lim Cfg	Alarm 2						The reverse speed reference is out of range. Verify the settings of P38 [PWM Frequency] and P521 [Max Rev Speed]. Lower carrier frequencies reduce the output frequency range. Verify that P523 [Min Rev Speed] is greater than or equal to P521 [Max Rev Speed].
194	PM Offset Conflict	Alarm 2						Both P80 [PM Cfg] bit 0 "AutoOfstTest" and bit 2 "StaticLestEn" are set. Select only one.
195	IPMSpdEstErr	Resettable Fault	Coast				Bit 9 "Fdbk Faults"	Speed Estimator failed to track High-Speed angle.
196	PM FS Cflct	Alarm 2						Attempted to set P356 [FlyingStart Mode] to 2 "Sweep" with a permanent magnet motor selected in P35 [Motor Ctrl Mode].
197	PM Offset Failed	Resettable Fault	Coast				Bit 0 "PwrStrucFlts"	Indicates that the PM Offset test failed due to interruption of the test before completion or the motor movement failed to reach the proper amount of rotation during the test. The test is rescheduled when this fault occurs. If failure occurred because of movement limitations, increase the [PM OfstTst Cur]. If this solution fails to correct the problem, the load on the motor maybe too large.
201	SpdReg DL Err	Alarm 2						Attempted to establish a Datalink to P644 [Spd Err Flt BW], P645 [Speed Reg Kp], or P647 [Speed Reg Ki] and P636 [Speed Reg BW] is set to a value other than zero.
202	AltSpdReg DL Err	Alarm 2						Attempted to establish a Datalink to P649 [Alt Speed Reg Kp], P650 [Alt Speed Reg Ki], or P651 [AltSpdErr FltrBW] and P648 [Alt Speed Reg BW] is set to a value other than zero.
203	Port 13 Adapter	Resettable Fault	Coast				Bit 6 "ENET PrtFlts"	The embedded EtherNet/IP adapter has a fault. See EtherNet event queue.
204	Port 14 Adapter	Resettable Fault	Coast				Bit 7 "DevLogixFlts"	The DeviceLogix adapter has a fault.
205	DPI TransportErr	Alarm 1						A DPI Communication Error has occurred.
210	HW Enbl Jmpr Out	Resettable Fault	Coast				Bit 8 "Board Faults"	A Safety Option module is present and ENABLE Jumper is removed. Install the jumper. This fault occurs only on frames 1...7.

Event No.	Fault/Alarm Text	Type	Fault Action	Configuration Parameter	Auto Reset	Auto Clear	Emerg Prot OVRD	Description/Actions
211	Safety Brd Fault	Resettable Fault	Coast				Bit 8 "Board Faults"	A Safety option module has indicated a fault. Verify that ENABLE Jumper is installed. Reset or power cycle drive. Safe Speed Monitor (20-750-S1): <ul style="list-style-type: none"> <li>See P67 [Fault Status] on <a href="#">page 308</a> for more information on the fault statuses.</li> <li>See publication <a href="#">750-RM001</a> for more information.</li> </ul> Safe Torque Off (20-750-S): <ul style="list-style-type: none"> <li>If DC power drops below 17V DC "Not Enable" is indicated.</li> <li>If voltage drops below 11V DC the module faults.</li> <li>See publication <a href="#">750-UM002</a> for more information.</li> </ul> ATEX (20-750-ATEX): <ul style="list-style-type: none"> <li>Possible hardware damage.</li> <li>The motor to the thermal sensor is shorted.</li> <li>Excessive EMC noise due to improper grounding/shielding.</li> <li>See publication <a href="#">750-UM003</a> for more information.</li> </ul>
212	Safety Jmpr Out	Resettable Fault	Coast				Bit 8 "Board Faults"	SAFETY Jumper is not installed and a Safety option module is not present. Install the jumper.
213	Safety Jumper In	Resettable Fault	Coast				Bit 8 "Board Faults"	SAFETY Jumper is installed and a Safety option module is present. Remove the jumper.
214	SafetyPortCnflct	Alarm 2						Allowable number of safety options exceeded. Only one safety option module can be installed at a time.
224	Port 4 Comm Loss	Resettable Fault	Coast				Bit 12 "Port 4 Flts"	The device at the port has stopped communicating with the main control board. Verify that the device is present and functional. Verify network connections. Verify options that are installed in ports 4...8 are seated in the port and secured with mounting screws.
225	Port 5 Comm Loss			Bit 13 "Port 5 Flts"				
226	Port 6 Comm Loss			Bit 14 "Port 6 Flts"				
227	Port 7 Comm Loss			Bit 15 "Port 7 Flts"				
228	Port 8 Comm Loss			Bit 16 "Port 8 Flts"				
229	Port 9 Comm Loss			Bit 17 "Port 9 Flts"				
230	Port10 Comm Loss							
231	Port11 Comm Loss							
232	Port12 Comm Loss							
233	Port13 Comm Loss			Bit 6 "ENET PrtFlts"				
234	Port14 Comm Loss			Bit 7 "DevLogixFlts"				
244	Port 4 Cfg	Alarm 2						The main control board does not have the correct option in the port. Option may not be compatible with product or MCB firmware must be updated to support it. Option may have to be moved or removed, accept option configuration change.
245	Port 5 Cfg							
246	Port 6 Cfg							
247	Port 7 Cfg							
248	Port 8 Cfg							
249	Port 9 Cfg							
250	Port 10 Cfg							
251	Port 11 Cfg							
252	Port 12 Cfg							
253	Port 13 Cfg							
254	Port 14 Cfg							

Event No.	Fault/Alarm Text	Type	Fault Action	Configuration Parameter	Auto Reset	Auto Clear	Emerg Prot OVRD	Description/Actions
264	Port 4 Checksum	Resettable Fault	Coast				Bit 12 "Port 4 Flts"	An option module storage checksum failed. Option data has been set to default values.
265	Port 5 Checksum						Bit 13 "Port 5 Flts"	
266	Port 6 Checksum						Bit 14 "Port 6 Flts"	
267	Port 7 Checksum						Bit 15 "Port 7 Flts"	
268	Port 8 Checksum						Bit 16 "Port 8 Flts"	
269	Port 9 Checksum						Bit 17 "Port 9 Flts"	
270	Port10 Checksum							
271	Port11 Checksum							
272	Port12 Checksum							
273	Port13 Checksum						Bit 6 "ENET PrtFlts"	
274	Port14 Checksum				Bit 7 "DevLogixFlts"			
281	Enet Checksum	Resettable Fault	Coast				Bit 6 "ENET PrtFlts"	EtherNet/IP storage checksum failed. Data set to default values.
282	DLX Checksum	Resettable Fault	Coast				Bit 7 "DevLogixFlts"	DeviceLogix storage checksum failed. Data set to default values.
290	Prev Maint Reset	Alarm 1						Predictive maintenance function has reset an elapsed life parameter.
291	HSFan Life	Configurable		<a href="#">493</a> [HSFan EventActn]			Bit 8 "Board Faults"	Predictive maintenance function has reached the event level. Perform maintenance.
292	InFan Life	Configurable		<a href="#">500</a> [InFan EventActn]			Bit 8 "Board Faults"	
293	MtrBrng Life	Configurable		<a href="#">506</a> [MtrBrngEventActn]			Bit 8 "Board Faults"	
294	MtrBrng Lube	Configurable		<a href="#">510</a> [MtrLubeEventActn]			Bit 8 "Board Faults"	
295	MachBrng Life	Configurable		<a href="#">515</a> [MtrBrngEventActn]			Bit 8 "Board Faults"	
296	MachBrng Lube	Configurable		<a href="#">519</a> [MchLubeEventActn]			Bit 8 "Board Faults"	
300	Emer Ovr Act	---						Emergency Override Active Emergency Override is currently active
301	Emer Ovr Not Act	---						Emergency Override Not Active Emergency Override is not currently active.
307	Port7InvalidCard	Non-Reset Fault	Coast					Option not valid in that port. Remove option module.
308	Port8InvalidCard	Non-Reset Fault	Coast					
310	Regeneration OK	Resettable Fault	Coast					The drive has detected that the 'Regeneration OK' input has transition to an 'inactive' state.

Event No.	Fault/Alarm Text	Type	Fault Action	Configuration Parameter	Auto Reset	Auto Clear	Emerg Prot OVRD	Description/Actions
315	Excess Psn Err	Configurable		Configured with Logix controller.				The absolute maximum Position Error value has been exceeded.
318 319 320	OutCurShare PhU OutCurShare PhV OutCurShare PhW	Alarm 1						There is output current sharing imbalance between parallel inverters in the phase indicated that is greater than 15 % of the inverter rated current.
322	N-1 Operation	Alarm 1		<a href="#">20</a> (Port 10) [Recfg Acknowledg] <a href="#">21</a> (Port 10) [Effctv I Rating]				Drive is operating with fewer inverters than the original parallel configuration.
324	DC Bus Mismatch	Non-Reset Fault	Coast					There is a bus voltage imbalance between parallel inverters that is greater than 50V DC.
327 328 329	HS Temp Imbal U HS Temp Imbal V HS Temp Imbal W	Alarm 1						There is a heatsink temperature imbalance between parallel inverters in the phase indicated that is greater than 11.5 °C (52.7 °F).
331 332 333	I1 Comm Loss I2 Comm Loss I3 Comm Loss	Resettable Fault	Coast					A communications fault has occurred between the main control board and the power layer interface board on inverter <i>n</i> .
341 342 343	C1 Comm Loss C2 Comm Loss C3 Comm Loss	Resettable Fault	Coast					A communications fault has occurred between the main control board and the converter gate board on converter <i>n</i> .
351 352 353	In Cur Share L1 In Cur Share L2 In Cur Share L3	Alarm 1						There is an input current sharing imbalance between parallel converters in the AC line indicated that is greater than 15 % of the converter rated current.
357 358 359	In Vlt Imbal L12 In Vlt Imbal L23 In Vlt Imbal L31	Alarm 1						There is an input line voltage imbalance between parallel converters in the AC lines indicated that is greater than 5 % of the converter rated voltage.
360	N-1 See Manual	Resettable Fault	Coast				Bit 8 "Board Faults"	The number of active inverters has been reduced from the original parallel configuration. See <a href="#">N-1 and Re-Rate Functions on page 353</a> .
361	Rerate See Manual	Resettable Fault	Coast				Bit 8 "Board Faults"	The drive rating has changed from the original parallel configuration. See <a href="#">N-1 and Re-Rate Functions on page 353</a> .
362	Cnv/Inv Mismatch	Alarm 2						There is a voltage class mismatch between the installed parallel inverters and converters.
363	CBP/Inv Mismatch	Alarm 2						There is a voltage class mismatch between the installed parallel inverters and common DC bus precharge units.
364	CBP Num Mismatch	Alarm 2						The number of active inverters and active common DC bus precharge units does not match.
365	Zero Cnv/Prechg	Alarm 2						No converter or common DC bus precharge unit exists.
366	Cnv Num Mismatch	Alarm 2						The number of active inverters and active converters does not match.
371 372	P1 Comm Loss P2 Comm Loss	Resettable Fault	Coast					A communications fault has occurred between the main control board and the DC precharge control board on the common DC bus precharge unit <i>n</i> .
380	PWM FPGA Overrun	Alarm 1						The time limit on the PWM write to the FPGA was exceeded.

Event No.	Fault/Alarm Text	Type	Fault Action	Configuration Parameter	Auto Reset	Auto Clear	Emerg Prot OVRD	Description/Actions
900	900	Automatic Drive Reset	Coast					Critical input exception. Contact technical support.
901	Machine Check	Automatic Drive Reset	Coast					Internal error. Replace the main control board.
902	Data Storage Error	Automatic Drive Reset	Coast					Cache memory corrupt. Replace the main control board.
903	Instruction Storage Error	Automatic Drive Reset	Coast					Cache memory corrupt. Replace the main control board.
905	Alignment Error	Automatic Drive Reset	Coast					Pointer is pointing to a non-boundary member. Obtain test points and check grounding.
906	Program Error	Automatic Drive Reset	Coast					Bad memory read. Check grounding or replace the main control board.
907	Floating Point Unit Not On	Automatic Drive Reset	Coast					Firmware issue. Obtain test points.
909	Aux Processor Not On	Automatic Drive Reset	Coast					Auxiliary processor interrupt. Contact technical support.
912	Watchdog	Automatic Drive Reset	Coast					The timer counted down, reached 0, and fault occurred. Replace the main control board.
913	Data TLB Error	Automatic Drive Reset	Coast					Processor attempted to access non-boundary memory. Check grounding or replace the main control board.
914	Instruction TLB Error	Automatic Drive Reset	Coast					Processor attempted to access non-boundary memory. Check grounding or replace the main control board.
916	FPGA Failed to Load	Automatic Drive Reset	Coast					MCB failed to load on powerup. Replace the main control board.
917	FPGA CRC Failure	Resettable Fault (753) Disabled (755 LP) Automatic Drive Reset (755 HP)	Coast	964 [CRC Flt Cfg] 753 only				Change fault configuration (753). Replace the main control board.
918	Control Task Overrun	Automatic Drive Reset	Coast					Carrier frequency changes when passing through 7 Hz. In P40 [Mtr Option Cfg], set the PWM to 2 kHz or turn on the "PWM FreqLock" Bit 9. Or flash the drive to 8.001.
919	System Task Overrun	Automatic Drive Reset	Coast					The control task not finished and being told to run again. If fault does not clear, replace the main control board.
920	5 mSec Task Overrun	Automatic Drive Reset	Coast					The control task not finished and being told to run again. If fault does not clear, replace the main control board.
921	Control Task Stall	Automatic Drive Reset	Coast					Control task stalled. Check grounding or replace the main control board.
922	System Task Stall	Automatic Drive Reset	Coast					System task stalled. Check grounding or replace the main control board.
923	5 mSec Task Stall	Automatic Drive Reset	Coast					5 msec task stalled. Check grounding or replace the main control board.
924	Background Task Stall	Automatic Drive Reset	Coast					Background task stalled. Check grounding or replace the main control board.
925	Stack Overflow	Automatic Drive Reset	Coast					Firmware overflow. Obtain test points.

Event No.	Fault/Alarm Text	Type	Fault Action	Configuration Parameter	Auto Reset	Auto Clear	Emerg Prot OVRD	Description/Actions
926	Ethernet Error	Automatic Drive Reset	Coast					Ethernet error. Contact technical support.
927	CIP Motion Error	Automatic Drive Reset	Coast					Integrated motion error. Contact technical support.
14037	Net IO Timeout	Configurable		<a href="#">52</a> [DLX Prog Cond]				DeviceLogix has been disabled.

**IMPORTANT** A module installed in a port generate fault and alarm event numbers 3000...13999. See [Fault and Alarm Display Codes on page 319](#) for an explanation. For event numbers that fall from 13000 to 13999, refer to the PowerFlex 755 Drive Embedded EtherNet/IP Adapter User Manual, publication [750COM-UM001](#) for descriptions.



**Table 11 - Drive Fault and Alarm Cross Reference By Name**

<b>Fault/Alarm Text</b>	<b>Number</b>	<b>Fault/Alarm Text</b>	<b>Number</b>
Adj Vltg Ref	171	Ext Prechrg Err	137
Alt VelFdbk Loss	94	Fwd Spd Lim Cfg	192
AltSpdReg DL Err	202	Ground Fault	13
Analog In Loss	29	Ground Warning	14
Anlg Cal Chksum	108	Heatsink OvrTemp	8
App ID Changed	124	HeatSinkUnderTmp	168
AutClrFitExhaust	34	Home Config	176
AuRsts Exhausted	33	Home Not Set	179
Autn Enc Angle	141	Homing Active	178
Autn Spd Rstrct	142	HS Temp Imbal U	327
Auto Tach Switch	97	HS Temp Imbal V	328
AutoTune Aborted	80	HS Temp Imbal W	329
Autotune CurReg	143	HSFan Life	291
Autotune Inertia	144	Hw Enable Check	93
Autotune Travel	145	HW Enbl Jmpr Out	210
Aux VelFdbk Loss	95	HW OverCurrent	12
Auxiliary Input	2	I1 Comm Loss	331
Bipolar Conflict	155	I2 Comm Loss	332
Brake Slipped	26	In Cur Share L1	351
C1 Comm Loss	341	In Cur Share L2	352
C2 Comm Loss	342	In Cur Share L3	353
CBP Num Mismatch	364	In Vlt Imbal L12	357
CBP/Inv Mismatch	363	In Vlt Imbal L23	358
Clr Fault Queue	51	In Vlt Imbal L31	359
Cnv Num Mismatch	366	Incompat MCB-PB	106
Cnv/Inv Mismatch	362	InFan Life	292
Comm Loss Net	280	Input Phase Loss	17
Ctrl Bd Overtemp	55	Invalid Code	59
CurLimit Reduced	170	IPM OverCurrent	35
DC Bus Mismatch	324	IPMSpdEstErr	195
Decel Inhibit	24	IR Volts Range	77
DigIn Cfg B	157	Ivld Pwr Bd Data	110
DigIn Cfg C	158	IXo VoltageRange	87
DLX Checksum	282	Load Loss	15
DPI TransportErr	205	MachBrng Life	295
Drive OverLoad	64	MachBrng Lube	296
Drive Powerup	49	Module Defaulted	58
DynBrake OvrTemp	10	Motor Overload	7
Emer Ovr Act	300	Motor PTC Trip	18
Emer Ovr Not Act	301	MtrBrng Life	293
Enet Checksum	281	MtrBrng Lube	294
Excess Psn Err	315	N-1 Operation	322
Excessive Load	79	N-1 See Manual	360

Fault/Alarm Text	Number
FluxAmpsRef Rang	78
Freq Conflict	185
Fwd End Limit	181

Fault/Alarm Text	Number
Net IO Timeout	14037
No Stop Source	152
NVS Not Blank	102

Fault/Alarm Text	Number
OutCurShare PhU	318
OutCurShare PhV	319
OutCurShare PhW	320
Output PhaseLoss	21
OverSpeed Limit	25
OverVoltage	5
OW Torq Level	66
OW Torq Level Lo	68
P1 Comm Loss	371
P2 Comm Loss	372
Parameter Chksum	100
Phase U to Grnd	38
Phase UNegToGrnd	44
Phase UV Short	41
Phase V to Grnd	39
Phase VNegToGrnd	45
Phase VW Short	42
Phase W to Grnd	40
Phase WNegToGrnd	46
Phase WU Short	43
PM FS Cfict	196
PM FV Alt Fdbk	191
PM FV Pri Fdbk	190
PM Offset Conflict	194
PM Offset Failed	197
Port 1 Adapter	71
Port 1 DPI Loss	81
Port 10 Cfg	250
Port 11 Cfg	251
Port 12 Cfg	252
Port 13 Adapter	203
Port 13 Cfg	253
Port 14 Adapter	204
Port 14 Cfg	254
Port 2 Adapter	72
Port 2 DPI Loss	82
Port 3 Adapter	73
Port 3 DPI Loss	83
Port 4 Adapter	74

Fault/Alarm Text	Number
Port 5 Checksum	265
Port 5 Comm Loss	225
Port 5 DPI Loss	85
Port 6 Adapter	76
Port 6 Cfg	246
Port 6 Checksum	266
Port 6 Comm Loss	226
Port 6 DPI Loss	86
Port 7 Cfg	247
Port 7 Checksum	267
Port 7 Comm Loss	227
Port 8 Cfg	248
Port 8 Checksum	268
Port 8 Comm Loss	228
Port 9 Cfg	249
Port 9 Checksum	269
Port 9 Comm Loss	229
Port10 Checksum	270
Port10 Comm Loss	230
Port11 Checksum	271
Port11 Comm Loss	231
Port12 Checksum	272
Port12 Comm Loss	232
Port13 Checksum	273
Port13 Comm Loss	233
Port14 Checksum	274
Port14 Comm Loss	234
Port7InvalidCard	307
Port8InvalidCard	308
PositionFdbkLoss	96
Power Loss	3
Precharge Open	138
Prev Maint Reset	290
Pri VelFdbk Loss	91
Profiling Active	177
Pump Off	67
PWM FPGA Overrun	380
Port 4 Cfg	244
Port 4 Checksum	264

<b>Fault/Alarm Text</b>	<b>Number</b>
Port 4 Comm Loss	224
Port 4 DPI Loss	84
Port 5 Adapter	75
Port 5 Cfg	245
PWM Freq Reduced	169
Pwr Brd Checksum	104
PwrBd App MinVer	112
PwrBd Invalid ID	111
PwrBd PwrDn Chks	118
PwrDn Data Chksm	117
PwrDn NVS Blank	101
PwrDn NVS Incomp	103
PwrDn Table Full	115
PwrDnEntry2Large	116
Regeneration OK	310
Replaced MCB-PB	107
Rerate See Manual	361
Rev End Limit	182
Rev Spd Lim Cfg	193
Safety Brd Fault	211
Safety Jmpr Out	212
Safety Jumper In	213


<b>Fault/Alarm Text</b>	<b>Number</b>
SafetyPortCnflct	214
Shear Pin 1	61
Shear Pin 2	62
Sleep Config	161
SpdReg DL Err	201
Start On PowerUp	134
SW OverCurrent	36
System Defaulted	48
Task Overrun	19
Torq Prove Cflct	27
TorqPrv Spd Band	20
TP Encls Config	28
Tracking DataErr	113
Travel Lim Cflct	175
Trnsistr OvrTemp	9
UnderVoltage	4
Using Backup App	125
VHz Boost Limit	187
VHz Neg Slope	186
Waking	162
Zero Cnv/Prechrg	365

## Inverter (Port 10) Faults and Alarms (Frame 8 and Larger)

Table 12 contains a list of Inverter-specific faults and alarms, the type of fault or alarm, the action that is taken when the drive faults, the parameter that is used to configure the fault or alarm (if applicable), and a description and action (where applicable). See [Faults, Alarms, and Configurable Conditions](#) for information on the Auto Reset (Auto Reset Run/Restart) and Auto Clear (Auto Reset Clear) columns in this table.


These faults and alarms only apply to Frame 8 drives and larger.

**Table 12 - Inverter Fault and Alarm Types, Descriptions, and Actions**

Event No.	Fault/Alarm Text	Type	Fault Action	Configuration Parameter	Auto Reset	Auto Clear	Description/Action(s)
10101 10201 10301	I1 Comm Loss I2 Comm Loss I3 Comm Loss	Non-Reset Fault	Coast				<p>Indicates that the communication connection from the fiber optic interface board to the power layer interface board has been lost. Once the root cause of the communication fault has been resolved, power must be cycled or a drive reset must be initiated to clear this fault.</p> <ul style="list-style-type: none"> <li>Verify the status of the Fiber Loss pin segment of the power-layer interface board LED.</li> </ul> <hr/> <div style="display: flex; align-items: center;">  <p><b>ATTENTION:</b> Hazard of permanent eye damage exists when using optical transmission equipment. This product emits intense light and invisible radiation. Do not look into fiber-optic ports or fiber-optic cable connectors. Remove power from the drive before disconnecting fiber optic cables.</p> </div> <hr/> <ul style="list-style-type: none"> <li>Verify that the fiber optic cables are properly connected to the transceivers.</li> <li>Verify that the transceivers are properly seated in the ports.</li> <li>Verify that the fiber optic cable is not cracked or broken.</li> <li>Verify that power is applied to the fiber optic interface board and power layer interface board.</li> </ul>
10102 10202 10302	I1 Thermal Const I2 Thermal Const I3 Thermal Const	Non-Reset Fault	Coast				<p>The thermal model data sent to the power layer interface board is incorrect.</p> <ul style="list-style-type: none"> <li>Verify that the inverter is the correct rating for the drive.</li> <li>Compare the firmware revisions of the power layer interface and control board for compatibility.</li> <li>If necessary, reflash the application firmware in control board.</li> </ul>
10103 10203 10303	I1 HSFan Slow I2 HSFan Slow I3 HSFan Slow	Alarm 1					<p>The inverter heatsink fan is running below normal operating speed.</p> <ul style="list-style-type: none"> <li>Verify the actual fan speed in [In HSFan Speed] (Port 10).</li> <li>Check for debris in the fan. If necessary, clean the fan and housing.</li> <li>Check for noise at the fan, indicating motor bearing failure.</li> <li>Verify that the fan power and feedback connections are not loose or disconnected.</li> <li>Replace the fan, if necessary.</li> </ul>

Event No.	Fault/Alarm Text	Type	Fault Action	Configuration Parameter	Auto Reset	Auto Clear	Description/Action(s)						
10104 10204 10304	I1 Overcurr UPos I2 Overcurr UPos I3 Overcurr UPos	Resettable Fault	Coast		Y	Y	An instantaneous overcurrent (IOC) has occurred in the U, V, or W phase, positive or negative leg. <ul style="list-style-type: none"> <li>Reduce the mechanical load.</li> <li>Check the motor and connections.</li> <li>With motor disconnected, run the drive in open loop, in V/Hz mode and check for sufficient output phase-to-phase voltages. If an IOC occurs immediately after restarting the drive, check the appropriate current sensor.</li> <li>Check the power and signal connections to the gate driver board for the phase that is identified, or replace it. The IGBT could also have failed open (and the opposite leg is receiving excess current).</li> </ul>						
10105 10205 10305	I1 Overcurr UNeg I2 Overcurr UNeg I3 Overcurr UNeg												
10106 10206 10306	I1 Overcurr VPos I2 Overcurr VPos I3 Overcurr VPos												
10107 10207 10307	I1 Overcurr VNeg I2 Overcurr VNeg I3 Overcurr VNeg												
10108 10208 10308	I1 Overcurr WPos I2 Overcurr WPos I3 Overcurr WPos												
10109 10209 10309	I1 Overcurr WNeg I2 Overcurr WNeg I3 Overcurr WNeg												
10110 10210 10310	I1 Bus Overvolt I2 Bus Overvolt I3 Bus Overvolt							Resettable Fault	Coast		Y	Y	The DC bus has exceeded the maximum value. <ul style="list-style-type: none"> <li>Verify the correct voltage on the AC input line.</li> <li>Reduce the mechanical load and/or rate of deceleration.</li> <li>Compare the DC bus voltage displayed in [In DC Bus Volt] (port 10), in [Cr DC Bus Volt] (port 11), and with a meter using the DC+ and DC- test points at the top of the inverter. If the measurements do not match, the components that are used for DC bus voltage feedback sensing can be damaged or incorrect. Replace the power supply, power control, and power-layer interface circuit boards.</li> </ul>
10111 10211 10311	I1 Ground Fault I2 Ground Fault I3 Ground Fault							Resettable Fault	Coast		Y	Y	A current path to earth ground greater than 25 % of drive rating has occurred. <ul style="list-style-type: none"> <li>Perform a Megger or surge test on a disconnected motor. Replace the motor, if necessary.</li> <li>Check the output phase current displayed in [In U Phase Curr], [In V Phase Curr], and [In W Phase Curr] (port 10) for an imbalance. [In Gnd Current] (port 10) is the calculated (not measured) ground current based on the phase currents.</li> <li>If the ground fault happens immediately when the drive is started, view the values of the output phase current parameters (noted in the second bullet) when running the drive with a light load or perform a trending analysis.</li> <li>Reseat the rating plug and current transducer wiring harness.</li> </ul>
10112 10212 10312	I1 IGBT OvrTemp I2 IGBT OvrTemp I3 IGBT OvrTemp							Resettable Fault	Coast		Y	Y	An IGBT over temperature has been detected. This power layer interface board calculated this value based on the NTC temperature plus a rise based on recent currents through the inverter. <ul style="list-style-type: none"> <li>Check the NTC temperature that is displayed in [In Heatsink Temp] (port 10) and verify that it is not near the limit. If this value is near the limit, check for cooling problems caused by a blocked or slow heatsink fan.</li> <li>Check the output phase current displayed in [In U Phase Curr], [In V Phase Curr], and [In W Phase Curr] (port 10) for an imbalance.</li> <li>Check for high-current operation at low speeds, since nearly all current goes through one IGBT in this case.</li> <li>Replace the power layer interface board.</li> </ul>
10113 10213 10313	I1 HS OvrTemp I2 HS OvrTemp I3 HS OvrTemp	Resettable Fault	Coast		Y	Y	A heatsink over temperature has occurred in inverter 1. <ul style="list-style-type: none"> <li>Verify that the NTC is not disconnected or shorted.</li> <li>Check for cooling problems - the heatsink cooling fan is running slow, the enclosure filter or heatsink fins are dirty, or the ambient temperature is too high.</li> <li>Check the NTC resistance with a meter. If the resistance is correct, replace the power layer interface board.</li> </ul>						

Event No.	Fault/Alarm Text	Type	Fault Action	Configuration Parameter	Auto Reset	Auto Clear	Description/Action(s)
10114 10214 10314	I1 Main PS Low I2 Main PS Low I3 Main PS Low	Resettable Fault	Coast				<p>The main power supply is producing a low voltage. The inverter power board provides +/- 24V for the stirring fans, LEMs, and floating supply for the gate driver boards. This fault can occur during a power-down sequence.</p> <ul style="list-style-type: none"> <li>If this fault occurs when the drive is started, check the stirring fans for a short.</li> <li>Disconnect the individual loads that are powered by this board and look for a short or excessive current.</li> <li>Replace the inverter power supply board.</li> </ul>
10115 10215 10315	I1 IPwrIF PS Low I2 IPwrIF PS Low I3 IPwrIF PS Low	Resettable Fault	Coast				<p>The local power supply is producing a low voltage. The inverter power supply board generates +/-12V from the system power supply and provides power to the power control and power layer interface (PLI) boards.</p> <ul style="list-style-type: none"> <li>Check for a short on the power layer interface or backplane board and replace as necessary.</li> <li>If no short is present on the power layer interface or backplane board, replace the inverter power board.</li> </ul>
10116 10216 10316	I1 Sys PS Low I2 Sys PS Low I3 Sys PS Low	Alarm 1					<p>A system power supply under voltage has occurred.</p> <ul style="list-style-type: none"> <li>Using a meter, check for 24V on the inverter power supply board. Replace the board if necessary.</li> </ul>
10117 10217 10317	I1 SysPS Overcur I2 SysPS Overcur I3 SysPS Overcur	Resettable Fault	Coast				<p>A system power supply over current has occurred. This fault can occur during a power-down sequence.</p> <ul style="list-style-type: none"> <li>Check the wiring harness from the inverter power supply board to the converter gate firing board and control pod for shorts/reversals.</li> <li>Check for a short on incoming power to the converter gate firing board or fiber interface board.</li> <li>Disconnect P6 on the inverter power board to remove the load from this power supply. If the breaker remains tripped, replace the inverter power supply board.</li> </ul>
10118 10218 10318	I1 HSFan PS Low I2 HSFan PS Low I3 HSFan PS Low	Alarm 1					<p>A heatsink fan power-supply undervoltage has occurred.</p> <ul style="list-style-type: none"> <li>Check for 230V supply on the inverter power supply board at connector P6. If there is voltage, replace the inverter power supply board.</li> <li>If there is no voltage, check the control power transformer, its primary and secondary fuses, and wiring harness.</li> </ul>
10119 10219 10319	I1 CT Harness I2 CT Harness I3 CT Harness	Non-Reset Fault	Coast				<p>The drive has detected a connection loss to a current transducer.</p> <ul style="list-style-type: none"> <li>Verify that the current transducer wiring harness is connected to J22, J23, and J24 on the power interface board.</li> </ul>
10120 10220 10320	I1 PLI OvrTemp I2 PLI OvrTemp I3 PLI OvrTemp	Resettable Fault	Coast		Y	Y	<p>The power-layer interface circuit board is over temperature.</p> <ul style="list-style-type: none"> <li>Verify that the ambient temperature is not too high.</li> <li>Verify that the stirring fans are operational.</li> <li>Check the temperature sensor test point on the power layer interface board to verify that the output is within range. If necessary, replace the power layer interface board.</li> </ul>
10121 10221 10321	I1 PSBrd OvrTemp I2 PSBrd OvrTemp I3 PSBrd OvrTemp	Resettable Fault	Coast		Y	Y	<p>The power supply board is over temperature.</p> <ul style="list-style-type: none"> <li>Verify that the ambient temperature is not too high.</li> <li>Verify that the stirring fans are operational.</li> <li>Check the temperature sensor test point on the power layer interface board to verify that the output is within range. The temperature sensor is on the inverter power supply board but the A/D processing is on the power layer interface board. If necessary, replace the inverter power supply board. If this problem persists after replacing the inverter power supply board, replace the power layer interface board.</li> </ul>
10122 10222 10322	I1 InFan1 Slow I2 InFan1 Slow I3 InFan1 Slow	Alarm 1 / Resettable Fault					<p>Stirring fan 1 is under speed.</p> <ul style="list-style-type: none"> <li>Visually verify that fan 1 is turning.</li> <li>Check the measured fan speed displayed in [In InFan n Speed] (port 10).</li> <li>Check the wiring harness to the stirring fans to verify that the power and tachometer signals are connected.</li> <li>If necessary, replace both stirring fans. When the fans are replaced, the elapsed hours, displayed in [In PredMainReset] (port 10) must be reset.</li> </ul>
10123 10223 10323	I1 InFan2 Slow I2 InFan2 Slow I3 InFan2 Slow						

Event No.	Fault/Alarm Text	Type	Fault Action	Configuration Parameter	Auto Reset	Auto Clear	Description/Action(s)
10124 10224 10324	I1 NTC Open I2 NTC Open I3 NTC Open	Non-Reset Fault	Coast				<p>An NTC open condition has occurred.</p> <ul style="list-style-type: none"> <li>• Check the ribbon cable that runs between the backplane board and gate driver board for loose connections or damage. The capacitor bank must be removed to check this cable.</li> <li>• If the drive is located in cold conditions, raise the ambient temperature.</li> <li>• Check the power-layer interface board testpoints for the individual phase NTC temperatures to determine which is open.</li> <li>• Reseat the power layer interface board. If this problem persists, replace the power layer interface board.</li> </ul>
10125 10225 10325	I1 Incompat UBrd I2 Incompat UBrd I3 Incompat UBrd	Non-Reset Fault	Coast				<p>The power layer interface and power control board do not detect the correct gate driver board on the U, V, or W phase. This fault can occur during a power-down sequence.</p> <ul style="list-style-type: none"> <li>• Check the ribbon cable that runs between the backplane board and gate driver board for loose connections or damage and verify that the correct gate driver board is installed. The capacitor bank must be removed to check this cable and the board.</li> <li>• Reflash the control board.</li> <li>• Check the rating plug.</li> </ul>
10126 10226 10326	I1 Incompat VBrd I2 Incompat VBrd I3 Incompat VBrd						
10127 10227 10327	I1 Incompat WBrd I2 Incompat WBrd I3 Incompat WBrd						
10128 10228 10328	I1 Incompat Brdn I2 Incompat Brdn I3 Incompat Brdn						
10129 10229 10329	I1 DC Bus Imbal I2 DC Bus Imbal I3 DC Bus Imbal	Resettable Fault	Coast				<p>Either the lower or upper leg of the capacitor bank is getting too much voltage (based on the bus voltage, measured voltage across the lower leg, and a calculation to find the voltage across the upper leg) or the voltage sensing components are damaged.</p> <ul style="list-style-type: none"> <li>• Check the value of the bus bleeder resistor and bus balancing resistor and replace as necessary.</li> <li>• Inspect the capacitor bank for leakage or damage and replace as necessary. Replacing the capacitor bank assembly also replaces the bus balancing resistor.</li> </ul> <hr/> <div style="display: flex; align-items: center;">  <p><b>ATTENTION:</b> The DC bus voltage can only be measured when the drive is energized. Servicing energized equipment can be hazardous. Severe injury or death can result from electrical shock, burn, or unintended actuation of controlled equipment. Follow Safety related practices of NFPA 70E, ELECTRICAL SAFETY FOR EMPLOYEE WORKPLACES. DO NOT work alone on energized equipment!</p> </div> <hr/> <ul style="list-style-type: none"> <li>• Measure the voltage on each half of the bus to confirm the calculations. If the bus measurements aren't correct, replace the power interface board and/or inverter power supply board.</li> </ul>
10130 10230 10330	I1 Curr Offset I2 Curr Offset I3 Curr Offset	Alarm 1					<p>The calculated current offset for any phase is larger than expected.</p> <ul style="list-style-type: none"> <li>• Check the current sensor offset reading inverter testpoint and power supply. If necessary, replace the current sensor.</li> <li>• If this problem persists, replace the inverter power supply board and/or the power layer interface board.</li> </ul>
10131 10231 10331	I1 Fault Q Full I2 Fault Q Full I3 Fault Q Full	Resettable Fault	Coast				<p>The fault queue is full. There are at least three other faults in the queue. Troubleshooting and clearing the existing faults makes room for additional faults in the queue (if any). This fault can occur during a power-down sequence.</p>

Event No.	Fault/Alarm Text	Type	Fault Action	Configuration Parameter	Auto Reset	Auto Clear	Description/Action(s)
10132 10232 10332	I1 Incompat PS I2 Incompat PS I3 Incompat PS	Resettable Fault	Coast				The drive has detected an incompatible power supply for the drive AC input rating. <ul style="list-style-type: none"> <li>• Check the power supply and replace it if incorrect.</li> <li>• If the power supply is correct, reflash the control board.</li> <li>• If this problem persists, replace the inverter power supply board or power layer interface board.</li> </ul>
10134 10234 10334 10135 10235 10335 10136 10236 10336	I1 UBrd Fault I2 UBrd Fault I3 UBrd Fault I1 VBrd Fault I2 VBrd Fault I3 VBrd Fault I1 WBrd Fault I2 WBrd Fault I3 WBrd Fault	Resettable Fault	Coast				The power supply on the U, V, or W phase gate driver board has failed. <ul style="list-style-type: none"> <li>• If this fault occurred on this phase only, replace the appropriate gate driver board.</li> <li>• If this fault occurred on all three phases, check the 24V power supply on the inverter power supply board that feeds the gate driver boards and replace the inverter power supply board if necessary.</li> </ul>
10137 10237 10337	I1 Flash Failed I2 Flash Failed I3 Flash Failed	Resettable Fault	Coast				This fault will be asserted if an attempt to flash the FPGA configuration device fails.
10138 10238 10338	I1 Powering Down I2 Powering Down I3 Powering Down	Resettable Fault	Coast				This fault will be asserted at 80% of the rated DC bus voltage.




## Converter (Port 11) Faults and Alarms (Frame 8 and Larger)

Table 13 contains a list of Converter-specific faults and alarms, the type of fault or alarm, the action that is taken when the drive faults, the parameter that is used to configure the fault or alarm (if applicable), and a description and action (where applicable). See [Faults, Alarms, and Configurable Conditions](#) for information on the Auto Reset (Auto Reset Run/Restart) and Auto Clear (Auto Reset Clear) columns in this table. These faults and alarms only apply to Frame 8 drives and larger.

**Table 13 - Converter Fault and Alarm Types, Descriptions, and Actions**

Event No.	Fault/Alarm Text	Type	Fault Action	Configuration Parameter	Auto Reset	Auto Clear	Description/Action(s)						
11101 11201 11301	C1 Precharge C2 Precharge C3 Precharge	Alarm 1 Non-Reset Fault	Coast				<p>1. The AC line voltage is in the range of 50...300V (for 400V class drives) or 50...400V (for 600V class drives). Precharge begins when the AC line voltage reaches 300V or 400V.</p> <p>2. The drive has been in precharge for more than 12 seconds. If the “Cn Precharge” alarm persists for more than 30 seconds the drive will fault. Following powerup or a fault reset, the converter does not issue any voltage-related alarms until the AC input voltage exceeds 50V to prevent an alarm when a customer-supplied auxiliary power supply is used.</p> <p>3. The DC bus open circuit test can be cycling. If this test cycles for more than 10 seconds, event 144/244 “Cn DC Bus Open” occurs.</p> <p>Alarm:</p> <ul style="list-style-type: none"> <li>Check the line voltage displayed in [Cn L12 Line Volt], [Cn L23 Line Volt], and [CV L31 Line Volt] (port 11).</li> <li>Check the phase current displayed in [Cn L1 Phase Curr], [Cn L2 Phase Curr], and [Cn L3 Phase Curr] (port 11) and the bus voltage in [Cn DC Bus Volt] (port 11). Line current, line voltage, and bus voltage sensing are all performed on the converter gate firing board. If this alarm persists, replace the converter gate firing board.</li> </ul> <p>Fault:</p> <ul style="list-style-type: none"> <li>Verify that the current transducers have not all failed. If necessary, replace all three current transducers.</li> <li>Verify that the DC link inductor has not failed. If necessary, replace the DC link choke.</li> <li>Verify that the converter line and DC bus wiring is connected.</li> <li>Verify that the capacitor bank is properly installed and connected.</li> </ul>						
11102 11202 11302	C1 Phase Loss L1 C2 Phase Loss L1 C3 Phase Loss L1	Alarm 1					<p>The AC line-to-line voltages are imbalanced, indicating an open AC input phase.</p> <ul style="list-style-type: none"> <li>Check for an upstream AC line loss.</li> <li>Verify that the AC input line wiring is properly connected.</li> <li>Check the wiring harness to the converter gate firing board for loose connections and/or damage. If necessary, replace the converter gate-firing board wiring harness.</li> </ul>						
11103 11203 11303	C1 Phase Loss L2 C2 Phase Loss L2 C3 Phase Loss L2												
11104 11204 11304	C1 Phase Loss L3 C2 Phase Loss L3 C3 Phase Loss L3												
11111 11211 11311	C1 SCR OvrTemp C2 SCR OvrTemp C3 SCR OvrTemp							Resettable Fault	Coast		Y	Y	<p>An alarm occurs if the calculated SCR temperature exceeds 125 °C (257 °F) and a fault occurs when the calculated SCR temperature exceeds 135 °C (275 °F).</p> <ul style="list-style-type: none"> <li>Check for cooling problems - the heatsink cooling fan is running slow, the enclosure filter or heatsink fins are dirty, or the ambient temperature is too high.</li> </ul>
11112 11212 11312	C1 HS OvrTemp C2 HS OvrTemp C3 HS OvrTemp							Resettable Fault	Coast		Y	Y	<p>An alarm when the heatsink temperature exceeds 95 °C (203 °F) and a fault when the heatsink temperature exceeds 100 °C (212 °F).</p> <ul style="list-style-type: none"> <li>Check the NTC for a short or verify that it is connected.</li> <li>Measure the resistance of the NTC. The reading should be approximately 11.5 Ω, at room temperature.</li> <li>Check for cooling problems - the heatsink cooling fan is running slow, the enclosure filter or heatsink fins are dirty, or the ambient temperature is too high.</li> </ul>

Event No.	Fault/Alarm Text	Type	Fault Action	Configuration Parameter	Auto Reset	Auto Clear	Description/Action(s)
11113 11213 11313	C1 TVSS Blown C2 TVSS Blown C3 TVSS Blown	Alarm 1					<p>The MOV block is reporting that the transient voltage suppression system (TVSS) has blown.</p> <ul style="list-style-type: none"> <li>Check the MOV wiring harness for loose connections and/or damage and replace if necessary.</li> <li>Replace the MOV block.</li> <li>If the MOV block is not blown and the wiring harness is properly connected and not damaged, replace the converter gate firing board.</li> </ul>
11114 11214 11314	C1 Blower Speed C2 Blower Speed C3 Blower Speed	Alarm 1					<p>The converter cooling fan is running below normal operating speed.</p> <ul style="list-style-type: none"> <li>Check for debris in the fan. If necessary, clean the fan and housing.</li> <li>Check for noise at the fan, indicating motor bearing failure.</li> <li>Verify that the fan power and feedback connections are not loose or disconnected.</li> <li>Replace the fan, if necessary.</li> </ul>
11115 11215 11315	C1 Line Dip C2 Line Dip C3 Line Dip	Alarm 1 Resetable Fault	Coast		Y	Y	<p>The bus voltage has fallen below the value specified in P451 [Pwr Loss A Level] or P454 [Pwr Loss B Level] (port 0) minus 20 volts. Until the converter has established communications with the main control board, this value defaults to 180V below the converter bus memory. The converter stops firing the SCRs until the nominal value of the DC bus voltage for the present AC line voltage is within 60 volts of P12 [DC Bus Memory] (port 0). If the line dip condition persists for more than 60 seconds the alarm becomes a fault.</p> <ul style="list-style-type: none"> <li>Verify the power wiring connections.</li> <li>Compare the actual DC bus voltage to the value displayed in [Cr DC Bus Volt]. If the values are different, replace the converter gate firing board.</li> </ul>
11116 11216 11316	C1 Minimum Line C2 Minimum Line C3 Minimum Line	Alarm 1					<p>The AC line voltage is less than 280V (for a 400V class drive) / 400V (for a 600V class drive).</p> <ul style="list-style-type: none"> <li>The AC line voltage must exceed 320V / 440V to recover from this alarm.</li> </ul>
11117 11217 11317	C1 Line Freq C2 Line Freq C3 Line Freq	Alarm 1 Resetable Fault	Coast				<p>The measured line frequency is out of the range (below 40 Hz, or above 65 Hz). This alarm becomes a fault if the condition persists for more than 30 seconds.</p> <ul style="list-style-type: none"> <li>Check the incoming power line frequency.</li> <li>Check the wiring harness to the converter gate firing board for loose connections and/or damage and replace if necessary.</li> <li>If the wiring harness is properly connected and not damaged, replace the converter gate firing board.</li> </ul>
11118 11218 11318	C1 Single Phase C2 Single Phase C3 Single Phase	Alarm 1 Resetable Fault	Coast				<p>The converter was intentionally powered up in single-phase mode with only AC phase L1-L2 present. Intentional single-phase mode is only detected at the initial application of AC line voltage. Application of 3-phase voltage after the converter has entered single-phase mode results in the single phase alarm becoming a fault.</p> <ul style="list-style-type: none"> <li>Verify that only one phase is applied to a drive in single-phase mode.</li> </ul>
11134 11234 11334	C1 Overcurrent C2 Overcurrent C3 Overcurrent	Resetable Fault	Coast				<p>The peak AC input current has exceeded 3000 A for five line cycles.</p> <ul style="list-style-type: none"> <li>Verify that the current transducers are connected.</li> <li>Check the wiring harness to the converter gate firing board for loose connections or damage and replace if necessary.</li> <li>If the current transducers are properly connect and the wiring harness for the gate firing board is OK, replace the converter gate firing board.</li> <li>Check for an open SCR or DC bus short.</li> </ul>
11135 11235 11335	C1 Ground Fault C2 Ground Fault C3 Ground Fault	Resetable Fault	Coast		Y	Y	<p>The converter input ground current (peak) has exceeded the threshold set P16 [Gnd Cur Flt Lvl] (port 11) for 5 line cycles. A possible internal short in the drive between a phase, ground, or the DC bus can have occurred.</p> <ul style="list-style-type: none"> <li>Verify that the current transducer wiring harness is connected to the converter gate firing board and that they are functioning properly. If necessary, replace all three current transducers (CTs).</li> <li>If the current transducer wiring harness is connected and the CTs are functioning properly, replace the converter gate firing board.</li> <li>To determine if there is an imbalance between the phases, view the input phase current values in [Cr L1 Phase Curr], [Cr L2 Phase Curr], and [Cr L3 Phase Curr] (port 11). [Cr Gnd Current] (port 11) is the calculated (not measured) ground current based on the phase currents. If necessary, use trending when the ground fault occurs upon drive power-up.</li> </ul>

Event No.	Fault/Alarm Text	Type	Fault Action	Configuration Parameter	Auto Reset	Auto Clear	Description/Action(s)
11136 11236 11336	C1 HS NTC Open C2 HS NTC Open C3 HS NTC Open	Non-Reset Fault	Coast				<p>The converter heatsink NTC is open. The heatsink NTC is mounted on the converter heatsink and is wired to the converter gate firing board. An open NTC is assumed when the heatsink temperature is below <math>-40^{\circ}\text{C}</math> (<math>-40^{\circ}\text{F}</math>).</p> <ul style="list-style-type: none"> <li>Check for loose connections or damage to the NTC wiring harness.</li> <li>Measure the resistance of the NTC and verify that it is within range.</li> <li>If the NTC wiring harness and resistance measurement is OK, replace the converter gate firing board.</li> </ul>
11137 11237 11337	C1 HS NTC Short C2 HS NTC Short C3 HS NTC Short	Non-Reset Fault	Coast				<p>The converter heatsink NTC is shorted. The heatsink NTC is mounted on the converter heatsink and is wired to the converter gate firing board. A shorted NTC is assumed when the heatsink temperature is above <math>200^{\circ}\text{C}</math> (<math>392^{\circ}\text{F}</math>).</p> <ul style="list-style-type: none"> <li>Check for loose connections or damage to the NTC wiring harness.</li> <li>Measure the resistance of the NTC and verify that it is within range.</li> <li>If the NTC wiring harness and resistance measurement is OK, replace the converter gate firing board.</li> </ul>
11138 11238 11338	C1 Brd OvrTemp C2 Brd OvrTemp C3 Brd OvrTemp	Resettable Fault	Coast		Y	Y	<p>The gate firing board is over temperature. This fault occurs when the gate firing board temperature exceeds <math>70^{\circ}\text{C}</math> (<math>158^{\circ}\text{F}</math>).</p> <ul style="list-style-type: none"> <li>Check the cabinet fan wiring harness for loose connections or damage and that the fan is running. If necessary, replace the fan wiring harness and/or fan.</li> <li>Lower the ambient temperature.</li> <li>Replace the converter gate firing board.</li> </ul>
11139 11239 11339	C1 Brd NTC Open C2 Brd NTC Open C3 Brd NTC Open	Non-Reset Fault	Coast				<p>The converter gate firing board NTC is open. An open NTC is assumed when the temperature is below <math>-40^{\circ}\text{C}</math> (<math>-40^{\circ}\text{F}</math>).</p> <ul style="list-style-type: none"> <li>Replace the converter gate firing board.</li> </ul>
11140 11240 11340	C1 Brd NTC Short C2 Brd NTC Short C3 Brd NTC Short	Non-Reset Fault	Coast				<p>The converter gate firing board NTC is shorted. A shorted NTC is assumed when the temperature is above <math>200^{\circ}\text{C}</math> (<math>392^{\circ}\text{F}</math>).</p> <ul style="list-style-type: none"> <li>Replace the converter gate firing board.</li> </ul>
11141 11241 11341	C1 Power Supply C2 Power Supply C3 Power Supply	Resettable Fault	Coast				<p>A power supply input voltage (24V input and/or <math>\pm 12\text{V}</math> internal supply) is operating outside of the acceptable range.</p> <ul style="list-style-type: none"> <li>Check input power to the converter gate firing board. The following thresholds are used:                             <ul style="list-style-type: none"> <li>24V is below 20.1V</li> <li>12V is below 10.0V</li> <li>12V is above 15.0V</li> <li>-12V is above -10.0V</li> </ul> </li> <li>If the power supply voltage is within the acceptable range, replace the converter gate firing board.</li> </ul>
11142 11242 11342	C1 Comm Loss C2 Comm Loss C3 Comm Loss	Resettable Fault	Coast				<p>The converter gate firing board lost communications (through the power layer interface board) to the main control board. Once the root cause of the communication fault has been resolved, power must be cycled or a drive reset must be initiated to clear this fault.</p> <hr/> <div style="display: flex; align-items: center;">  <div style="margin-left: 10px;"> <p><b>ATTENTION:</b> Hazard of permanent eye damage exists when using optical transmission equipment. This product emits intense light and invisible radiation. Do not look into fiber-optic ports or fiber-optic cable connectors. Remove power from the drive before disconnecting fiber optic cables.</p> </div> </div> <hr/> <ul style="list-style-type: none"> <li>Verify that the fiber optic cables are properly connected to the transceivers.</li> <li>Verify that the transceivers are properly seated in the ports.</li> <li>Verify that the fiber optic cable is not cracked or broken.</li> <li>Verify that power is applied to the fiber optic interface board, gate firing board, and power layer interface board. If necessary, replace the fiber optic interface, gate firing board, and/or power layer interface board.</li> </ul>
11143 11243 11343	C1 Firmware Flt C2 Firmware Flt C3 Firmware Flt	Non-Reset Fault	Coast				<p>A firmware fault has occurred.</p> <ul style="list-style-type: none"> <li>Reset the drive. If this fault persists, replace the converter gate firing board.</li> </ul>

Event No.	Fault/Alarm Text	Type	Fault Action	Configuration Parameter	Auto Reset	Auto Clear	Description/Action(s)
11144 11244 11344	C1 DC Bus Open C2 DC Bus Open C3 DC Bus Open	Non-Reset Fault	Coast				<p>The DC bus voltage did not rise above 12V (for 400V class drives) or 20V (for 600V class drives) as the SCRs began to ramp on. In this case, the converter tries to turn on the SCRs for approximately 10 seconds before issuing this fault. Event 101/201 "C<sub>n</sub> Precharge" is issued following the first retry.</p> <ul style="list-style-type: none"> <li>Verify that the current transducers have not all failed. If necessary, replace all three current transducers.</li> <li>Verify that the DC link inductor has not failed. If necessary, replace the DC link choke.</li> <li>Verify that the converter line and DC bus wiring is connected.</li> <li>Verify that the capacitor bank is properly installed and connected.</li> </ul>
11145 11245 11345	C1 DC Bus Short C2 DC Bus Short C3 DC Bus Short	Non-Reset Fault	Coast				<p>The peak current has exceeded 150 % of the converter rating during the precharge sequence. Peak charging current is normally limited to 50 % of the converter rating.</p> <ul style="list-style-type: none"> <li>Check for a DC bus short, internally and externally.</li> <li>Verify that the wiring harness to P10 on the converter gate firing board is connected and not damaged. Replace the harness as necessary.</li> <li>Verify that the capacitor bank is properly installed and connected.</li> <li>Check for an IGBT short and replace as necessary.</li> </ul>
11146 11246 11346	C1 CT Harness C2 CT Harness C3 CT Harness	Non-Reset Fault	Coast				<p>A current transducer (CT) wiring harness connection loss has been detected.</p> <ul style="list-style-type: none"> <li>Verify that the CT wiring harness is not damaged and is connected to P6 on the converter gate firing board. Replace the wiring harness if necessary.</li> <li>If this problem persists, replace the converter gate firing board.</li> </ul>
11147 11247 11347	C1 LFuse Harness C2 LFuse Harness C3 LFuse Harness	Non-Reset Fault	Coast				<p>A line-fuse wiring harness connection loss has been detected.</p> <ul style="list-style-type: none"> <li>Verify that the line fuse wiring harness is not damaged and is connected to P7 on the converter gate firing board. Replace the wiring harness if necessary.</li> <li>If this problem persists, replace the converter gate firing board.</li> </ul>
11148 11248 11348 11149 11249 11349 11150 11250 11350	C1 Line Fuse L1 C2 Line Fuse L1 C3 Line Fuse L1 C1 Line Fuse L2 C2 Line Fuse L2 C3 Line Fuse L2 C1 Line Fuse L3 C2 Line Fuse L3 C3 Line Fuse L3	Non-Reset Fault	Coast				<p>The line fuse for Line <i>n</i> has blown.</p> <ul style="list-style-type: none"> <li>Check the fuse and replace if necessary.</li> <li>Verify that the line fuse wiring harness for line 1 is not damaged and is connected to P7 on the converter gate firing board. Replace the wiring harness if necessary.</li> <li>If this problem persists, replace the converter gate firing board.</li> </ul>
11157 11257 11357	C1 BFuse Harness C2 BFuse Harness C3 BFuse Harness	Non-Reset Fault	Coast				<p>A bus-fuse wiring harness connection loss has been detected.</p> <ul style="list-style-type: none"> <li>Check the bus fuse harness and replace if necessary.</li> <li>If this problem persists, replace the converter gate firing board.</li> </ul>
11158 11258 11358	C1 BFuse Pos C2 BFuse Pos C3 BFuse Pos	Non-Reset Fault	Coast				<p>The DC+ bus fuse is blown.</p> <ul style="list-style-type: none"> <li>Check the DC+ bus fuse and wiring harness and replace if necessary.</li> <li>If this problem persists, replace the converter gate firing board.</li> </ul>
11159 11259 11359	C1 BFuse Neg C2 BFuse Neg C3 BFuse Neg	Non-Reset Fault	Coast				<p>The DC- bus fuse is blown.</p> <ul style="list-style-type: none"> <li>Check the DC- bus fuse and wiring harness and replace if necessary.</li> <li>If this problem persists, replace the converter gate firing board.</li> </ul>
11160 11260 11360	C1 Command Stop C2 Command Stop C3 Command Stop	Resettable Fault	Coast		Y	Y	<p>The main control board has commanded the converter gate firing board to stop due to an asymmetrical bus condition.</p> <ul style="list-style-type: none"> <li>Check the DC bus connections and wiring.</li> </ul>


Event No.	Fault/Alarm Text	Type	Fault Action	Configuration Parameter	Auto Reset	Auto Clear	Description/Action(s)
11161 11261 11361	C1 AC Line High C2 AC Line High C3 AC Line High	Resettable Fault	Coast				The AC line voltage has exceeded 565V (for 400V class drives) or 815V (for 600V class drives), which corresponds to the nominal bus voltage of 799V DC (for 400V class drives) or 1150V DC (for 600V class drives). This fault is intended to protect the capacitor bank from an overvoltage condition especially if a 400V class drive is inadvertently placed in a 600V system. <ul style="list-style-type: none"> <li>Verify the incoming line voltage.</li> </ul>
11162 11262 11362	C1 Line Loss C2 Line Loss C3 Line Loss	Resettable Fault	Coast		Y	Y	An AC line loss has occurred. <ul style="list-style-type: none"> <li>Monitor the incoming AC line for low voltage or line power interruption.</li> </ul>
11163 11263 11363	C1 Fault Q Full C2 Fault Q Full C3 Fault Q Full	Resettable Fault	Coast				The fault queue is full. There are at least three other faults in the queue. <ul style="list-style-type: none"> <li>Troubleshooting and clearing the existing faults make room for additional faults in the queue (if any).</li> </ul>

## Precharge (Port 11) Faults and Alarms (Frame 8 and Larger)

Table 14 contains a list of Precharge-specific faults and alarms, the type of fault or alarm, the action that is taken when the drive faults, the parameter that is used to configure the fault or alarm (if applicable), and a description and action (where applicable). See [Faults, Alarms, and Configurable Conditions](#) for information on the Auto Reset (Auto Reset Run/Restart) and Auto Clear (Auto Reset Clear) columns in this table. These faults and alarms only apply to Frame 8 drives and larger.

**Table 14 - Converter Fault and Alarm Types, Descriptions, and Actions**

Event No.	Fault/Alarm Text	Type	Fault Action	Configuration Parameter	Auto Reset	Auto Clear	Description/Action(s)
11101 11201 11301	P1 Precharge P2 Precharge P3 Precharge	Alarm 1					The DC bus delta voltage (Vbus_in - Vbus_out) is greater than 25V when the molded case switch (MCS) is open. This alarm is suppressed when the Precharge Fault is present.
		Resettable Fault	Coast				The DC bus voltage did not meet the conditions that are required to close the molded case switch (MCS) within the timeout period. 1. DC bus input is not overvoltage 2. DC bus input is not undervoltage 3. DC bus delta voltage (Vbus_in - Vbus_out) is less than 25V
11115 11215 11315	P1 Bus Dip P2 Bus Dip P3 Bus Dip	Alarm 1					Only occurs when the drive is offline or in stand-alone mode. The bus voltage has dipped more than 180V below the drive bus memory. The alarm is released when the bus voltage rises back to within 60V of the drive bus memory.
11119 11219 11319	P1 240 V AC Loss P2 240 V AC Loss P3 240 V AC Loss	Alarm 1					240V AC not present while the drive is in the inactive state. This alarm is suppressed when the 240V AC Loss Fault is present.
		Resettable Fault	Coast				240V AC was lost while in the active state. Active state whenever the drive is not stopped, for example, the molded case switch (MCS) is opening or closing or is closed.
11120 11220 11320	P1 240V AC Discon P2 240V AC Discon P3 240V AC Discon	Alarm 1					The 240V AC disconnect is open when the precharge controller is in the ready state (MCS is not closed).
11121 11221 11321	P1 Bus Undervolt P2 Bus Undervolt P3 Bus Undervolt	Alarm 1					The input bus voltage is below 400V DC while the molded case switch (MCS) is open. Hysteresis level 420V DC. This alarm is suppressed when the Bus Undervoltage Fault is present.
		Resettable Fault	Coast				The bus input voltage fell below 400V while the molded case switch (MCS) was closed. Hysteresis level at 420V. The system SMPS cuts out near 340V DC.
11122 11222 11322	P1 Bus Overvolt P2 Bus Overvolt P3 Bus Overvolt	Alarm 1					The input bus voltage exceeds 820V DC. Hysteresis level 800V DC.
11123 11223 11323	P1 Door Open P2 Door Open P3 Door Open	Alarm 1					Door closure contact is open.
11130 11230 11330	P1 MCS ShuntTrip P2 MCS ShuntTrip P3 MCS ShuntTrip	Resettable Fault	Coast				The molded case switch (MCS) auxiliary contact did not open within 1 second following the shunt trip coil activation.
11131 11231 11331	P1 MCS CloseFail P2 MCS CloseFail P3 MCS CloseFail	Resettable Fault	Coast				The molded case switch (MCS) auxiliary contact did not close within 2 seconds following the close coil activation.
11132 11232 11332	P1 MCSAuxContact P2 MCSAuxContact P3 MCSAuxContact	Resettable Fault	Coast				The molded case switch (MCS) auxiliary contact was open when the MCS was closed or closed when the MCS was open. If the MCS Failed to Close Fault is present, then this fault is not reported.
11133 11233 11333	P1 MCS Closed P2 MCS Closed P3 MCS Closed	Resettable Fault	Coast				The voltage across the molded case switch (MCS) when it was closed exceeded 10V.

Event No.	Fault/Alarm Text	Type	Fault Action	Configuration Parameter	Auto Reset	Auto Clear	Description/Action(s)
11138 11238 11338	P1 Brd Overtemp P2 Brd Overtemp P3 Brd Overtemp	Resettable Fault	Coast		Y	Y	<p>The gate firing board is over temperature. This fault occurs when the gate firing board temperature exceeds 70 °C (158 °F).</p> <ul style="list-style-type: none"> <li>Check the cabinet fan wiring harness for loose connections or damage and that the fan is running. If necessary, replace the fan wiring harness and/or fan.</li> <li>Lower the ambient temperature.</li> <li>Replace the converter gate firing board.</li> </ul>
11139 11239 11339	P1 Brd NTC Open P2 Brd NTC Open P3 Brd NTC Open	Non-Reset Fault	Coast				<p>The converter gate firing board NTC is open. An open NTC is assumed when the temperature is below -40 °C (-40 °F).</p> <ul style="list-style-type: none"> <li>Replace the converter gate firing board.</li> </ul>
11140 11240 11340	P1 Brd NTC Short P2 Brd NTC Short P3 Brd NTC Short	Non-Reset Fault	Coast				<p>The converter gate firing board NTC is shorted. A shorted NTC is assumed when the temperature is above 200 °C (392 °F).</p> <ul style="list-style-type: none"> <li>Replace the converter gate firing board.</li> </ul>
11141 11241 11341	P1 Power Supply P2 Power Supply P3 Power Supply	Resettable Fault	Coast				<p>A power supply input voltage (24V input and/or +/-12V internal supply) is operating outside of the acceptable range.</p> <ul style="list-style-type: none"> <li>Check input power to the converter gate firing board. The following thresholds are used:                             <ul style="list-style-type: none"> <li>24V is below 20.1V</li> <li>12V is below 10.0V</li> <li>12V is above 15.0V</li> <li>-12V is above -10.0V</li> </ul> </li> <li>If the power supply voltage is within the acceptable range, replace the converter gate firing board.</li> </ul>
11142 11242 11342	P1 Comm Loss P2 Comm Loss P3 Comm Loss	Resettable Fault	Coast				<p>The converter gate firing board lost communications (through the power layer interface board) to the main control board. Once the root cause of the communication fault has been resolved, power must be cycled or a drive reset must be initiated to clear this fault.</p> <div style="border: 1px solid black; padding: 5px; margin: 10px 0;">  <p><b>ATTENTION:</b> Hazard of permanent eye damage exists when using optical transmission equipment. This product emits intense light and invisible radiation. Do not look into fiber-optic ports or fiber-optic cable connectors. Remove power from the drive before disconnecting fiber-optic cables.</p> </div> <ul style="list-style-type: none"> <li>Verify that the fiber optic cables are properly connected to the transceivers.</li> <li>Verify that the transceivers are properly seated in the ports.</li> <li>Verify that the fiber optic cable is not cracked or broken.</li> <li>Verify that power is applied to the fiber optic interface board, gate firing board, and power layer interface board. If necessary, replace the fiber optic interface, gate firing board, and/or power layer interface board.</li> </ul>
11143 11243 11343	P1 Firmware Flt P2 Firmware Flt P3 Firmware Flt	Non-Reset Fault	Coast				<p>A firmware fault has occurred.</p> <ul style="list-style-type: none"> <li>Reset the drive. If this fault persists, replace the converter gate firing board.</li> </ul>
11145 11245 11345	P1 DC Bus Short P2 DC Bus Short P3 DC Bus Short	Non-Reset Fault	Coast				<p>The peak current has exceeded 150 % of the converter rating during the precharge sequence. Peak charging current is normally limited to 50 % of the converter rating.</p> <ul style="list-style-type: none"> <li>Check for a DC bus short, internally and externally.</li> <li>Verify that the wiring harness to P10 on the converter gate firing board is connected and not damaged. Replace the harness as necessary.</li> <li>Verify that the capacitor bank is properly installed and connected.</li> <li>Check for an IGBT short and replace as necessary.</li> </ul>
11157 11257 11357	P1 BFuse Harness P2 BFuse Harness P3 BFuse Harness	Non-Reset Fault	Coast				<p>A bus-fuse wiring harness connection loss has been detected.</p> <ul style="list-style-type: none"> <li>Check the bus fuse harness and replace if necessary.</li> <li>If this problem persists, replace the converter gate firing board.</li> </ul>

Event No.	Fault/Alarm Text	Type	Fault Action	Configuration Parameter	Auto Reset	Auto Clear	Description/Action(s)
11158 11258 11358	P1 BFuse Pos P2 BFuse Pos P3 BFuse Pos	Non-Reset Fault	Coast				The DC+ bus fuse is blown. <ul style="list-style-type: none"> <li>Check the DC+ bus fuse and wiring harness and replace if necessary.</li> <li>If this problem persists, replace the converter gate firing board.</li> </ul>
11159 11259 11359	P1 BFuse Neg P2 BFuse Neg P3 BFuse Neg	Non-Reset Fault	Coast				The DC- bus fuse is blown. <ul style="list-style-type: none"> <li>Check the DC- bus fuse and wiring harness and replace if necessary.</li> <li>If this problem persists, replace the converter gate firing board.</li> </ul>
11160 11260 11360	P1 Command Stop P2 Command Stop P3 Command Stop	Resettable Fault	Coast		Y	Y	The main control board has commanded the converter gate firing board to stop due to an asymmetrical bus condition. <ul style="list-style-type: none"> <li>Check the DC bus connections and wiring.</li> </ul>
11163 11263 11363	P1 Fault Q Full P2 Fault Q Full P3 Fault Q Full	Resettable Fault	Coast				The fault queue is full. There are at least three other faults in the queue. <ul style="list-style-type: none"> <li>Troubleshooting and clearing the existing faults make room for additional faults in the queue (if any).</li> </ul>



## N-1 and Re-Rate Functions

The N-1 feature is available on Frame 9 and larger drives. This feature allows the drive to be run at reduced current limits if one of the paralleled inverter/converter drive assemblies fails.

The letter N represents the number of drive assemblies in the drive. For example, a frame 9 drive has two drive assemblies, therefore  $N=2$ . A Frame 9 drive running the N-1 feature is running on one drive assembly, that is,  $N-1 = 1$ .

The N-1 feature does not change the rating of the drive. It is a way to impose temporary output restrictions on the drive until the damaged inverter/converter drive assembly is repaired and reinstalled. Some customers can elect to oversize their drives, to have redundant inverter/converter assemblies.

The Re-Rate function allows the rating of the drive to be changed. This procedure is used when making long-term changes.

### N-1 and Re-Rating with Integrated Motion on EtherNet/IP

These features cannot be used while the drive is in Integrated Motion on EtherNet/IP mode. If these features are needed, disconnect the drive from the EtherNet/IP network, perform the N-1 or Re-Rate procedure, then reconnect the drive to the network.

### Use the N-1 Feature

This procedure describes how to use the N-1 feature to run the drive at reduced limits because an inverter/converter assembly has failed.

---

**IMPORTANT** You cannot flash update a drive that is using the N-1 feature.

---

For information on assembly removal and general safety precautions that are related to AC input and Common DC input PowerFlex 755 drives, refer to the PowerFlex 750-Series AC Drives Installation Instructions, publication [750-IN001](#).

1. Remove all incoming power to the drive.
2. Disconnect and remove the failed drive assembly from the cabinet.

The control pod can need to be moved from the disabled drive assembly to one of the remaining drive assemblies. See the PowerFlex 750-Series AC Drives Hardware Service Manual, publication [750-TG001](#).

3. Energize the drive.

With the drive assembly removed, an F360 “N-1 See Manual” fault is indicated.

4. Verify the new rating shown in Port 10, P21 [Effctv I Rating].

Set Port 10, P20 [Recfg Acknowledg] to 1 “Acknowledge” to accept the reconfiguration.

5. To clear the fault, press the Stop key on the HIM.

P20 [Recfg Acknowledg] automatically returns to 0 “Ready.”

Alarm 322 “N-1 Operation” is indicated, and persists, while the drive is in this reconfigured state.

6. Run the reconfigured drive with reduced current and power limits.

## Use the Re-Rate Feature

This procedure describes how to use the Re-Rate feature to run the drive at a reduced rating because a drive assembly has been removed.

1. Save the drive current parameter settings by using the Human Interface Module (HIM), DriveExecutive, or DriveExplorer.
2. Remove all incoming power to the drive.



**ATTENTION:** To avoid an electric shock hazard, verify that the voltage on the bus capacitors has discharged completely before servicing. Measure the DC bus voltage at the DC+ and DC- TESTPOINT sockets on the front of the power module.

3. Disconnect all fiber-optic cables from the fiber interface board, including the connections to the drive assemblies not removed.
4. Remove the selected drive assembly from the cabinet.
5. Energize the drive.
 

With all fiber-optic cables disconnected, “No Inverters” and “No Converters” port verification errors are indicated.
6. On the HIM, press FIX to acknowledge the error then Enter to confirm.
7. Remove all incoming power to the drive. Verify that the bus capacitors have discharged before continuing.
8. Reconnect the fiber-optic cables to the fiber interface board.
9. Energize the drive.
 

With the drive assembly removed, a “One Inverter” port verification error is indicated.
10. On the HIM, press FIX to acknowledge the error then Enter to confirm.
 

An F361 “Rerate See Manual” fault is indicated.

11. Verify the new rating shown in Port 10, P21 [Effctv I Rating].

Set Port 10, P20 [Recfg Acknowledg] to 1 “Acknowledge” to accept the reconfiguration.

---

**IMPORTANT** Drive parameters are set to factory defaults when the new rating is acknowledged. If a condition exists that does not allow the drive parameters to be set to factory defaults, setting P20 to 1 “Acknowledge” is not accepted. Such conditions include the drive is running, DeviceLogix is running, or the drive is communicating with a PLC.

---

12. To clear the fault, press the Stop key on the HIM.  
P20 [Recfg Acknowledg] automatically returns to 0 “Ready.”
13. Use the HIM download function, DriveExecutive download function, or DriveExplorer download function to download the parameter settings saved in Step 1.

---

**IMPORTANT** Do not use the Compare Screen Copy function in DriveExecutive or the Error Check Download function in DriveExplorer to perform this step.

---

14. Run the reconfigured drive at the reduced rating and power limits.

## Use the Re-Rate Feature to Add or Replace a Drive Assembly

This procedure describes how to use the Re-Rate feature to increase the drive rating because a drive assembly has been added. For example, a drive assembly has been repaired and is being reinstalled. Because the drive was Re-Rated when the drive assembly was removed, it must be re-rated again to run at full rating and power limits.

1. Save the drive current parameter settings by using the Human Interface Module (HIM), DriveExecutive, or DriveExplorer.
2. Remove all incoming power to the drive.




---

**ATTENTION:** To avoid an electric shock hazard, verify that the voltage on the bus capacitors has discharged completely before servicing. Measure the DC bus voltage at the DC+ and DC- TESTPOINT sockets on the front of the power module.

---

3. Add the drive assembly to the drive and connect it to the fiber interface board in consecutive order.

4. Energize the drive.

With the addition of a drive assembly, port verification errors indicate the number of installed drive assemblies. For example, a frame 9 would indicate “Two Inverters” and “Two Converters.”

5. On the HIM press FIX to acknowledge the error then Enter to confirm.

An F361 “Rerate See Manual” fault is indicated.

6. Verify the new rating shown in Port 10, P21 [Effctv I Rating].

Set Port 10, P20 [Recfg Acknowledg] to 1 “Acknowledge” to accept the reconfiguration.

---

**IMPORTANT** Drive parameters are set to factory defaults when reconfiguration is acknowledged. If a condition exists that does not allow the drive parameters to be set to factory defaults, setting P20 to 1 “Acknowledge” is not accepted. Such conditions include the drive is running, DeviceLogix is running, or the drive is communicating with a PLC.

---

7. To clear the fault, press the Stop key on the HIM.

P20 [Recfg Acknowledg] automatically returns to 0 “Ready.”

8. Use the HIM download function, DriveExecutive download function, or DriveExplorer download function to download the parameter settings saved in Step1.

---

**IMPORTANT** Do not use the Compare Screen Copy function in DriveExecutive or the Error Check Download function in DriveExplorer to perform this step.

---

9. Run the drive at the full rating and full power limits.

## Embedded EtherNet/IP (Port 13) Events

The adapter has an event queue to record significant events that occur in the operation of the adapter. When such an event occurs, an entry consisting of the event numeric code and a timestamp is put into the event queue. You can view the event queue by using the PowerFlex 20-HIM-A6/-C6S HIM, DriveExplorer software (version 6.01 or later), DriveExecutive software (version 5.01 or later), or other clients by using the DPI Fault object. For details on how to view and clear events by using the HIM, see the PowerFlex 20-HIM-A6/-C6S HIM (Human Interface Module) User Manual, publication [20HIM-UM001](#).

Many events in the event queue occur under normal operation. If you encounter unexpected communications problems, the events can help you or Rockwell Automation personnel troubleshoot the problem. The following events can appear in the event queue.

**Table 15 - Adapter Events**

Code	Event	Description
13001	No Event	Text that is displayed in an empty event queue entry.
13002	Device Power Up	Power was applied to the adapter.
13003	Device Reset	The adapter was reset.
13004	EEPROM CRC Error	The EEPROM checksum/CRC is incorrect, which limits adapter functionality. Default parameter values must be loaded to clear this condition.
13005	App Updated	The adapter application firmware was flash updated.
13006	Boot Updated	The adapter boot firmware was flash updated.
13007... 13024	Reserved	—

**Table 16 - DPI Events**

Code	Event	Description
13025	DPI Manual Reset	The adapter was reset.
13026... 13028	Reserved	—

**Table 17 - Network Events**

Code	Event	Description
13029	Net Link Up	A network link was available for the adapter.
13030	Net Link Down	The network link was removed from the adapter.
13031	Net Dup Address	The adapter uses the same IP address as another device on the network.
13032	Net Comm Fault	The adapter detected a communications fault on the network.
13033	Net Sent Reset	The adapter received a reset from the network.
13034	Net IO Close	An I/O connection from the network to the adapter was closed.
13035	Net Idle Fault	The adapter received "idle" packets from the network.
13036	Net IO Open	An I/O connection from the network to the adapter has been opened.
13037	Net IO Timeout	An I/O connection from the network to the adapter has timed out.
13038	Net IO Size Err	The adapter received an incorrectly sized I/O packet.
13039	PCCC IO Close	The device sending PCCC Control messages to the adapter has set the PCCC Control Timeout to zero.
13040	PCCC IO Open	The adapter has begun receiving PCCC Control messages (the PCCC Control Timeout was previously set to a non-zero value).

Code	Event	Description
13041	PCCC IO Timeout	The adapter has not received a PCCC Control message for longer than the PCCC Control Timeout.
13042	Msg Ctrl Open	The timeout attribute in either the CIP Register or Assembly object was written with a non-zero value, allowing control messages to be sent to the adapter.
13043	Msg Ctrl Close	The timeout attribute in either the CIP Register or Assembly object was written with a zero value, disallowing control messages to be sent to the adapter.
13044	Msg Ctrl Timeout	The timeout attribute in either the CIP Register or Assembly object elapsed between accesses of those objects.
13045	Peer IO Open	The adapter received the first Peer I/O message.
13046	Peer IO Timeout	The adapter has not received a Peer I/O message for longer than the Peer I/O Timeout.
13047... 13054	Reserved	–
13055	BOOTP Response	The adapter received a response to its BOOTP request.
13056	E-mail Failed	The adapter encountered an error attempting to send a requested e-mail message.
13057	Option Card Flt	The adapter experienced a generic fault condition (drive only).
13058	Module Defaulted	The adapter has been set to defaults.
13059	Net Memory Mgmt	The adapter encountered an error with buffer counters or lists.

## I/O Faults and Alarms

[Table 18](#) contains a list of I/O-specific faults and alarms, the type of fault or alarm, the action that is taken when the drive faults, the parameter that is used to configure the fault or alarm (if applicable), and a description and action (where applicable). See [Faults, Alarms, and Configurable Conditions](#) for information on the Auto Reset (Auto Reset Run/Restart) and Auto Clear (Auto Reset Clear) columns in this table.

**Table 18 - I/O Fault and Alarm Types, Descriptions, and Actions**

Event No. <sup>(1)</sup>	Fault/Alarm Text	Type	Fault Action	Configuration Parameter	Auto Reset	Auto Clear	Description/Action(s)
xx000	No Entry						
xx001	Analog In Loss	Configurable		P53/P63 [Anlg InX LssActn]		Y	Analog input has a lost signal.
xx002	Motor PTC Trip	Configurable		P40 [PTC Cfg]		Y	Motor PTC (Positive Temperature Coefficient) over temperature.
xx005	Relay0 Life	Configurable		P106 [R00 LifeEvtActn]			Predictive maintenance.
xx006	Relay1 Life	Configurable		P116 [R01 LifeEvtActn]			Predictive maintenance.
xx010	Anlg Cal Chksum	Non-Reset Fault	Coast				The checksum read from the analog calibration data does not match the checksum calculated. Replace option module.
xx058	Module Defaulted	Fault	Coast				Module was commanded to write default values.

(1) xx indicates the port number. See [Fault and Alarm Display Codes on page 319](#) for an explanation.

## Safe Torque Off Fault

[Table 19](#) lists the safe torque off-specific fault, the action taken when the drive faults, and its description.

**Table 19 - Safe Torque Fault and Alarm Types, Descriptions, and Actions**

Event No. <sup>(1)</sup>	Fault/Alarm Text	Type	Fault Action	Configuration Parameter	Auto Reset	Description/Action(s)
xx000	No Entry					
xx058	Module Defaulted	Fault	Coast			Module was commanded to write default values.

(1) xx indicates the port number. See [Fault and Alarm Display Codes on page 319](#) for an explanation.

## ATEX Faults

[Table 20](#) lists the ATEX-specific fault, the action taken when the drive faults, and its description.

**Table 20 - ATEX Fault Types, Descriptions, and Actions**

Event No. <sup>(1)</sup>	Fault/Alarm Text	Type	Fault Action	Configuration Parameter	Auto Reset	Description/Action(s)
xx011	PTC Over Temp	Resettable Fault	Coast			An over-temperature condition has been detected in the motor, or the sensor path has been broken.
xx012	PTC ShortCircuit	Resettable Fault	Coast			A short circuit condition has been detected in the sensor path. If unable to clear fault, be sure the thermal sensor that is connected is a PTC type and not a thermostatic type.
xx013	ATX VoltageLoss	Resettable Fault	Coast			Possible hardware damage. The motor to the thermal sensor is shorted. Excessive EMC noise due to improper grounding/shielding.
xx014	ThermostatOvrTmp	Resettable Fault	Coast			An over-temperature condition has been detected in the motor, or the sensor path has been broken.

(1) xx indicates the port number where the ATEX option is installed.

## Single Incremental Encoder Faults and Alarms

[Table 21](#) contains a list of encoder-specific faults and alarms, the type of fault or alarm, the action that is taken when the drive faults, the parameter that is used to configure the fault or alarm (if applicable), and a description and action (where applicable).

**Table 21 - Single Incremental Encoder Fault and Alarm Types, Descriptions, and Actions**

Event No. <sup>(1)</sup>	Fault/Alarm Text	Type	Fault Action	Configuration Parameter	Auto Reset	Description/Action(s)
xx000	Open Wire	Configurable		P3 [Fdbk Loss Cfg]		The encoder module has detected an input signal (A, B, or Z) in the same state as its complement (A Not, B Not, or Z Not). For open wire detection to work, the encoder signals must be differential (not single ended). The Z channel is only checked when enabled. See P1 [Encoder Cfg].
xx001	Phase Loss	Configurable		P3 [Fdbk Loss Cfg]		More than 30-phase loss (open wire) events have occurred over an 8 millisecond time period. The same restrictions as for Open Wire detection apply.
xx002	Quadrature Loss	Configurable		P3 [Fdbk Loss Cfg]		Quadrature loss events occur when simultaneous edge transitions occur on both the A and B encoder channels. This fault occurs when more than 10 quad loss events over a 10 millisecond time period are detected. Only valid when both A and B channels are used (not Bit 1 "A Chan Only") in P1 [Encoder Cfg].
xx058	Module Defaulted	Fault	Coast			Module was commanded to write default values.

(1) xx indicates the port number. See [Fault and Alarm Display Codes on page 319](#) for an explanation.



## Dual Incremental Encoder Faults and Alarms

Table 22 contains a list of encoder-specific faults and alarms, the type of fault or alarm, the action that is taken when the drive faults, the parameter that is used to configure the fault or alarm (if applicable), and a description and action (where applicable).

**Table 22 - Dual Incremental Encoder Fault and Alarm Types, Descriptions, and Actions**

Event No. <sup>(1)</sup>	Fault/Alarm Text	Type	Fault Action	Configuration Parameter	Auto Reset	Description/Action(s)
xx000	Enc0 Open Wire	Configurable		P3 [Enc 0 FB Lss Cfg]		The dual encoder module has detected an encoder 0 input signal (A, B, or Z) in the same state as its complement (A Not, B Not, or Z Not). For open wire detection to work, the encoder signals must be differential (not single ended). The Z channel is only checked when enabled. See P1 [Enc 0 Cfg].
xx001	Enc0 Phase Loss	Configurable		P3 [Enc 0 FB Lss Cfg]		More than 30 encoder 0 phase loss (open wire) events have occurred over an 8 millisecond time period. The same restrictions as for Enc0 Open Wire detection apply.
xx002	Enc0 Quad Loss	Configurable		P3 [Enc 0 FB Lss Cfg]		Encoder 0 Quadrature loss events occur when simultaneous edge transitions occur on both the A and B channels of encoder 0. This fault occurs when more than 10 quad loss events over a 10 millisecond time period are detected. Only valid when both A and B channels are used (not Bit 1 "A Chan Only") in P1 [Enc 0 Cfg].
xx030	Enc1 Open Wire	Configurable		P13 [Enc 1 FB Lss Cfg]		The dual encoder module has detected an encoder 1 input signal (A, B, or Z) in the same state as its complement (A Not, B Not, or Z Not). For open wire detection to work, the encoder signals must be differential (not single ended). The Z channel is only checked when enabled. See P11 [Enc 1 Cfg].
xx031	Enc1 Phase Loss	Configurable		P13 [Enc 1 FB Lss Cfg]		More than 30 encoder 1 phase loss (open wire) events have occurred over an 8 millisecond time period. The same restrictions as for Enc1 Open Wire detection apply.
xx032	Enc1 Quad Loss	Configurable		P13 [Enc 1 FB Lss Cfg]		Encoder 1 Quadrature loss events occur when simultaneous edge transitions occur on both the A and B channels of encoder 1. This fault occurs when more than 10 quad loss events over a 10 millisecond time period are detected. Only valid when both A and B channels are used (not Bit 1 "A Chan Only") in P11 [Enc 1 Cfg].
xx058	Module Defaulted	Fault	Coast			Module was commanded to write default values.

(1) xx indicates the port number. See [Fault and Alarm Display Codes on page 319](#) for an explanation.

## Universal Feedback Faults and Alarms

Table 23 contains a list of universal feedback-specific faults and alarms, the type of fault or alarm, the action that is taken when the drive faults, the parameter that is used to configure the fault or alarm (if applicable), and a description and action (where applicable).

**Table 23 - Universal Feedback Fault and Alarm Types, Descriptions, and Actions**

Event No. <sup>(1)</sup>	Fault/Alarm Text	Type	Fault Action	Configuration Param	Auto Reset	Description
xx000	LightSrc Err	Configurable		P9 [FBO Loss Cfg]		Error reported by Heidenhain Encoder on Channel 0 with EnDat Interface - Light source failure
xx001	Ch0 SigAmp Err	Configurable		P9 [FBO Loss Cfg]		Error reported by Heidenhain Encoder on Channel 0 with EnDat Interface - Signal amplitude error
xx002	Ch0 PsnVal Err	Configurable		P9 [FBO Loss Cfg]		Error reported by Heidenhain Encoder on Channel 0 with EnDat Interface - Position value error
xx003	Ch0 OverVolt Err	Configurable		P9 [FBO Loss Cfg]		Error reported by Heidenhain Encoder on Channel 0 with EnDat Interface - Overvoltage error
xx004	Ch0 UndVolt Err	Configurable		P9 [FBO Loss Cfg]		Error reported by Heidenhain Encoder on Channel 0 with EnDat Interface - Undervoltage error
xx005	Ch0 OverCur Err	Configurable		P9 [FBO Loss Cfg]		Error reported by Heidenhain Encoder on Channel 0 with EnDat Interface - Overcurrent error
xx006	Ch0 Battery Err	Configurable		P9 [FBO Loss Cfg]		Error reported by Heidenhain Encoder on Channel 0 with EnDat Interface - Battery empty
xx009	Ch0 AnalSig Err	Configurable		P9 [FBO Loss Cfg]		Error reported by Stegmann Encoder on Channel 0 with Hiperface Interface - Analog signals outside specification
xx010	Ch0 IntOfst Err	Configurable		P9 [FBO Loss Cfg]		Error reported by Stegmann Encoder on Channel 0 with Hiperface Interface - Faulty internal angular offset
xx011	Ch0 DataTabl Err	Configurable		P9 [FBO Loss Cfg]		Error reported by Stegmann Encoder on Channel 0 with Hiperface Interface - Data field partitioning table damaged
xx012	Ch0 AnalLim Err	Configurable		P9 [FBO Loss Cfg]		Error reported by Stegmann Encoder on Channel 0 with Hiperface Interface - Analog limit values not available
xx013	Ch0 Int I2C Err	Configurable		P9 [FBO Loss Cfg]		Error reported by Stegmann Encoder on Channel 0 with Hiperface Interface - Internal I2C bus not operational
xx014	Ch0 IntChksum Err	Configurable		P9 [FBO Loss Cfg]		Error reported by Stegmann Encoder on Channel 0 with Hiperface Interface - Internal checksum error
xx015	Ch0 PrgmResetErr	Configurable		P9 [FBO Loss Cfg]		Error reported by Stegmann Encoder on Channel 0 with Hiperface Interface - Encoder reset occurred as a result of program monitoring
xx016	Ch0 CntOvrflwErr	Configurable		P9 [FBO Loss Cfg]		Error reported by Stegmann Encoder on Channel 0 with Hiperface Interface - Counter overflow
xx017	Ch0 Parity Err	Configurable		P9 [FBO Loss Cfg]		Error reported by Stegmann Encoder on Channel 0 with Hiperface Interface - Parity error
xx018	Ch0 Chksum Err	Configurable		P9 [FBO Loss Cfg]		Error reported by Stegmann Encoder on Channel 0 with Hiperface Interface - Checksum of the data that are transmitted is incorrect
xx019	Ch0 InvCmd Err	Configurable		P9 [FBO Loss Cfg]		Error reported by Stegmann Encoder on Channel 0 with Hiperface Interface - Unknown command code
xx020	Ch0 SendSize Err	Configurable		P9 [FBO Loss Cfg]		Error reported by Stegmann Encoder on Channel 0 with Hiperface Interface - Number of data that are transmitted is incorrect
xx021	Ch0 CmdArgmt Err	Configurable		P9 [FBO Loss Cfg]		Error reported by Stegmann Encoder on Channel 0 with Hiperface Interface - Command argument that is transmitted is not allowed
xx022	Ch0 InvWrtAdrErr	Configurable		P9 [FBO Loss Cfg]		Error reported by Stegmann Encoder on Channel 0 with Hiperface Interface - The selected data field must not be written to (invalid write address)

Event No. <sup>(1)</sup>	Fault/Alarm Text	Type	Fault Action	Configuration Param	Auto Reset	Description
xx023	Ch0 AccCode Err	Configurable		P9 [FBO Loss Cfg]		Error reported by Stegmann Encoder on Channel 0 with Hiperface Interface - Incorrect access code
xx024	Ch0 FieldSizeErr	Configurable		P9 [FBO Loss Cfg]		Error reported by Stegmann Encoder on Channel 0 with Hiperface Interface - Size of data field that is stated cannot be changed
xx025	Ch0 Address Err	Configurable		P9 [FBO Loss Cfg]		Error reported by Stegmann Encoder on Channel 0 with Hiperface Interface - Word address that is stated is outside data field
xx026	Ch0 FieldAcc Err	Configurable		P9 [FBO Loss Cfg]		Error reported by Stegmann Encoder on Channel 0 with Hiperface Interface - Access to non-existent data field
xx028	Ch0 SiTurnPsnErr	Configurable		P9 [FBO Loss Cfg]		Error reported by Stegmann Encoder on Channel 0 with Hiperface Interface - Single turn position unreliable
xx029	Ch0 MulTrnPsnErr	Configurable		P9 [FBO Loss Cfg]		Error reported by Stegmann Encoder on Channel 0 with Hiperface Interface - Multiple turn position unreliable
xx036	Ch0 AnalVal Err	Configurable		P9 [FBO Loss Cfg]		Error reported by Stegmann Encoder on Channel 0 with Hiperface Interface - Analog value error (process data)
xx037	Ch0 SendCurr Err	Configurable		P9 [FBO Loss Cfg]		Error reported by Stegmann Encoder on Channel 0 with Hiperface Interface - Transmitter current critical (dirt, broken transmitter)
xx038	Ch0 EncTemp Err	Configurable		P9 [FBO Loss Cfg]		Error reported by Stegmann Encoder on Channel 0 with Hiperface Interface - Encoder temperature critical
xx039	Ch0 Speed Err	Configurable		P9 [FBO Loss Cfg]		Error reported by Stegmann Encoder on Channel 0 with Hiperface Interface - Speed too high, no position formation possible
xx040	Ch0 General Err	Configurable		P9 [FBO Loss Cfg]		Error reported by an Encoder on Channel 0 with BiSS Interface - An error bit of the BiSS Single Cycle Data is set
xx046	Ch0 LED Curr Err	Configurable		P9 [FBO Loss Cfg]		Error reported by an Encoder on Channel 0 with BiSS Interface - LED current out of control range
xx047	Ch0 ExMulTurnErr	Configurable		P9 [FBO Loss Cfg]		Error reported by an Encoder on Channel 0 with BiSS Interface - External multi-turn error
xx048	Ch0 PsnCode Err	Configurable		P9 [FBO Loss Cfg]		Error reported by an Encoder on Channel 0 with BiSS Interface - Position code error (single-step error)
xx049	Ch0 Config Err	Configurable		P9 [FBO Loss Cfg]		Error reported by an Encoder on Channel 0 with BiSS Interface - failure configuring interface
xx050	Ch0 PsnVal Err	Configurable		P9 [FBO Loss Cfg]		Error reported by an Encoder on Channel 0 with BiSS Interface - Position data not valid
xx051	Ch0 SerialComErr	Configurable		P9 [FBO Loss Cfg]		Error reported by an Encoder on Channel 0 with BiSS Interface - Serial interface failure
xx052	Ch0 Ext Failure	Configurable		P9 [FBO Loss Cfg]		Error reported by an Encoder on Channel 0 with BiSS Interface - External failure over NERR
xx053	Ch0 Temp Exc Err	Configurable		P9 [FBO Loss Cfg]		Error reported by an Encoder on Channel 0 with BiSS Interface - Temperature out of defined range
xx058	Module Defaulted	Fault	Coast			Parameter values for this encoder have been reset to their default settings.
xx064	Ch0 OutOfRailErr	Configurable		P9 [FBO Loss Cfg]		Error reported by a linear Stahl encoder on Channel 0 - Rail is no longer present between the read head
xx068	Ch0 Read Head 1	Configurable		P9 [FBO Loss Cfg]		Error reported by a linear Stahl encoder on Channel 0 - Indicates that the read head must be cleaned or installed correctly
xx069	Ch0 Read Head 2	Configurable		P9 [FBO Loss Cfg]		Error reported by a linear Stahl encoder on Channel 0 - Indicates that the read head must be cleaned or installed correctly
xx070	Ch0 RAM Error	Configurable		P9 [FBO Loss Cfg]		Error reported by a linear Stahl encoder on Channel 0 - Indicates a RAM error. Reading head must be repaired
xx071	Ch0 EPROM Error	Configurable		P9 [FBO Loss Cfg]		Error reported by a linear Stahl encoder on Channel 0 - Indicates an EPROM error. Reading head must be repaired

Event No. <sup>(1)</sup>	Fault/Alarm Text	Type	Fault Action	Configuration Param	Auto Reset	Description
xx072	Ch0 ROM Error	Configurable		P9 [FBO Loss Cfg]		Error reported by a linear Stahl encoder on Channel 0 - Indicates a ROM error. Reading head must be repaired
xx074	Ch0 No Position	Configurable		P9 [FBO Loss Cfg]		Error reported by a linear Stahl encoder on Channel 0 - Indicates that no position value was available - only possible following powerup or reset
xx081	Ch0 Msg Cheksum	Configurable		P9 [FBO Loss Cfg]		Indicates that the option card has detected a serial communications checksum error while attempting to communicate with the encoder on channel 0.
xx082	Ch0 Timeout	Configurable		P9 [FBO Loss Cfg]		Indicates that the option card has detected a serial communications timeout error while attempting to communicate with the encoder on channel 0.
xx083	Ch0 Comm	Configurable		P9 [FBO Loss Cfg]		Indicates that the option card has detected a serial communications error (other than checksum or timeout) while attempting to communicate with the encoder on channel 0.
xx084	Ch0 Diagnostic	Configurable		P9 [FBO Loss Cfg]		Indicates that the option card has detected a powerup diagnostic test failure for encoder channel 0.
xx085	Ch0 SplyVltgRng	Configurable		P9 [FBO Loss Cfg]		Indicates that the voltage source to the encoder 0 is out of range.
xx086	Ch0 SC Amplitude	Configurable		P9 [FBO Loss Cfg]		Indicates that the encoder 0 signal amplitude is out of tolerance.
xx087	Ch0 Open Wire	Configurable		P9 [FBO Loss Cfg]		Indicates that an open wire condition has been detected for encoder 0. Both Sine and Cosine signals fell below 0.3 volts.
xx088	Ch0 Quad Loss	Configurable		P9 [FBO Loss Cfg]		Indicates that a signal quadrature error has been detected for encoder 0. Add ferite cores.
xx089	Ch0 Phase Loss	Configurable		P9 [FBO Loss Cfg]		Indicates that an A or B signal of an A quad B incremental encoder on Channel 0 is disconnected.
xx090	Ch0 Unsupp Enc	Configurable		P9 [FBO Loss Cfg]		Indicates that the connected encoder on Channel 0 is not supported
xx100	Ch0 FreqExc Alm	Alarm 1		P9 [FBO Loss Cfg]		Alarm reported by Heidenhain Encoder on Channel 0 with EnDat Interface - Frequency exceeded warning
xx101	Ch0 TempExc Alm	Alarm 1		P9 [FBO Loss Cfg]		Alarm reported by Heidenhain Encoder on Channel 0 with EnDat Interface - Temperature exceeded warning
xx102	Ch0 LightLim Alm	Alarm 1		P9 [FBO Loss Cfg]		Alarm reported by Heidenhain Encoder on Channel 0 with EnDat Interface - Limit of light control reserve reached
xx103	Ch0 Battery Alm	Alarm 1		P9 [FBO Loss Cfg]		Alarm reported by Heidenhain Encoder on Channel 0 with EnDat Interface - Battery warning
xx104	Ch0 RefPoint Alm	Alarm 1		P9 [FBO Loss Cfg]		Alarm reported by Heidenhain Encoder on Channel 0 with EnDat Interface - Reference point not reached
xx108	Ch0 General Alm	Alarm 1		P9 [FBO Loss Cfg]		Alarm reported by an Encoder on Channel 0 with BiSS Interface - A warning bit of the BiSS Single Cycle Data is set
xx115	Ch0 Optics Alarm	Alarm 1		P9 [FBO Loss Cfg]		Alarm reported by a linear Stahl encoder on Channel 0 - Displays an alarm when the Stahl optical system requires cleaning
xx116	Ch0 OutOfRailAlm	Alarm 1		P9 [FBO Loss Cfg]		Alarm reported by a linear Stahl encoder on Channel 0 - Indicates that the read encoder count is at the maximum value (524287)
xx200	Ch1 LightSrc Err	Configurable		P39 [FB1 Loss Cfg]		Error reported by Heidenhain Encoder on Channel 1 with EnDat Interface - Light source failure
xx201	Ch1 SigAmp Err	Configurable		P39 [FB1 Loss Cfg]		Error reported by Heidenhain Encoder on Channel 1 with EnDat Interface - Signal amplitude error
xx202	Ch1 PsnVal Err	Configurable		P39 [FB1 Loss Cfg]		Error reported by Heidenhain Encoder on Channel 1 with EnDat Interface - Position value error
xx203	Ch1 OverVolt Err	Configurable		P39 [FB1 Loss Cfg]		Error reported by Heidenhain Encoder on Channel 1 with EnDat Interface - Overvoltage error

Event No. <sup>(1)</sup>	Fault/Alarm Text	Type	Fault Action	Configuration Param	Auto Reset	Description
xx204	Ch1 UndVolt Err	Configurable		P39 [FB1 Loss Cfg]		Error reported by Heidenhain Encoder on Channel 1 with EnDat Interface - Undervoltage error
xx205	Ch1 OverCur Err	Configurable		P39 [FB1 Loss Cfg]		Error reported by Heidenhain Encoder on Channel 1 with EnDat Interface - Overcurrent error
xx206	Ch1 Battery Err	Configurable		P39 [FB1 Loss Cfg]		Error reported by Heidenhain Encoder on Channel 1 with EnDat Interface - Battery empty
xx209	Ch1 AnalSig Err	Configurable		P39 [FB1 Loss Cfg]		Error reported by Stegmann Encoder on Channel 1 with Hiperface Interface - Analog signals outside specification
xx210	Ch1 IntOfst Err	Configurable		P39 [FB1 Loss Cfg]		Error reported by Stegmann Encoder on Channel 1 with Hiperface Interface - Faulty internal angular offset
xx211	Ch1 DataTabl Err	Configurable		P39 [FB1 Loss Cfg]		Error reported by Stegmann Encoder on Channel 1 with Hiperface Interface - Data field partitioning table damaged
xx212	Ch1 AnalLim Err	Configurable		P39 [FB1 Loss Cfg]		Error reported by Stegmann Encoder on Channel 1 with Hiperface Interface - Analog limit values not available
xx213	Ch1 Int I2C Err	Configurable		P39 [FB1 Loss Cfg]		Error reported by Stegmann Encoder on Channel 1 with Hiperface Interface - Internal I2C bus not operational
xx214	Ch1 IntChksm Err	Configurable		P39 [FB1 Loss Cfg]		Error reported by Stegmann Encoder on Channel 1 with Hiperface Interface - Internal checksum error
xx215	Ch1 PrgmResetErr	Configurable		P39 [FB1 Loss Cfg]		Error reported by Stegmann Encoder on Channel 1 with Hiperface Interface - Encoder reset occurred as a result of program monitoring
xx216	Ch1 CntOvrflwErr	Configurable		P39 [FB1 Loss Cfg]		Error reported by Stegmann Encoder on Channel 1 with Hiperface Interface - Counter overflow
xx217	Ch1 Parity Err	Configurable		P39 [FB1 Loss Cfg]		Error reported by Stegmann Encoder on Channel 1 with Hiperface Interface - Parity error
xx218	Ch1 Chksum Err	Configurable		P39 [FB1 Loss Cfg]		Error reported by Stegmann Encoder on Channel 1 with Hiperface Interface - Checksum of the data that is transmitted is incorrect
xx219	Ch1 InvCmd Err	Configurable		P39 [FB1 Loss Cfg]		Error reported by Stegmann Encoder on Channel 1 with Hiperface Interface - Unknown command code
xx220	Ch1 SendSize Err	Configurable		P39 [FB1 Loss Cfg]		Error reported by Stegmann Encoder on Channel 1 with Hiperface Interface - Number of data that is transmitted is incorrect
xx221	Ch1 CmdArgmt Err	Configurable		P39 [FB1 Loss Cfg]		Error reported by Stegmann Encoder on Channel 1 with Hiperface Interface - Command argument that is transmitted is not allowed
xx222	Ch1 InvWrtAdrErr	Configurable		P39 [FB1 Loss Cfg]		Error reported by Stegmann Encoder on Channel 1 with Hiperface Interface - The selected data field must not be written to (invalid write address)
xx223	Ch1 AccCode Err	Configurable		P39 [FB1 Loss Cfg]		Error reported by Stegmann Encoder on Channel 1 with Hiperface Interface - Incorrect access code
xx224	Ch1 FieldSizeErr	Configurable		P39 [FB1 Loss Cfg]		Error reported by Stegmann Encoder on Channel 1 with Hiperface Interface - Size of data field that is stated cannot be changed
xx225	Ch1 Address Err	Configurable		P39 [FB1 Loss Cfg]		Error reported by Stegmann Encoder on Channel 1 with Hiperface Interface - Word address that is stated is outside data field
xx226	Ch1 FieldAcc Err	Configurable		P39 [FB1 Loss Cfg]		Error reported by Stegmann Encoder on Channel 1 with Hiperface Interface - Access to non-existent data field
xx228	Ch1 SiTurnPsnErr	Configurable		P39 [FB1 Loss Cfg]		Error reported by Stegmann Encoder on Channel 1 with Hiperface Interface - Single turn position unreliable
xx229	Ch1 MulTrmPsnErr	Configurable		P39 [FB1 Loss Cfg]		Error reported by Stegmann Encoder on Channel 1 with Hiperface Interface - Multiple turn position unreliable
xx236	Ch1 AnalVal Err	Configurable		P39 [FB1 Loss Cfg]		Error reported by Stegmann Encoder on Channel 1 with Hiperface Interface - Analog value error (process data)

Event No. <sup>(1)</sup>	Fault/Alarm Text	Type	Fault Action	Configuration Param	Auto Reset	Description
xx237	Ch1 SendCurr Err	Configurable		P39 [FB1 Loss Cfg]		Error reported by Stegmann Encoder on Channel 1 with Hiperface Interface - Transmitter current critical (dirt, broken transmitter)
xx238	Ch1 EncTemp Err	Configurable		P39 [FB1 Loss Cfg]		Error reported by Stegmann Encoder on Channel 1 with Hiperface Interface - Encoder temperature critical
xx239	Ch1 Speed Err	Configurable		P39 [FB1 Loss Cfg]		Error reported by Stegmann Encoder on Channel 1 with Hiperface Interface - Speed too high, no position formation possible
xx240	Ch1 General Err	Configurable		P39 [FB1 Loss Cfg]		Error reported by an Encoder on Channel 1 with BiSS Interface - An error bit of the BiSS Single Cycle Data is set
xx246	Ch1 LED Curr Err	Configurable		P39 [FB1 Loss Cfg]		Error reported by an Encoder on Channel 1 with BiSS Interface - LED current out of control range
xx247	Ch1 ExMulTurnErr	Configurable		P39 [FB1 Loss Cfg]		Error reported by an Encoder on Channel 1 with BiSS Interface - External multi-turn error
xx248	Ch1 PsnCode Err	Configurable		P39 [FB1 Loss Cfg]		Error reported by an Encoder on Channel 1 with BiSS Interface - Position code error (single step error)
xx249	Ch1 Config Err	Configurable		P39 [FB1 Loss Cfg]		Error reported by an Encoder on Channel 1 with BiSS Interface - failure configuring interface
xx250	Ch1 PsnVal Err	Configurable		P39 [FB1 Loss Cfg]		Error reported by an Encoder on Channel 1 with BiSS Interface - Position data not valid
xx251	Ch1 SerialComErr	Configurable		P39 [FB1 Loss Cfg]		Error reported by an Encoder on Channel 1 with BiSS Interface - Serial interface failure
xx252	Ch1 Ext Failure	Configurable		P39 [FB1 Loss Cfg]		Error reported by an Encoder on Channel 1 with BiSS Interface - External failure over NERR
xx253	Ch1 Temp Exc Err	Configurable		P39 [FB1 Loss Cfg]		Error reported by an Encoder on Channel 1 with BiSS Interface - Temperature out of defined range
xx256	Ch1 OutOfRailErr	Configurable		P39 [FB1 Loss Cfg]		Error reported by a linear Stahl encoder on Channel 1 - Rail is no longer present between the read head
xx260	Ch1 Read Head 1	Configurable		P39 [FB1 Loss Cfg]		Error reported by a linear Stahl encoder on Channel 1 - Indicates that the read head must be cleaned or installed correctly
xx261	Ch1 Read Head 2	Configurable		P39 [FB1 Loss Cfg]		Error reported by a linear Stahl encoder on Channel 1 - Indicates that the read head must be cleaned or installed correctly
xx262	Ch1 RAM Error	Configurable		P39 [FB1 Loss Cfg]		Error reported by a linear Stahl encoder on Channel 1 - Indicates a RAM error. Reading head must be repaired
xx263	Ch1 EPROM Error	Configurable		P39 [FB1 Loss Cfg]		Error reported by a linear Stahl encoder on Channel 1 - Indicates an EPROM error. Reading head must be repaired
xx264	Ch1 ROM Error	Configurable		P39 [FB1 Loss Cfg]		Error reported by a linear Stahl encoder on Channel 1 - Indicates a ROM error. Reading head must be repaired
xx266	Ch1 No Position	Configurable		P39 [FB1 Loss Cfg]		Error reported by a linear Stahl encoder on Channel 1 - Indicates that no position value was available - only possible following powerup or reset
xx281	Ch1 Msg Cheksum	Configurable		P39 [FB1 Loss Cfg]		Indicates that the option card has detected a serial communications checksum error while attempting to communicate with the encoder on channel 1.
xx282	Ch1 Timeout	Configurable		P39 [FB1 Loss Cfg]		Indicates that the option card has detected a serial communications timeout error while attempting to communicate with the encoder on channel 1.
xx283	Ch1 Comm	Configurable		P39 [FB1 Loss Cfg]		Indicates that the option card has detected a serial communications error (other than checksum or timeout) while attempting to communicate with the encoder on channel 1.
xx284	Ch1 Diagnostic	Configurable		P39 [FB1 Loss Cfg]		Indicates that the option card has detected a powerup diagnostic test failure for encoder channel 1.
xx285	Ch1 SplyVltgRng	Configurable		P39 [FB1 Loss Cfg]		Indicates that the voltage source to the encoder 1 is out of range.

Event No. <sup>(1)</sup>	Fault/Alarm Text	Type	Fault Action	Configuration Param	Auto Reset	Description
xx286	Ch1 SC Amplitude	Configurable		P39 [FB1 Loss Cfg]		Indicates that the encoder 1 signal amplitude is out of tolerance.
xx287	Ch1 Open Wire	Configurable		P39 [FB1 Loss Cfg]		Indicates that an open wire condition has been detected for encoder 1.
xx288	Ch1 Quad Loss	Configurable		P39 [FB1 Loss Cfg]		Indicates that a signal quadrature error has been detected for encoder 1
xx289	Ch1 Phase Loss	Configurable		P39 [FB1 Loss Cfg]		Indicates that an A or B signal of an A quad B incremental encoder on Channel 1 is disconnected.
xx290	Ch1 Unsupp Enc	Configurable		P39 [FB1 Loss Cfg]		Indicates that the connected encoder on Channel 1 is not supported
xx300	Ch1 FreqExc Alm	Alarm 1		P39 [FB1 Loss Cfg]		Alarm reported by Heidenhain Encoder on Channel 1 with EnDat Interface - Frequency exceeded warning
xx301	Ch1 TempExc Alm	Alarm 1		P39 [FB1 Loss Cfg]		Alarm reported by Heidenhain Encoder on Channel 1 with EnDat Interface - Temperature exceeded warning
xx302	Ch1 LightLim Alm	Alarm 1		P39 [FB1 Loss Cfg]		Alarm reported by Heidenhain Encoder on Channel 1 with EnDat Interface - Limit of light control reserve reached
xx303	Ch1 Battery Alm	Alarm 1		P39 [FB1 Loss Cfg]		Alarm reported by Heidenhain Encoder on Channel 1 with EnDat Interface - Battery warning
xx304	Ch1 RefPoint Alm	Alarm 1		P39 [FB1 Loss Cfg]		Alarm reported by Heidenhain Encoder on Channel 1 with EnDat Interface - Reference point not reached
xx308	Ch1 General Alm	Alarm 1		P39 [FB1 Loss Cfg]		Alarm reported by an Encoder on Channel 1 with BiSS Interface - A warning bit of the BiSS Single Cycle Data is set
xx315	Ch1 Optics Alarm	Alarm 1		P39 [FB1 Loss Cfg]		Alarm reported by a linear Stahl encoder on Channel 1 - Displays an alarm when the Stahl optical system requires cleaning
xx316	Ch1 OutOfRailAlm	Alarm 1		P39 [FB1 Loss Cfg]		Alarm reported by a linear Stahl encoder on Channel 1 - Indicates that the read encoder count is at the maximum value (524287)
xx412	Hardware Err	Configurable		Either P9 [FB0 Loss Cfg] or P39 [FB1 Loss Cfg]		Indicates that there is a Hardware Error on the Feedback Option module.
xx413	Firmware Err	Configurable		Either P9 [FB0 Loss Cfg] or P39 [FB1 Loss Cfg]		Indicates that there is a Firmware Error on the Feedback Option module. A Firmware Error occurs if the Hardware and the downloaded Firmware are not compatible. This error could also indicate that communication between the Feedback Option module and the Main Control Board was interrupted during power-up. Cycle power to clear this fault.
xx416	EncOut Cflct	Alarm 1		Either P9 [FB0 Loss Cfg] or P39 [FB1 Loss Cfg]		Indicates that there is one of the following problems with the Encoder Output: <ul style="list-style-type: none"> <li>The selection in the P80 [Enc Out Sel] is not possible since the required pins on the terminal blocks are already used for Feedback 0 or 1 according to P6 [FB0 Device Sel] and P36 [FB1 Device Sel].</li> <li>P80 [Enc Out Sel] is set to 2 "Sine Cosine" and there is no signal connected to the pins 1...4 of TB 1.</li> <li>P80 [Enc Out Sel] is set to 2 "Sine Cosine," the value of P15/45 [FBX IncAndSC PPR] is not a power of two, and P84 [EncOut Z PPR] is not set to 0 "1 ZPulse." The value of P15/45 [FBX IncAndSC PPR] must be a power of two.</li> <li>P80 [Enc Out Sel] is set to 3 "Channel X" or 4 "Channel Y" and there is no encoder connected to that channel.</li> <li>P80 [Enc Out Sel] is set to 3 "Channel X" or 4 "Channel Y" and there is a linear encoder connected to this channel.</li> </ul>

Event No. <sup>(1)</sup>	Fault/Alarm Text	Type	Fault Action	Configuration Param	Auto Reset	Description
xx417	Safety Cflct	Alarm 1		Either P9 [FB0 Loss Cfg] or P39 [FB1 Loss Cfg]		Indicates that the Safety DIP switches are in an invalid position.
xx420	FBOFB1 Cflct	Alarm 2				Indicates that the combination of the feedback selection that is done with P6 [FB0 Device Sel] and P36 [FB1 Device Sel] is invalid, i.e. both feedbacks have Sin-Cos-Signals (There is only place for one set of Sin-Cos-Signals on the Terminal Blocks). The drive cannot be started until this configuration conflict is resolved.
xx421	Initializing	Alarm 2				Indicates that the Universal Feedback State Machine is in the Initialize State. This Type 2 alarm is provided to be sure that the motor cannot be started during this state.

(1) xx indicates the port number. See [Fault and Alarm Display Codes on page 319](#) for an explanation.



## Port Verification

When connecting to select devices, such as PowerFlex 750-Series drives, the Port Verification dialog box displays if device conflicts are found during the connection process. These conflicts typically require resolution before the connection is established with the device.

The information and options available in this dialog box are detailed here:

Item	Description
Previous Setup	Identifies the device that was previously installed at this port.
Current Setup	Identifies the device that is currently installed at the port (if applicable).
(Device Not Found)	A message identifying the conflict at the identified port.
Changed	Indicates that the device previously installed at the port that is identified has been removed or changed to another device.
Not supported - Must remove device before connection	Indicates that the device currently installed at the port that is identified has a firmware revision that is not compatible with the drive. The drive must be flash updated to be able to use this device or the device must be removed from the port before a connection can be made.
Not functioning - Must remove device before connection	Indicates that the device currently installed at the port that is identified is not functioning. The device must be removed from the port before a connection can be made.
Invalid Duplicate - Must remove device before connection	Indicates that the device currently installed at the port that is identified is already installed at another port for the device to which you are attempting to connect and the device cannot support the number of devices installed. The duplicate device must be removed from the port before a connection can be made.
Requires Configuration	Indicates that the device installed at the port that is identified requires configuration before a connection can be made.
Accept All	Accepts all configuration changes and continues the device connection process.
Cancel	Cancels the device connection process.

## Common Symptoms and Corrective Actions

### Drive does not Start from Start or Run Inputs wired to the terminal block.

Cause(s)	Indication	Corrective Action
Drive is Faulted	Flashing red status light	Clear fault. <ul style="list-style-type: none"> <li>• Press Stop</li> <li>• Cycle power</li> <li>• "Clear Faults" on the HIM Diagnostic menu.</li> </ul>
Incorrect input wiring. See Installation Instructions, publication 750-IN001, for wiring examples. <ul style="list-style-type: none"> <li>• 2 wire control requires Run, Run Forward, Run Reverse or Jog input.</li> <li>• 3 wire control requires Start and Stop inputs.</li> <li>• Verify 24 Volt Common is connected to Digital Input Common.</li> </ul>	None	Wire inputs correctly.
Incorrect digital input programming. <ul style="list-style-type: none"> <li>• Mutually exclusive choices have been made (i.e., Jog and Jog Forward).</li> <li>• 2 wire and 3 wire programming may be conflicting.</li> <li>• Start configured without a Stop configured.</li> </ul>	None	Configure input function.
	Flashing yellow status light and "DigIn Cnfg B" or "DigIn Cnfg C" indication on LCD HIM. P936 [Drive Status 2] shows type 2 alarm(s).	Resolve input function conflicts.
Terminal block does not have control.	None	Check P324 [Logic Mask].

**Drive does not Start from HIM.**

Cause(s)	Indication	Corrective Action
Drive is configured for 2 wire level control.	None	Change P150 [Digital In Conf] to correct control function.
Another device has Manual control.	None	
Port does not have control.	None	Change P324 [Logic Mask] to enable correct port.

**Drive does not respond to changes in speed command.**

Cause(s)	Indication	Corrective Action
No value is coming from the source of the command.	LCD HIM Status Line indicates "At Speed" and output is 0 Hz.	<ol style="list-style-type: none"> <li>1. If the source is an analog input, check wiring and use a meter to check for presence of signal.</li> <li>2. Check P2 [Commanded SpdRef] for correct source. <a href="#">(See page 54)</a></li> </ol>
Incorrect reference source has been programmed.	None	<ol style="list-style-type: none"> <li>3. Check P545 [Spd Ref A Sel] for the source of the speed reference. <a href="#">(See page 119)</a></li> <li>4. Reprogram P545 [Spd Ref A Sel] for correct source. <a href="#">(See page 119)</a></li> </ol>
Incorrect Reference source is being selected via remote device or digital inputs.	None	<ol style="list-style-type: none"> <li>5. Check P935 [Drive Status 1], <a href="#">page 163</a>, bits 12 and 13 for unexpected source selections.</li> <li>6. Check P220 [Digital In Sts], <a href="#">page 78</a> to see if inputs are selecting an alternate source.</li> <li>7. Check configuration of P173...175 [DI Speed Sel n] functions</li> </ol>

**Motor and/or drive does not accelerate to commanded speed.**

Cause(s)	Indication	Corrective Action
Acceleration time is excessive.	None	Reprogram P535/536 [Accel Time X]. <a href="#">(See page 118)</a>
Excess load or short acceleration times force the drive into current limit, slowing or stopping acceleration.	None	Check P935 [Drive Status 1], bit 27 to see if the drive is in Current Limit. <a href="#">(See page 163)</a> Remove excess load or reprogram P535/536 [Accel Time n]. <a href="#">(See page 118)</a>
Speed command source or value is not as expected.	None	Check for the proper Speed Command using Steps 1...7 in "Drive does not respond to changes in speed command."
Programming is preventing the drive output from exceeding limiting values.	None	Check P520 [Max Fwd Speed], P521 [Max Rev Speed] <a href="#">(See page 117)</a> and P37 [Maximum Freq] <a href="#">(See page 57)</a> to assure that speed is not limited by programming.

**Motor operation is unstable.**

Cause(s)	Indication	Corrective Action
Motor data was incorrectly entered or Autotune was not performed.	None	<ol style="list-style-type: none"> <li>1. Correctly enter motor nameplate data.</li> <li>2. Perform "Static Tune" or "Rotate Tune" Autotune procedure. See P70 [Autotune] on <a href="#">page 63</a></li> </ol>

**Drive does not reverse motor direction.**

Cause(s)	Indication	Corrective Action
Digital input is not selected for reversing control.	None	Check that the DI Reversing function is correctly configured.
Digital input is incorrectly wired.	None	Check digital input wiring.
Direction mode parameter is incorrectly programmed.	None	Reprogram P308 [Direction Mode], <a href="#">page 87</a> for analog "Bipolar" or digital "Unipolar" control.
Motor wiring is improperly phased for reverse.	None	Switch two motor leads.
A bipolar analog speed command input is incorrectly wired or signal is absent.	None	<ol style="list-style-type: none"> <li>1. Use meter to check that an analog input voltage is present.</li> <li>2. Check bipolar analog signal wiring.</li> </ol> Positive voltage commands forward direction. Negative voltage commands reverse direction.

**A drive stop results in a Decel Inhibit fault.**

Cause(s)	Indication	Corrective Action
The bus regulation feature is enabled and is halting deceleration due to excessive bus voltage. Excess bus voltage is normally due to excessive regenerated energy or unstable AC line input voltages. Internal timer has halted drive operation.	Decel Inhibit fault screen. LCD Status Line indicates "Faulted."	<ol style="list-style-type: none"> <li>1. To eliminate any "Adjust Freq" selection, reprogram parameters 372/373 [Bus Reg Mode <i>n</i>].</li> <li>2. Disable bus regulation (parameters 372/373 [Bus Reg Mode <i>n</i>]) and add a dynamic brake.</li> <li>3. Correct AC input line instability or add an isolation transformer.</li> <li>4. Access P409 [Dec Inhibit Actn] to select desired fault action.</li> <li>5. Reset drive.</li> </ol>

**A datalink cannot be established.**

Cause(s)	Indication	Corrective Action
Another device is communicating with the processor.	None	<ol style="list-style-type: none"> <li>1. Verify that DeviceLogix is not running (Port 14, P53 [DLX Operation] = 5 "Logic Disabled.")</li> <li>2. Verify that a PLC is not communication with the drive. Disconnect communication cable or inhibit communication in PLC software.</li> </ol>

## PowerFlex 755 Lifting/ Torque Proving

Review the Attention statement that follows if you intend to use the TorqProve™ feature without an encoder. TorqProve only applies to PowerFlex 755 drives.



**ATTENTION:** You must read the following information before you can use TorqProve with no encoder.

Encoderless TorqProve must be limited to lifting applications where personal safety is not a concern. Encoders offer additional protection and must be used where personal safety is a concern. Encoderless TorqProve cannot hold a load at zero speed without a mechanical brake and does not offer additional protection if the brake slips/fails. Loss of control in suspended load applications can cause personal injury and/or equipment damage.

It is your responsibility to configure drive parameters, test any lifting functionality and meet safety requirements in accordance with all applicable codes and standards. If encoderless TorqProve is desired, you must certify the safety of the application. To acknowledge that you have read this “Attention” and properly certified their encoderless application, bit 3 (“EnclsTrqProv”) of [Mtr Options Cfg], parameter 40 must be changed to a “1.” This action removes Alarm 28, “TP Encls Config” and allow bit 1 of Parameter 1100 to be changed to a “1” enabling encoderless TorqProve.

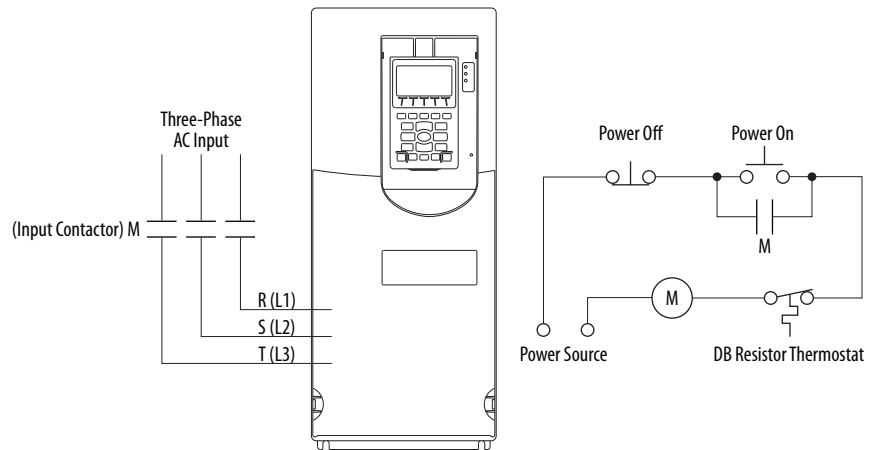
For more information on TorqProve applications, refer to [Appendix C](#) on page 455.

## External Brake Resistor



**ATTENTION:** The drive does not offer protection for externally mounted brake resistors. A risk of fire exists if external braking resistors are not protected. External resistor packages must be self-protected from over temperature or a circuit equivalent to the one shown here must be supplied.

Figure 4 - External Brake Resistor Circuitry



This circuit is designed to remove input voltage to the drive if the line voltage is high and forces dynamic braking to operate continuously.

## Technical Support Options

### What You Need When You Call Tech Support

When you contact Technical Support, please be prepared to provide the following information:

- Order number
- Product catalog number and drives series number (if applicable)
- Product serial number
- Firmware revision level
- Fault code listed in P951 [Last Fault Code]
- Installed options and port assignments

Also be prepared with:

- A description of your application
- A detailed description of the problem
- A brief history of the drive installation
- First-time installation, product has not been running
- Established installation, product has been running

The data that is contained in the following parameters help in initial troubleshooting of a faulted drive. You can use this table to record the data provided in each parameter listed.

Parameter(s)	Name	Description	Parameter Data
956	Fault Frequency	Captures and displays the output speed of drive at time of last fault.	
957	Fault Amps	Captures and displays motor amps at time of last fault.	
958	Fault Bus Volts	Captures and displays the DC bus voltage of drive at time of last fault.	
954	Status1 at Fault	Captures and displays [Drive Status 1] bit pattern at time of last fault.	
955	Status2 at Fault	Captures and displays [Drive Status 2] bit pattern at time of last fault.	
962	AlarmA at Fault	Captures and displays [Alarm Status A] bit pattern at time of last fault.	
963	AlarmB at Fault	Captures and displays [Alarm Status B] bit pattern at time of last fault.	
951	Last Fault Code	A code that represents the fault that tripped the drive.	

## Technical Support Wizards

When you are connected to a drive via DriveExplorer or DriveExecutive, you can run a Tech Support wizard to gather information that helps diagnose problems with your drive and/or peripheral device. The wizard gathers information and saves the data as a text file. This file can be emailed to your remote technical support contact.

To run a Tech Support wizard in DriveExplorer, select **Wizards** from the **Actions** menu. In DriveExecutive, select **Wizards** from the **Tools** menu. Or, click the



button. Follow the prompts to complete the wizard.

---

**IMPORTANT** The Tech Support wizard cannot be accessed when the Control Bar is launched.

---

## PowerFlex 753 Control Block Diagrams

The block diagrams in this appendix are applicable to firmware revision 11.002 and earlier only.

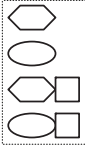
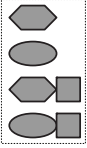

Flow diagrams on the following pages illustrate the PowerFlex 753 drive control algorithms.

<b>Diagram</b>	<b>Page</b>
Flux Vector Overview	377
VF, SV Overview	378
Speed/Position Feedback	379
Speed Control - Reference Overview	380
Speed Control - Reference (1)	381
Speed Control - Reference (2)	382
Speed Control - Reference (3)	383
Speed Control - Reference (4)	384
Speed Control - Reference (5)	385
Speed Control - Regulator (FV)	386
Position Control - Reference	387
Position Control - Regulator	388
Position Control - Aux Functions	389
Position Control - Homing	390
Torque Control - Overview (IM)	391
Torque Control - Overview (IPM)	392
Torque Control - Reference Scale & Trim	393
Torque Control - Torque	394
Torque Control - Current (IM)	395
Torque Control - Current (IPM)	396
Process Control (1)	397
Process Control (2)	398
MOP Control	399
Embedded Inputs & Outputs - Digital	400
Embedded Inputs & Outputs - Analog	401
22-Series Option Inputs & Outputs - Digital	402
22-Series Option Inputs & Outputs - Analog	403
11-Series Inputs & Outputs - Digital	404
11-Series Inputs & Outputs - Analog	405
11-Series Inputs & Outputs - ATEX	406
Control Logic	407
Inverter Overload IT	408
Variable Boost Voltage Overview	409

## Diagram Conventions and Definitions

*Definitions of the Per Unit system:*  
 1.0 PU Position = Distance traveled / 1sec at Base Spd  
 1.0 PU Speed = Base Speed of the Motor  
 1.0 PU Torque = Base Torque of the Motor

**Symbol Legend:**

 <p>Drive Parameters</p>	 <p>Option Module Parameters</p>	<p>→ Requires port number.</p>
		Read Only Parameter
		Read / Write Parameter
		Read Only Parameter with Bit Enumeration
		Read / Write Parameter with Bit Enumeration
		Provides additional information
<p>( ) = Enumerated Parameter          [ ] = Page and Coordinate          ex. 3A2 = pg 3, Column A, Row 2          □ = Constant value</p>		
<p>'d' = Prefix refers to Diagnostic Item Number          ex. d33 = Diagnostic Item 33</p>		

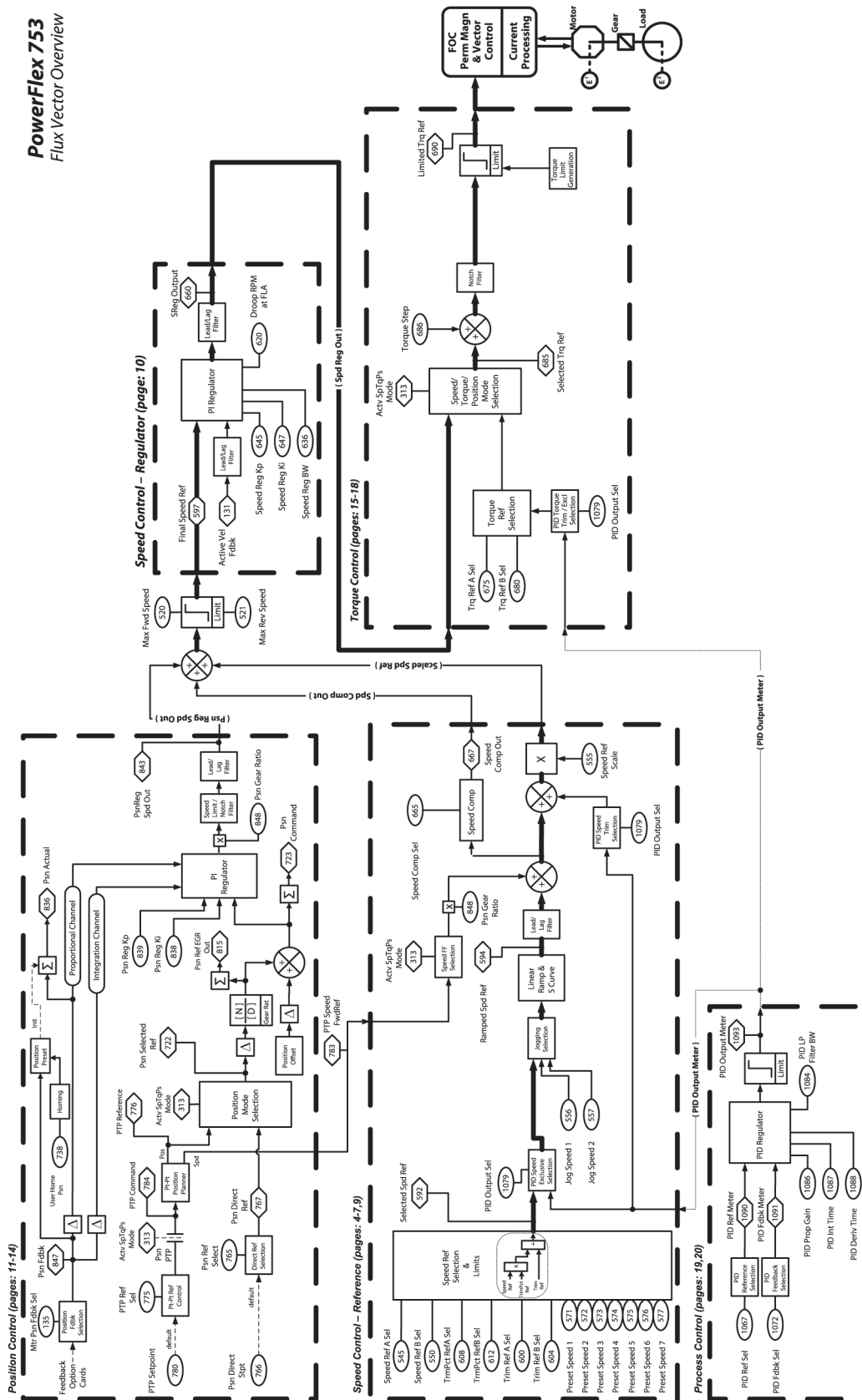
**\* Notes, Important :**

(1) These diagrams are for reference only and may not accurately reflect all logical control signals; actual functionality is implied by the approximated diagrams. Accuracy of these diagrams is not guaranteed.



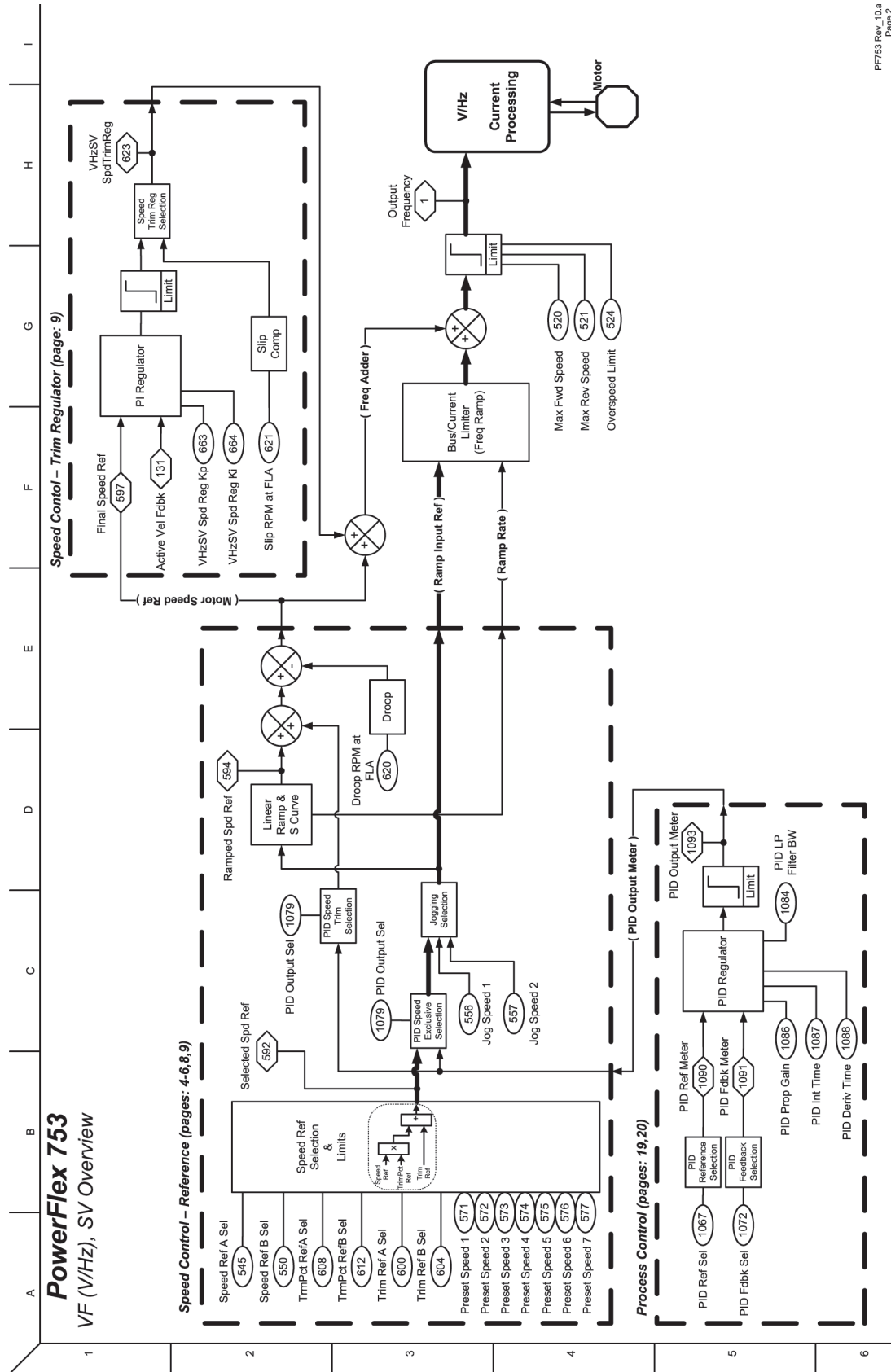
**PowerFlex 753**  
Flux Vector Overview

**Figure 5 - Flux Vector Overview**



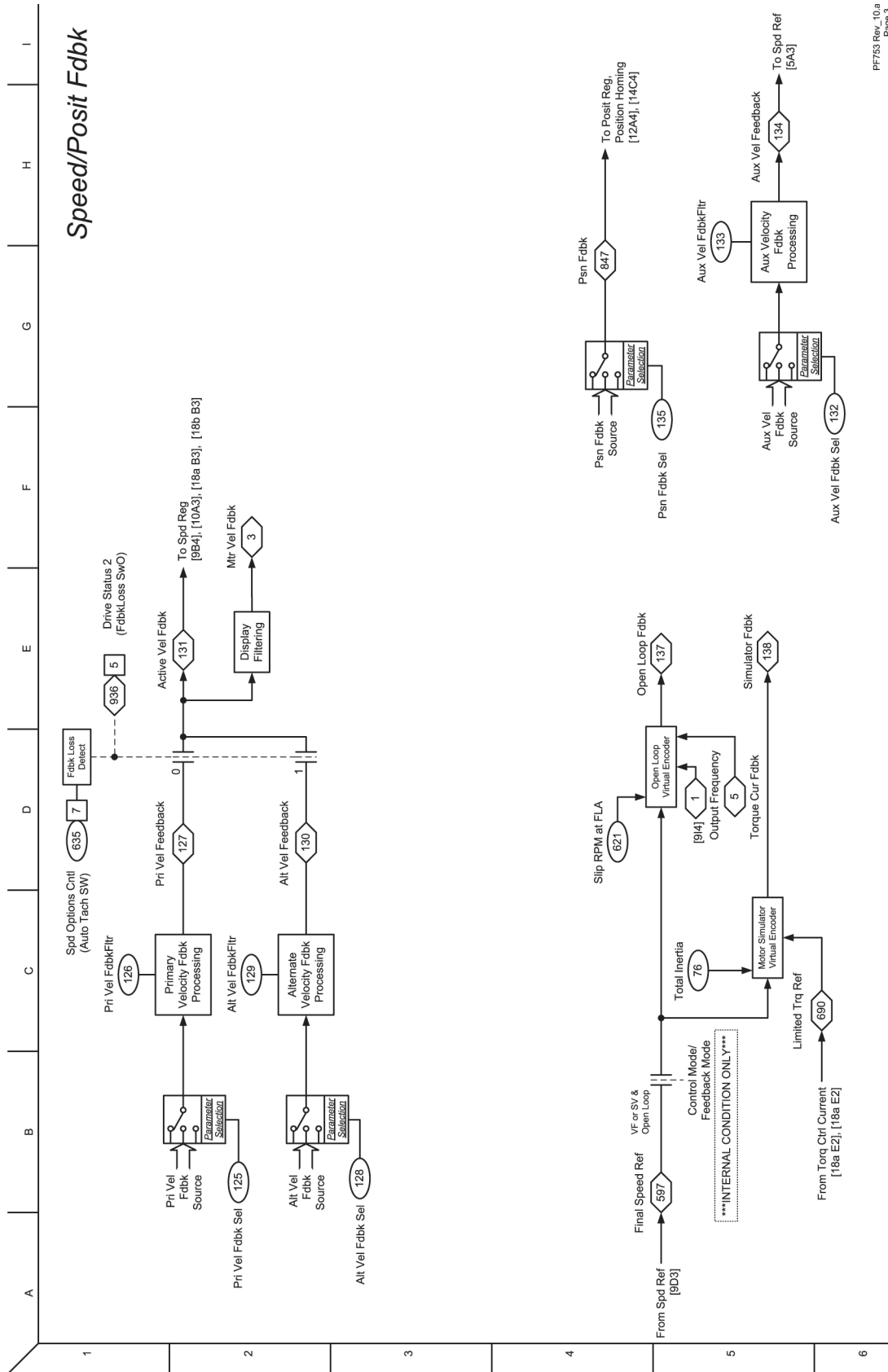
PF753 Rev. 10a  
Page 1

Figure 6 - VF, SV Overview



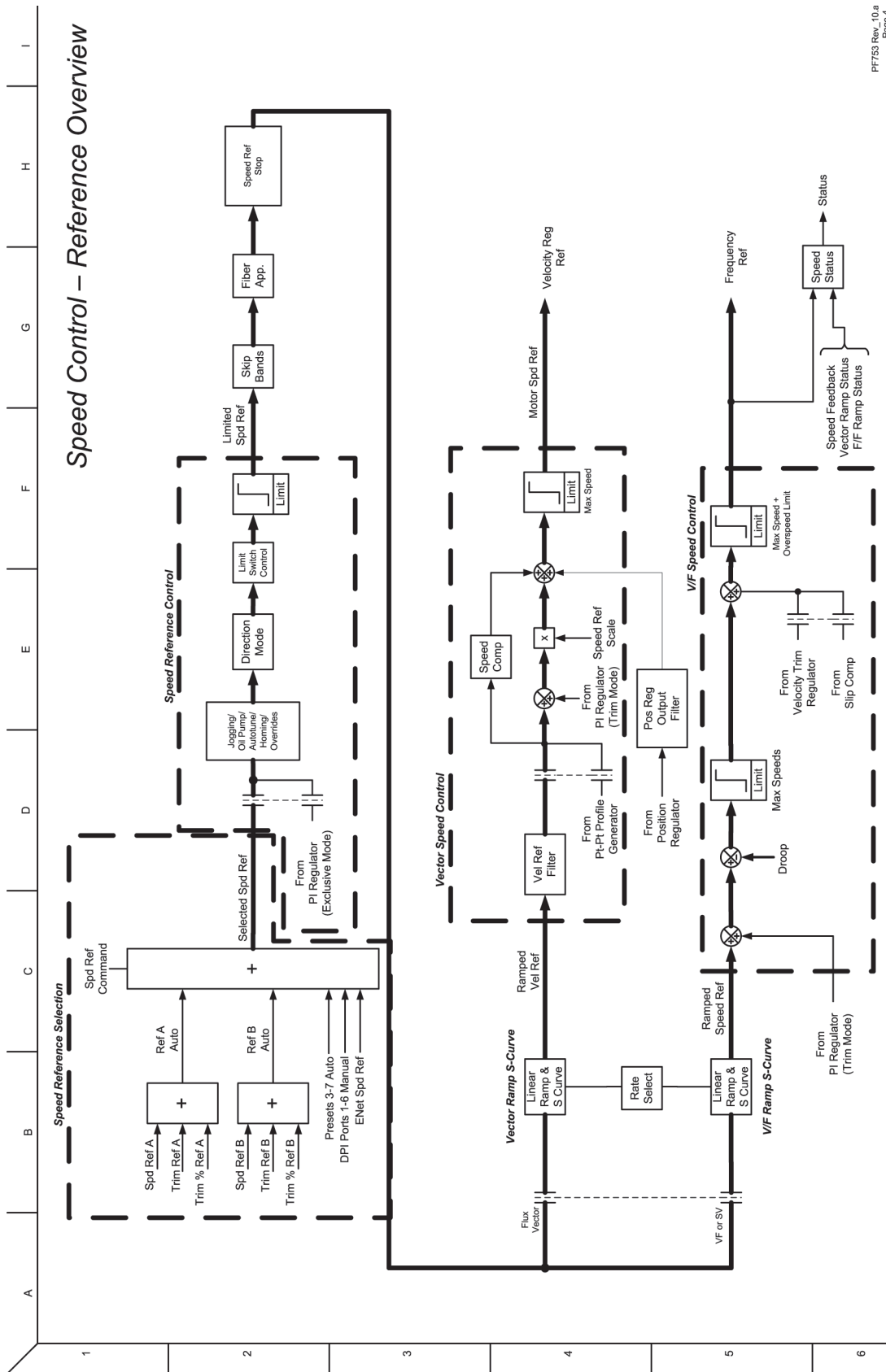
PF753 Rev\_10.a  
Page 2

**Figure 7 - Speed/Position Feedback**



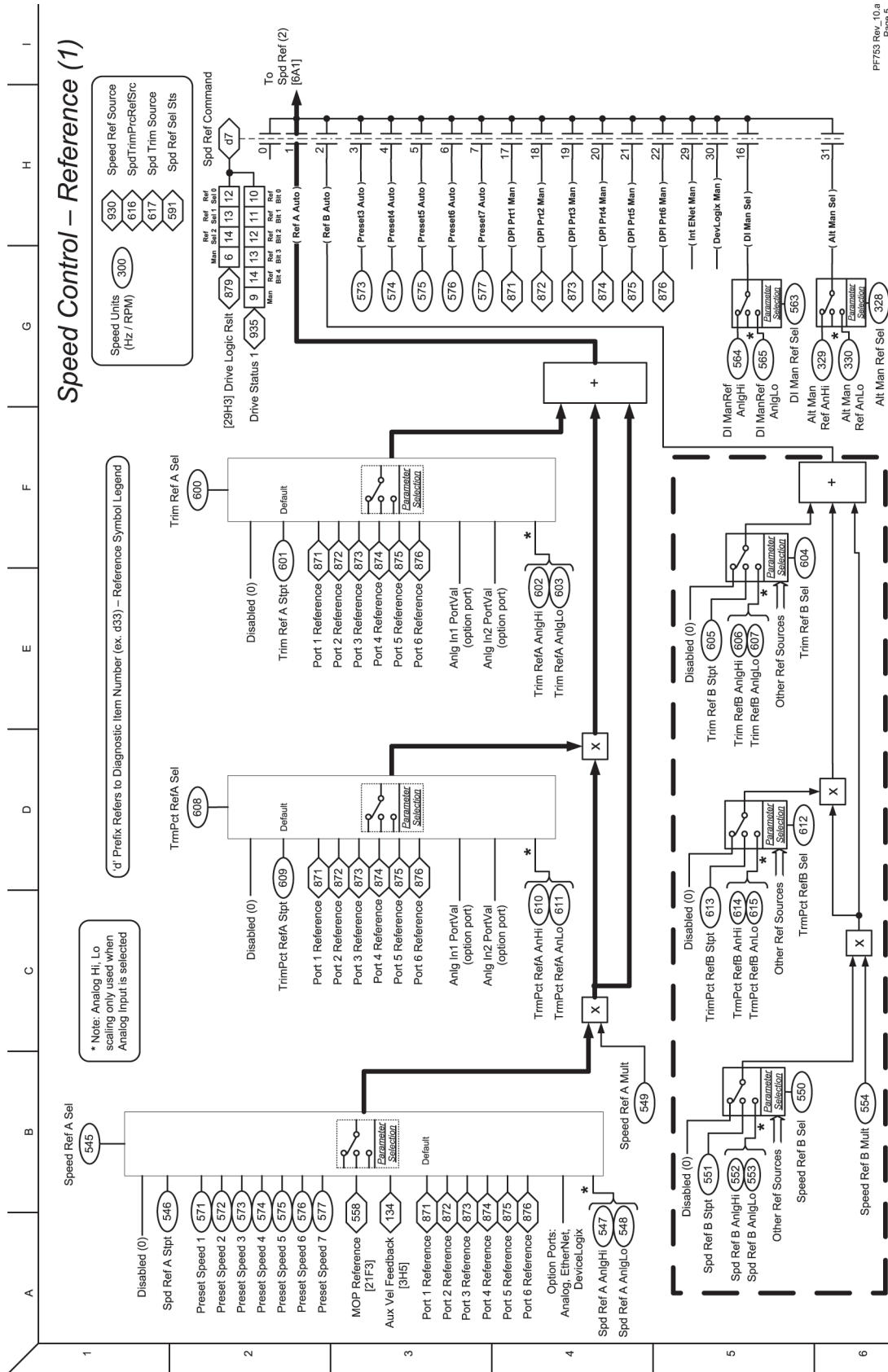
PF753 Rev\_10.a  
Page 3

Figure 8 - Speed Control - Reference Overview



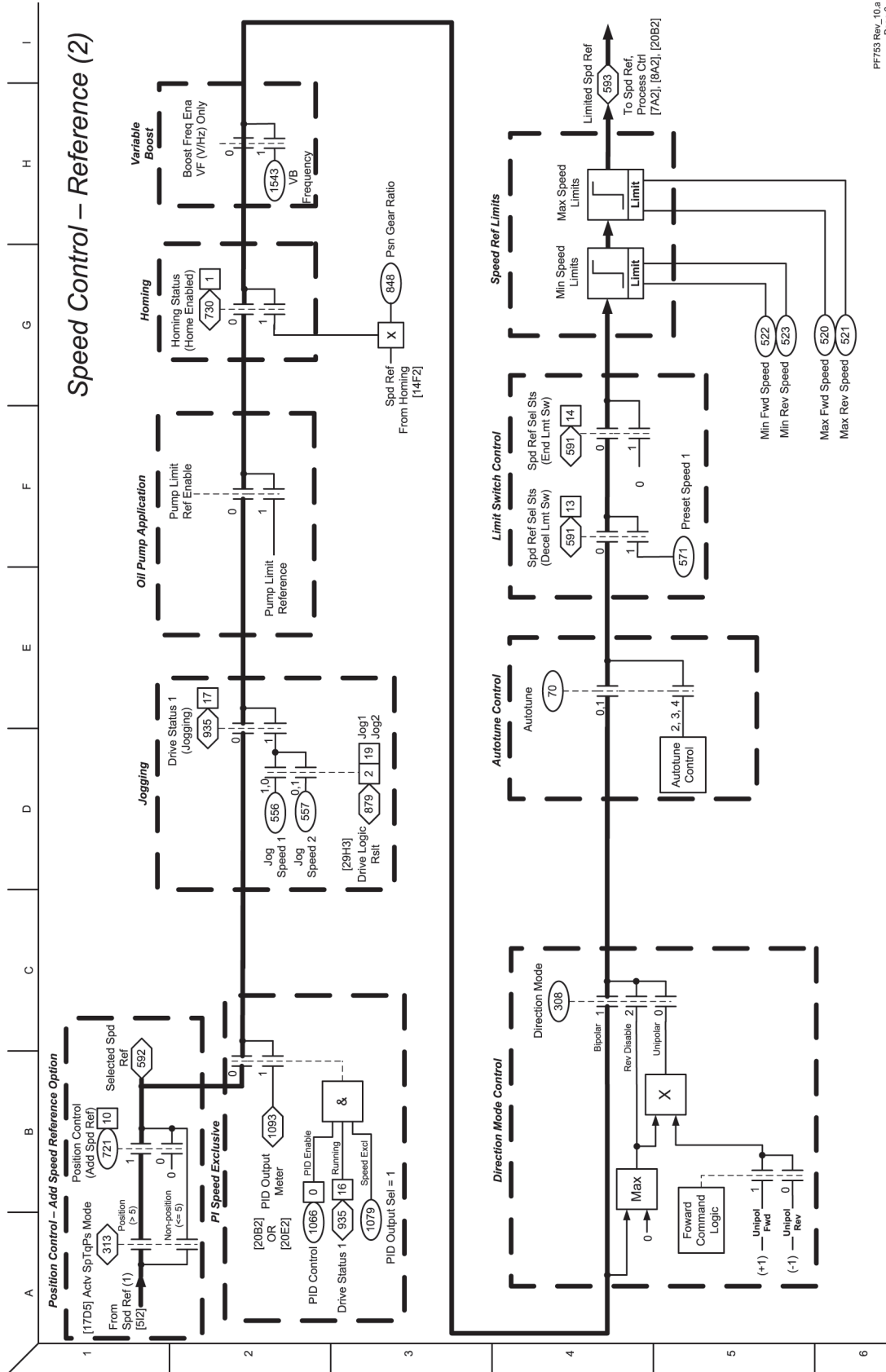
PF753 Rev. 10.0  
Page 4

Figure 9 - Speed Control - Reference (1)



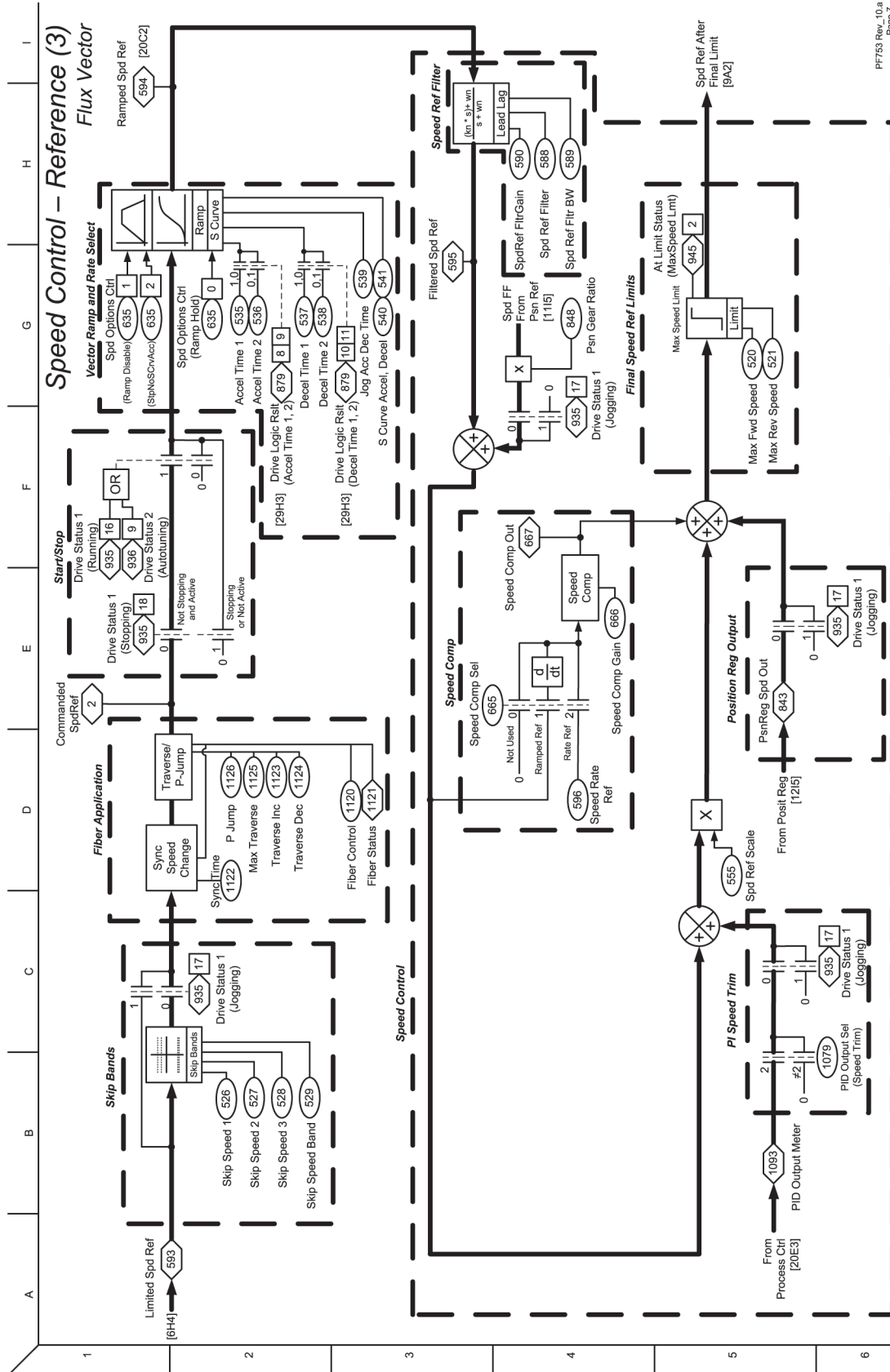
PFF753\_Rev\_10.a  
Page 5

Figure 10 - Speed Control - Reference (2)



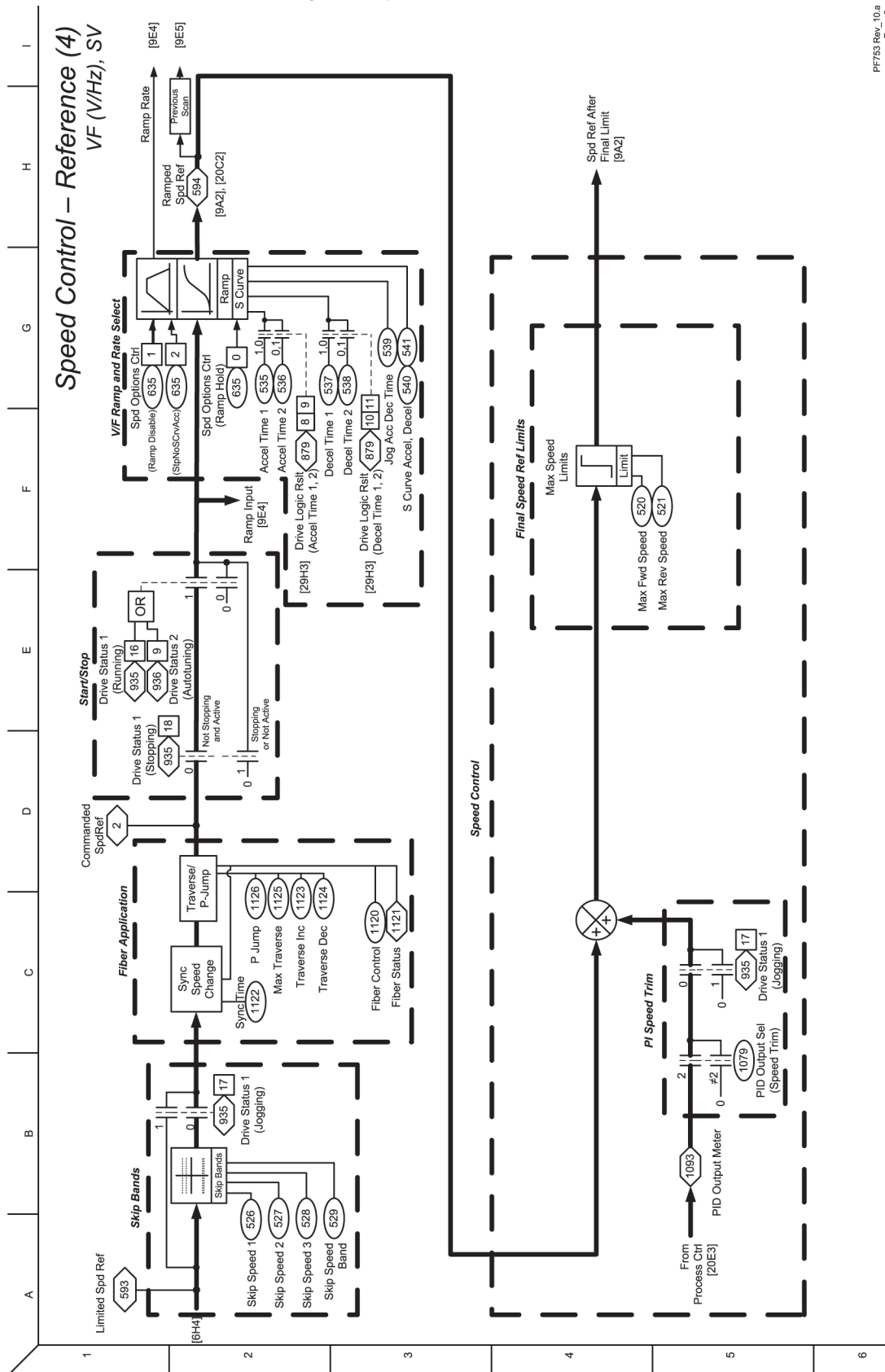
PF753 Rev\_10.a  
Page 6

Figure 11 - Speed Control - Reference (3)



PFF753 Rev. 10.a  
Page 7

Figure 12 - Speed Control - Reference (4)







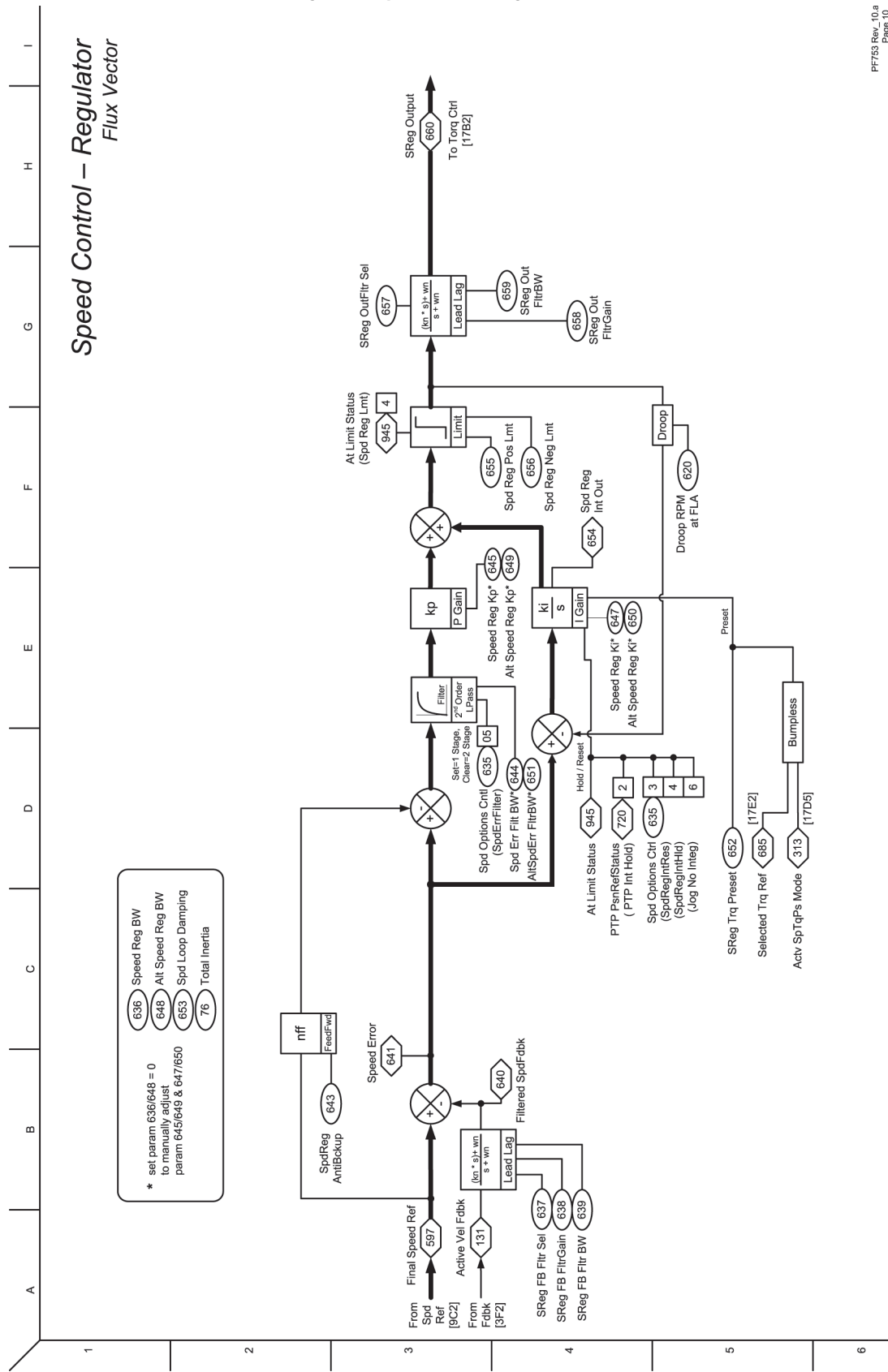
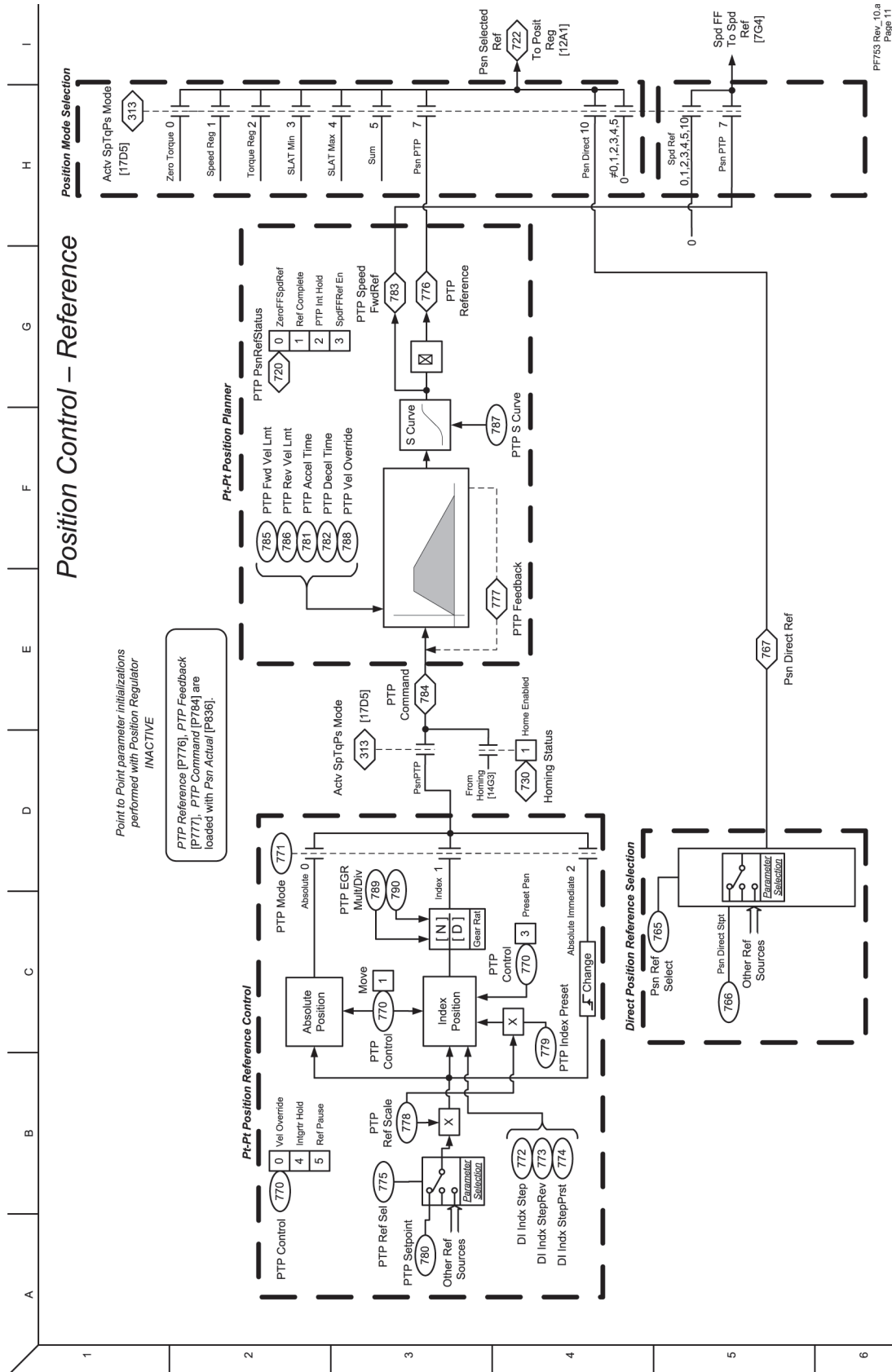
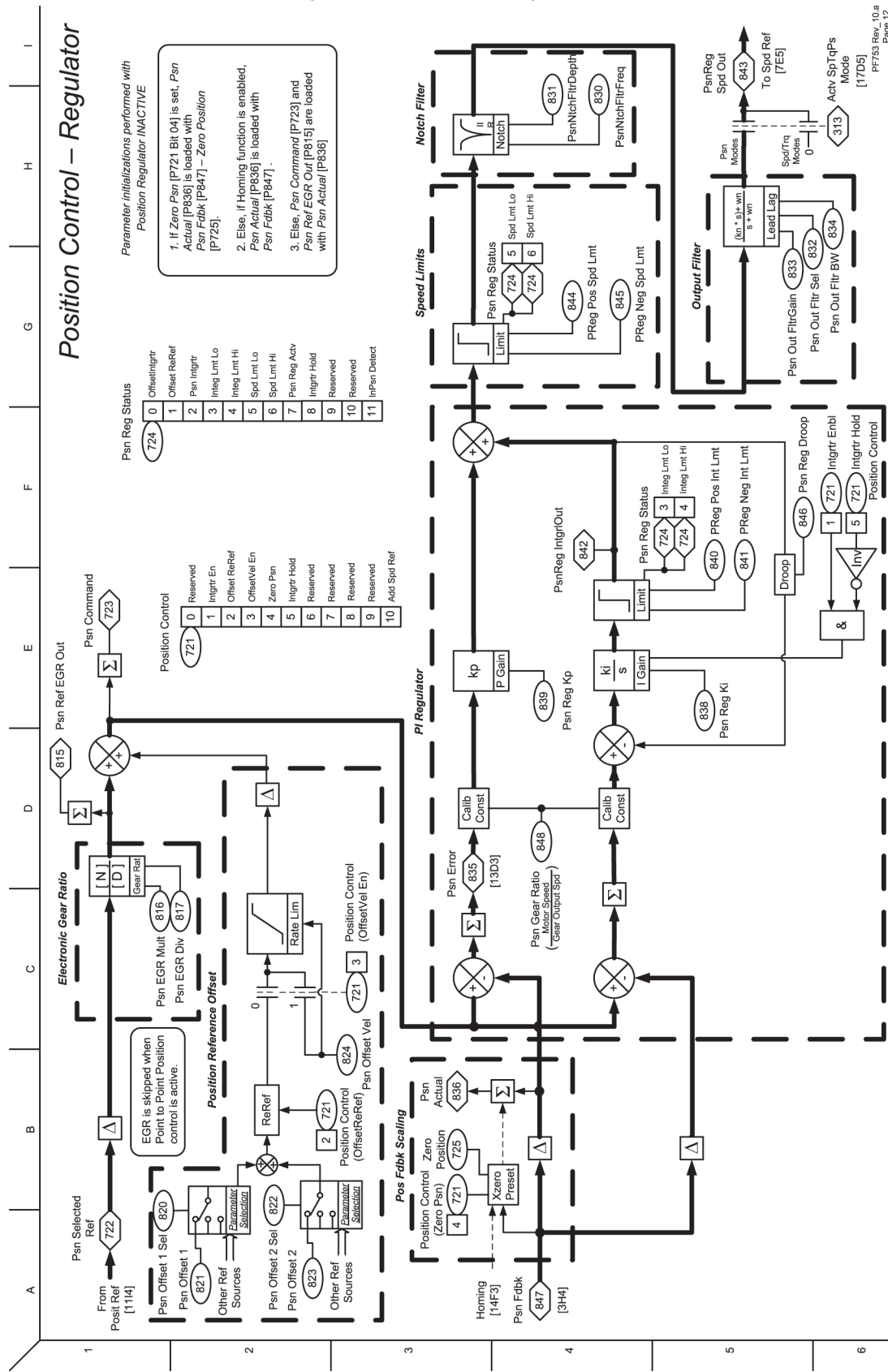


Figure 15 - Position Control - Reference

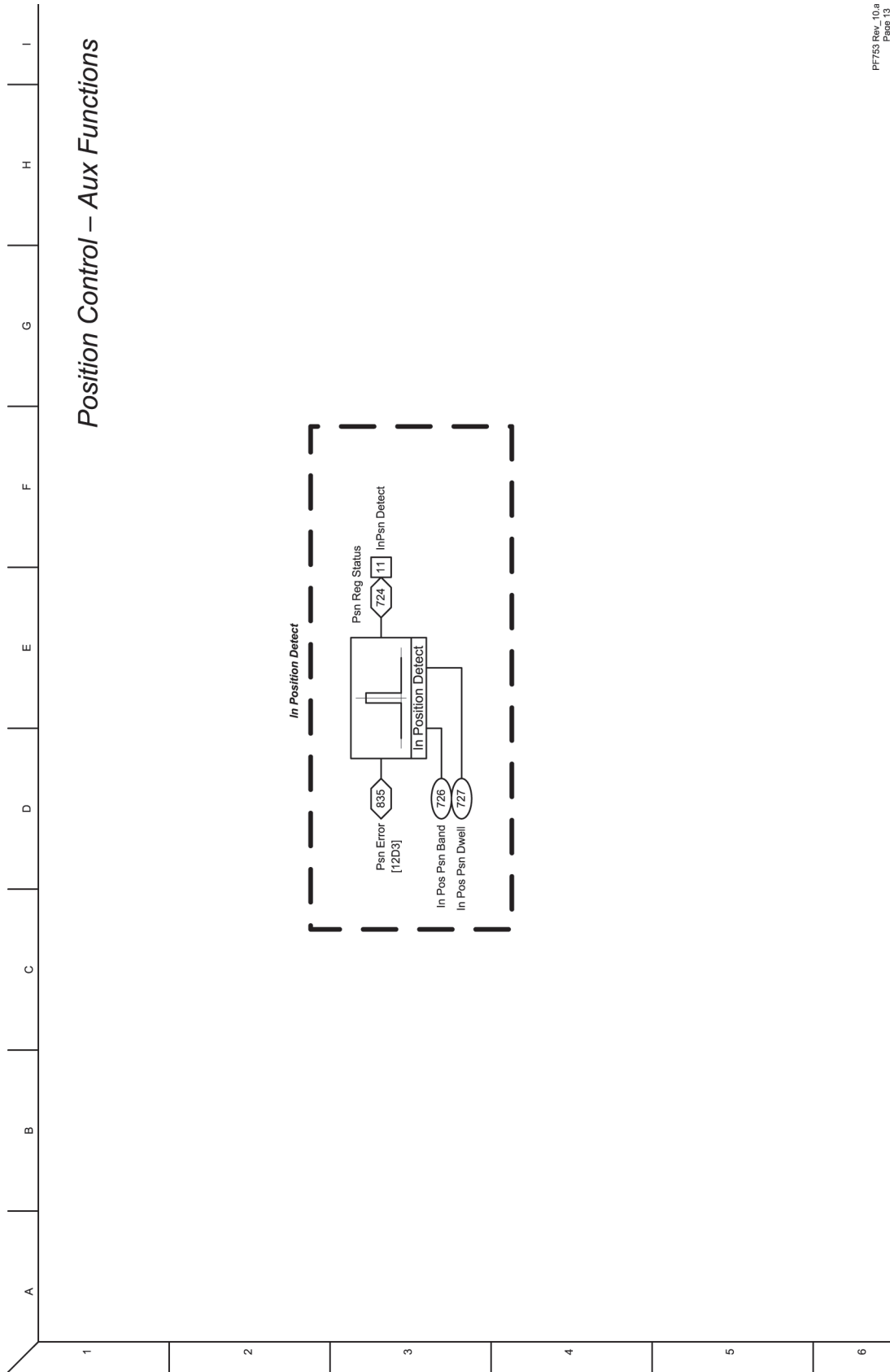


PTF53 Rev. 10.a  
Page 11

Figure 16 - Position Control - Regulator

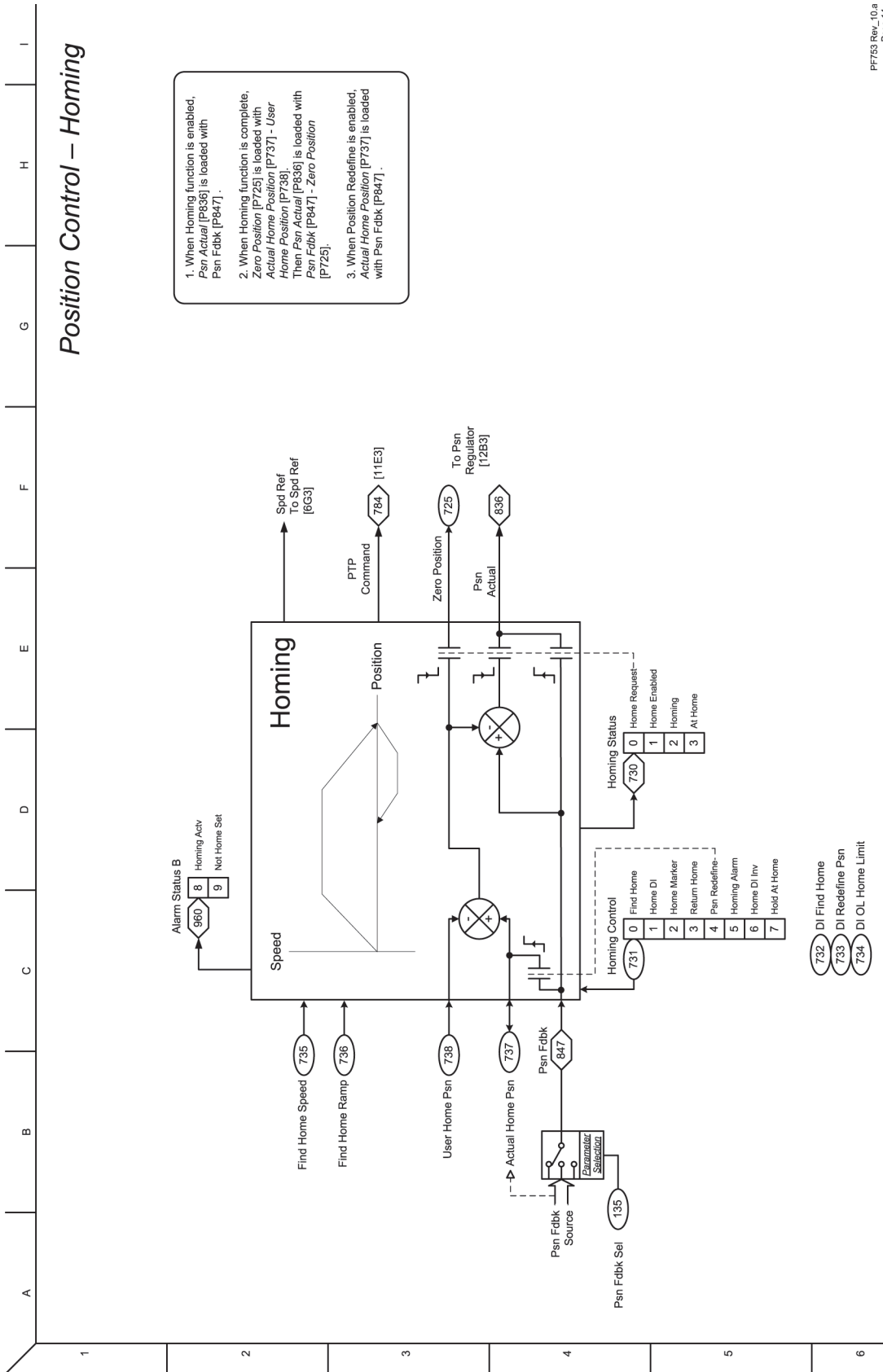


**Figure 17 - Position Control - Aux Functions**



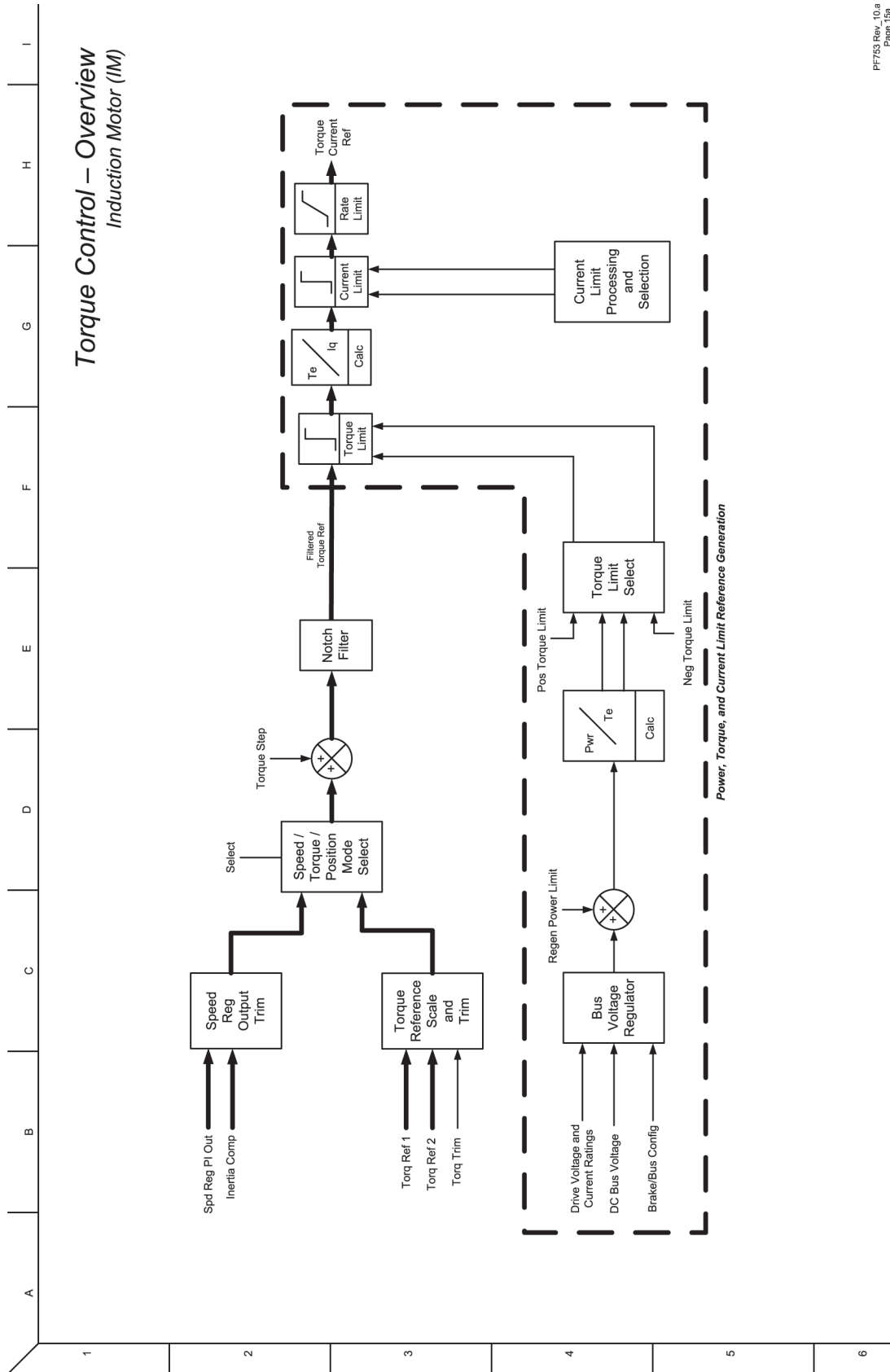
PF753 Rev\_10.a  
Page 13

Figure 18 - Position Control - Homing



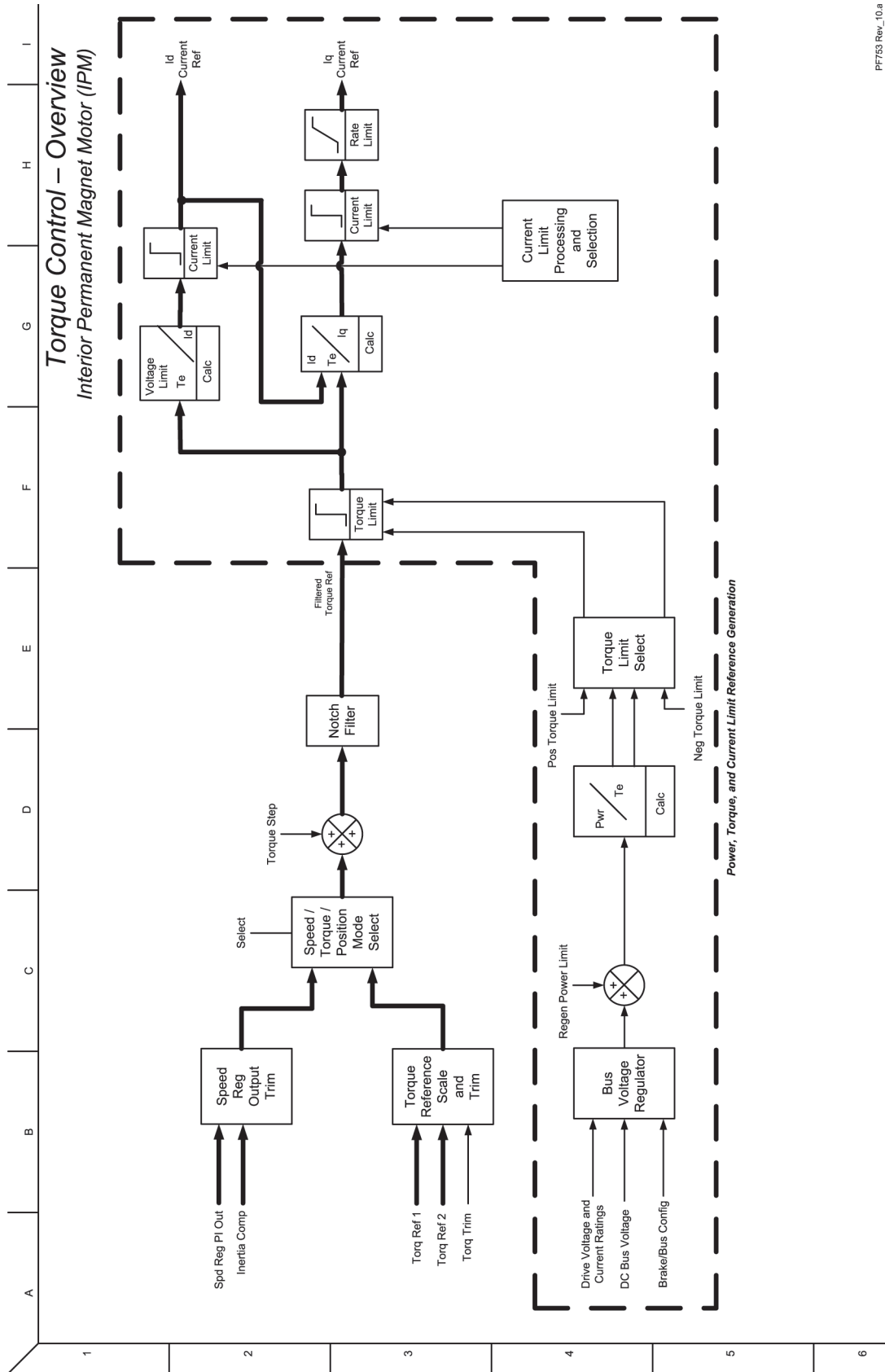
PF753 Rev\_10.a  
Page 14

**Figure 19 - Torque Control - Overview (IM)**



PF753 Rev. 10.a  
Page 108

Figure 20 - Torque Control - Overview (IPM)

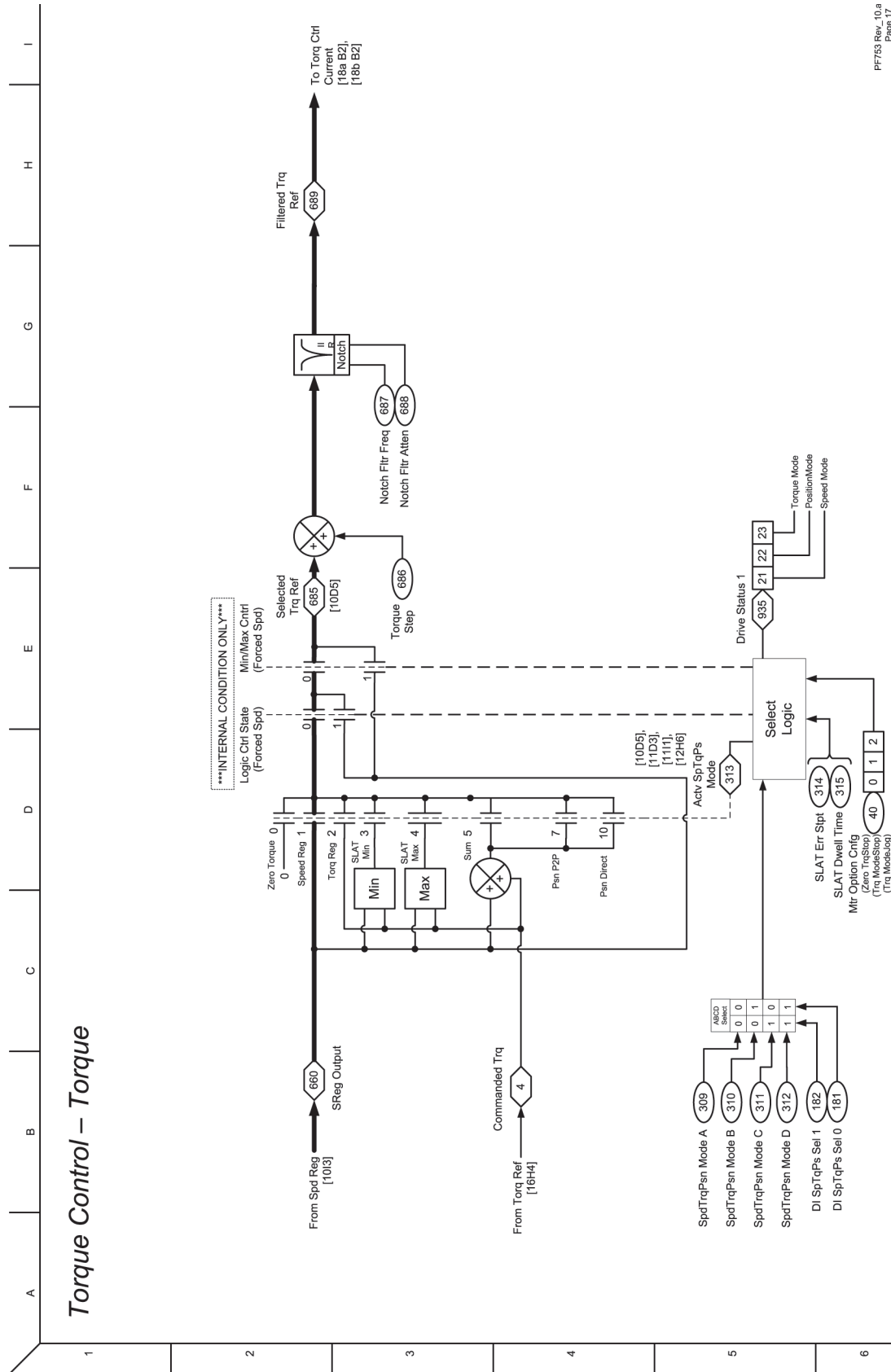


PF753\_Rev\_10.a  
Page 15b



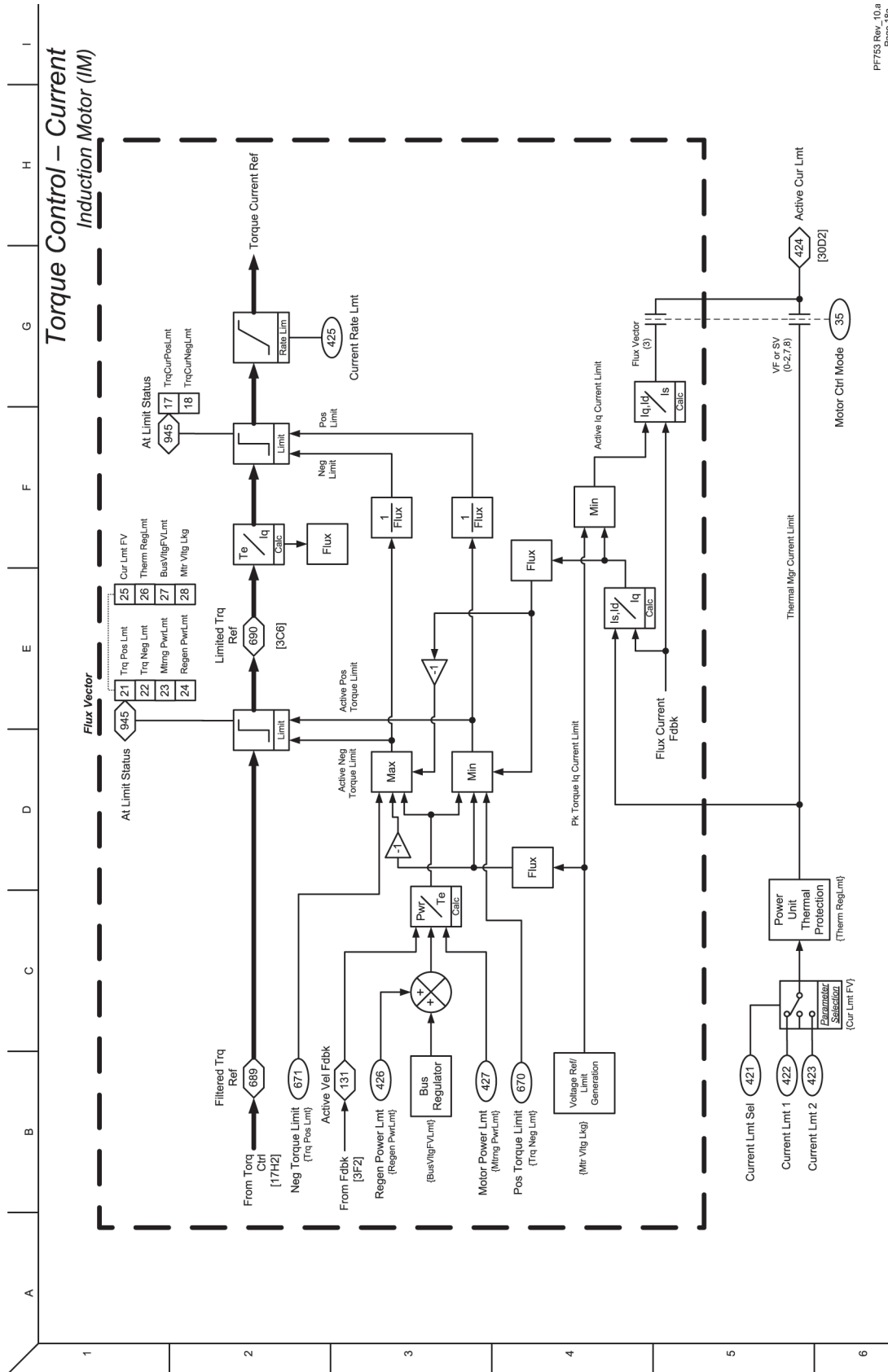


Figure 22 - Torque Control - Torque



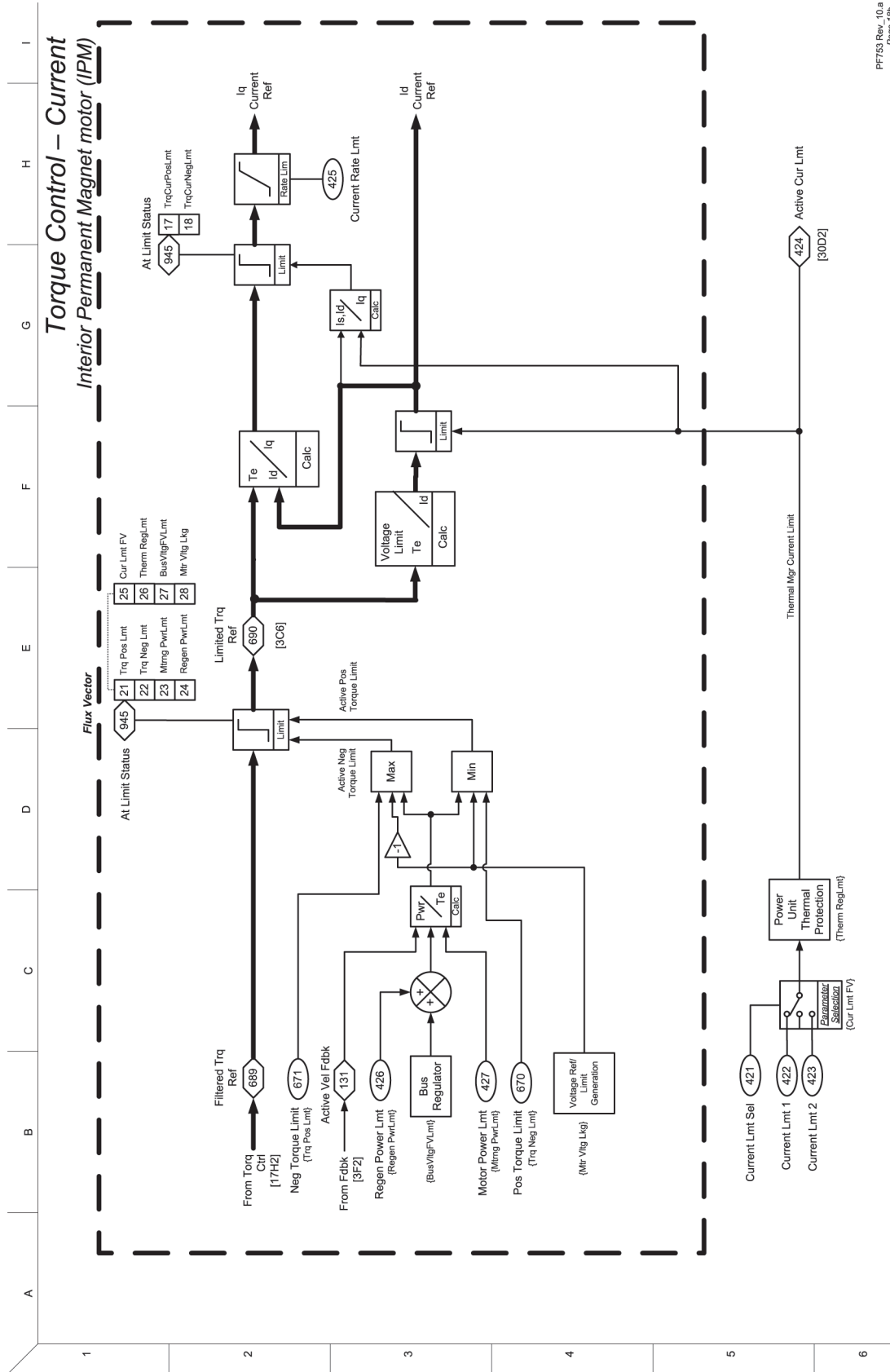
PF753 Rev. 10.a  
Page 17

Figure 23 - Torque Control - Current (IM)



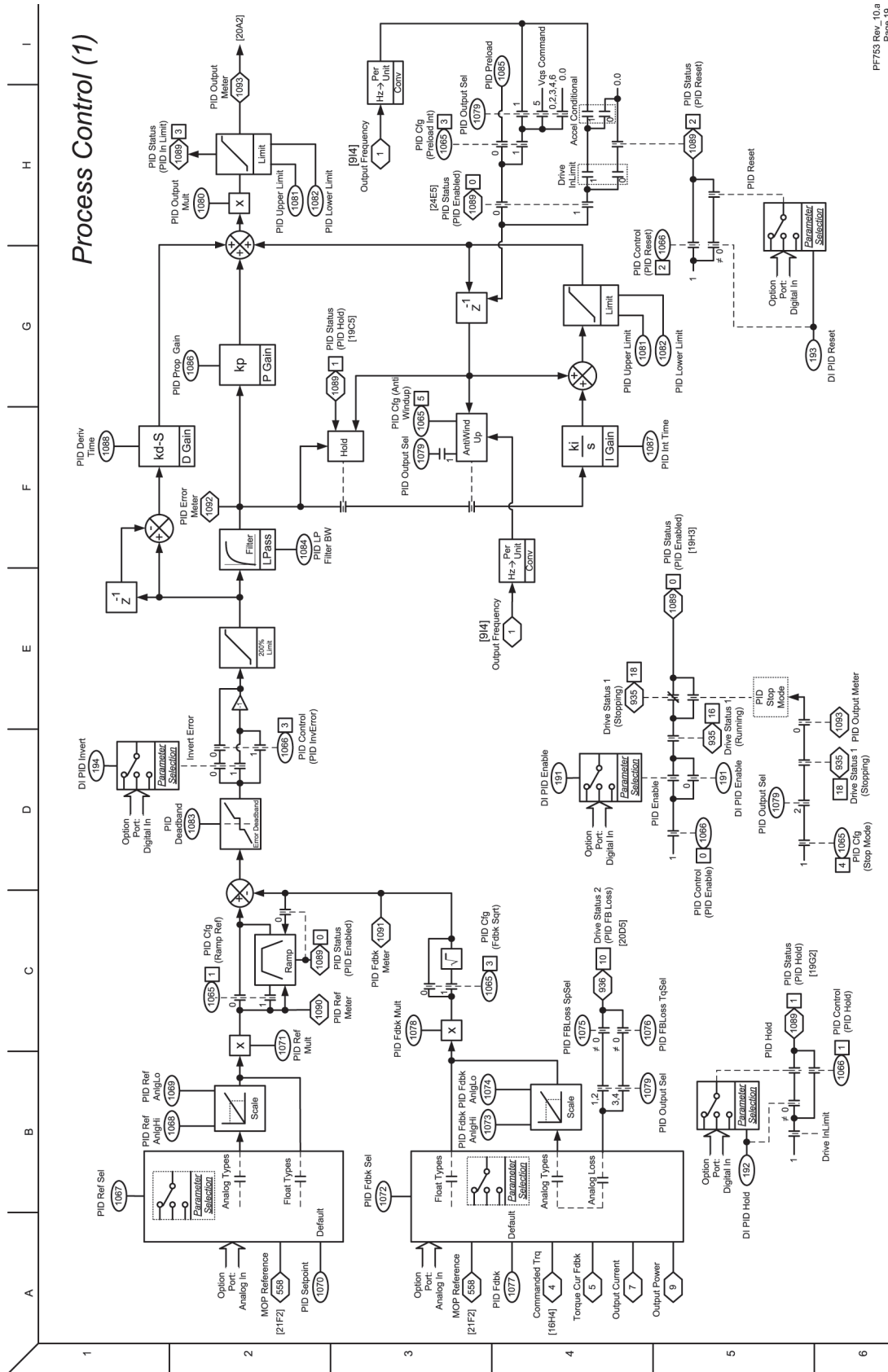
PF753 Rev. 10.a  
Page 108

Figure 24 - Torque Control - Current (IPM)



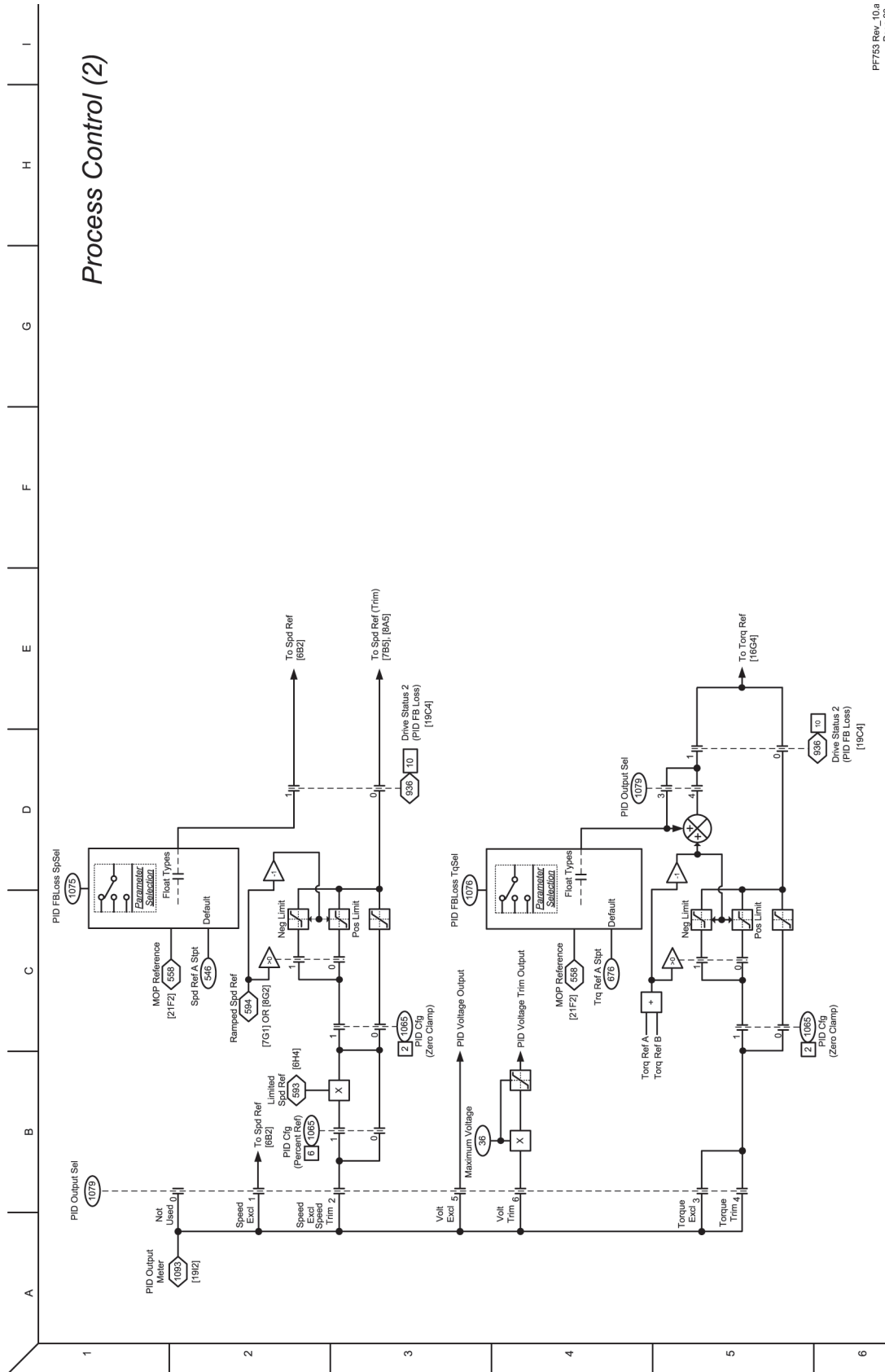
PF753 Rev. 10.a  
Page 16b

Figure 25 - Process Control (1)



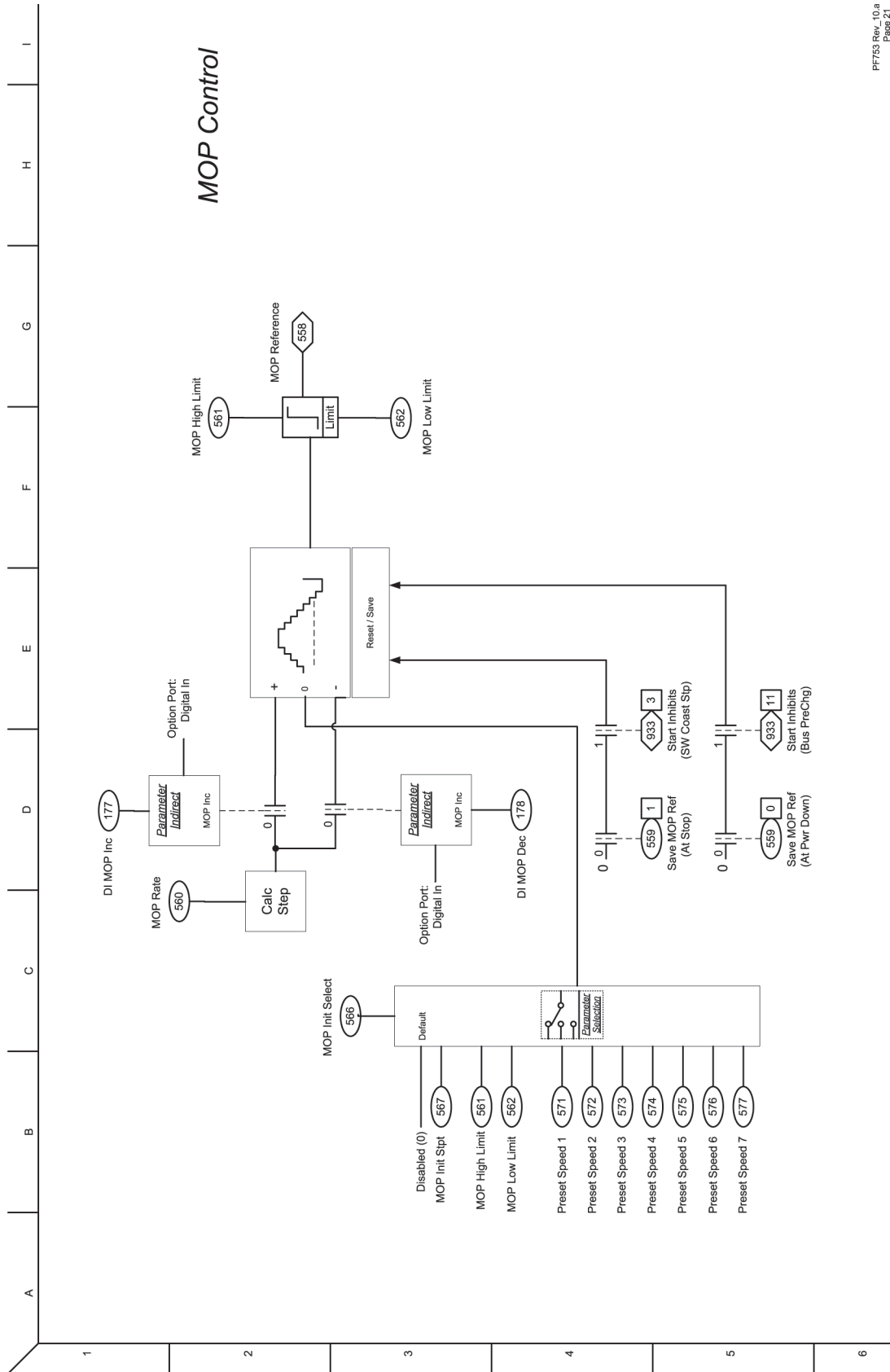
PF753 Rev\_10.a  
Page 19

Figure 26 - Process Control (2)



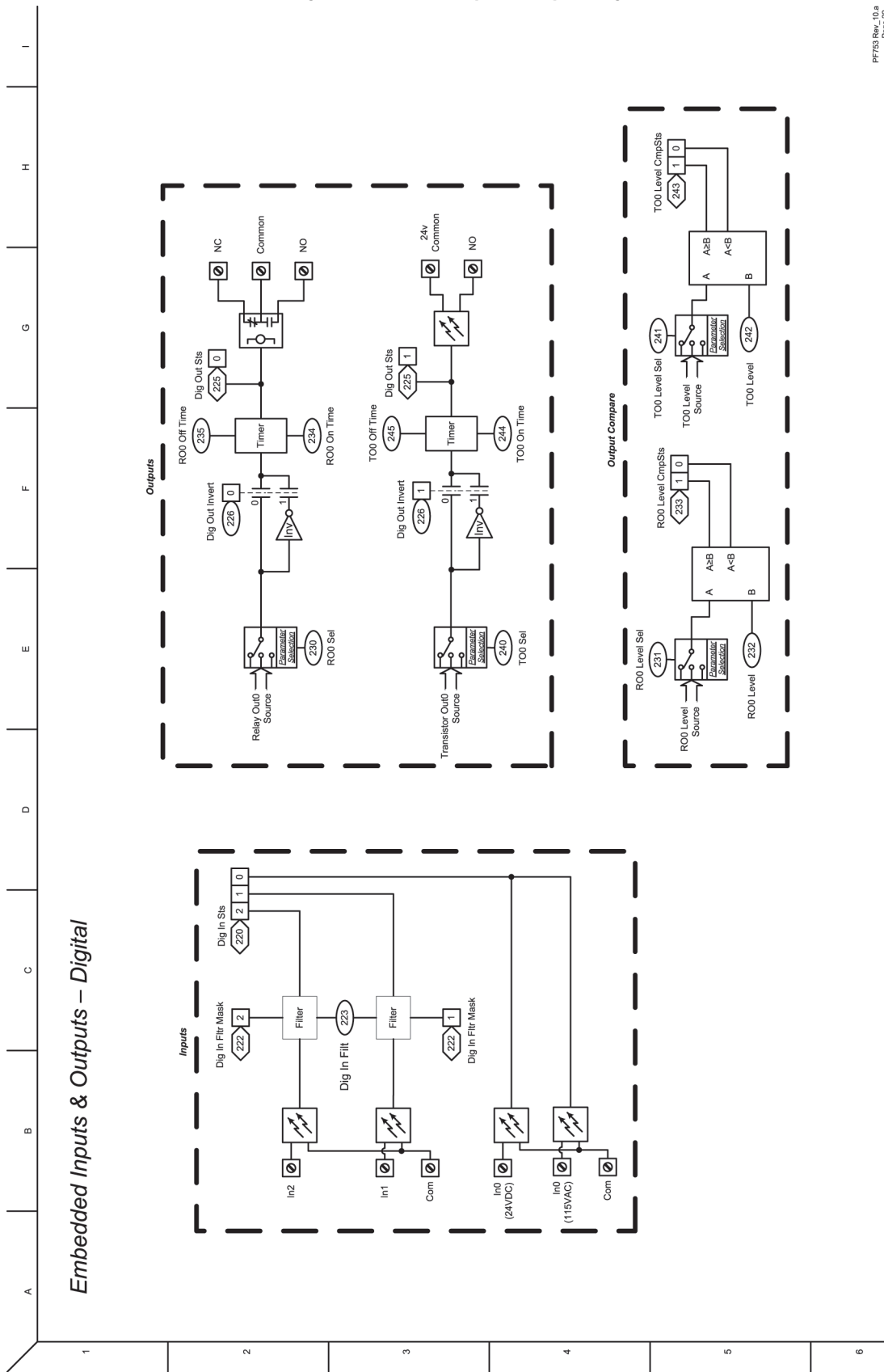
PF753 Rev\_10.a  
Page 20

**Figure 27 - MOP Control**



PFF753 Rev\_10.a  
Page 21

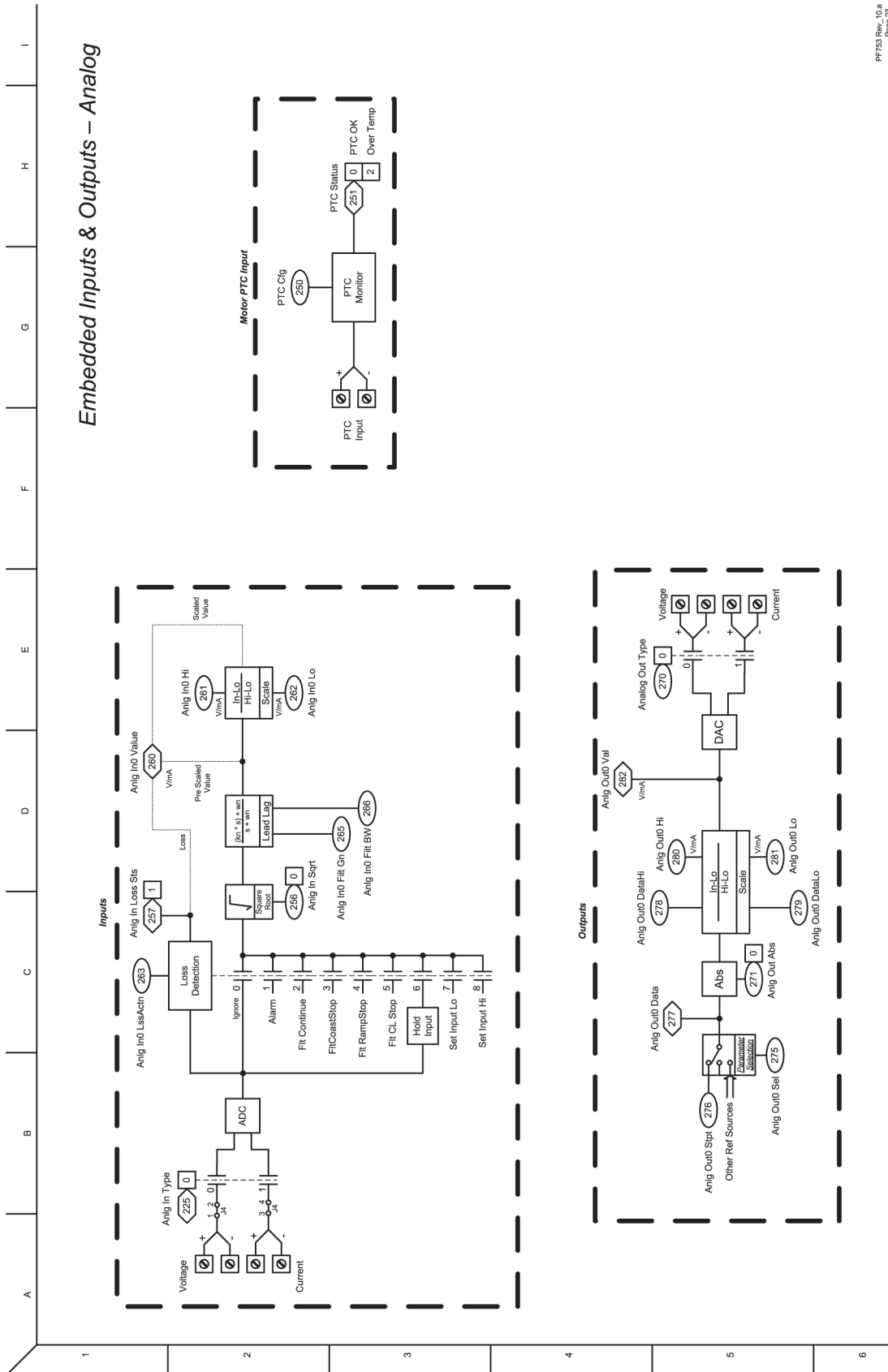
Figure 28 - Embedded Inputs & Outputs - Digital



PF753 Rev\_10.a  
Page 22



**Figure 29 - Embedded Inputs & Outputs - Analog**



PF753 Rev\_10.a  
Page 23

Figure 30 - 22-Series Option Inputs & Outputs - Digital

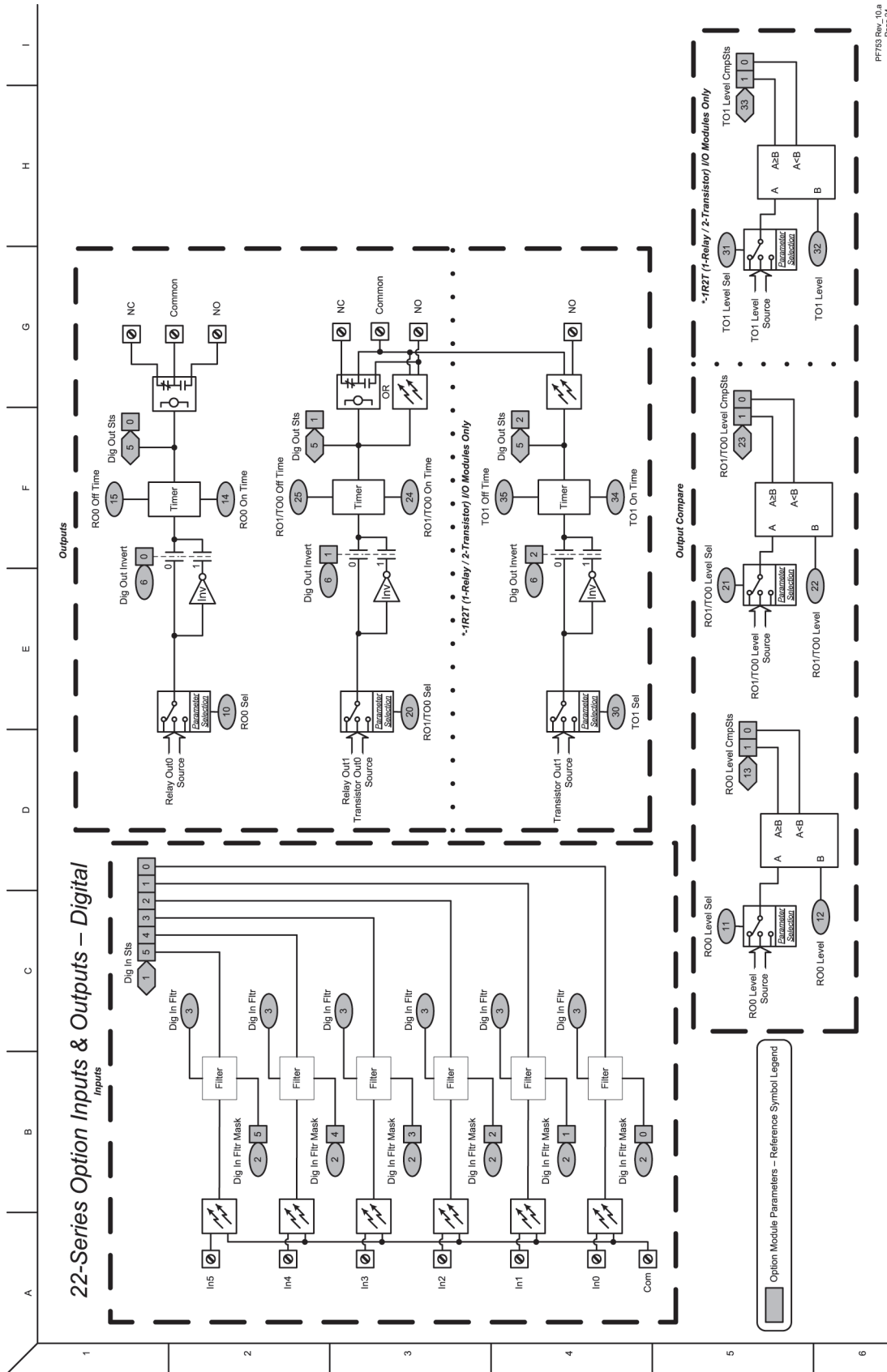


Figure 31 - 22-Series Option Inputs & Outputs - Analog

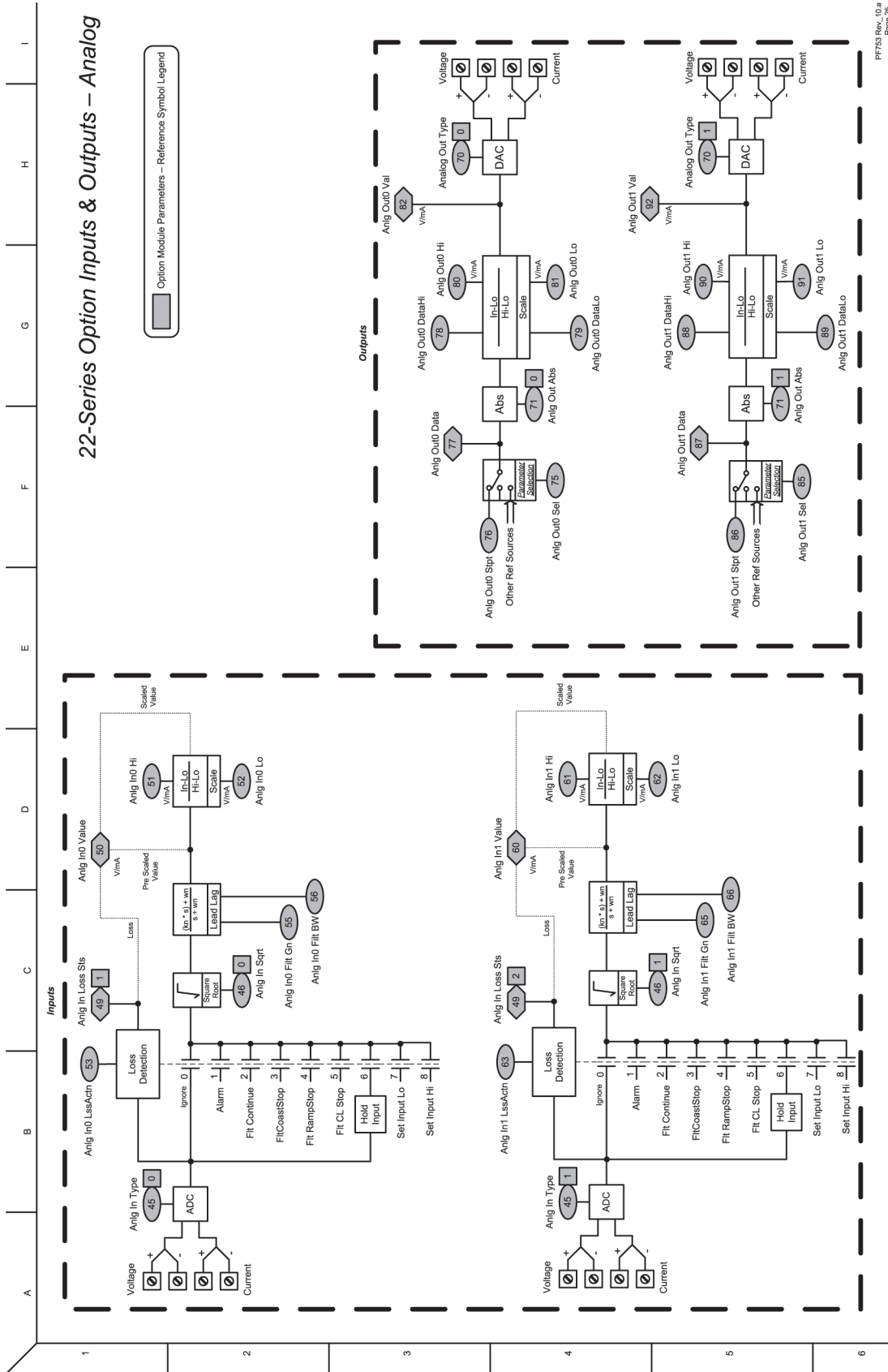
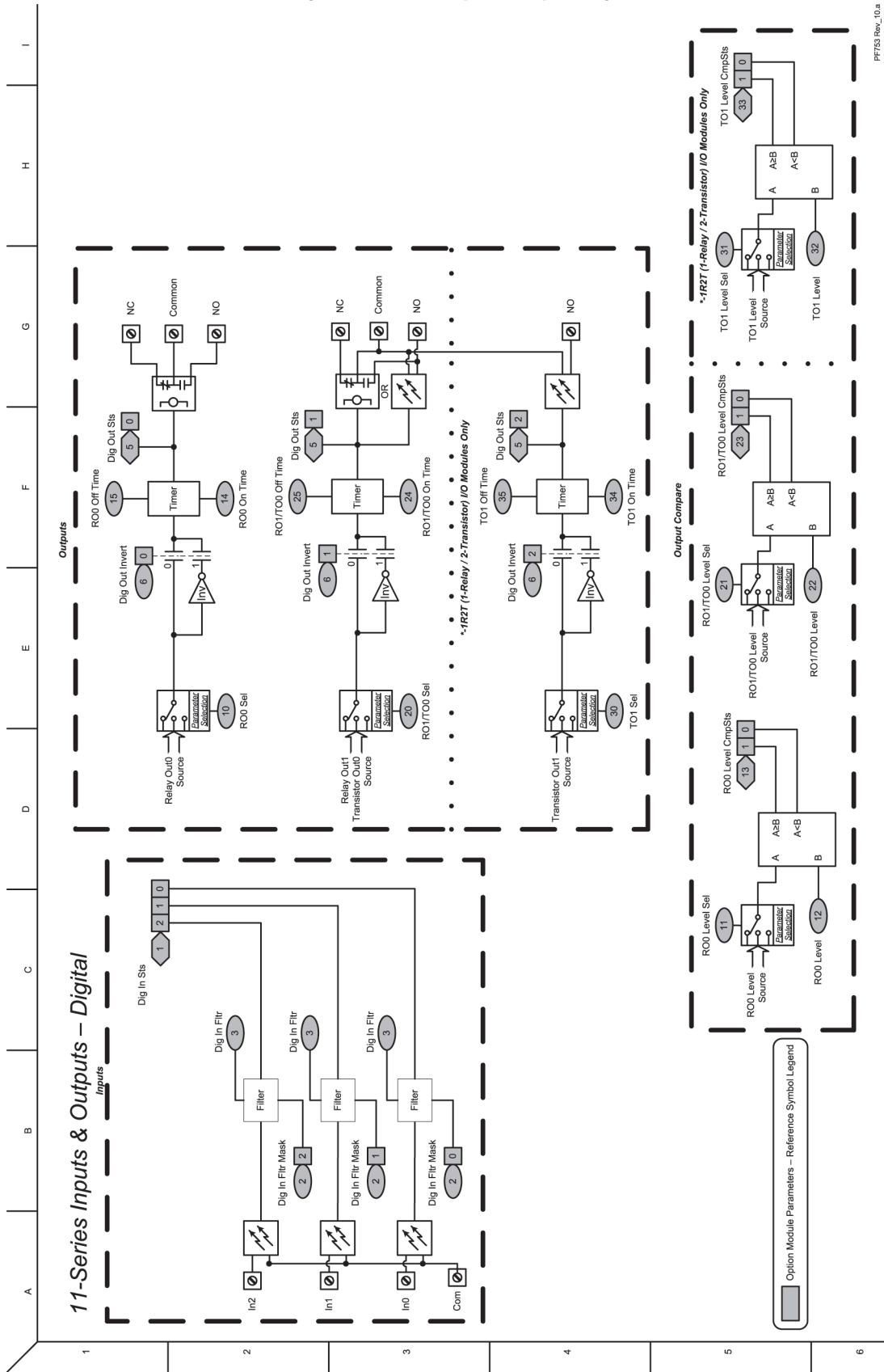
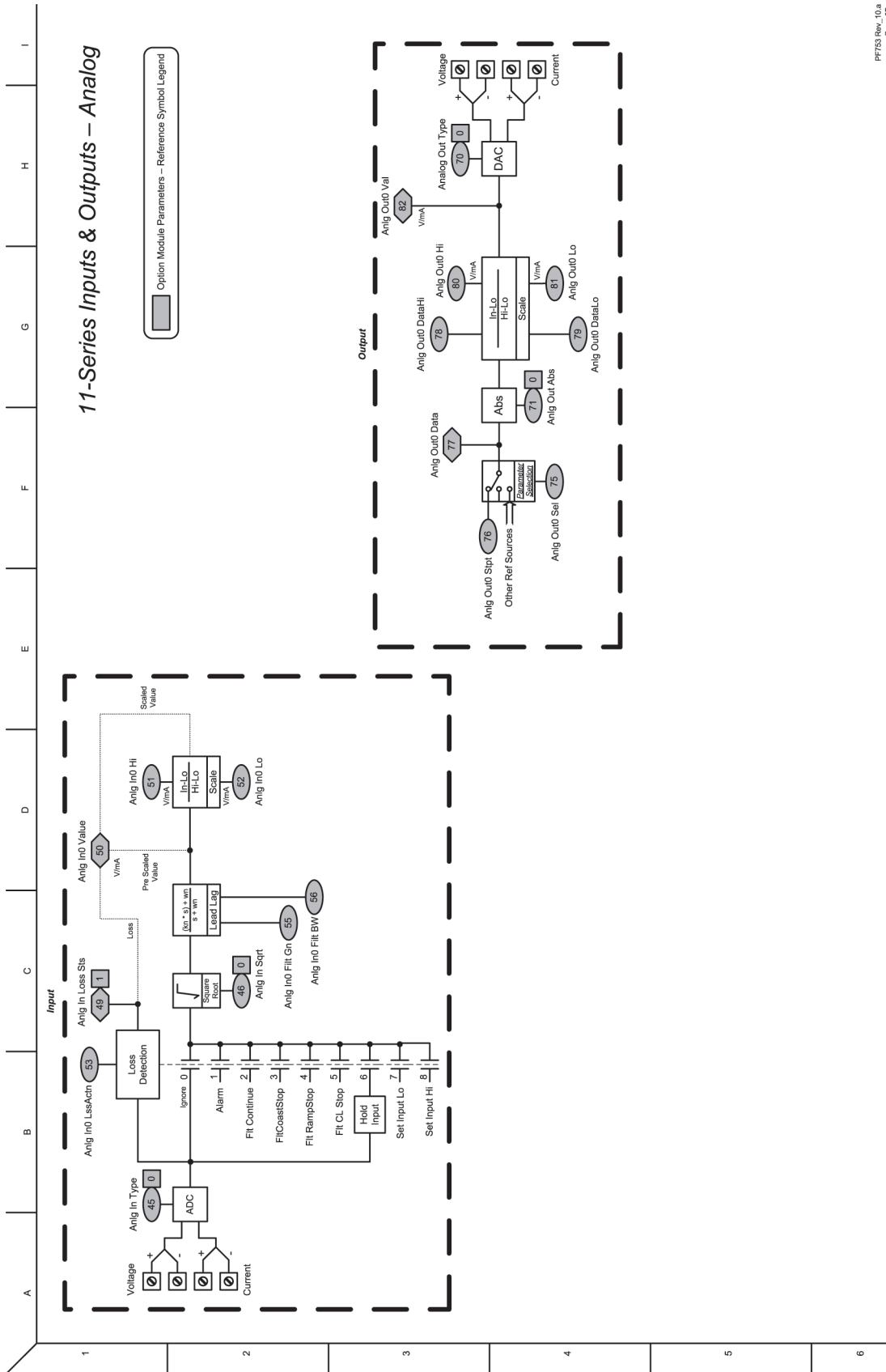


Figure 32 - 11-Series Inputs & Outputs - Digital



PF753 Rev\_10.a  
Page 26

**Figure 33 - 11-Series Inputs & Outputs - Analog**



PF753 Rev. 10.0  
Page 27

Figure 34 - 11-Series Inputs & Outputs - ATEX

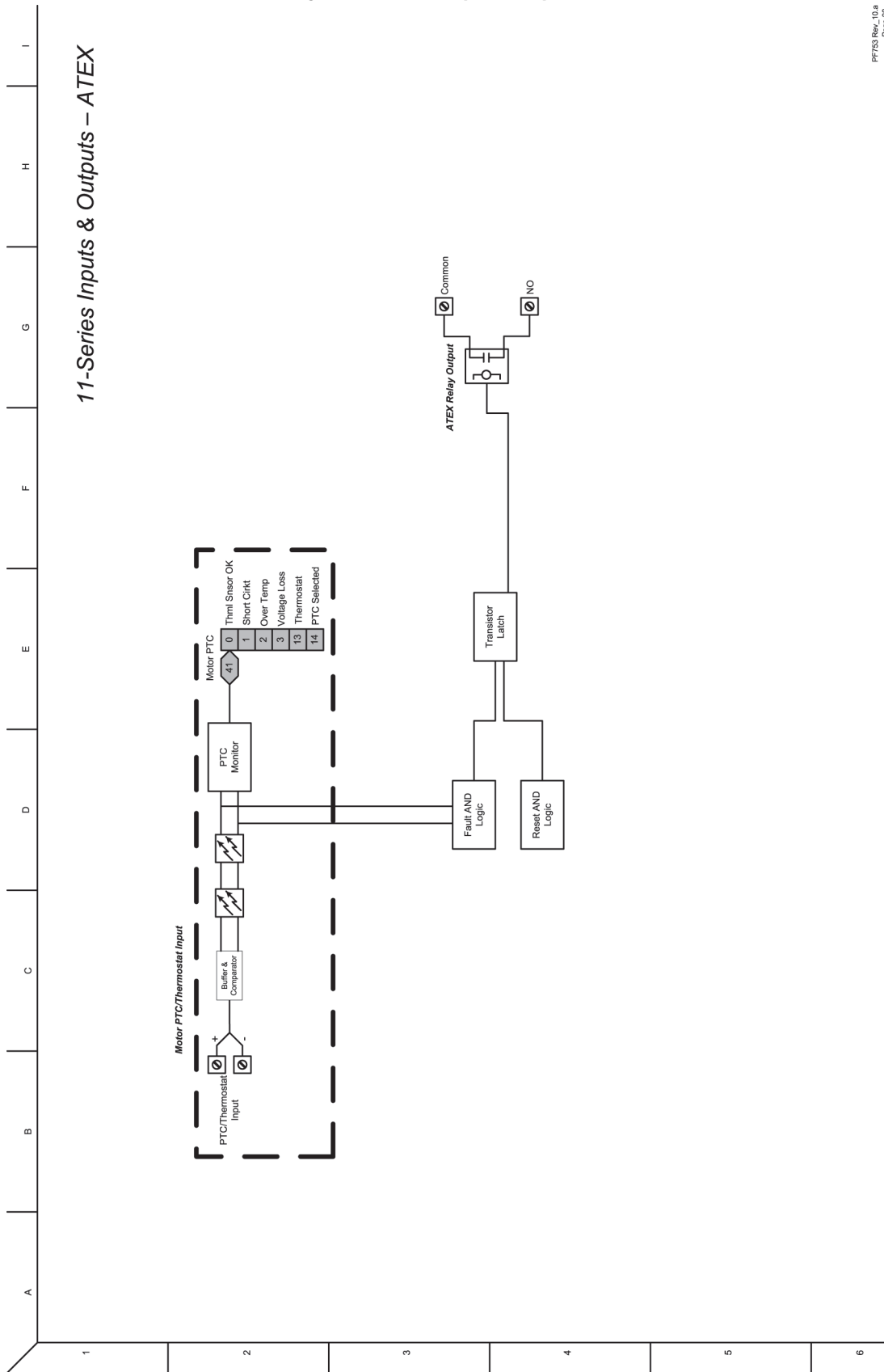
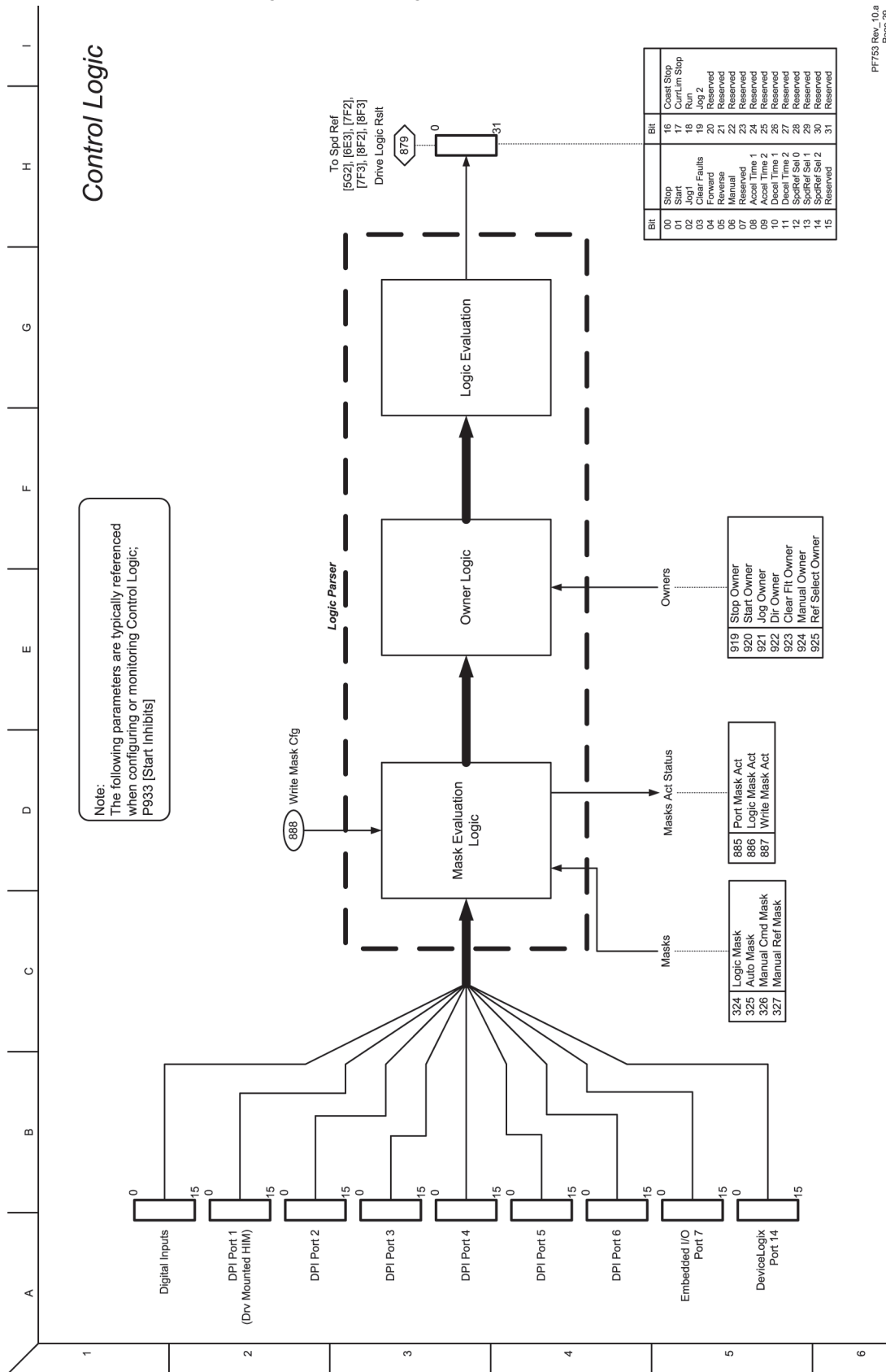
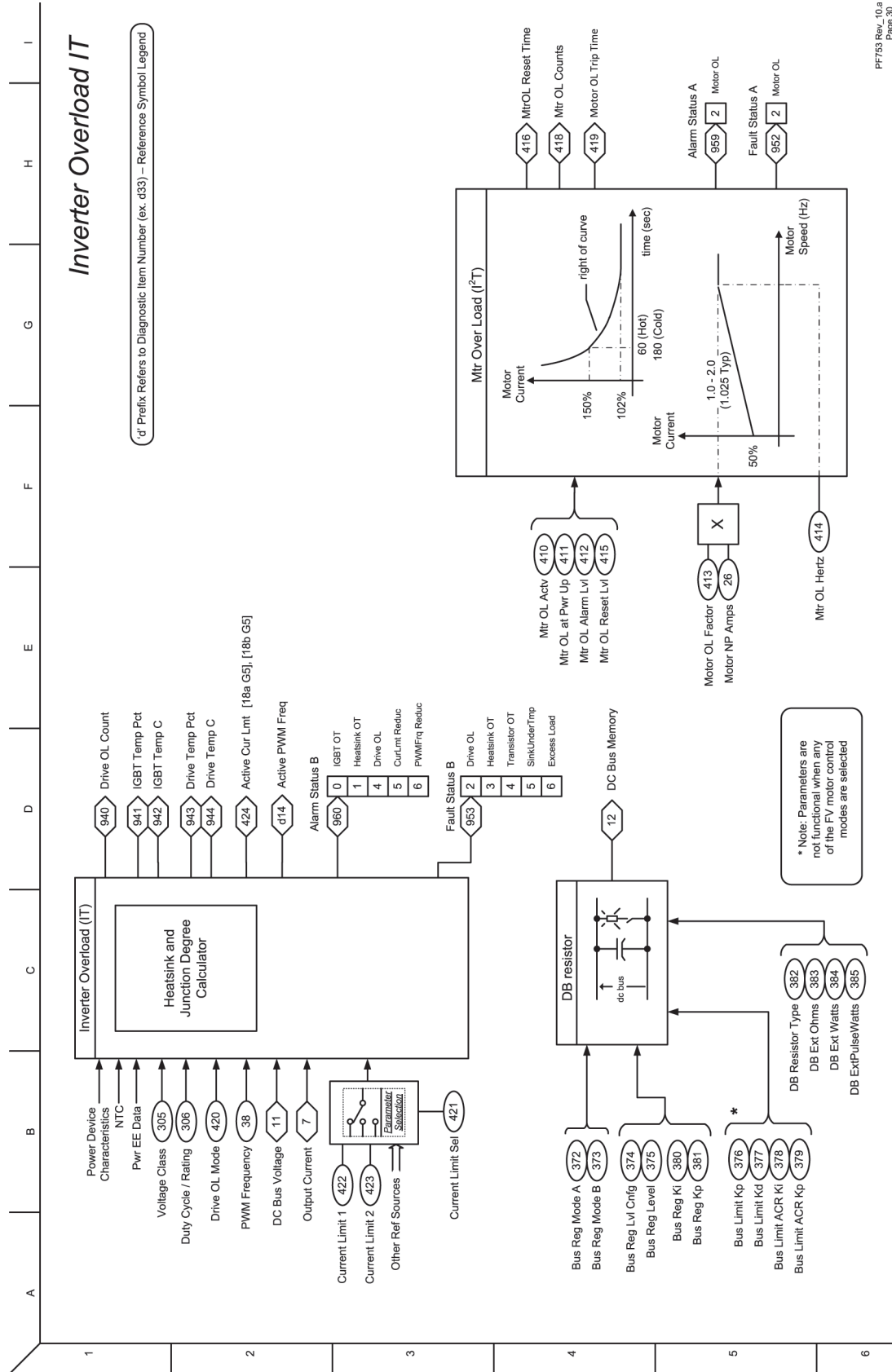


Figure 35 - Control Logic



PF753 Rev\_10.a  
Page 28

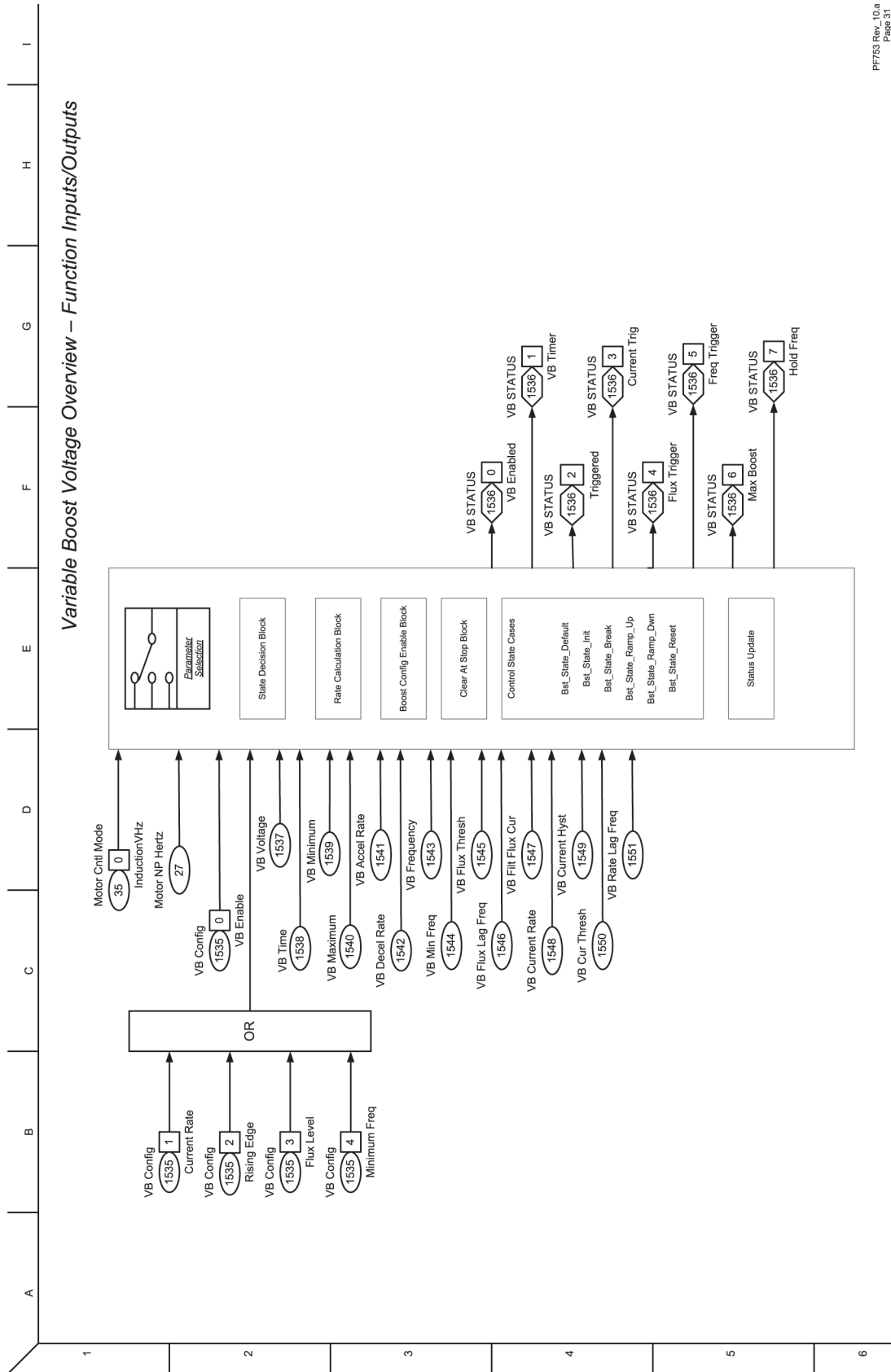
Figure 36 - Inverter Overload IT



PF753 Rev\_10.a  
Page 36



**Figure 37 - Variable Boost Voltage Overview**



PF753 Rev\_10.a  
Page 31

**Notes:**

## PowerFlex 755 Control Block Diagrams

The block diagrams in this appendix are applicable to firmware revision 11.002 and earlier only.

Flow diagrams on the following pages illustrate the PowerFlex® 755 drive control algorithms.

<b>Diagram</b>	<b>Page</b>
Flux Vector Overview	413
VF, SV Overview	414
Speed/Position Feedback	415
Speed Control - Reference Overview	416
Speed Control - Reference (1)	417
Speed Control - Reference (2)	418
Speed Control - Reference (3)	419
Speed Control - Reference (4)	420
Speed Control - Reference (5)	421
Speed Control - Regulator (FV)	422
Position Control - Reference	423
Position Control - Regulator	424
Position Control - Aux Functions	425
Position Control - Phase Locked Loop	426
Position Control - Position CAM	427
Position Control - Profiler/Indexer (1)	428
Position Control - Profiler/Indexer (2), Homing	429
Position Control / Auxiliary Functions - Roll Position Indicator	430
Position Control - Spindle Orientation	431
Position Control / Auxiliary Functions - Position Oriented Torque Boost	432
Torque Control - Overview (IM & SPM)	433
Torque Control - Overview (IPM)	434
Torque Control - Reference Scale & Trim	435
Torque Control - Torque	436
Torque Control - Current (IM & SPM)	437
Torque Control - Current (IPM)	438
Torque Control - Inertia Adaption	439
Torque Control - Load Observer / Estimator	440
Process Control (1)	441
Process Control (2)	442
MOP Control	443
22-Series Inputs & Outputs - Digital	444
22-Series Inputs & Outputs - Analog	445
11-Series Inputs & Outputs - Digital	446
11-Series Inputs & Outputs - Analog	447

Diagram	Page
11-Series Inputs & Outputs - ATEX	448
Control Logic	449
Inverter Overload IT	450
Friction Compensation	451
Variable Boost Voltage Overview - Function Inputs/Outputs	452
Diagnostic Tools	453
High-Speed Trend Wizard	454

## Diagram Conventions and Definitions

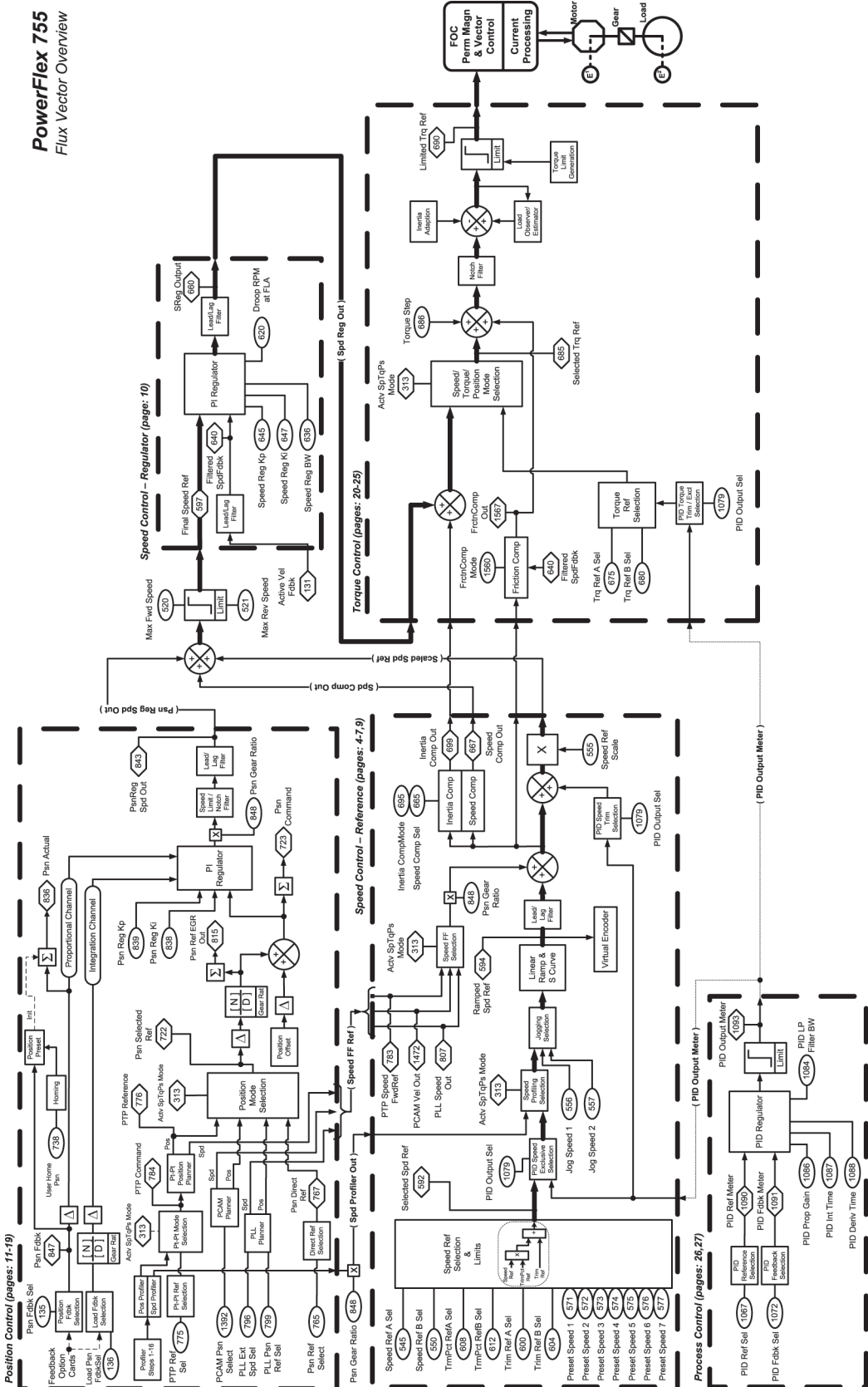
*Definitions of the Per Unit system:*  
 1.0 PU Position = Distance traveled / 1sec at Base Spd  
 1.0 PU Speed = Base Speed of the Motor  
 1.0 PU Torque = Base Torque of the Motor

**Symbol Legend:**

Drive Parameters	Option Module Parameters	→ Requires port number.
		Read Only Parameter
		Read / Write Parameter
		Read Only Parameter with Bit Enumeration
		Read / Write Parameter with Bit Enumeration
		Provides additional information
( )		= Enumerated Parameter
[ ]		= Page and Coordinate ex. 3A2 = pg 3, Column A, Row 2
		= Constant value
'd'		= Prefix refers to Diagnostic Item Number ex. d33 = Diagnostic Item 33

**\* Notes, Important :**  
 (1) These diagrams are for reference only and may not accurately reflect all logical control signals; actual functionality is implied by the approximated diagrams. Accuracy of these diagrams is not guaranteed.

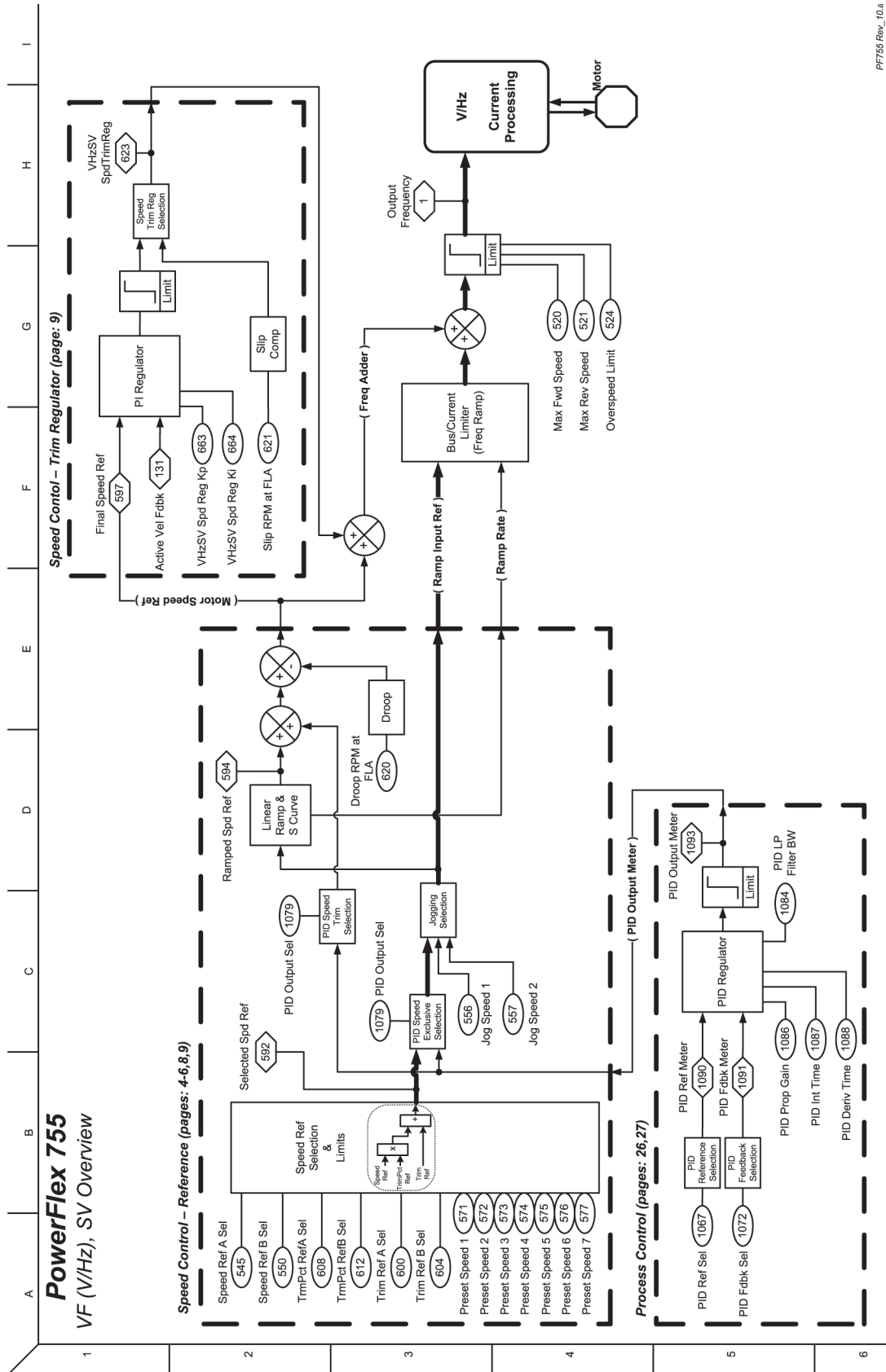
Figure 38 - Flux Vector Overview



PowerFlex 755 Flux Vector Overview

PF755 Rev. 0.0 Page 1

Figure 39 - VF, SV Overview



PF755 Rev. 10.a  
Page 2

**Figure 40 - Speed/Position Feedback**

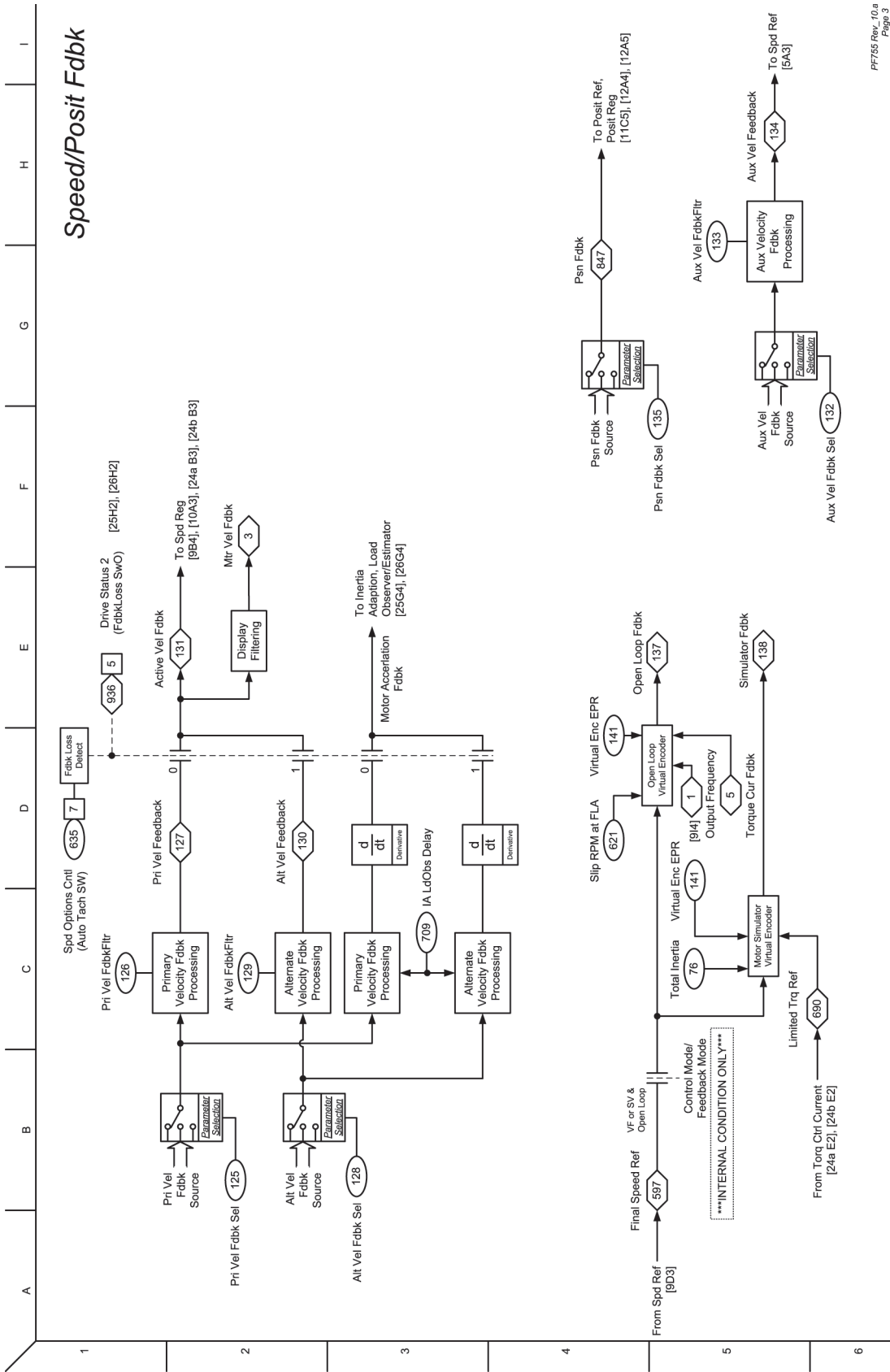
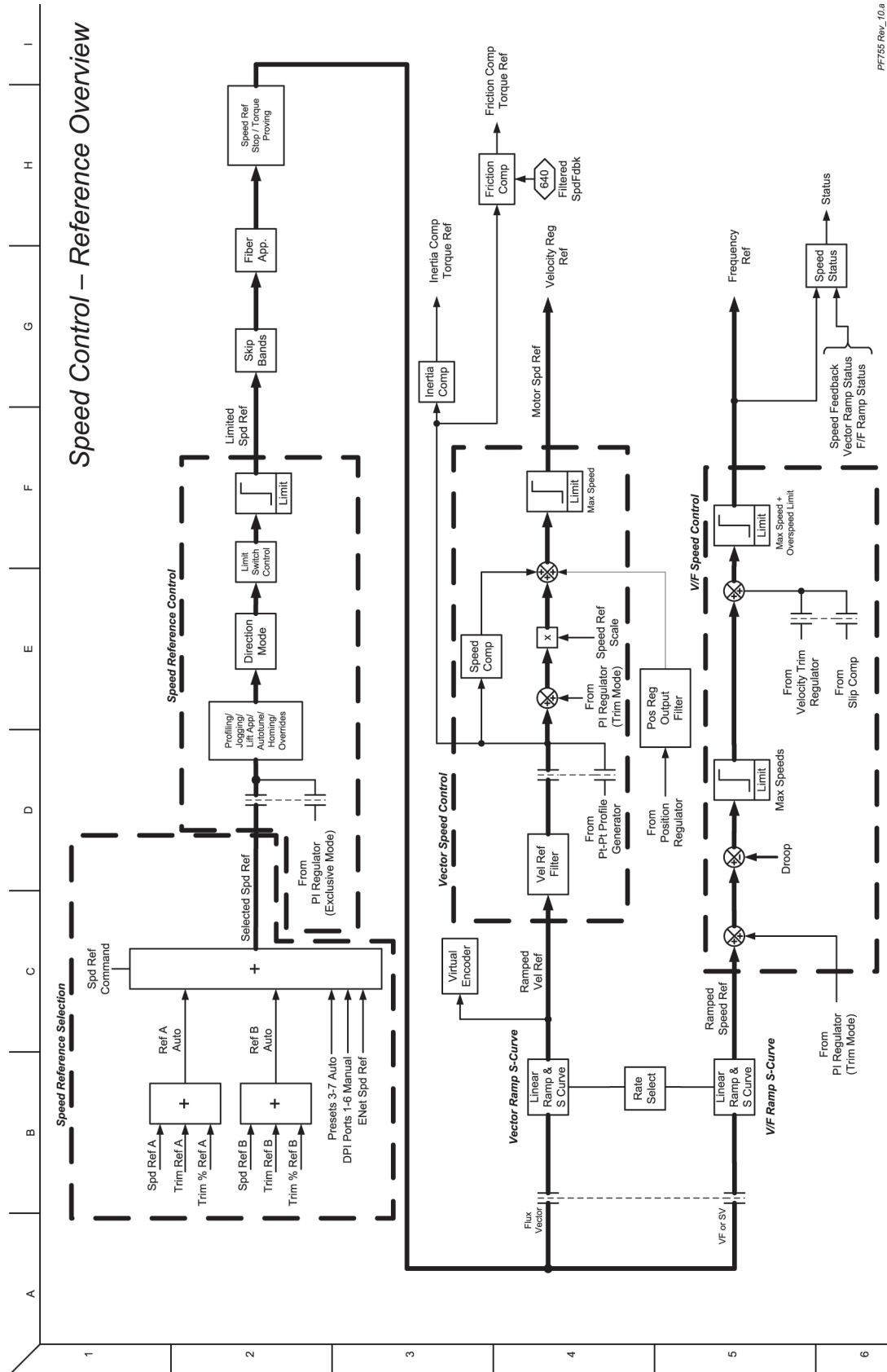


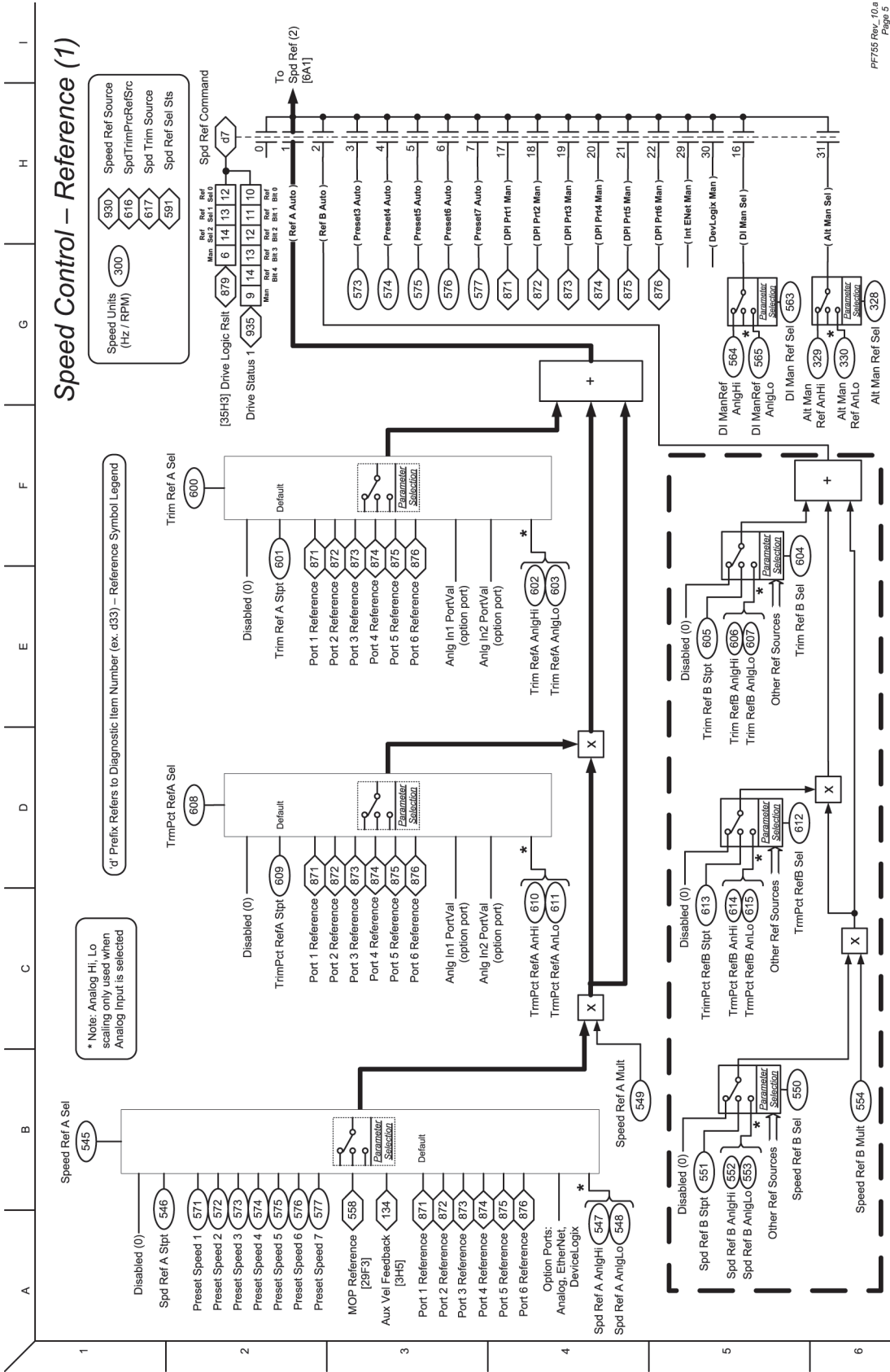
Figure 41 - Speed Control - Reference Overview



PF755\_Rev\_10.a  
Page 4

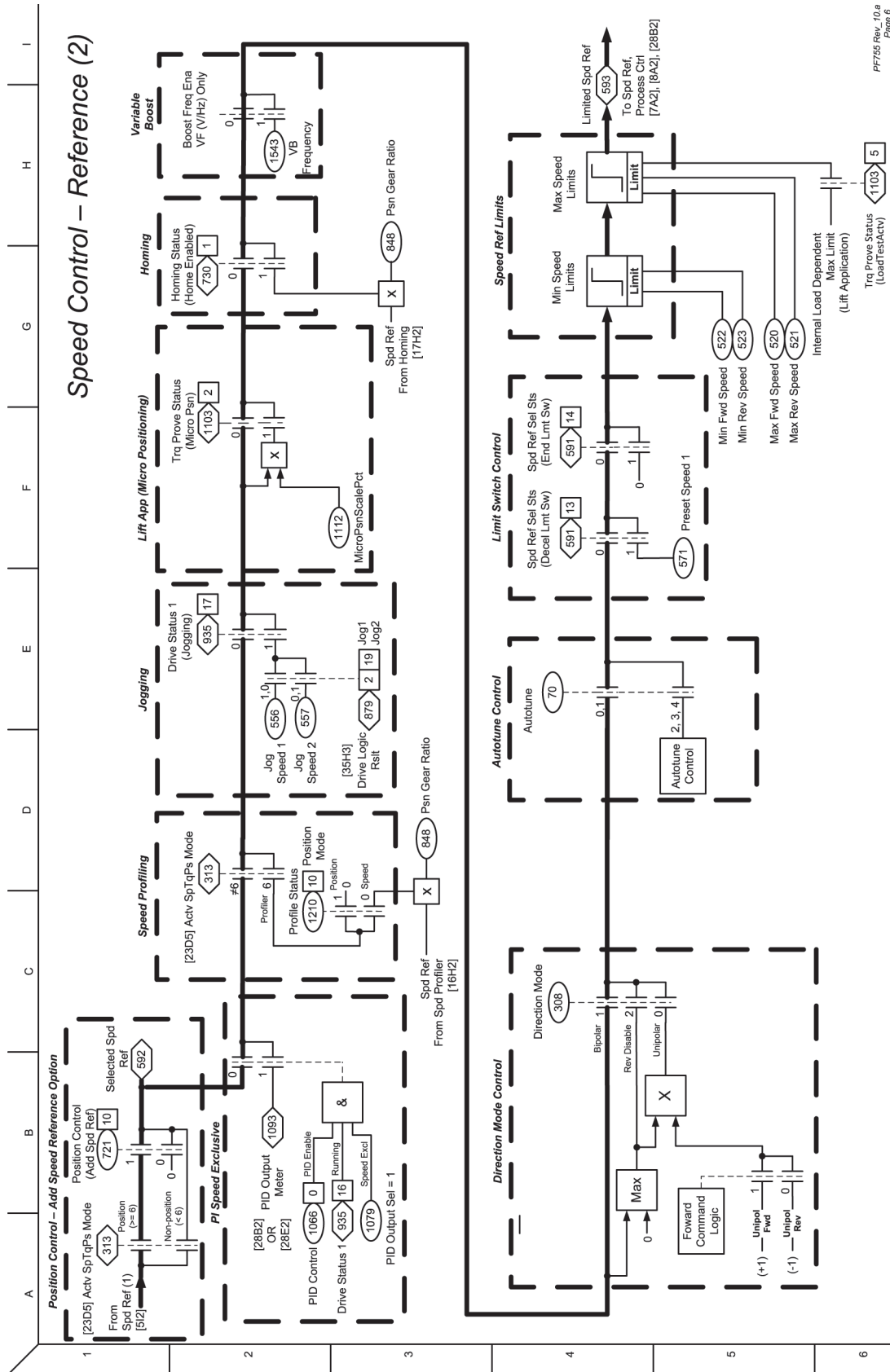


Figure 42 - Speed Control - Reference (1)



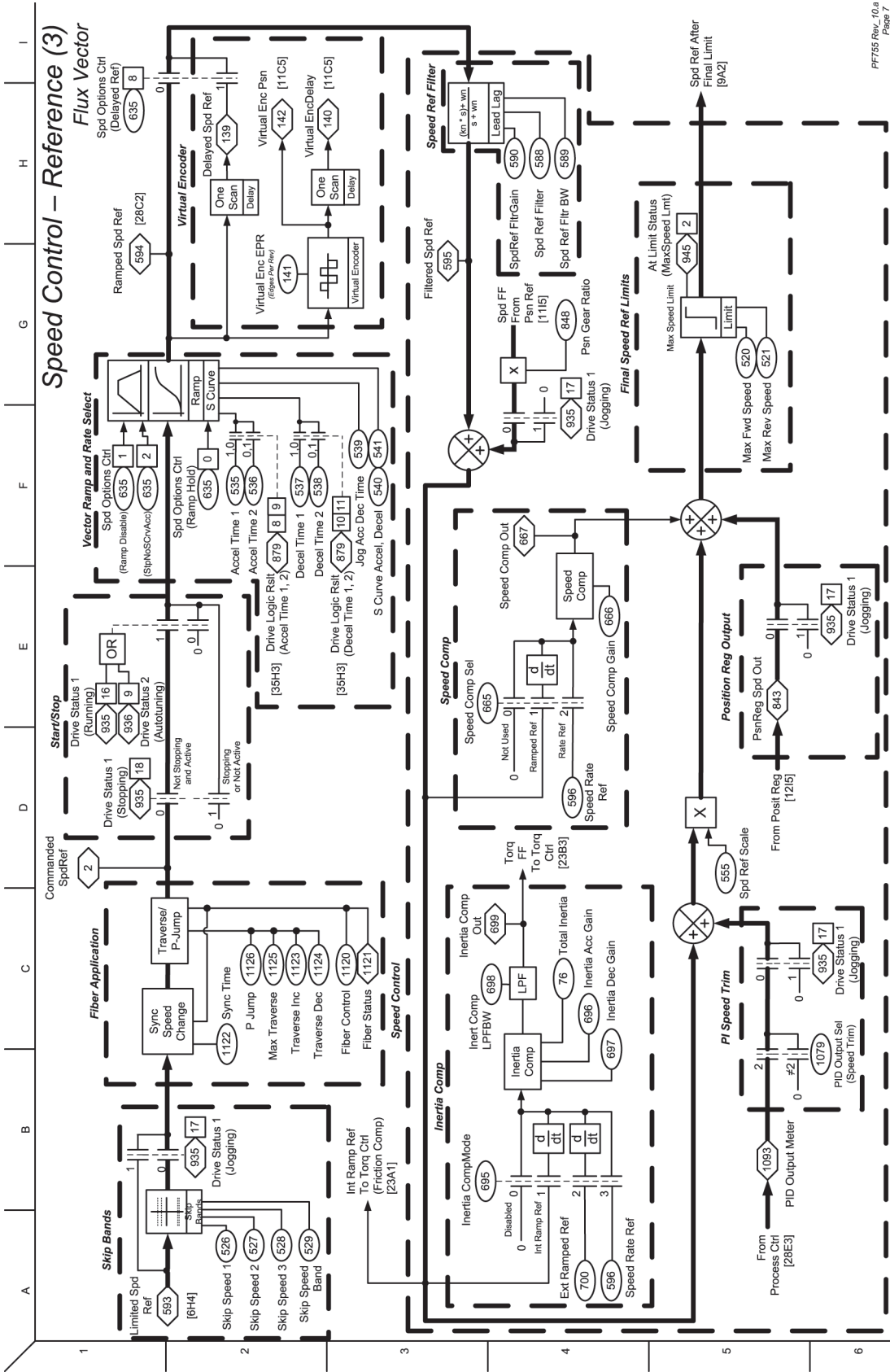
PF755 Rev. 10.8  
Page 5

Figure 43 - Speed Control - Reference (2)



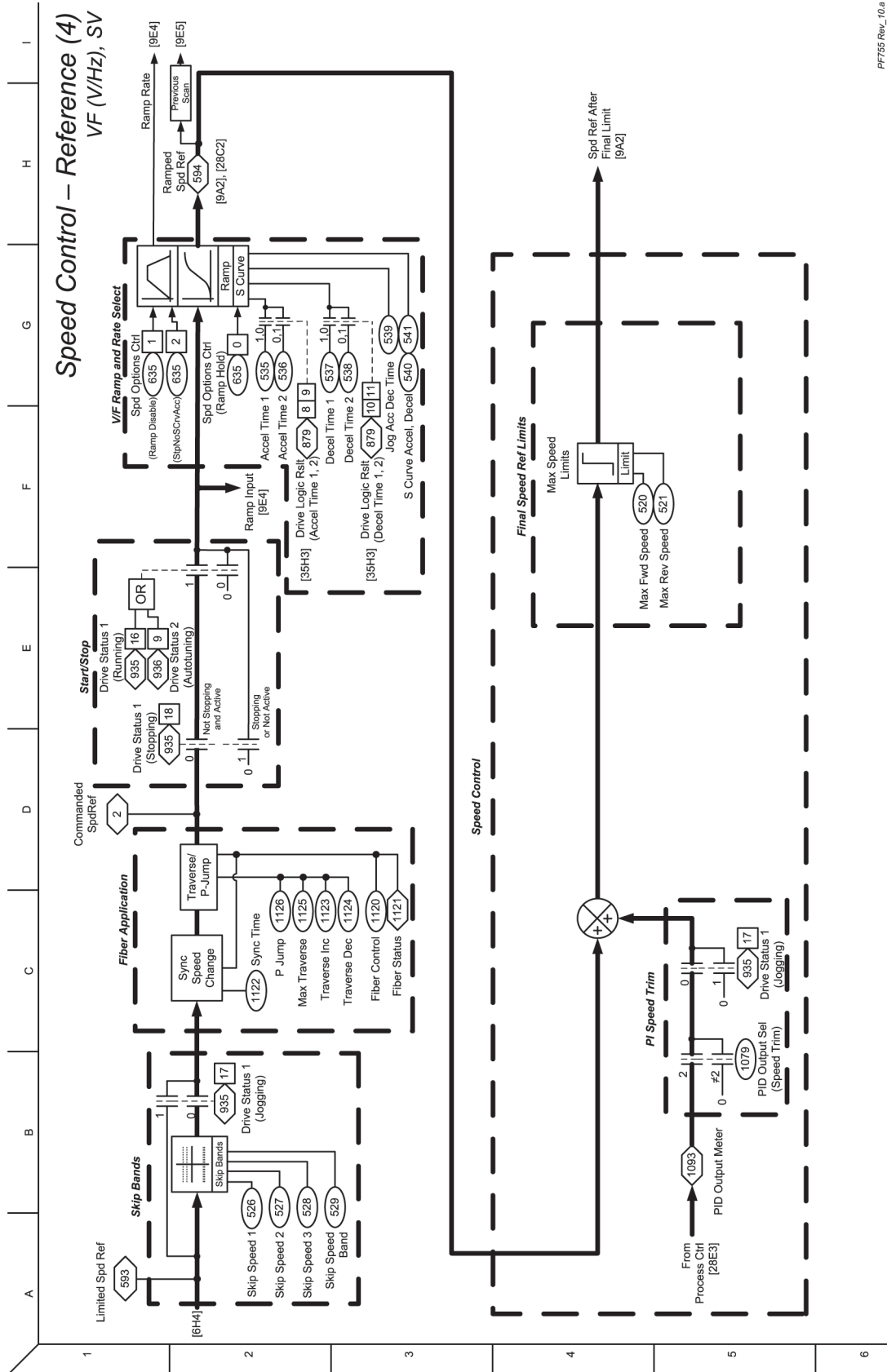
PF755 Rev. 10.0  
Page 6

Figure 44 - Speed Control - Reference (3)



PF755 Rev. 10.a  
Page 7

Figure 45 - Speed Control - Reference (4)





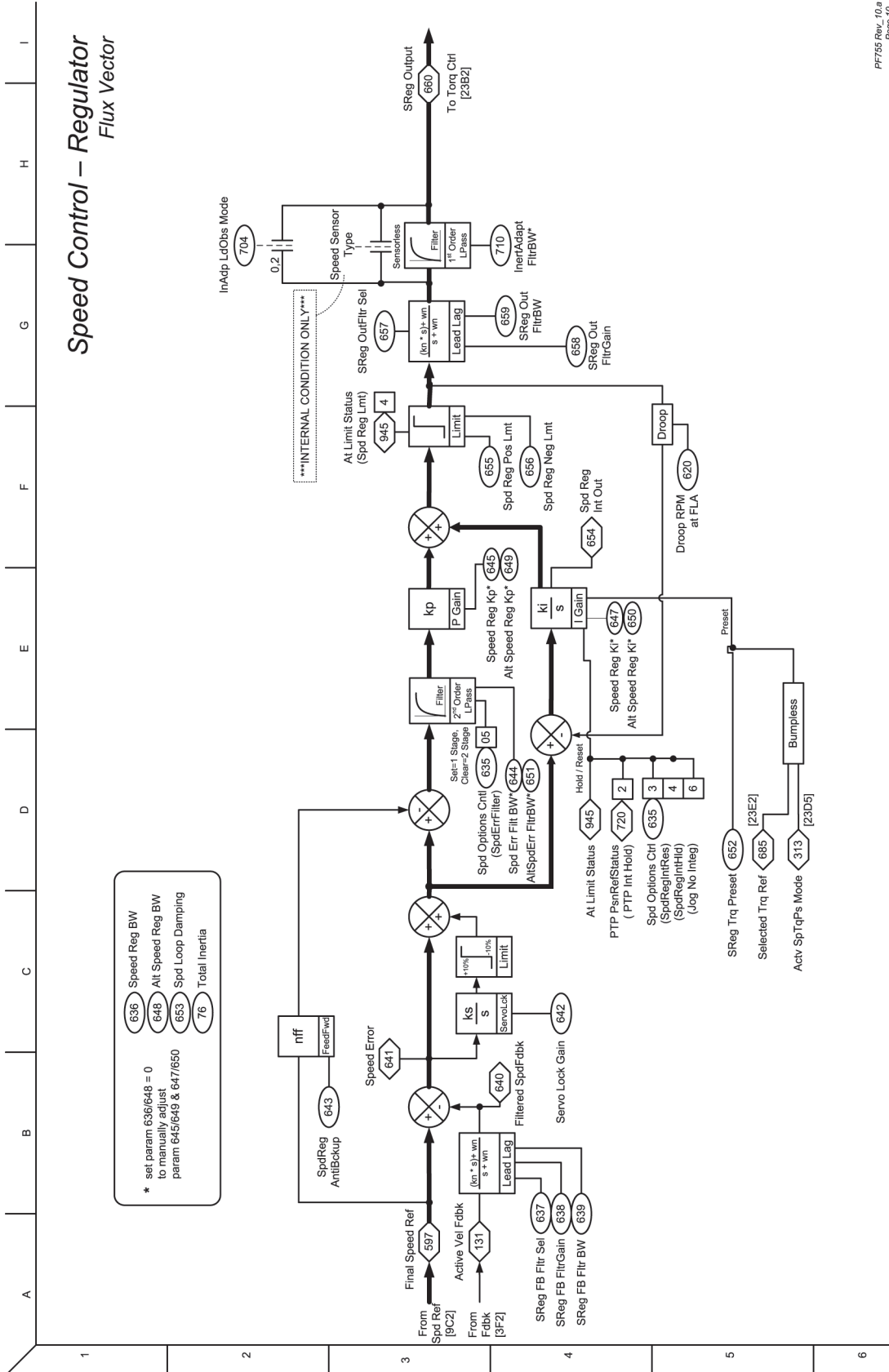
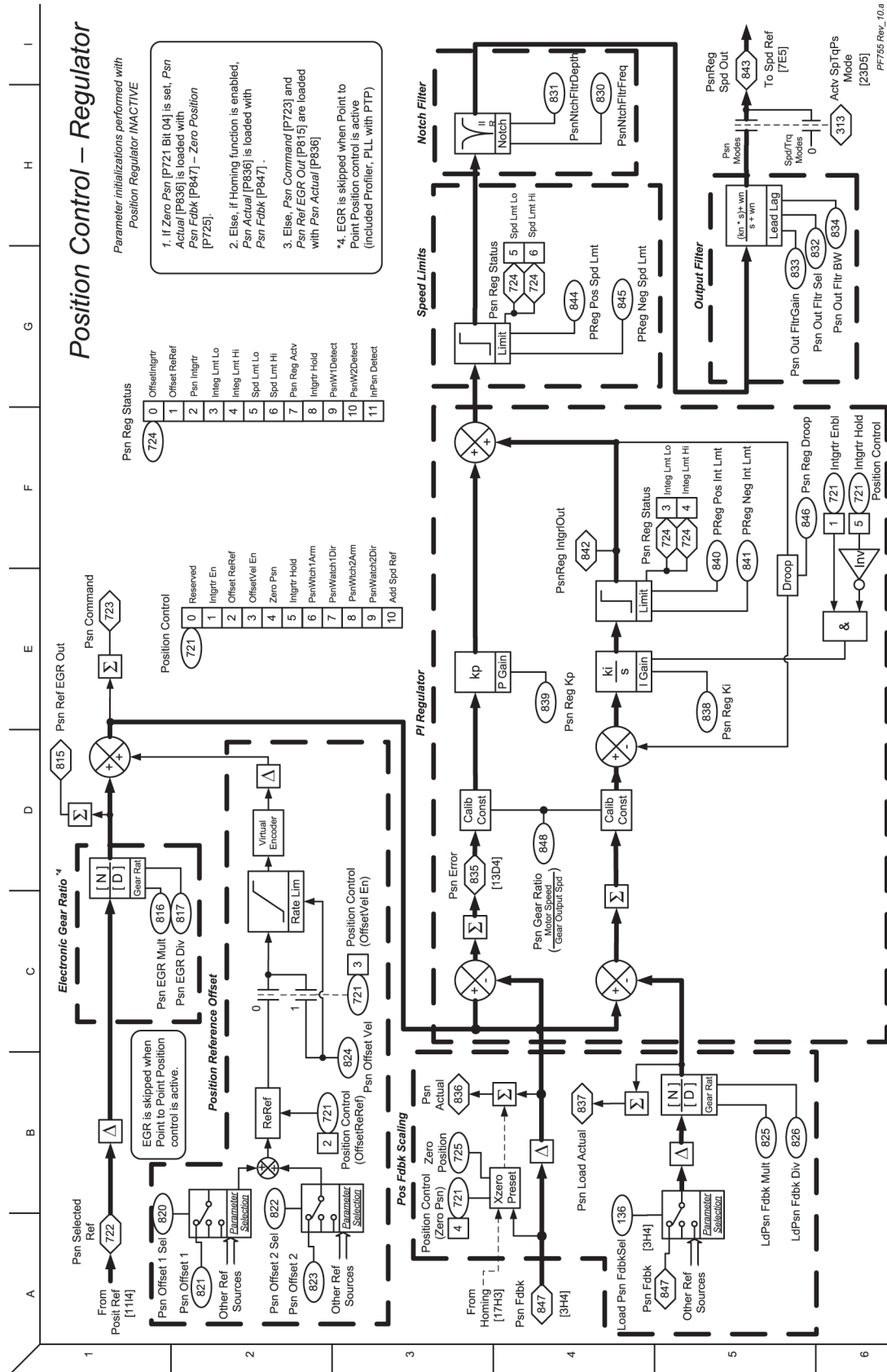


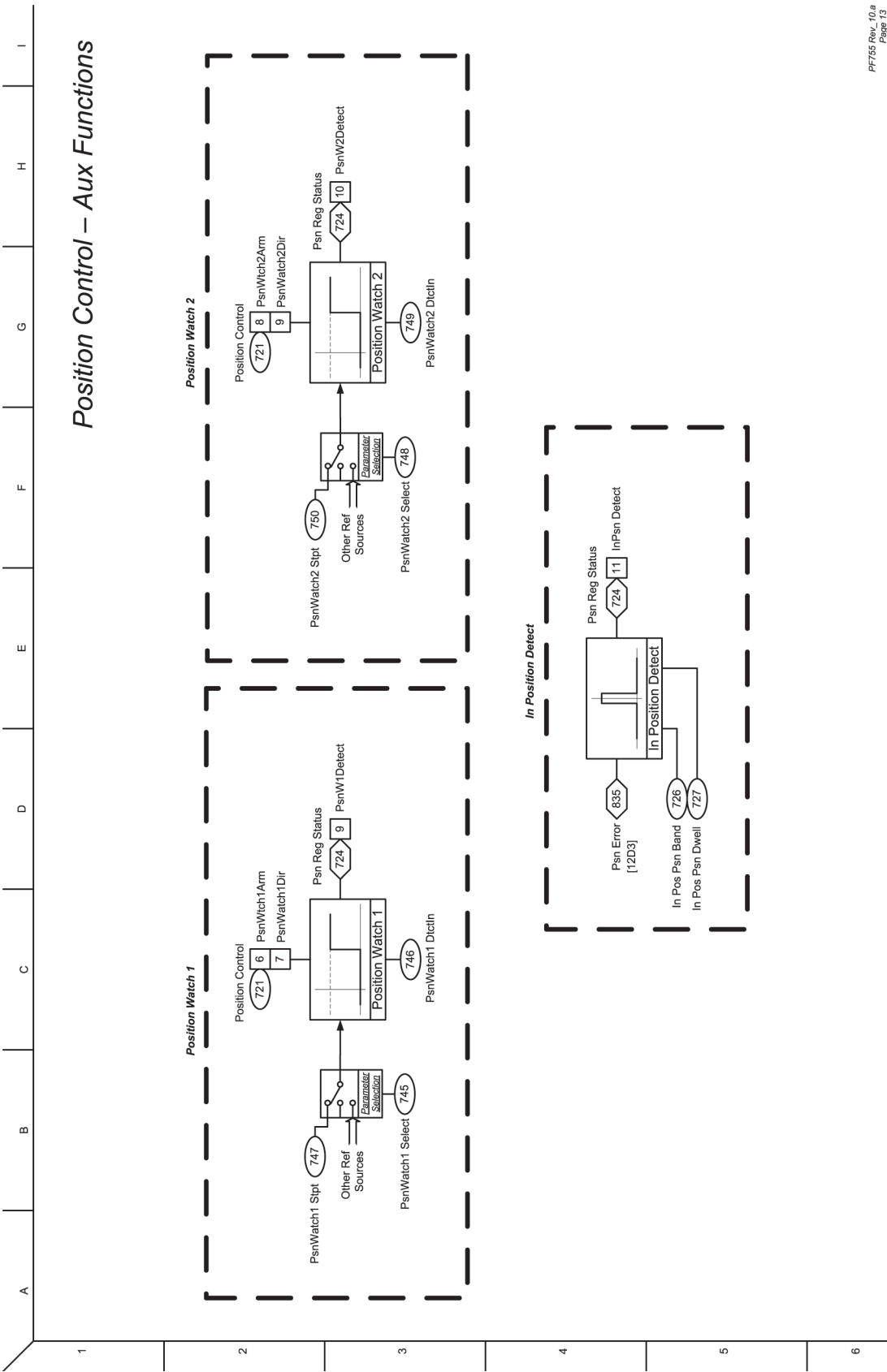


Figure 49 - Position Control - Regulator



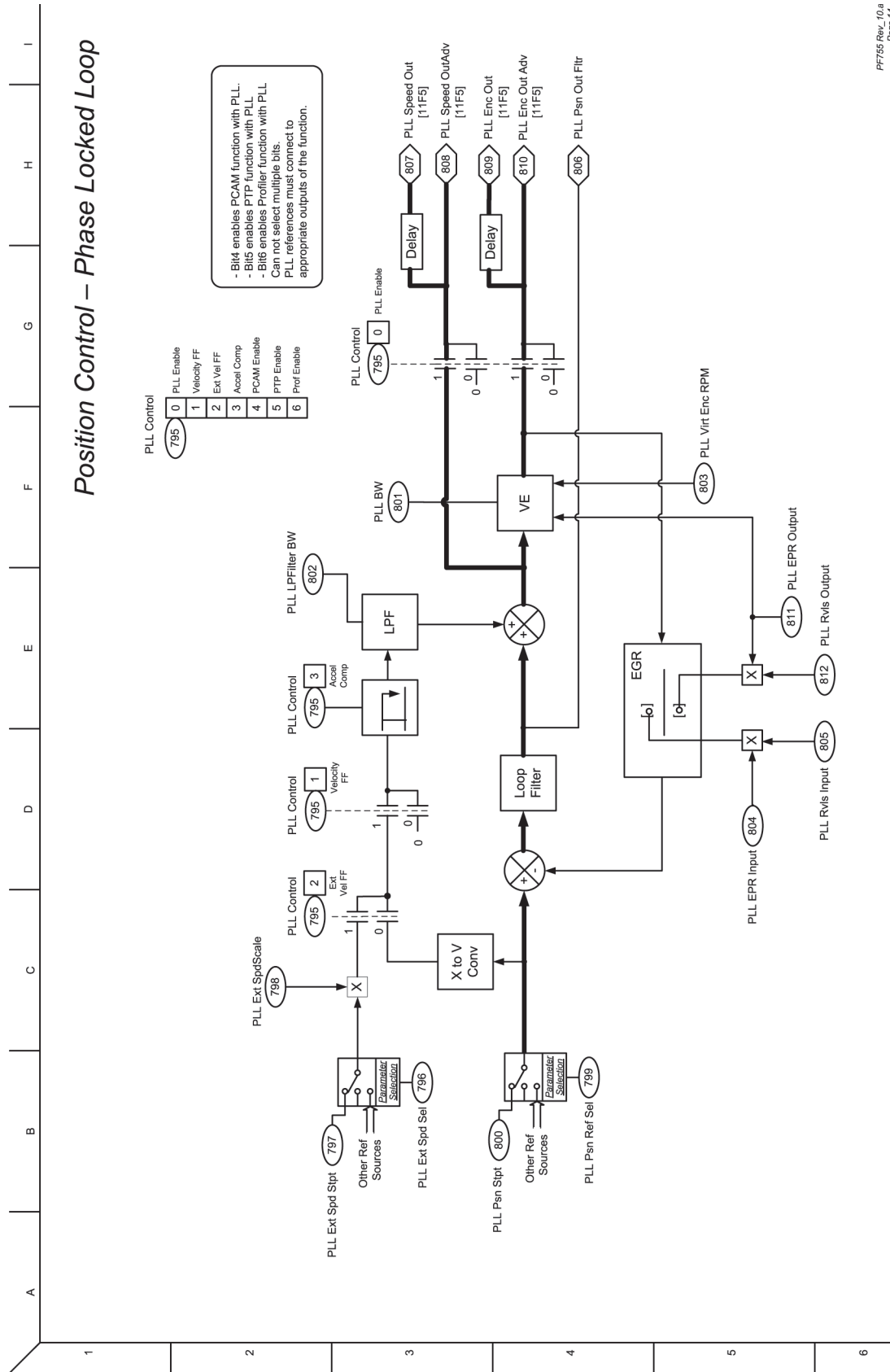


**Figure 50 - Position Control - Aux Functions**



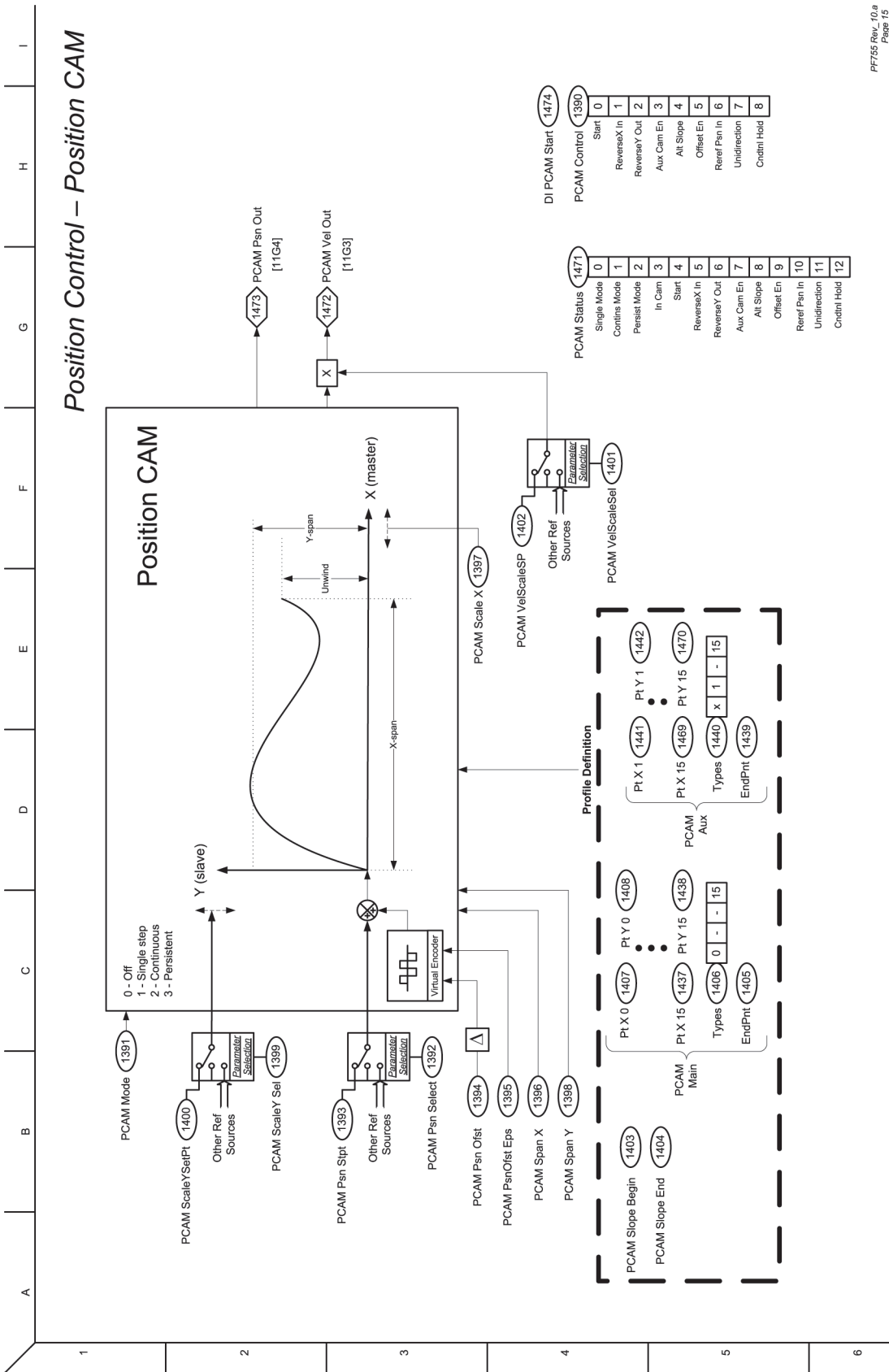
PF755 Rev. 10.a  
Page 13

Figure 51 - Position Control - Phase Locked Loop



PF755 Rev\_10.a  
Page 14

**Figure 52 - Position Control - Position CAM**



PF7755 Rev. 10.0  
Page 15

Figure 53 - Position Control - Profiler/Indexer (1)

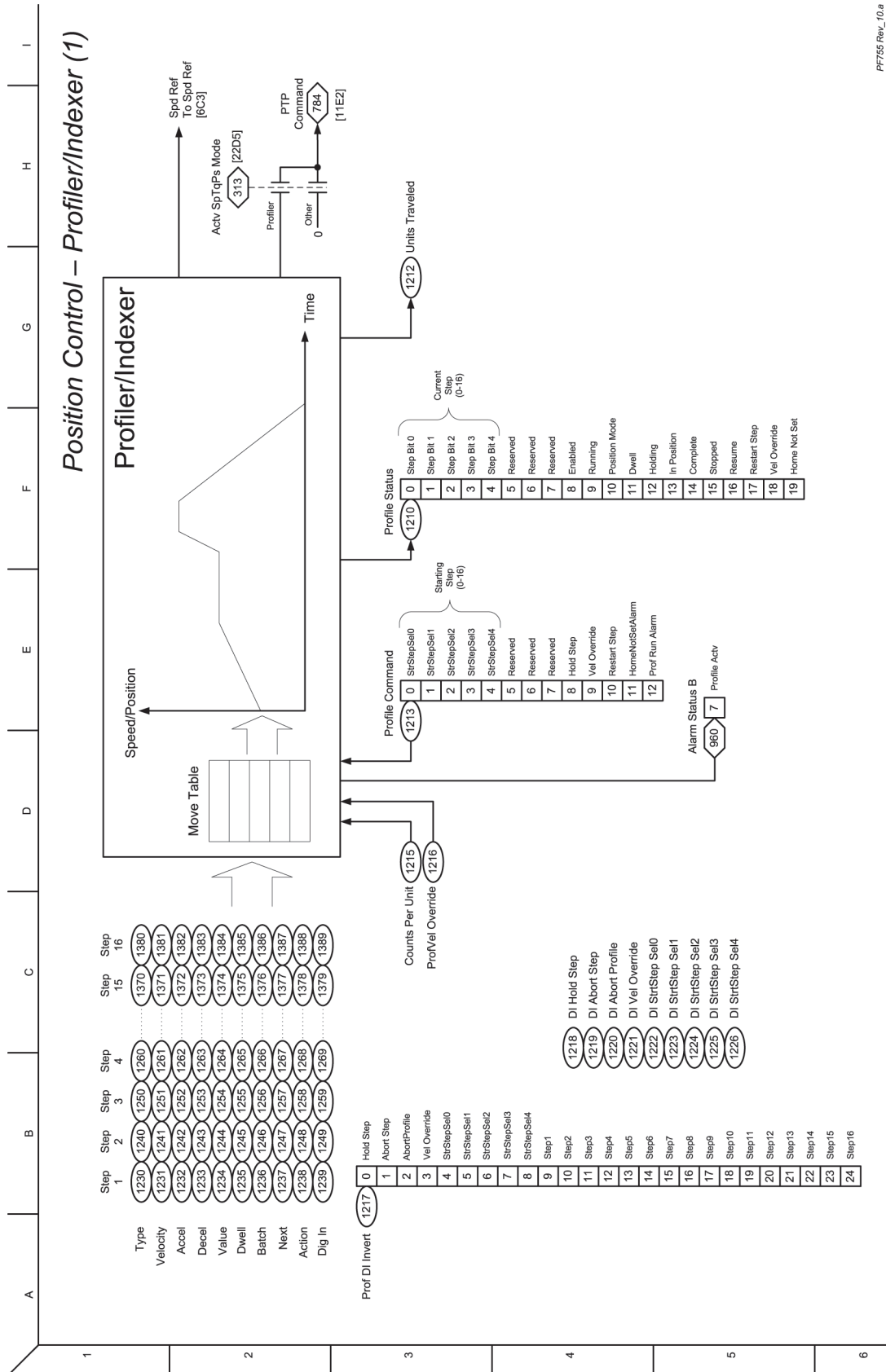
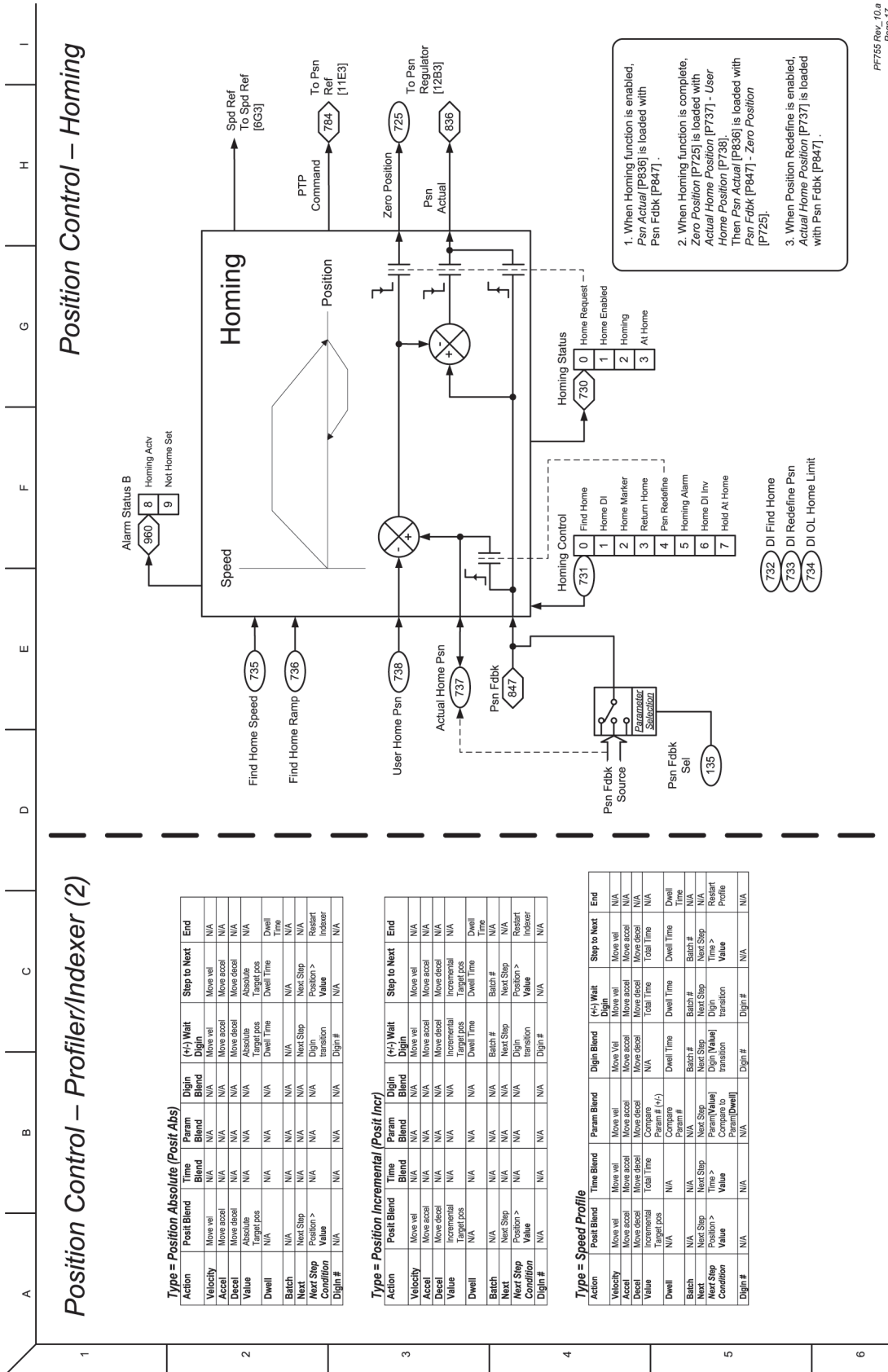


Figure 54 - Position Control - Profiler/Indexer (2), Homing



Position Control – Homing

Position Control – Profiler/Indexer (2)

**Type = Position Absolute (Posit Abs)**

Action	Posit Blend	Time Blend	Param Blend	Digin Blend	(+/-) Wait Digin	Step to Next	End
Velocity	Move vel	N/A	N/A	N/A	Move vel	Move vel	N/A
Accel	Move accel	N/A	N/A	N/A	Move accel	Move accel	N/A
Decel	Move decel	N/A	N/A	N/A	Move decel	Move decel	N/A
Value	Absolute	N/A	N/A	N/A	Absolute	Absolute	N/A
	Target pos	N/A	N/A	N/A	Target pos	Target pos	N/A
Dwell	N/A	N/A	N/A	N/A	Dwell time	Dwell time	N/A
Batch	N/A	N/A	N/A	N/A	N/A	N/A	N/A
Next	Next Step	N/A	N/A	N/A	Next Step	Next Step	N/A
Next Step Condition	Position > Value	N/A	N/A	N/A	Digin transition	Position > Value	Restart Indexer
Digit #	N/A	N/A	N/A	N/A	Digin #	N/A	N/A

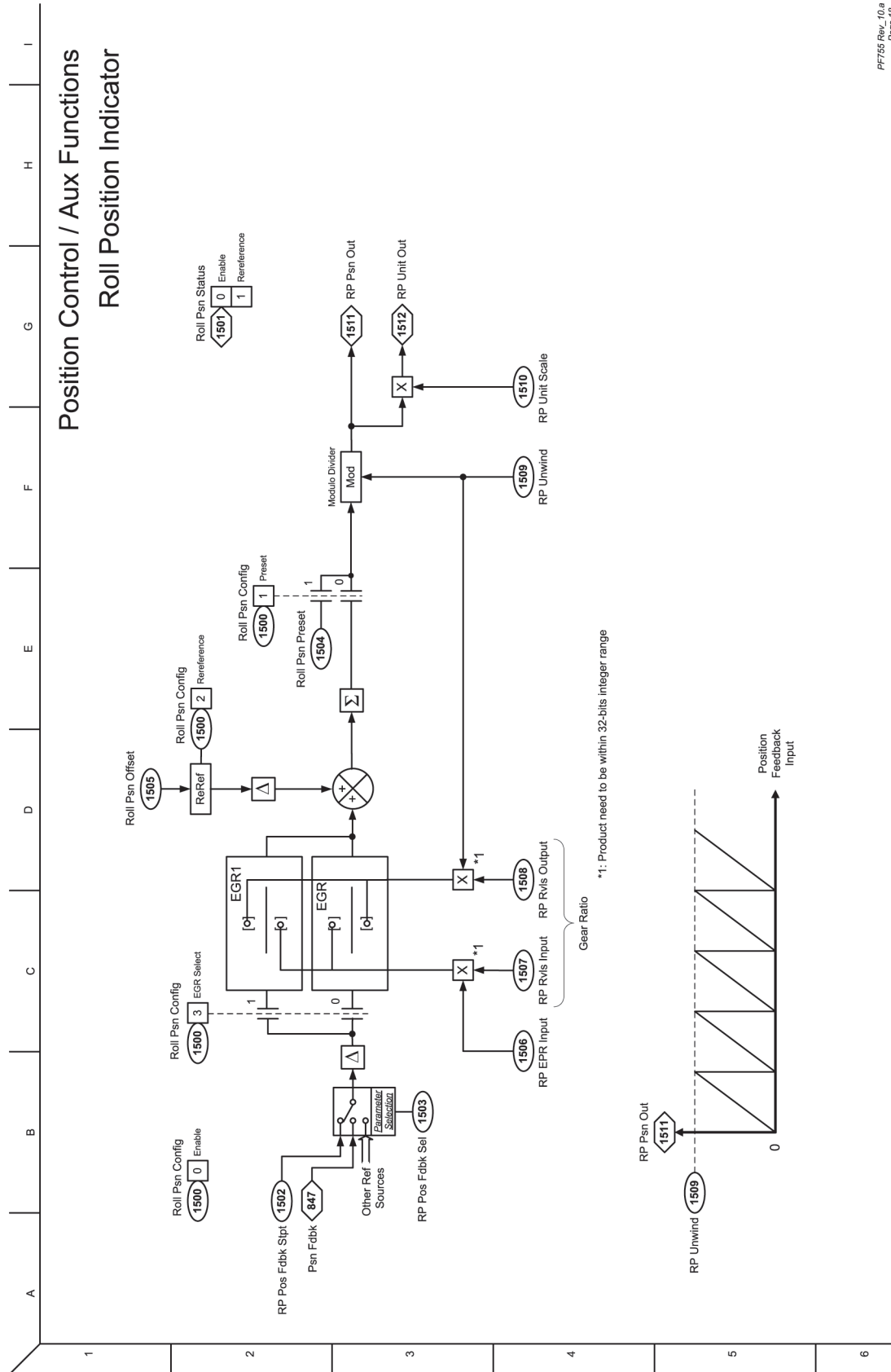
**Type = Position Incremental (Posit Incr)**

Action	Posit Blend	Time Blend	Param Blend	Digin Blend	(+/-) Wait Digin	Step to Next	End
Velocity	Move vel	N/A	N/A	N/A	Move vel	Move vel	N/A
Accel	Move accel	N/A	N/A	N/A	Move accel	Move accel	N/A
Decel	Move decel	N/A	N/A	N/A	Move decel	Move decel	N/A
Value	Incremental	N/A	N/A	N/A	Target pos	Target pos	N/A
	Target pos	N/A	N/A	N/A	Target pos	Target pos	N/A
Dwell	N/A	N/A	N/A	N/A	Dwell time	Dwell time	N/A
Batch	N/A	N/A	N/A	N/A	Batch #	Batch #	N/A
Next	Next Step	N/A	N/A	N/A	Next Step	Next Step	N/A
Next Step Condition	Position > Value	N/A	N/A	N/A	Digin transition	Position > Value	Restart Indexer
Digit #	N/A	N/A	N/A	N/A	Digin #	N/A	N/A

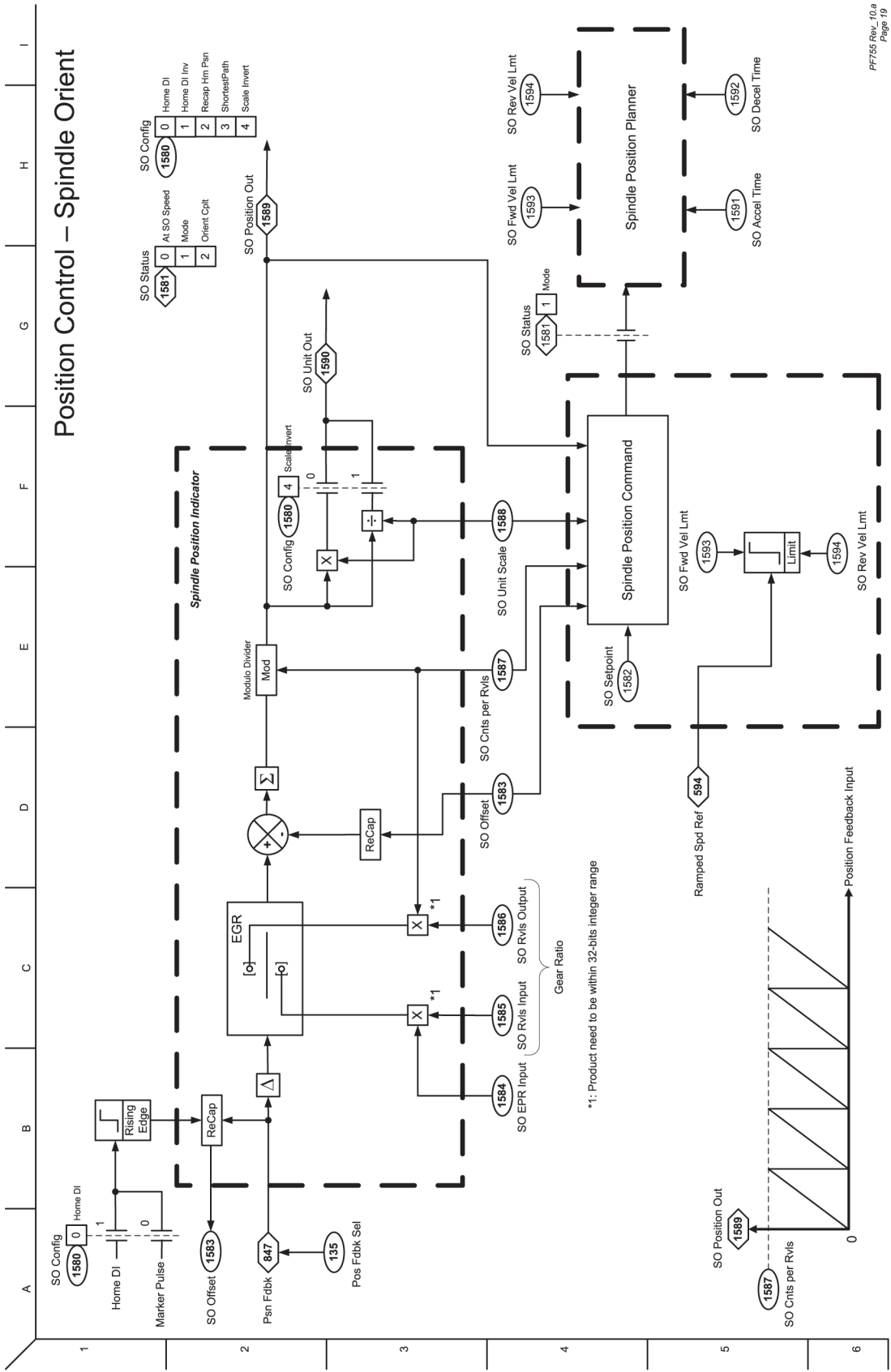
**Type = Speed Profile**

Action	Posit Blend	Time Blend	Param Blend	Digin Blend	(+/-) Wait Digin	Step to Next	End
Velocity	Move vel	Move vel	Move vel	Move vel	Move vel	Move vel	N/A
Accel	Move accel	Move accel	Move accel	Move accel	Move accel	Move accel	N/A
Decel	Move decel	Move decel	Move decel	Move decel	Move decel	Move decel	N/A
Value	Incremental	Total Time	Compare	N/A	Total Time	Total Time	N/A
	Target pos	N/A	Compare (+/-)	N/A	Total Time	Total Time	N/A
Dwell	N/A	N/A	Param #	N/A	Dwell time	Dwell time	N/A
Batch	N/A	N/A	N/A	N/A	Batch #	Batch #	N/A
Next	Next Step	Next Step	Next Step	Next Step	Next Step	Next Step	N/A
Next Step Condition	Position > Value	Time > Value	Param[Value] transition	Digin[Value] transition	Digin transition	Time > Value	Restart Profile
Digit #	N/A	N/A	N/A	N/A	Digin #	Digin #	N/A

Figure 55 - Position Control / Auxiliary Functions - Roll Position Indicator

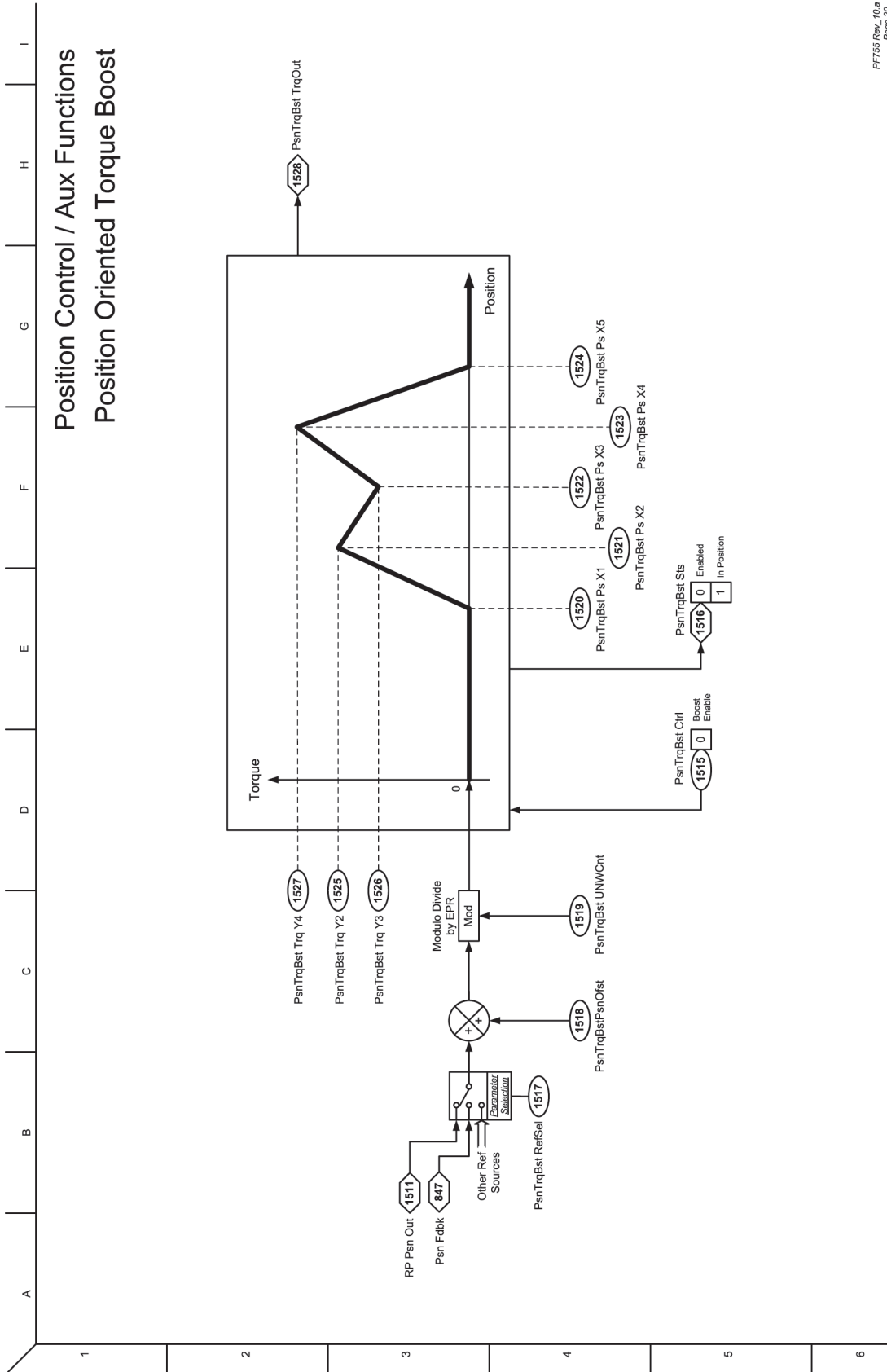


**Figure 56 - Position Control - Spindle Orient**



PF755 Rev. 10.0  
Page 19

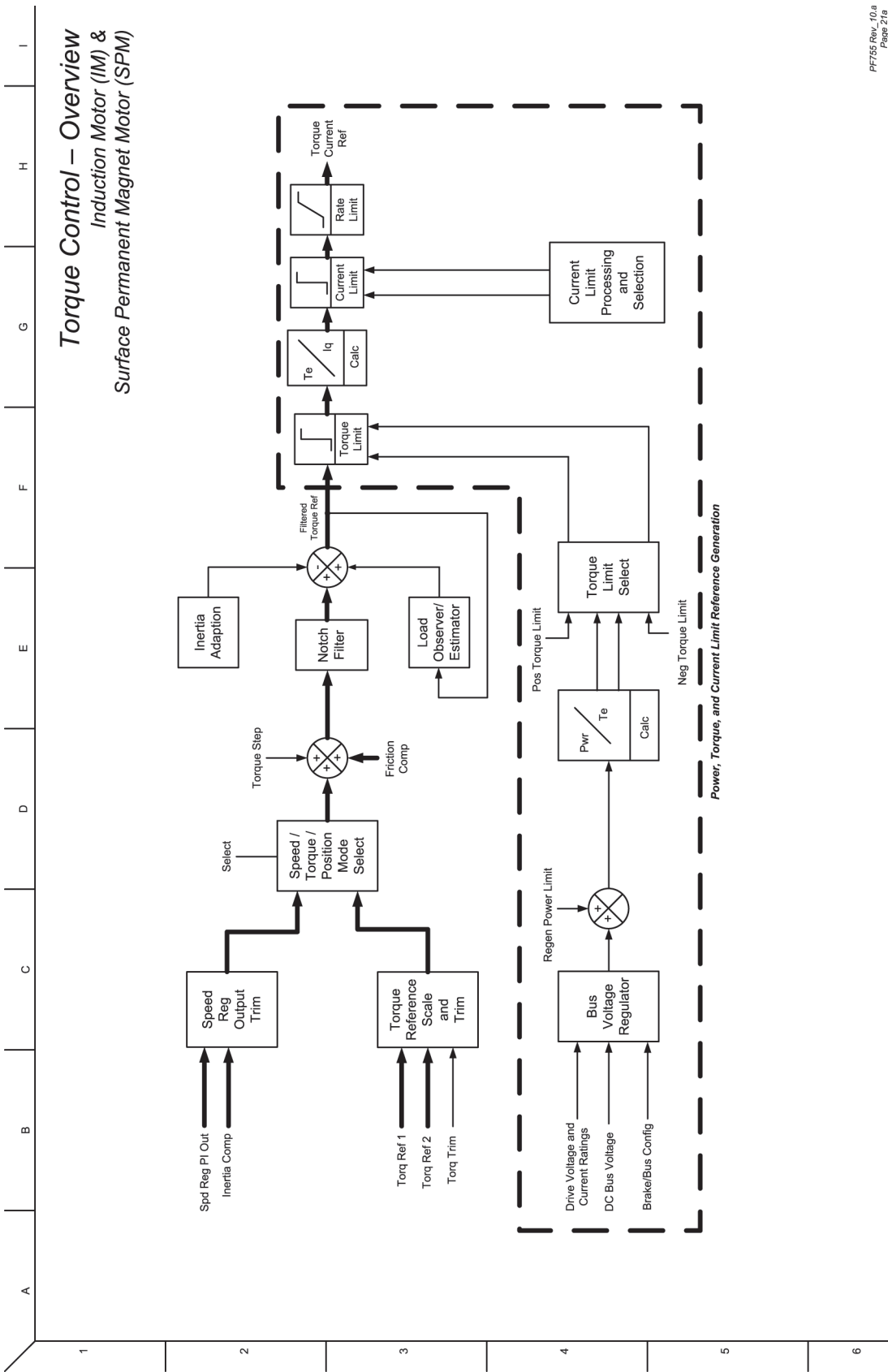
Figure 57 - Position Control / Auxiliary Functions - Position Oriented Torque Boost



PF755 Rev. 10.a  
Page 20

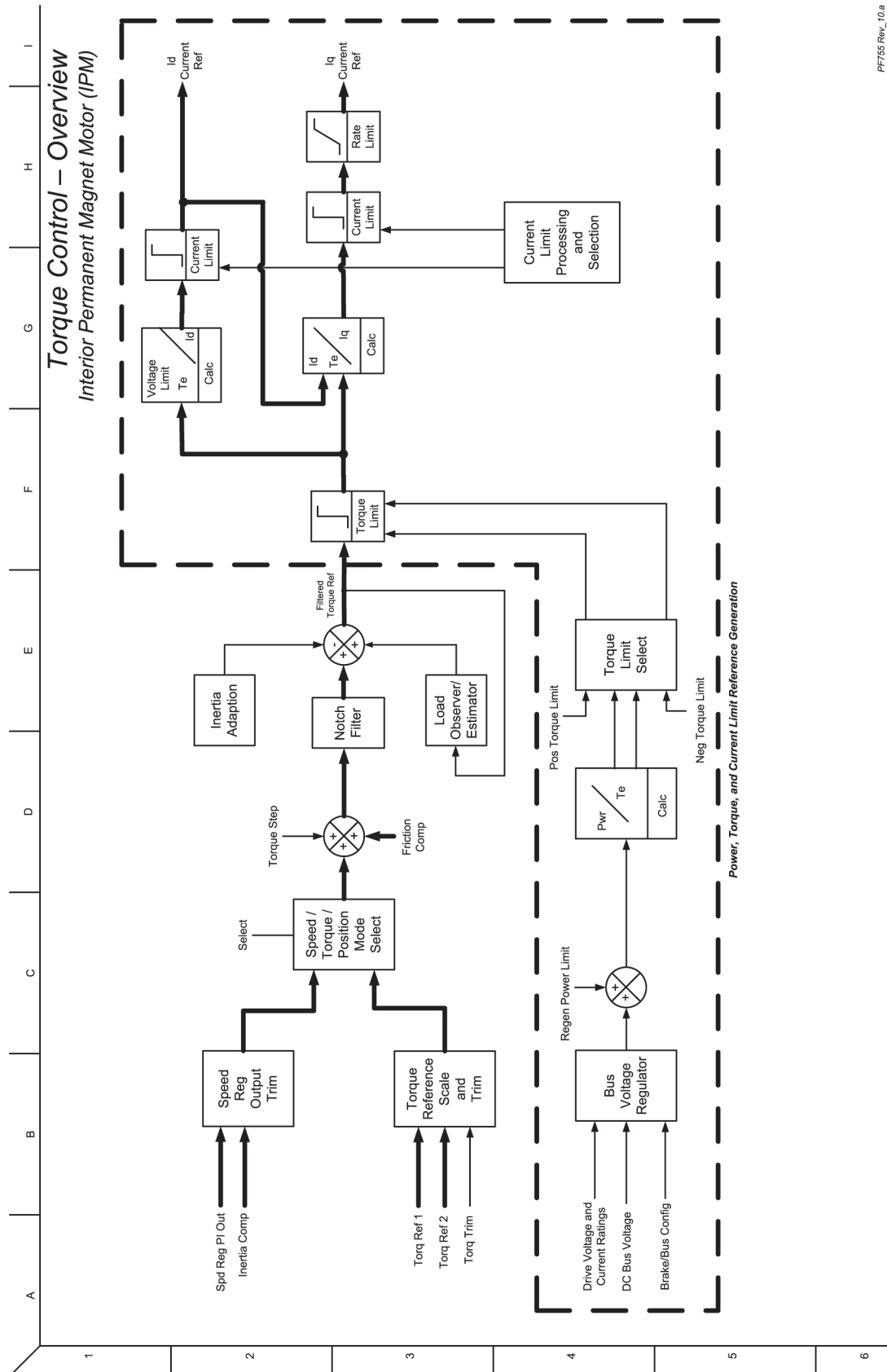


Figure 58 - Torque Control - Overview (IM & SPM)



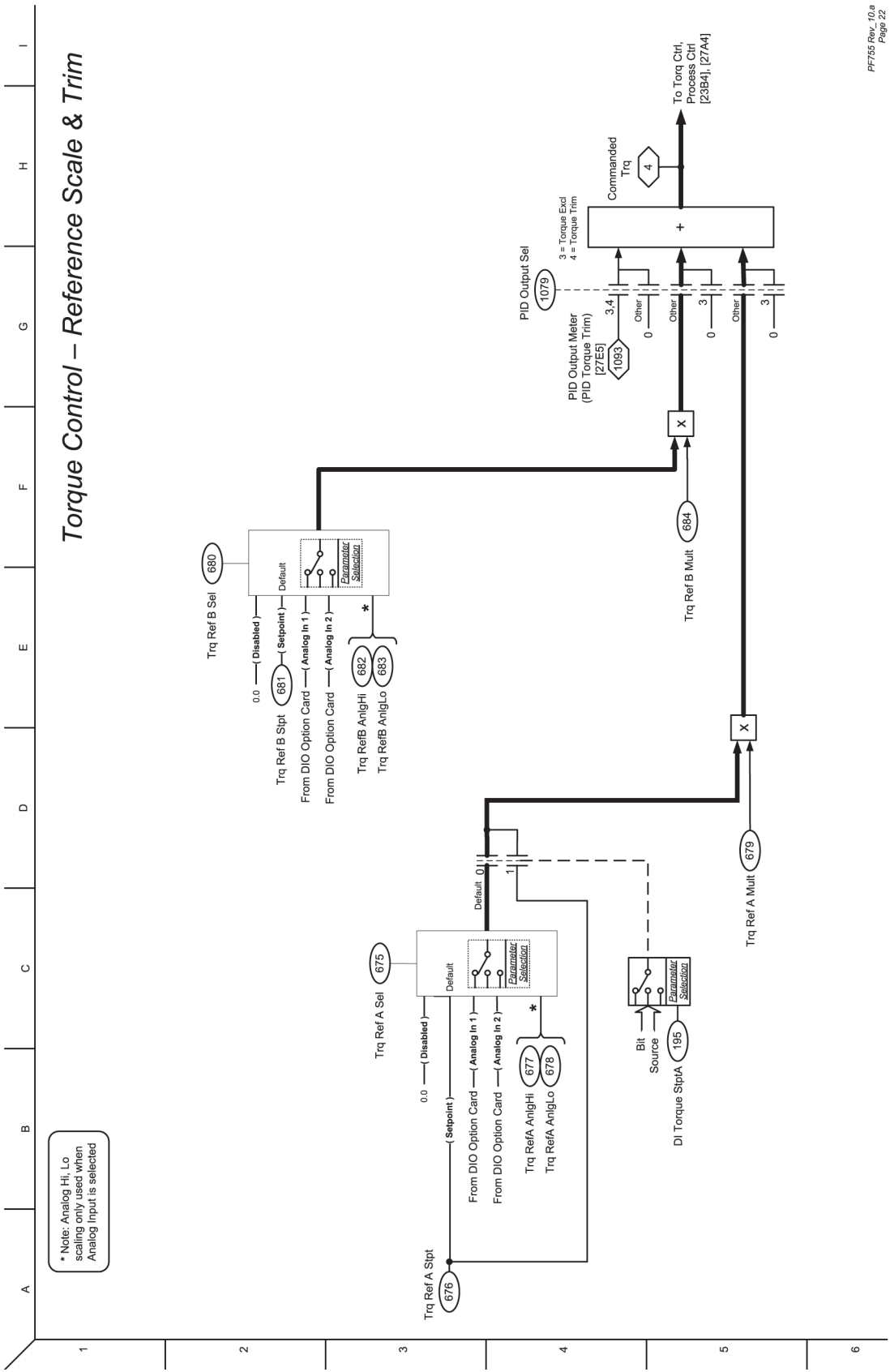
PF755 Rev. 10.a  
Page 21a

Figure 59 - Torque Control - Overview (IPM)



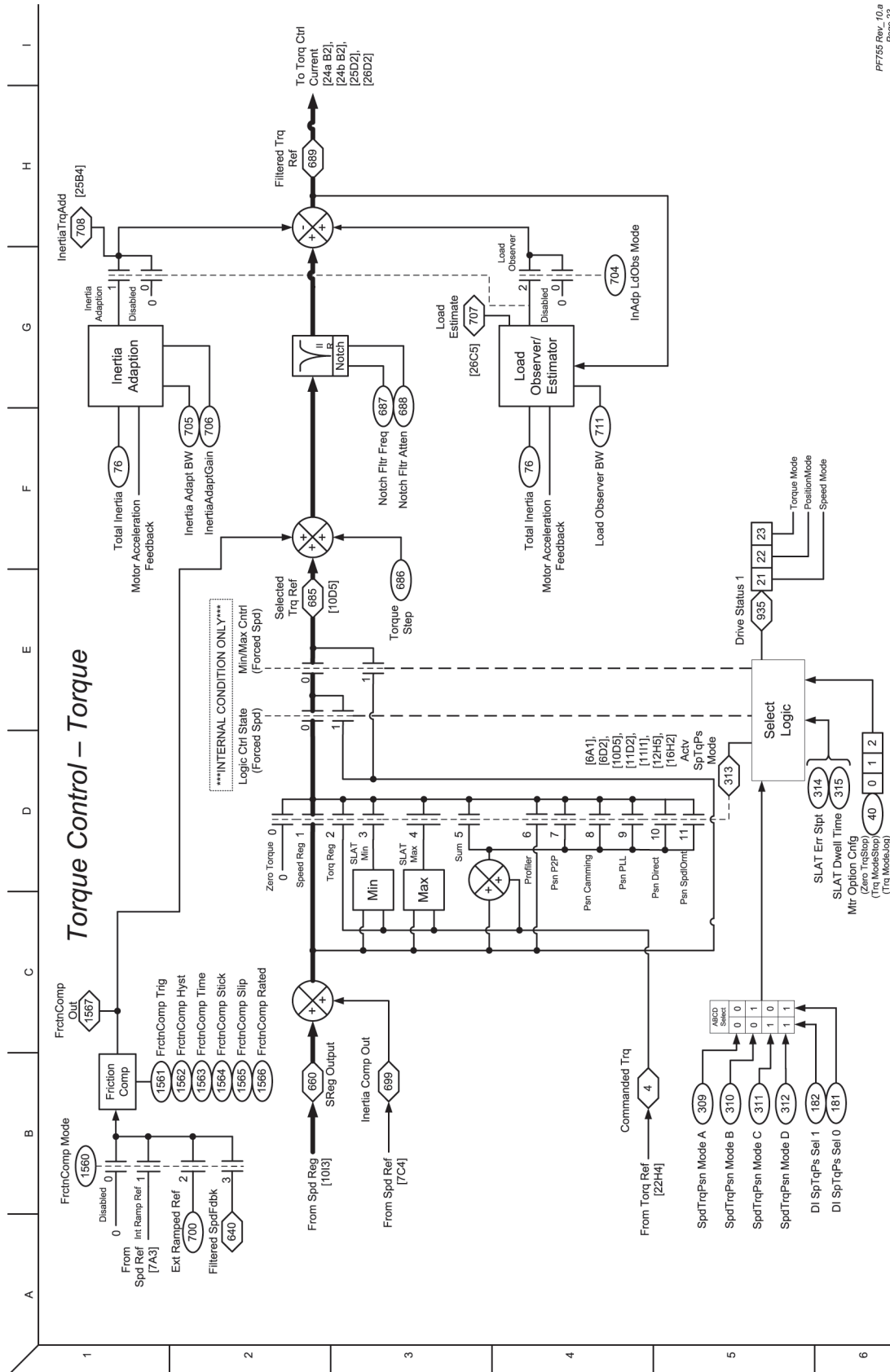
PF755 Rev\_10.a  
Page 21b

**Figure 60 - Torque Control - Reference Scale & Trim**



PF755 Rev. 10.0  
Page 22

Figure 61 - Torque Control - Torque



PF755 Rev\_10.a  
Page 23





Figure 64 - Torque Control - Inertia Adaption

PFT755 Rev. 10.0  
Page 25

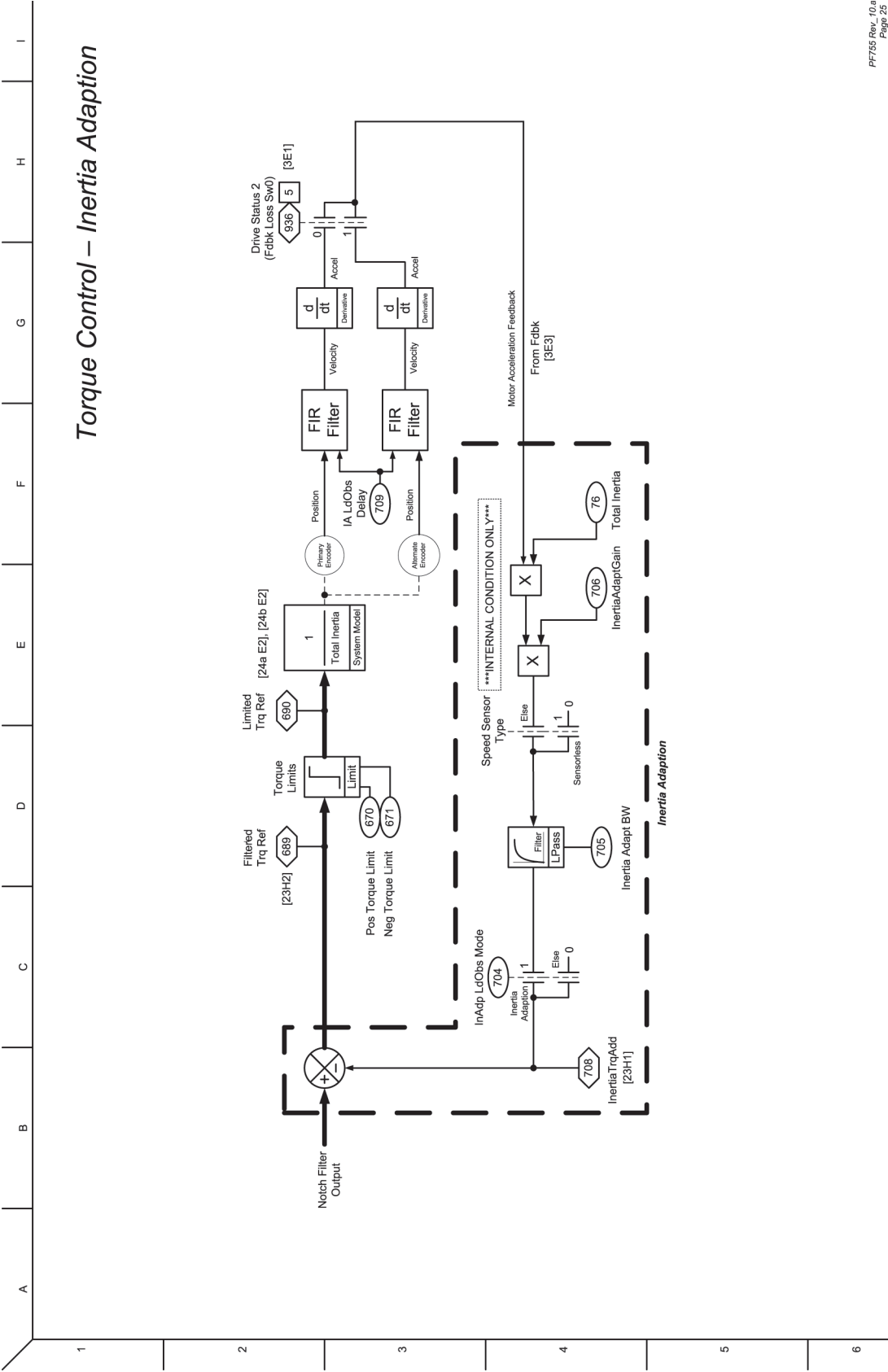
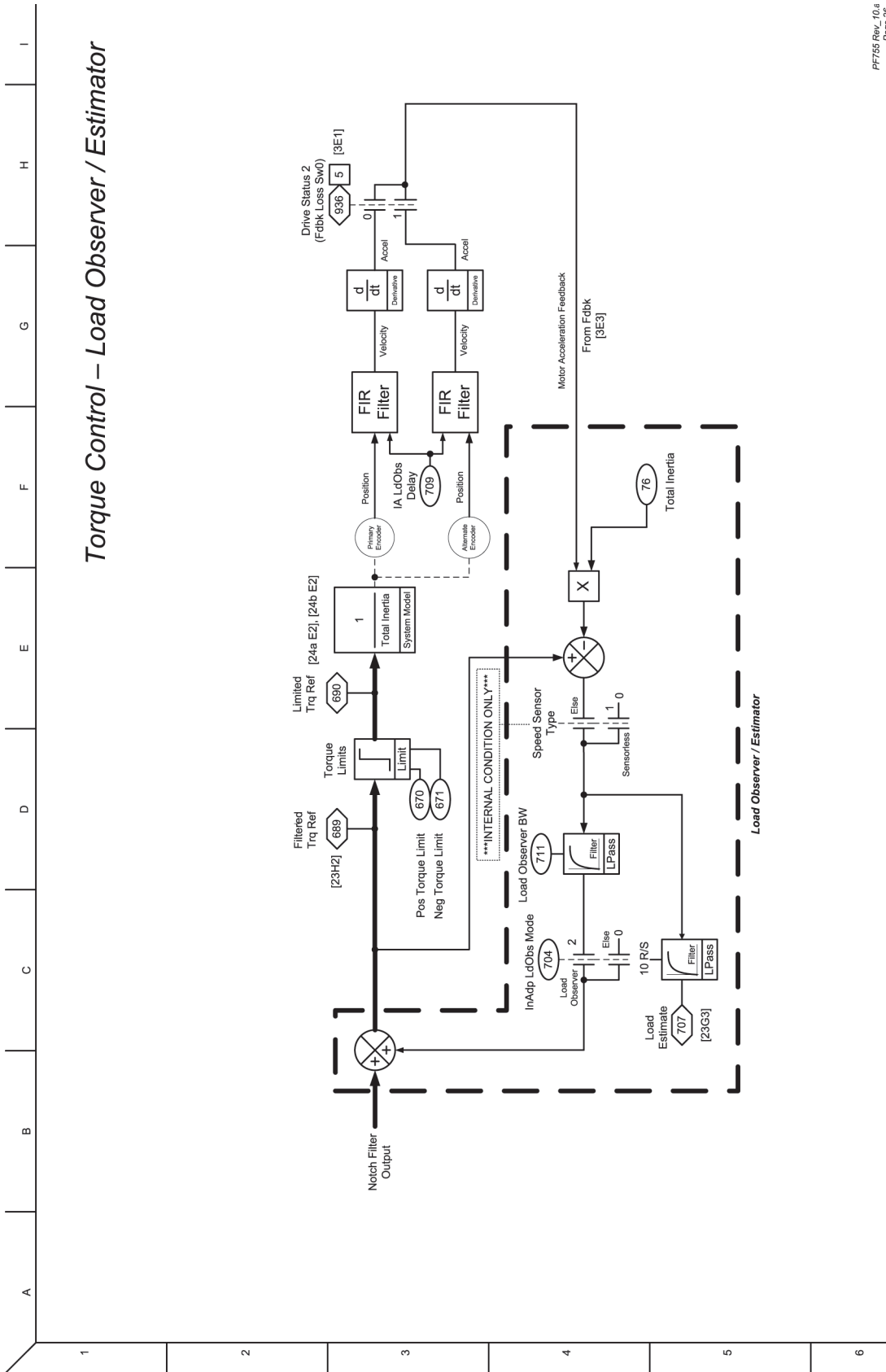


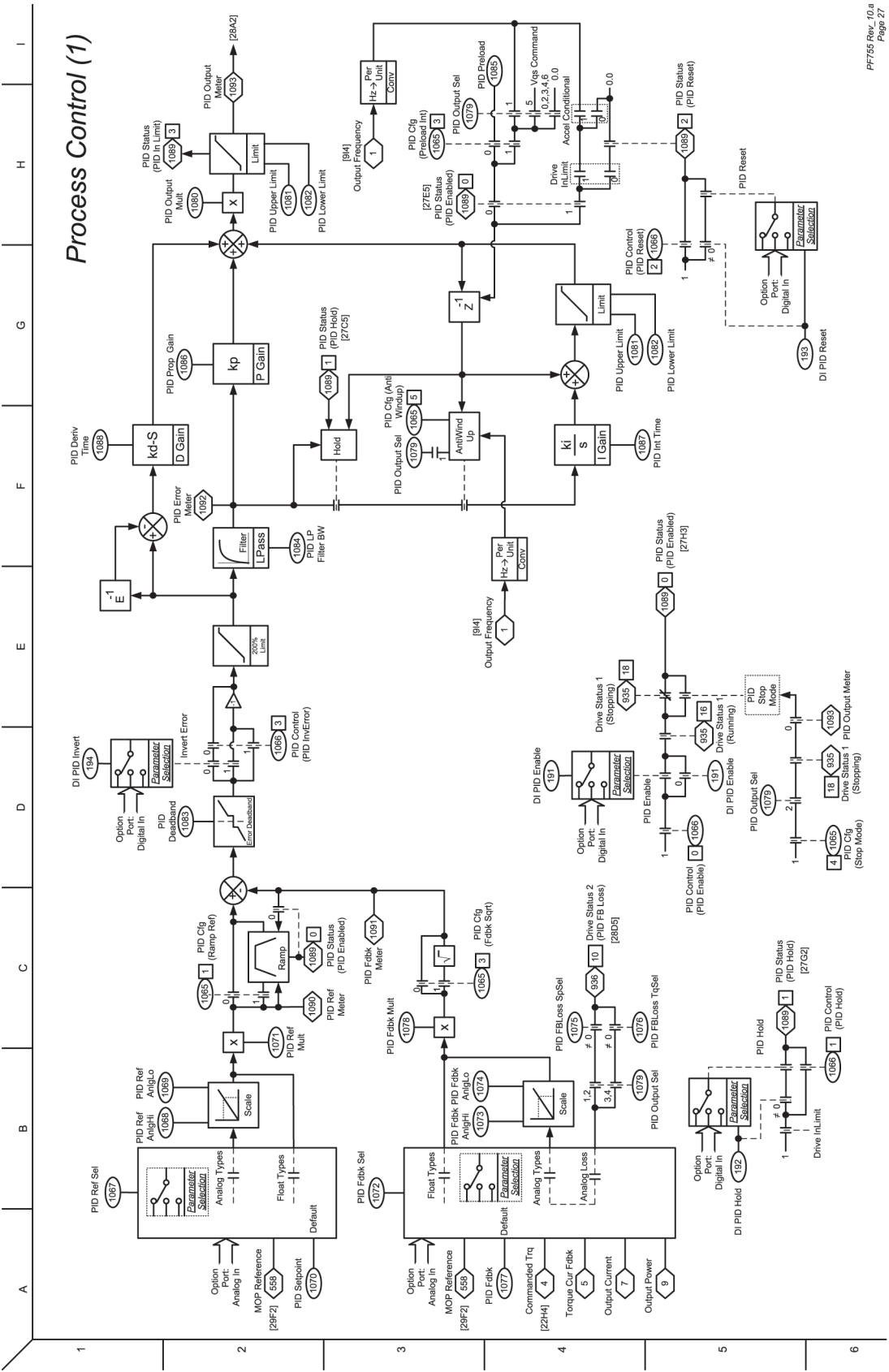
Figure 65 - Torque Control - Load Observer / Estimator



PF755 Rev\_10.a  
Page 26



Figure 66 - Process Control (1)



PF755 Rev. 10.8 Page 27

Figure 67 - Process Control (2)

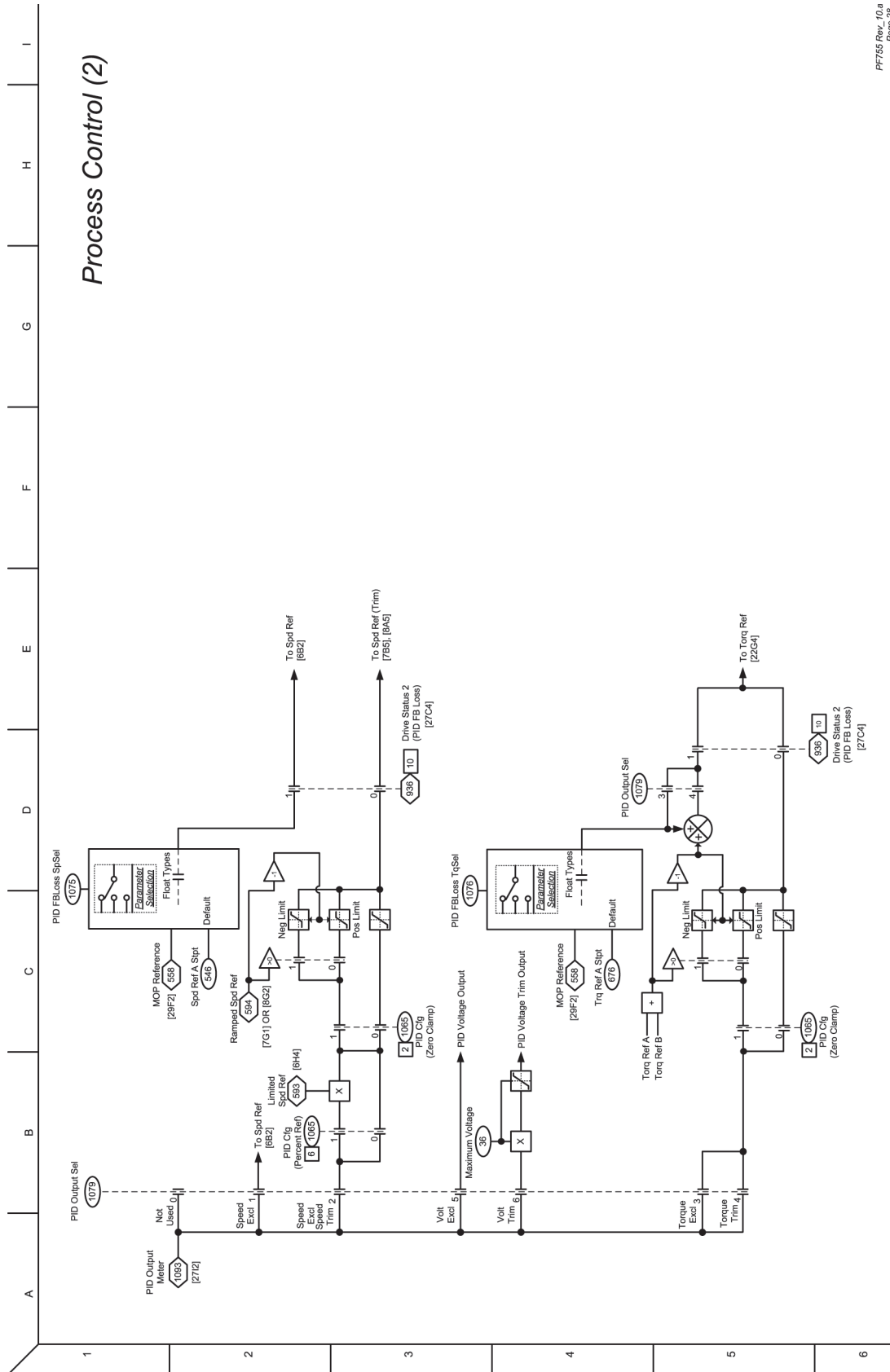
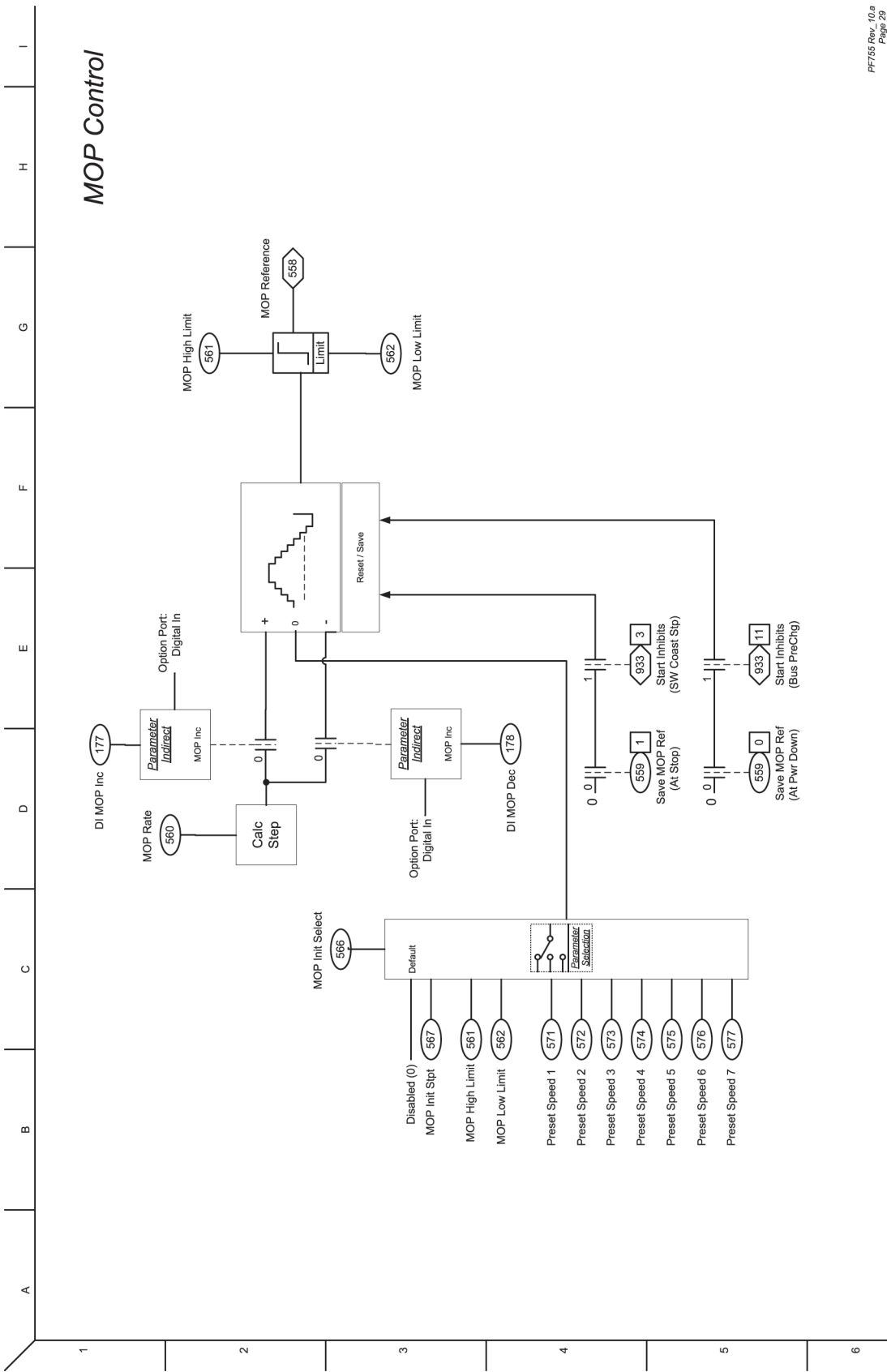
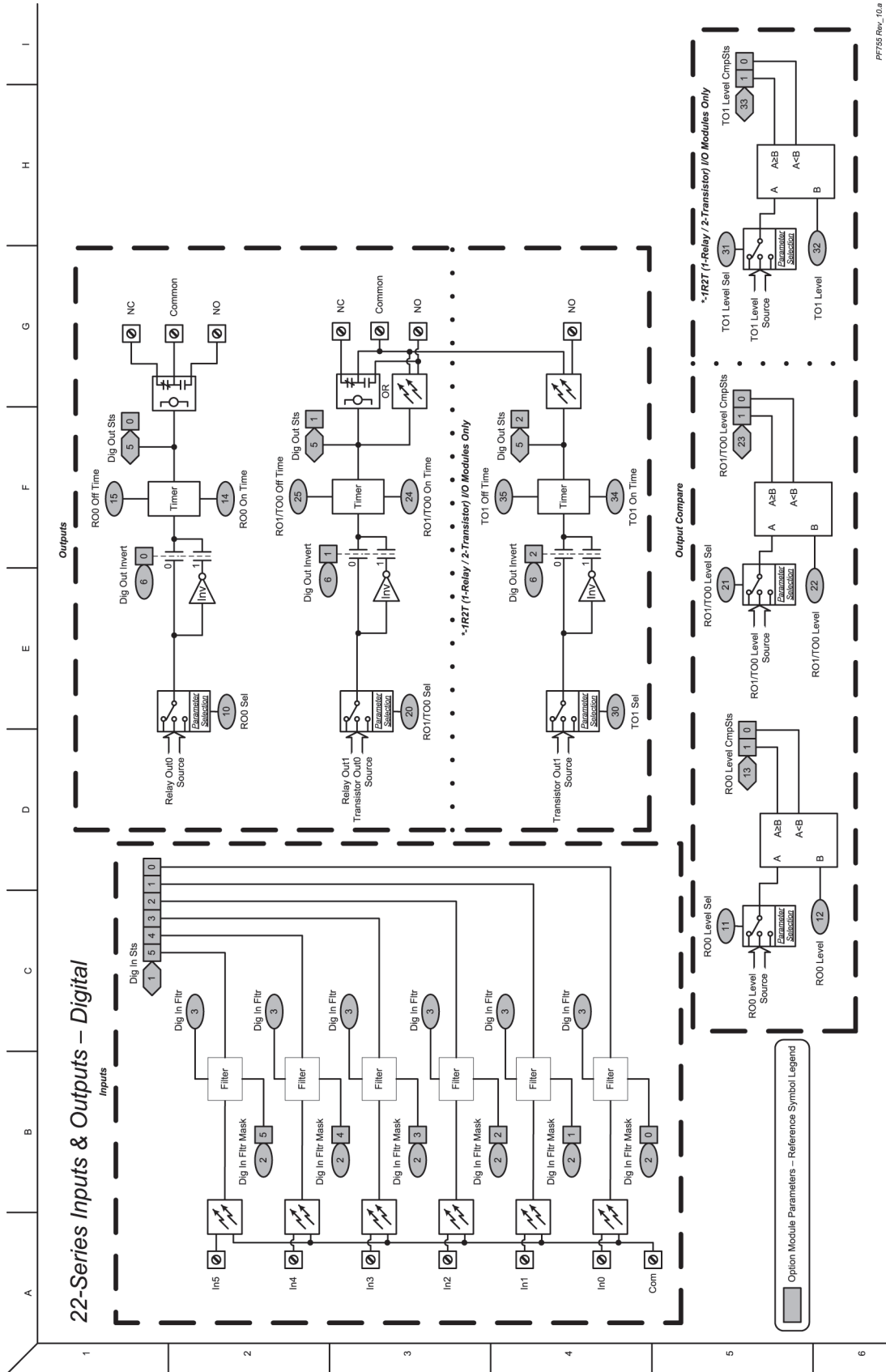


Figure 68 - MOP Control

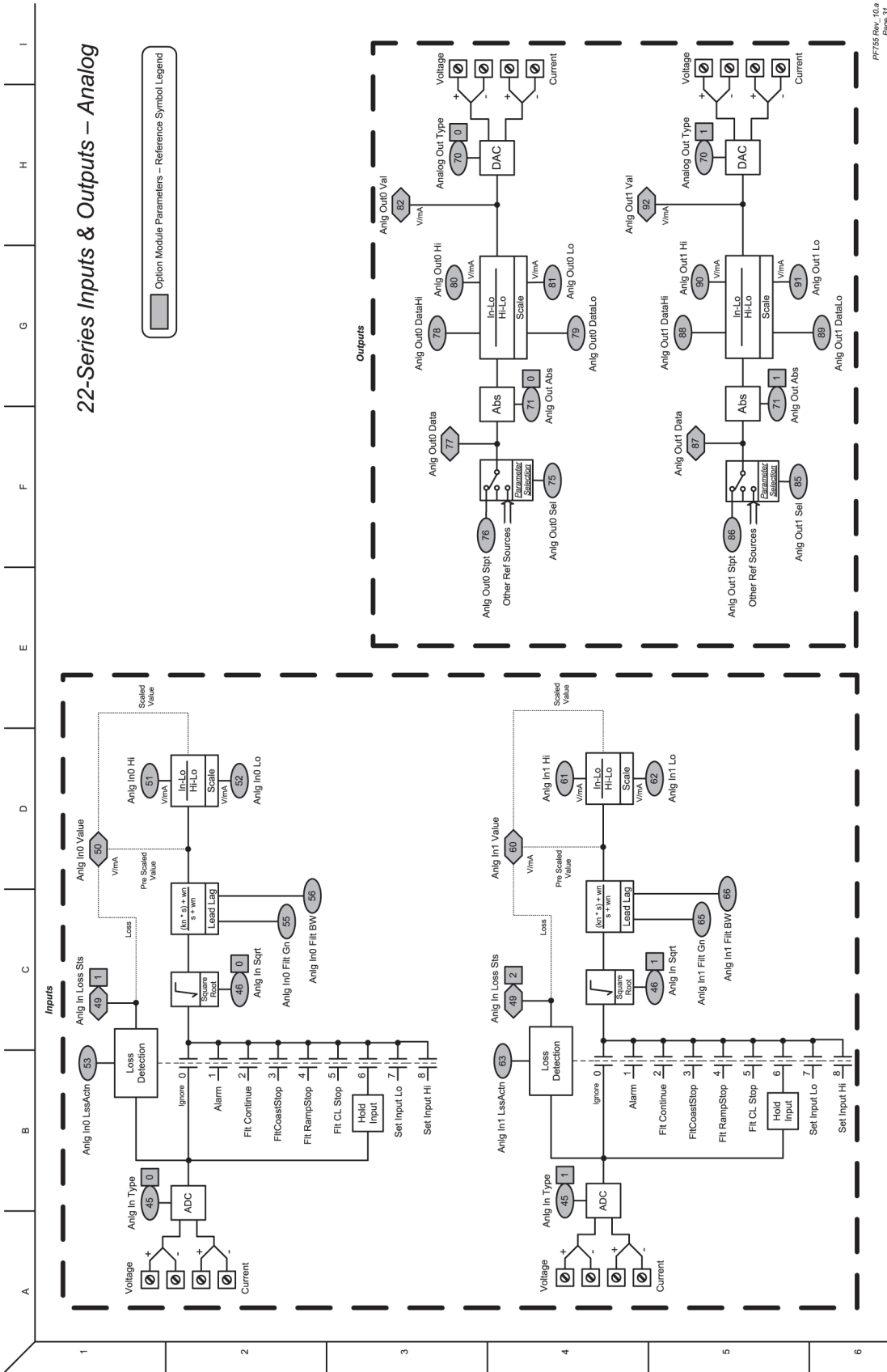


PF755 Rev. 10.8  
Page 29

Figure 69 - 22-Series Inputs & Outputs - Digital

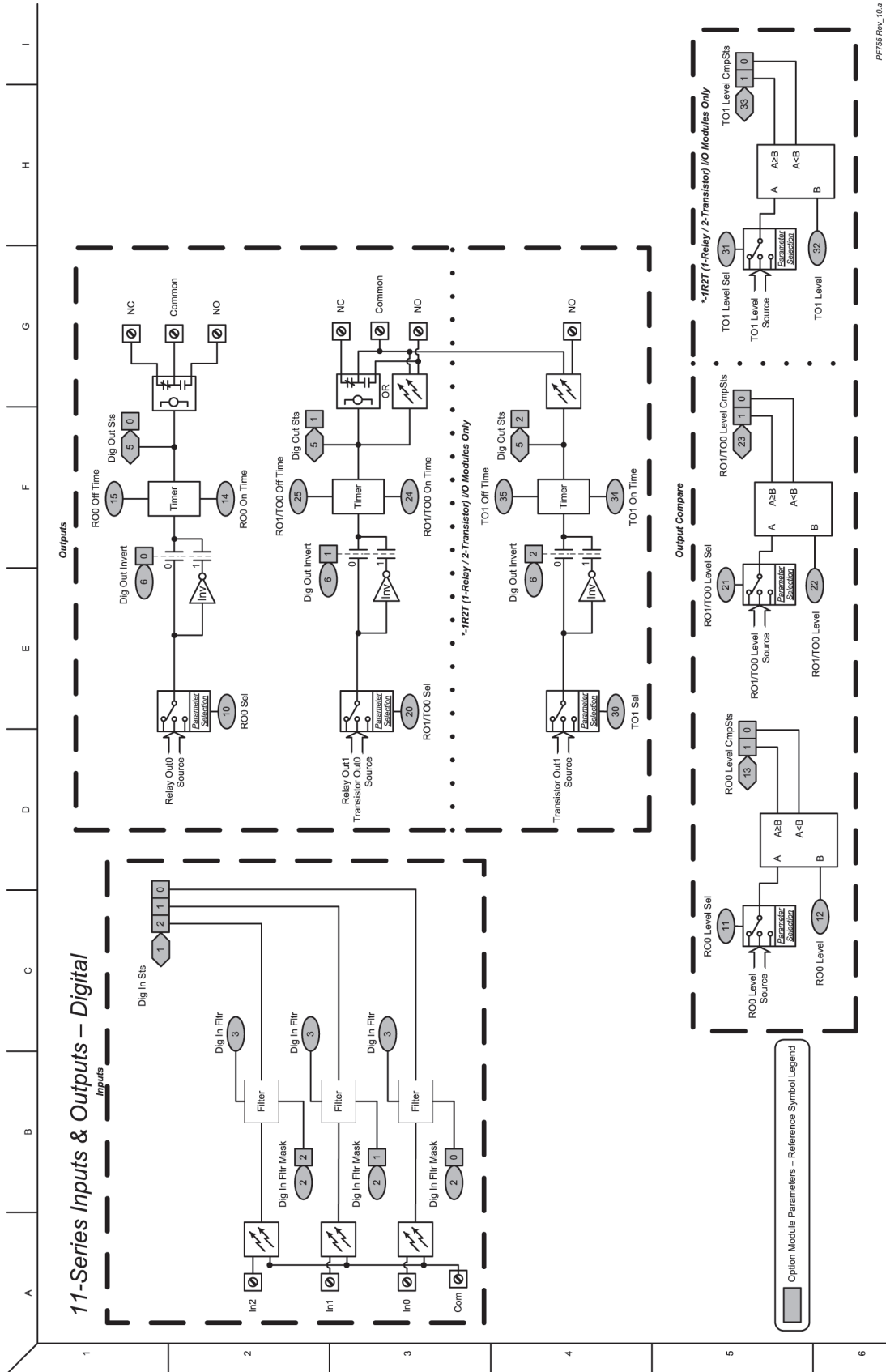


**Figure 70 - 22-Series Inputs & Outputs - Analog**



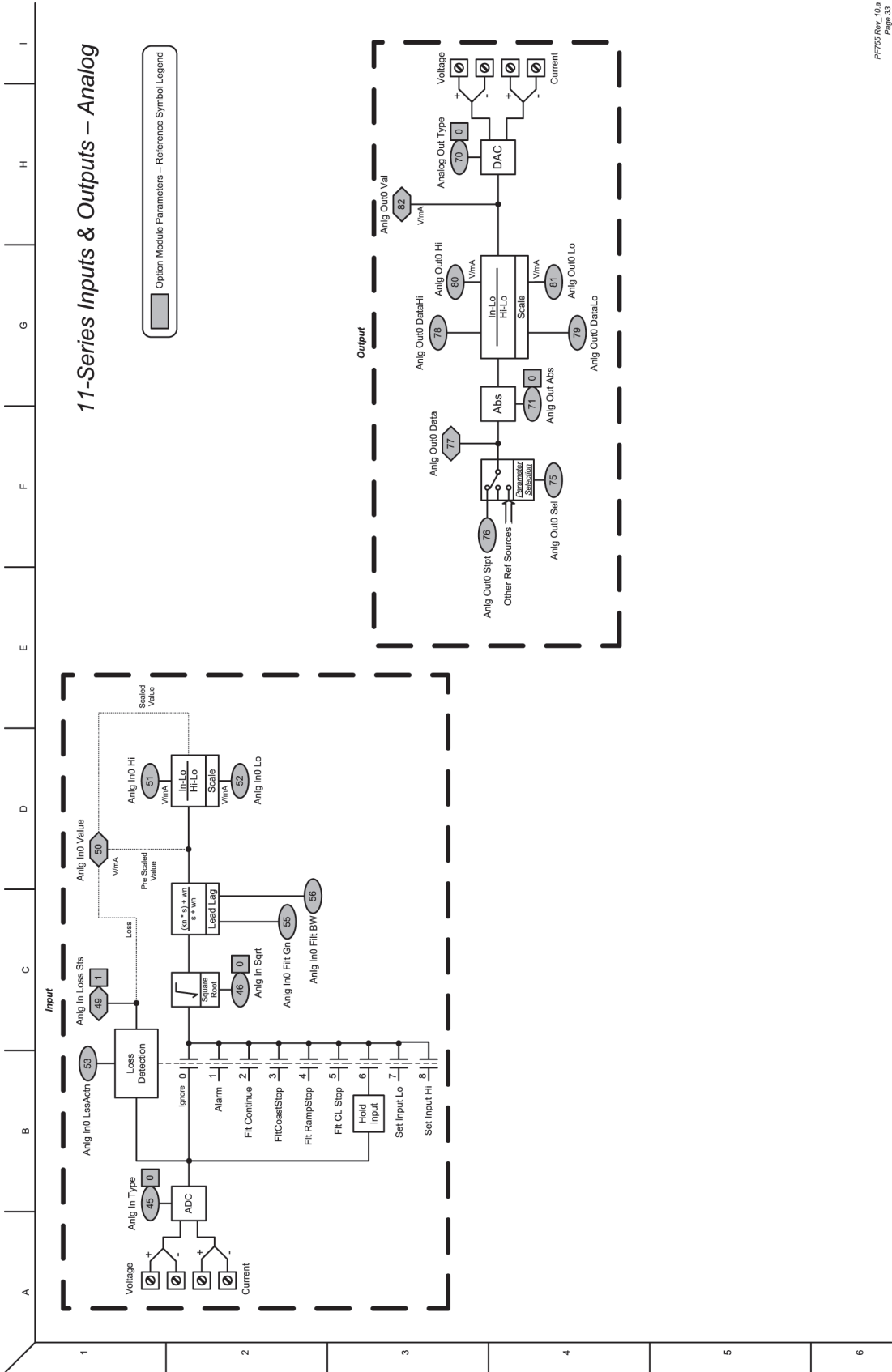
P7755 Rev. 10.0  
Page 31

Figure 71 - 11-Series Inputs & Outputs - Digital



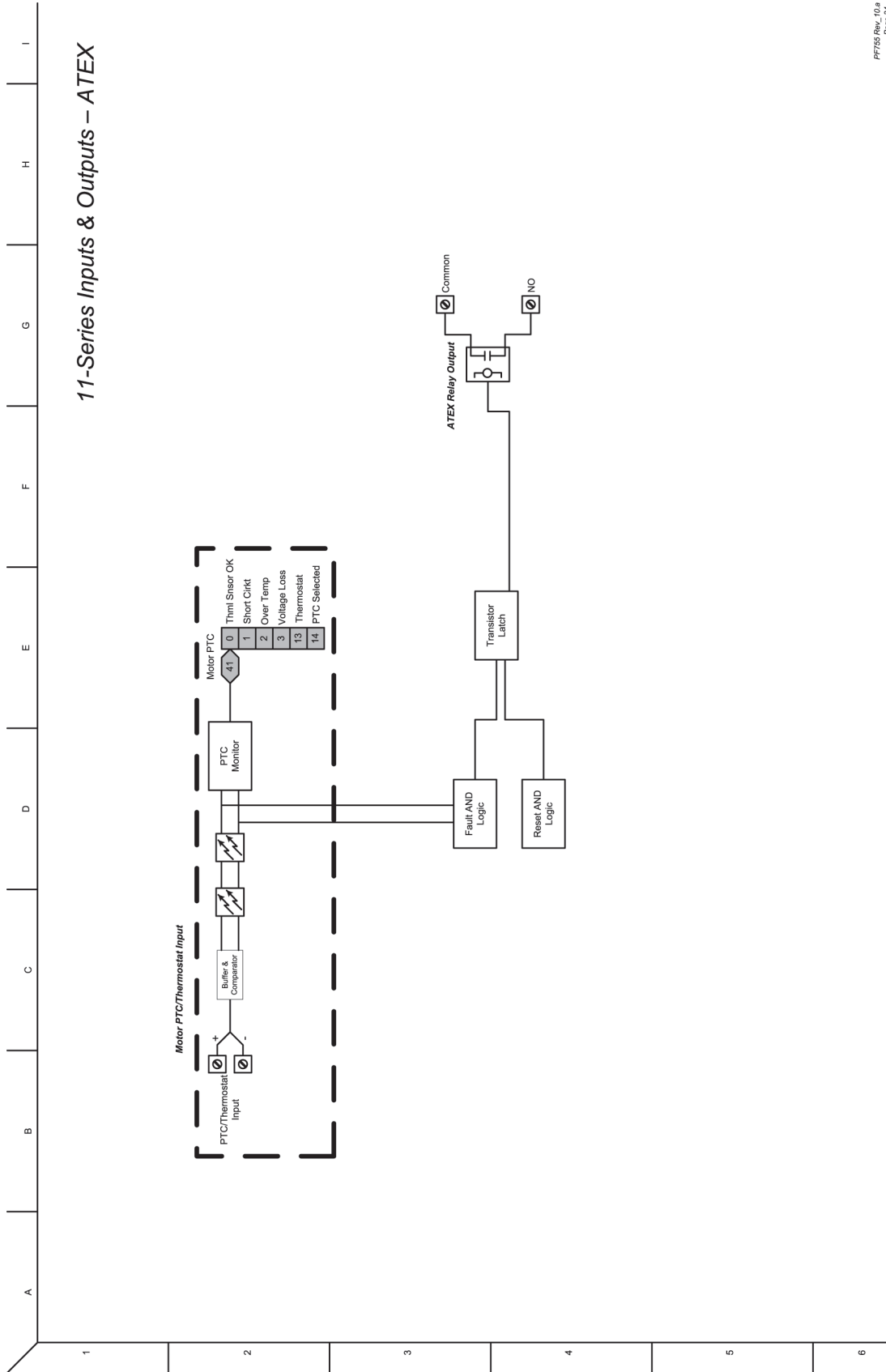
PFF755 Rev. 10.a  
Page 32

**Figure 72 - 11-Series Inputs & Outputs - Analog**



PF755 Rev. 10.9  
Page 33

Figure 73 - 11-Series Inputs & Outputs - ATEX



PFT55 Rev. 10.0  
Page 34



**Figure 74 - Control Logic**

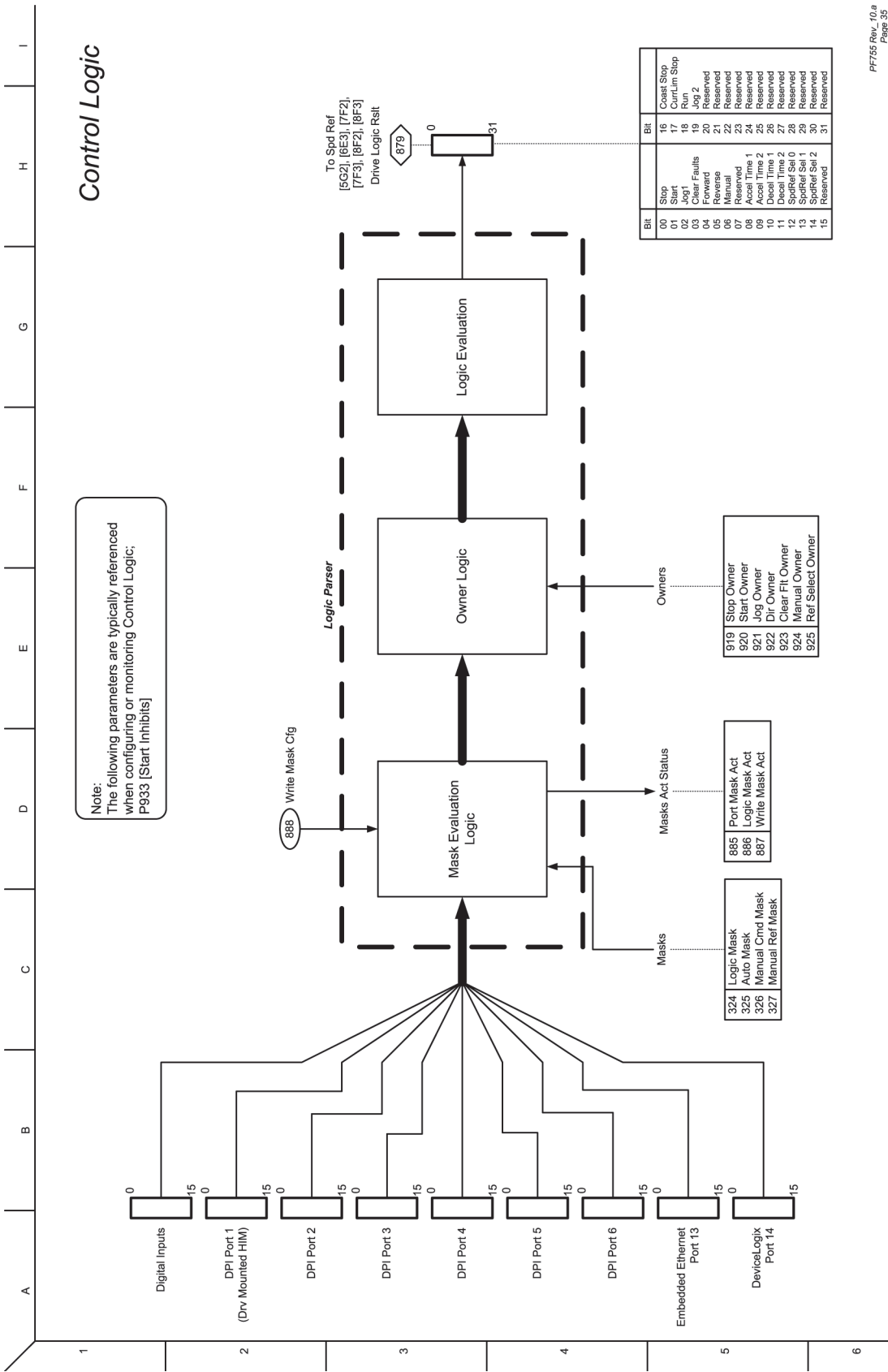
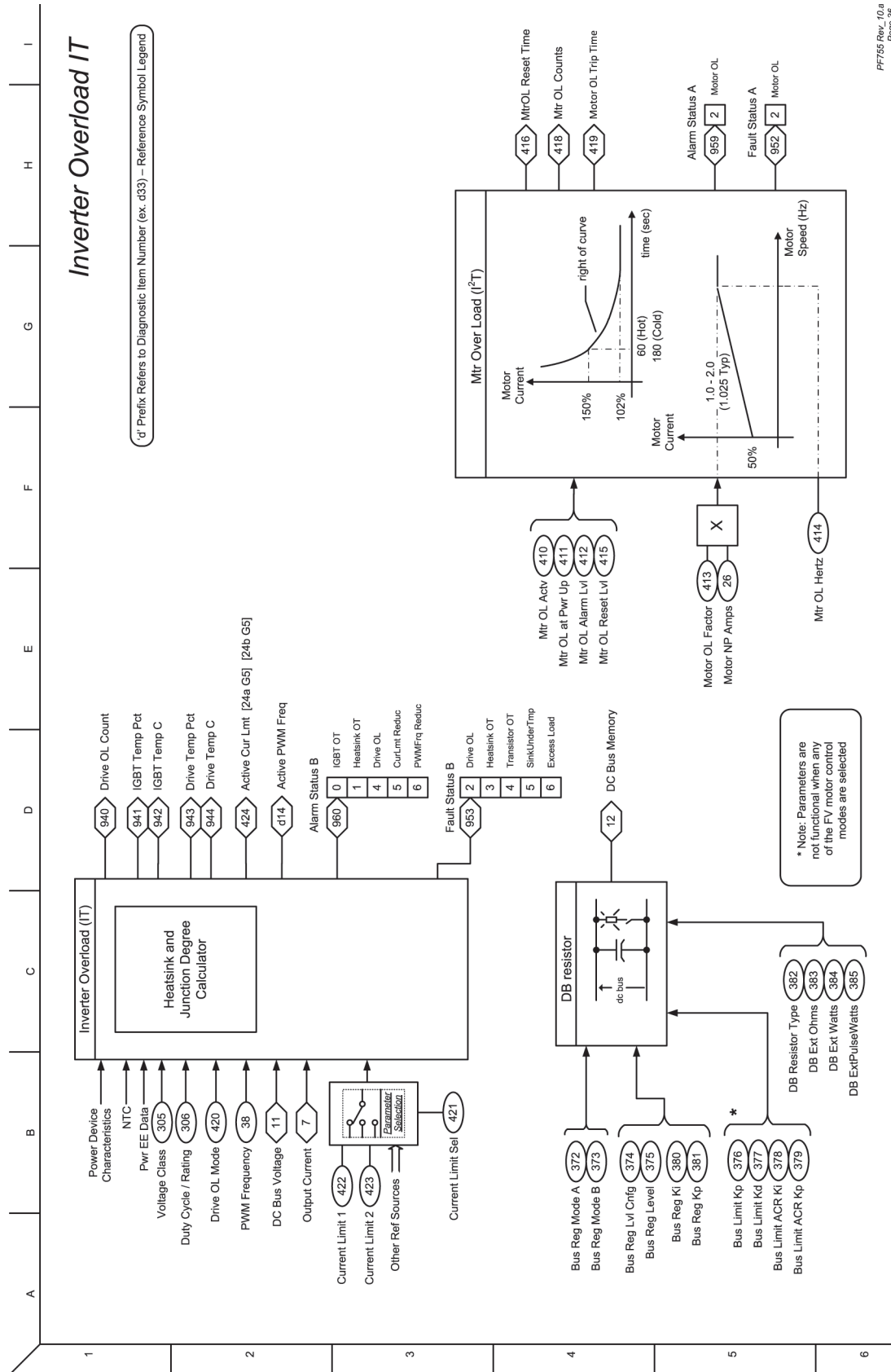
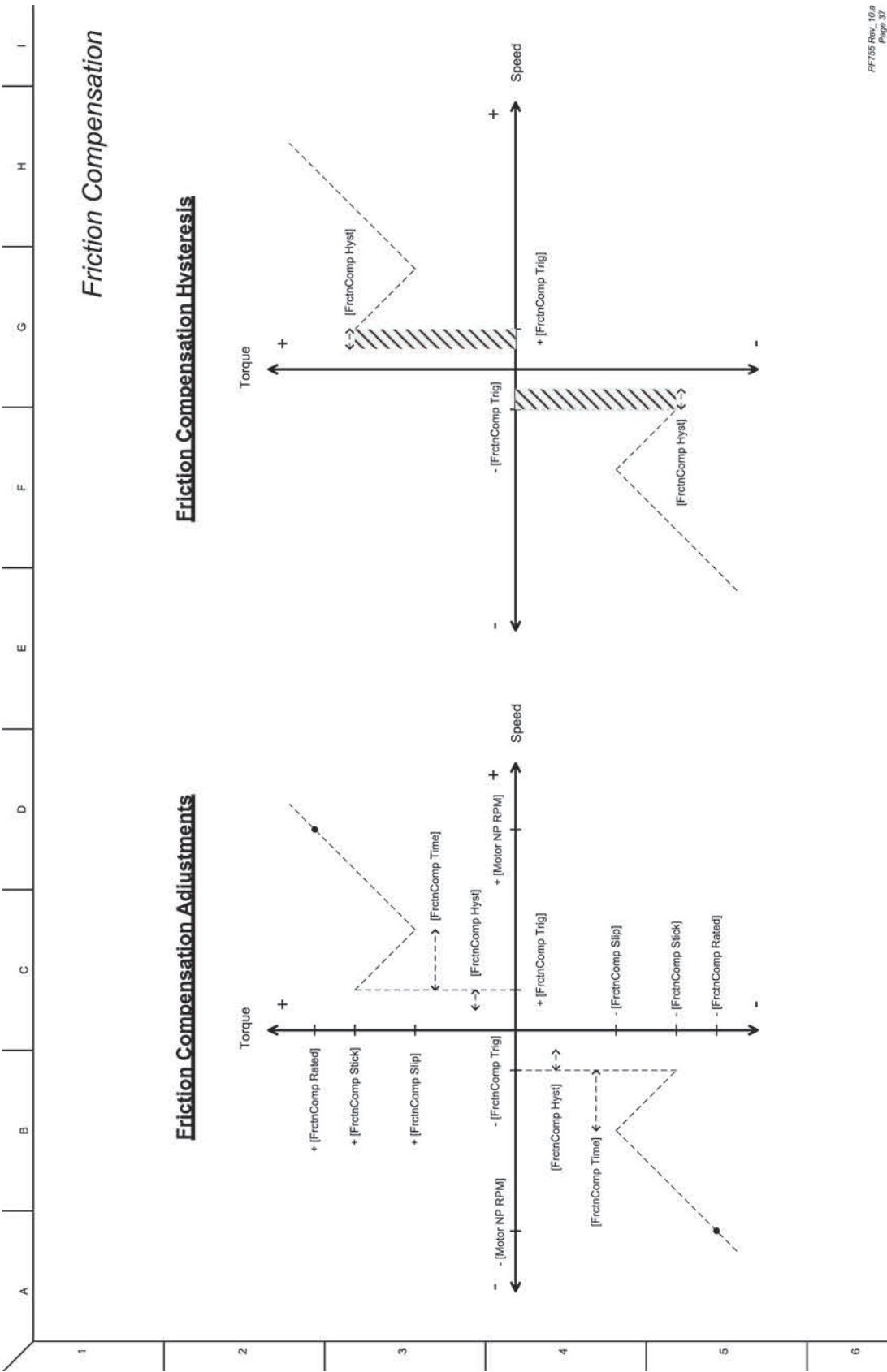


Figure 75 - Inverter Overload IT



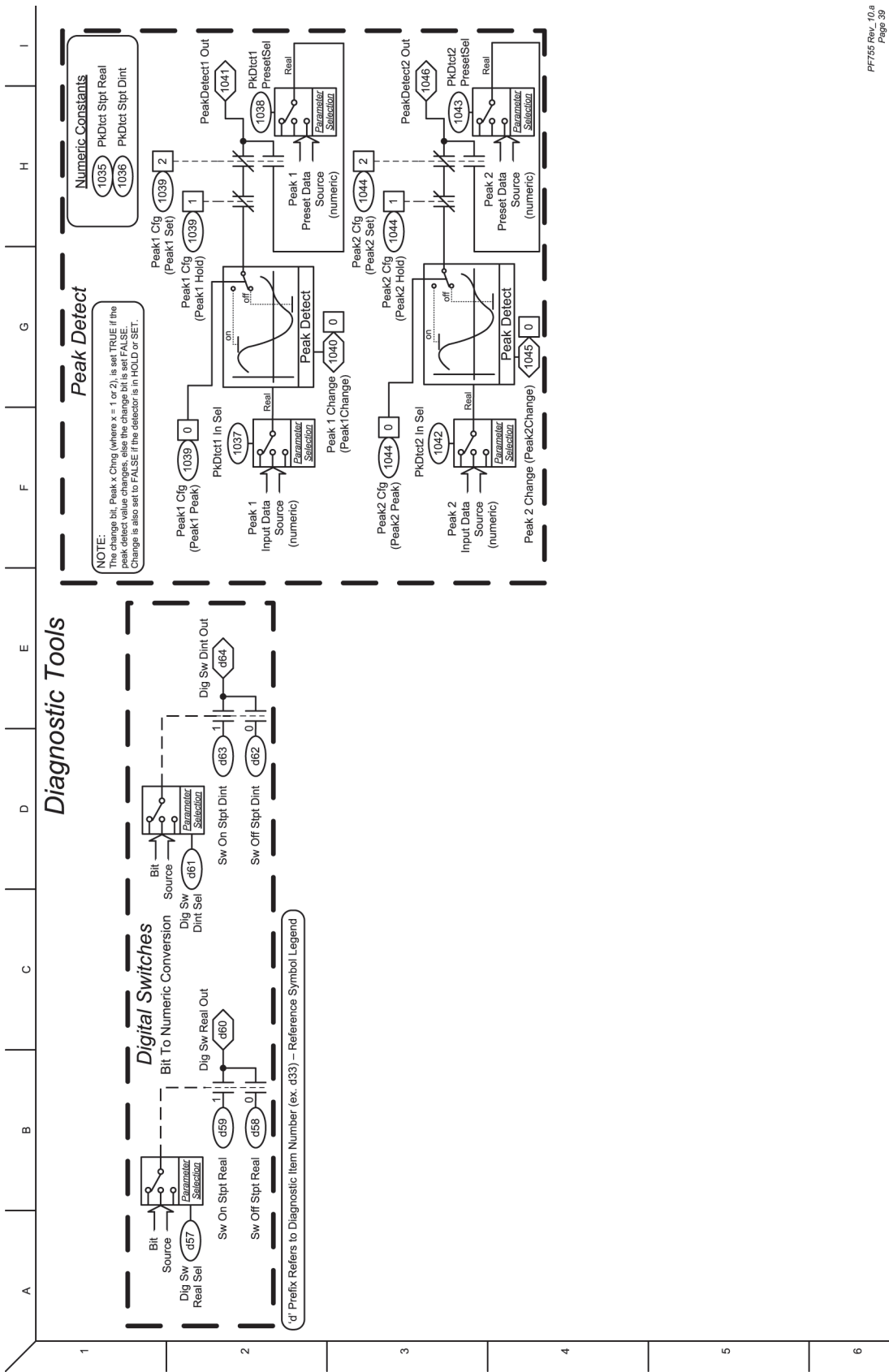
PF755 Rev. 10.a  
Page 36

**Figure 76 - Friction Compensation**



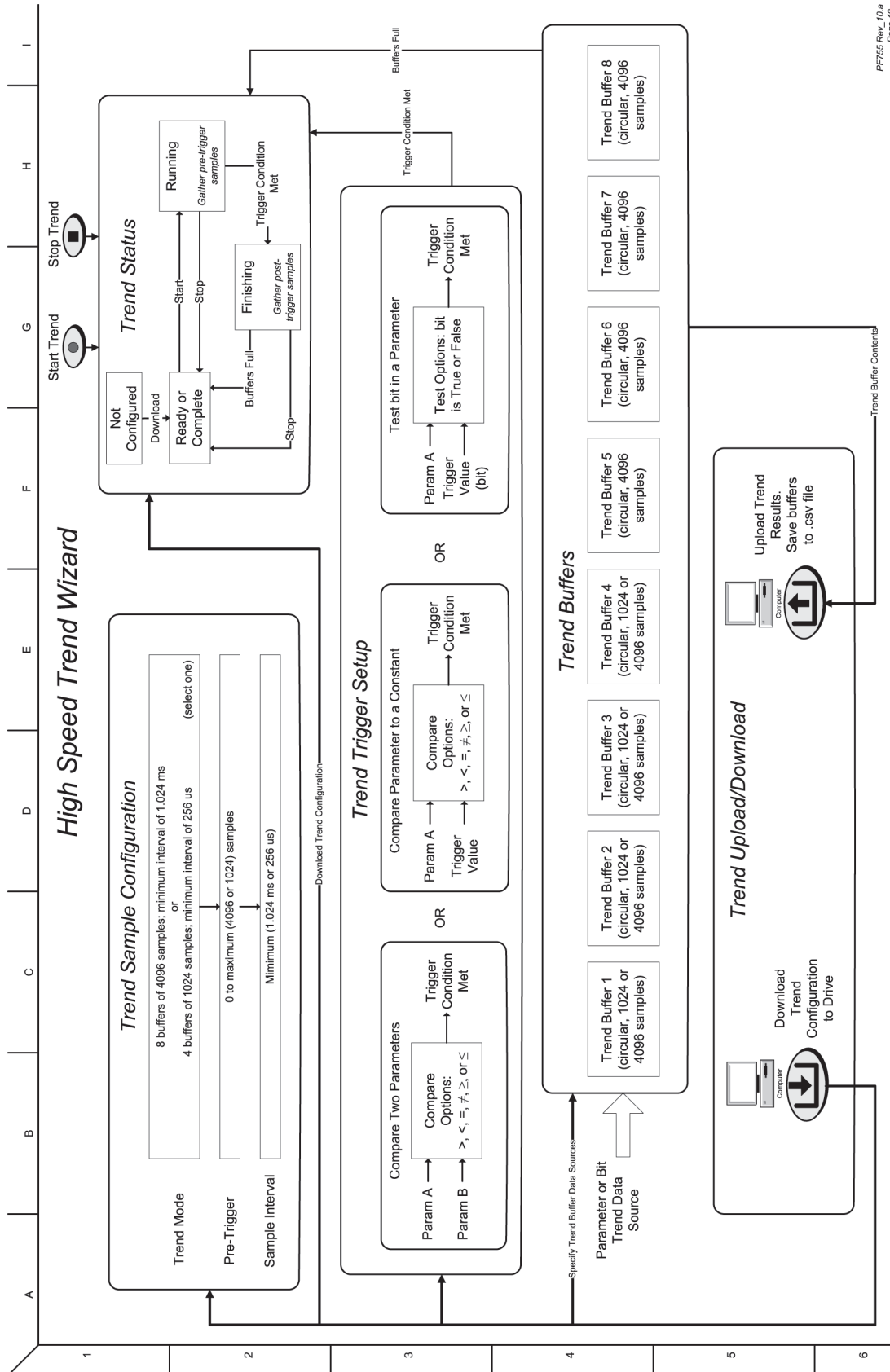
PF755 Rev. 10.9  
Page 37





PF755 Rev. 10.a  
Page 39

### High-Speed Trend Wizard



PF755 Rev. 10.a  
Page 40

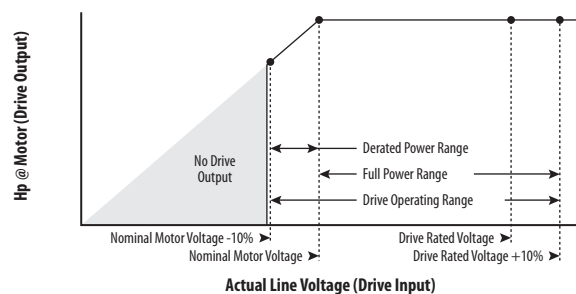
## Application Notes

### Voltage Tolerance

Drive Rating	Nominal Line Voltage	Nominal Motor Voltage	Drive Full Power Range	Drive Operating Range
380...400	380	380	380...528	342...528
	400	400	400...528	
	480	460	460...528	

Drive Full Power Range = Nominal Motor Voltage to Drive Rated Voltage 10%.  
Rated current is available across the entire Drive Full Power Range

Drive Operating Range = Lowest Nominal Motor Voltage - 10% to Drive Rated Voltage 10%.  
Drive Output is linearly derated when Actual Line Voltage is less than the Nominal Motor Voltage

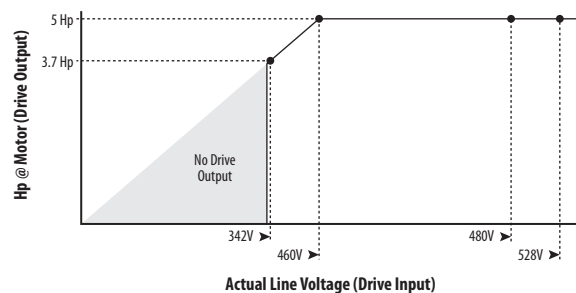


#### Example:

Calculate the maximum power of a 5 Hp, 460V motor that is connected to a 480V rated drive supplied with 342V Actual Line Voltage input.

- Actual Line Voltage / Nominal Motor Voltage = 74.3%
- $74.3\% \times 5 \text{ Hp} = 3.7 \text{ Hp}$
- $74.3\% \times 60 \text{ Hz} = 44.6 \text{ Hz}$

At 342V Actual Line Voltage, the maximum power the 5 Hp, 460V motor can produce is 3.7 Hp at 44.6 Hz.



## PowerFlex 755 Lifting/ Torque Proving

TorqProve™ is a PowerFlex® 755 drive feature that is intended for applications where proper coordination between motor control and a mechanical brake is required. Before releasing a mechanical brake, the drive checks motor output phase continuity and verifies proper motor control (torque proving). The drive also verifies that the mechanical brake has control of the load before the releasing drive control (brake proving). After the drive sets the brake, motor movement is monitored to help ensure the brake can hold the load.



**ATTENTION:** Loss of control in suspended load applications can cause personal injury and/or equipment damage. The drive or a mechanical brake must always control the loads. Parameters 1100 . . . 1113 are designed for lifting/torque prove applications. It is the responsibility of the engineer and/or end user to configure drive parameters, test any lifting functionality and meet safety requirements in accordance with all applicable codes and standards.

TorqProve can be operated with an encoder or encoderless. See “Attention” on [page 372](#) before the use of TorqProve with no encoder.

TorqProve functionality with an encoder includes:

- Torque Proving (includes flux up and last torque measurement)
- Brake Proving
- Brake Slip (feature slowly lowers load if brake slips/fails)
- Float Capability (ability to hold full torque at zero speed)
- Micro positioning
- Fast Stop
- Speed Deviation Fault, Output Phase Loss Fault, Encoder Loss Fault.

Encoderless TorqProve functionality includes:

- Torque Proving (includes flux up and last torque measurement)
- Micro positioning
- Fast Stop
- Speed Deviation Fault, Output Phase Loss Fault.

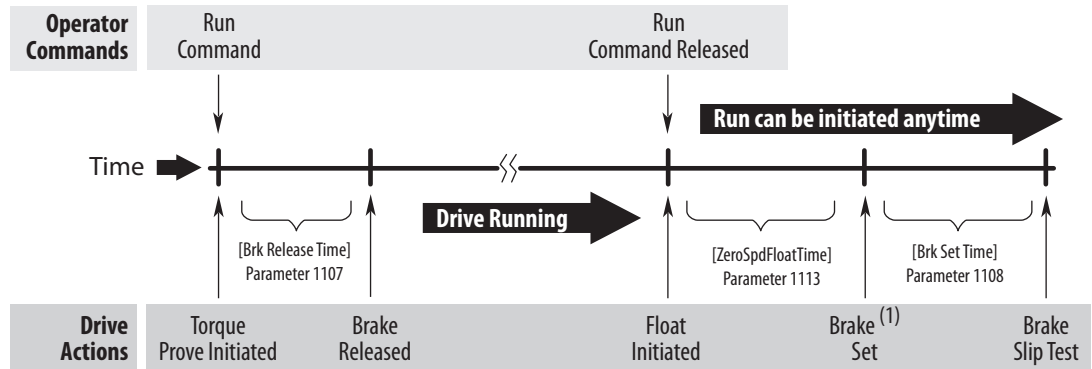
---

**IMPORTANT** Brake Slip detection and Float capability (ability to hold load at zero speed) are not available in encoderless TorqProve.

---

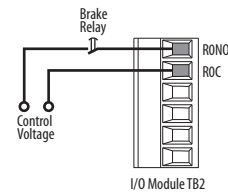


**Figure 79 - Torque Proving Flow Diagram**



All times between Drive Actions are programmable and can be made very small (i.e. Brake Release Time can be 0.1 seconds)

- (1) For torque proving to function properly, wire a mechanical brake to a relay output on a digital I/O option module. On the I/O module, set P10 [R00 Sel] to Port 0, P1103 [Trq Prove Status] Bit 4 "Brake Set" and set P6 [Dig Out Invert] Bit 0 "Relay Out 0" = 1.



### Tuning the Motor for Torque Prove Applications

It is possible to use the startup routine to tune the motor ([See page 19](#)). However, it is recommended to disconnect the motor from the hoist/crane equipment during the routine.



**ATTENTION:** To guard against personal injury and/or equipment damage due to an unexpected brake release, verify the digital output that is used for brake connections and/or programming. The PowerFlex 755 drive **does not control the mechanical brake until TorqProve is enabled**. If the brake is connected to a digital output, it could be released. If necessary, **disconnect the digital output until wiring/programming can be completed and verified**.

## Crane Set up with Encoder Feedback

These setup instructions assume the following.

- Drive and motor size have been carefully selected
- External brake resistor has been properly sized
- The drive is at factory defaults.  
If not, unplug the output relay terminal block and issue a reset to factory defaults for the HOST and all PORTS. Plug terminal block back in.
- Programming is done via DriveExecutive™, DriveExplorer™, or Connected Components Workbench™ software.
- Crane control is done via Run forward / Run Reverse inputs
- Mechanical brake control is wired to Output Relay 0
- The drive is equipped with an incremental (20-750-ENC-1), a dual incremental encoder board (20-750-DENC-1), or a universal feedback encoder (20-750-UFB-1).
- The encoder is mounted on the back of the motor (not behind the gearbox)
- Encoder specification: Quadrature differential (A, A-, B, B-), Line driver output, Minimum 1000PPR 5V, or 12V signals (12V preferred)



**ATTENTION:** Loss of control in suspended load applications can cause personal injury and/or equipment damage. The drive or a mechanical brake must always control the loads. Parameters 1100 . . . 1113 are designed for lifting/torque prove applications. It is the responsibility of the engineer and/or end user to configure drive parameters, test any lifting functionality and meet safety requirements in accordance with all applicable codes and standards.

---

## Set Up the Drive

1. Adjust parameter settings and enter nameplate data.

Parameter	Setting
<b>Brake Details</b>	
P370 [Stop Mode A]	1 "Ramp"
P372 [Bus Reg Mode A]	2 "Dyn Brake" (Dynamic Braking)
P382 [DB Resistor Type]	1 "External"
P383 [DB Ext Ohms]	Total Ohm value of external resistor.
P384 [DB Ext Watts]	Total real watt rating of external resistor.
P385 [DB ExtPulseWatts]	Maximum value for properly sized resistor.
P426 [Regen Power Lmt]	-800 % (Minimum Value)
<b>Motor Nameplate Data</b>	
P25 [Motor NP Volts]	Motor nameplate voltage.
P26 [Motor NP Amps]	Motor nameplate current.
P27 [Motor NP Hertz]	Motor nameplate frequency.
P28 [Motor NP RPM]	Motor nameplate speed.
P29 [Mtr NP Pwr Units]	0 "HP" or 1 "kW"
P30 [Motor NP Power]	Motor nameplate power rating.
P31 [Motor Poles]	Number of motor poles.
<b>Motor Control</b>	
P35 [Motor Ctrl Mode]	3 "Induction FV"
<b>Maximum Frequency</b>	
P37 [Maximum Freq]	Motor nameplate frequency.
<b>Drive Duty Rating</b>	
P306 [Duty Rating]	1 "Heavy Duty"
<b>Overload Hertz</b>	
P414 [Mtr OL Hertz]	0.00 (Ensures that no current derating is applied.)
<b>Autotune Torque</b>	
P71 [Autotune Torque]	100.00 % (Used during rotate tuning and inertia tuning.)
<b>Protection</b>	
P420 [Drive OL Mode]	1 "Reduce PWM"
P422 [Current Limit 1]	200 % of P26 [Motor NP Amps]
P444 [OutPhaseLossActn]	3 "FltCoastStop"

## Motor Tune Routines

### Static Tune

This routine measures the motor characteristics with the brake set (brake closed).

### Rotate Tune

This routine gives better results if connected equipment allows. This routine requires the mechanical brake to open and the motor be allowed to run at minimum of 70 % of nominal speed.

### Inertia Tune

This routine measures the time to accelerate the system to the nominal speed.

## Static Tune


During a Static Tune, the mechanical brake remains set.

1. Enter Static Tune parameter settings.

Drive Parameter	Setting
P70 [Autotune]	2 "Static Tune"

I/O Module Parameter (Port X)	Setting
P10 [R00 Sel]	0.00 "Disabled"

2. To open the Control Bar, click the Controls icon .

3. Press the Start button on the Control Bar.

When the Static Tune routine is complete, P70 [Autotune] changes to 0 "Ready."

### Verify Drive Direction

1. Perform a Direction Test to verify proper direction of crane.

I/O Module Parameter (Port n)	Setting
P164 [DI Run Forward]	Port Number, P1 [Dig In Sts], Bit n (Run Fwd Input)
P165 [DI Run Reverse]	Port Number, P1 [Dig In Sts], Bit n (Run Rev Input)

**IMPORTANT** The crane can be started via the crane control unit.

Drive Parameter	Setting
P545 [Spd Ref A Sel]	Port 0, P571 [Preset Speed 1]
P571 [Preset Speed 1]	15 Hz (Set to low speed for direction test.)
P535 [Accel Time 1]	2.00 Secs
P537 [Decel Time 1]	2.00 Secs

I/O Module Parameter (Port X)	Setting
P10 [R00 Sel]	Port 0, P935 [Drive Status 1], Bit 16 "Running"

**IMPORTANT** The mechanical brake opens when the drive is running.

2. Run crane with the crane control unit and verify that the direction is correct.

If crane direction is not correct, change motor direction.

Drive Parameter	Setting
P40 [Mtr Options Cfg]	Bit 4 "Mtr Lead Rev" = 1 (Reversed)

Run crane with the crane control unit and verify that the direction is now correct.

Move crane hook to a position that allows sufficient travel in both directions.

### Verify Encoder Direction

1. If a Dual Incremental-Encoder option module (20-750-DENC-1) is used, and only one encoder is connected, disable the encoder loss fault of the unused channel.

Drive Parameter	Setting
P132 [Aux Vel Fdbk Sel]	Encoder Port Number, Enc 0 FB (Selects Channel 0)
Encoder Module Parameter (Port X)	Setting
P13 [Enc 1 FB Lss Cfg]	0 "Ignore" (Disables Channel 1)
P2 [Enc 0 PPR]	Real pulses per revolution (For example 1024).

2. Run the crane upwards or downwards and monitor the sign (+ or -) of the output frequency on the HIM display or via software. Compare this sign to the sign of P134 [Aux Vel Feedback]. Both signals must have the same sign (both positive or both negative).

If signals do not match, change the encoder direction setting.

Encoder Module Parameter (Port X)	Setting
P1 [Enc 0 Cfg]	Bit 5 "Direction" = 1 (Invert)

3. Run the crane upwards or downwards and check if the sign of both speeds matches.

Drive Parameter	Setting
P125 [Pri Vel Fdbk Sel]	Encoder Port Number, P1 [Dig In Sts]

The encoder direction now matches the motor direction.

### Rotate Tune

During a Rotate Tune routine, the motor runs for 20 seconds in the commanded direction. In Flux vector control, the Rotate Tune routine can be executed in a no load or lightly loaded condition such as the motor connected to a gearbox, cable drum, or cable and hook.

---

**IMPORTANT** Ensure that the Rotate Tune routine can be stopped if an end travel condition is likely to occur.

---

If the motor is connected to a load, determine whether there is enough travel distance for the Rotate Tune sequence to complete. If necessary, run the crane hook to top or bottom for more travel distance in the opposite direction.

If the Rotate Tune routine fails due to a motor load, rerun the Static Tune routine and skip this routine.

1. Enter Rotate Tune parameter settings.

Drive Parameter	Setting
P70 [Autotune]	3 "Rotate Tune"
P520 [Max Fwd Speed]	Forward speed limit that is used during Autotune. 70 % P27 [Motor NP Hertz] minimum.
P521 [Max Rev Speed]	Reverse speed limit that is used during Autotune. 70 % P27 [Motor NP Hertz] minimum.
Encoder Module Parameter (Port X)	Setting
P10 [R00 Sel]	Port 0, P935 [Drive Status 1], Bit 1 "Active"

2. Press the Start button on the Control Bar.

When the Rotate Tune routine is complete, P70 [Autotune] changes to 0 "Ready."

Check tuning results in P73 [IR Voltage Drop], P74 Ixo Voltage Drop], and P75 [Flux Current Ref].

## Inertia Tune

The Inertia Tune routine measures the time to accelerate the system (with load) by using P71 [Autotune Torque] to the nominal speed. The test speed can be limited by reducing P520 [Max Fwd Speed] and P521 [Max Rev Speed]. The fastest test is achieved with P71 [Autotune Torque] set to a high value and P520 [Max Fwd Speed] and P521 [Max Rev Speed] set to a low value.

Because loads vary in crane applications, the result of an Inertia Tune is more or less irrelevant as it is for one condition only.

[Step 8](#) outlines manually setting tuning values.

**IMPORTANT** Ensure that the Inertia Tune routine can be stopped if an end travel condition is likely to occur.

1. Enter Inertia Tune parameter settings.

Drive Parameter	Setting
P70 [Autotune]	4 "Inertia Tune"

2. Press the Start button on the Control Bar.

When the Rotate Tune routine is complete, P70 [Autotune] changes to 0 "Ready."

Check tuning results in P76 [Total Inertia].

When using an encoder, the drive and motor can hold zero speed with full load even with an opened mechanical brake.

## 3. Set minimum speed.

Drive Parameter	Setting
P522 [Min Fwd Speed]	0.00
P523 [Min Rev Speed]	0.00

## 4. Set maximum speed limits.

Drive Parameter	Setting
P520 [Max Fwd Speed]	Forward speed limit that is used during normal operation. Not more than the motor nominal frequency.
P521 [Max Rev Speed]	Reverse speed limit that is used during normal operation. Not more than the motor nominal frequency.

## 5. Set digital input functions.

## Speed Select Inputs

Drive Parameter	Setting
P173...175 [DI Speed Sel <i>n</i> ]	I/O Port Number, P1 [Dig In Sts], Bit <i>n</i>

## Clear Fault Input

Drive Parameter	Setting
P156 [DI Clear Fault]	I/O Port Number, P1 [Dig In Sts], Bit <i>n</i>

## 6. Set speed reference.

Program preset speeds according to Speed Select inputs that are used.

Input Status (1 = Input Actuated)			Auto Reference Source
DI Speed Sel 2	DI Speed Sel 1	DI Speed Sel 0	
0	0	0	Reference A
0	0	1	Reference A
0	1	0	Reference B
0	1	1	Preset Speed 3
1	0	0	Preset Speed 4
1	0	1	Preset Speed 5
1	1	0	Preset Speed 6
1	1	1	Preset Speed 7

I/O Module Parameter (Port X)	Setting
P10 [R00 Sel]	Port 0, P935 [Drive Status 1], Bit 16 "Running"

## 7. Run crane with crane control unit.

Verify speed references by checking P930 [Speed Ref Source].

## 8. Set speed loop tuning.

Drive Parameter	Setting
P636 [Speed Reg BW]	20 R/S Defines the reactivity of the speed regulator. This parameter is used to calculate Kp and Ki gains.
P76 [Total Inertia]	1.5 Secs This value can be increased or decreased depending on Speed regulator response.

$$P645 \text{ [Speed Reg Kp]} = P636 \text{ [Speed Reg BW]} \times P76 \text{ [Total Inertia]} = \text{BW} \times J \text{ (Inertia)}$$

## Torque Prove

Carefully perform the following steps in the order presented.

1. Enter Torque Prove parameter settings.

I/O Module Parameter (Port X)	Setting
P10 [R00 Sel]	0.00 (Disabled)
P6 [Dig Out Invert]	Bit 0 "Relay Out 0" = 1 (Output Inverted)
P10 [R00 Sel]	Port 0, P1103 [Trq Prove Status], Bit 4 "Brake Set" = 1
Drive Parameter	Setting
P1100 [Trq Prove Cfg]	Bit 0 "TP Enable" = 1

Once Torque Prove is activated, the drive is in alarm state.

2. Select the source of position feedback.

Drive Parameter	Setting
P135 [Psn Fdbk Sel]	Encoder Port Number, P4 [Enc 0 FB]

3. Set the time to decrease motor torque during Brake Slip test.

Drive Parameter	Setting
P1104 [Trq Lmt SlewRate]	10.000 Secs (Default)

4. Set speed deviation.

Drive Parameter	Setting
P1105 [Speed Dev Band]	Start with default Hz or RPM.

Increase this setting if the drive faults on F20 [TorqPrv Spd Band].

5. Set speed deviation level.

Drive Parameter	Setting
P1106 [SpdBand Intgrtr]	0.060 Secs (Default)

Increase this setting if the drive faults on F20 [TorqPrv Spd Band].

6. Set brake release time.

Drive Parameter	Setting
P1107 [Brk Release Time]	0.100 Secs (Default)

Increase or decrease this setting depending on the time that is required to open the brake.

7. Set brake set time.

Drive Parameter	Setting
P1108 [Brk Set Time]	0.100 Secs (Default)

Increase or decrease this setting depending on the time that is required to close the brake.

8. Set allowable brake slip.

Drive Parameter	Setting
P1109 [Brk Alarm Travel]	1.00 (Default)

Sets the number of motor revolutions the motor is allowed to lower the load when a brake slip has been detected.



**9.** Set brake slip definition.

Drive Parameter	Setting
P1110 [Brk Slip Count]	250.00 (Default)

Sets the number of encoder counts to define a brake slippage condition.  
 Counts = Encoder PPR x 4

**10.** Set brake float tolerance.

Drive Parameter	Setting
P1111 [Float Tolerance]	Use default Hz or RPM.

Sets the level at which the float timer starts counting.

**11.** Set brake float time.

Drive Parameter	Setting
P1113 [ZeroSpdFloatTime]	5.000 Secs (Default)

Sets the time to maintain zero speed with brake open when the run command has been released.

*Setup Complete*

The drive is now set up and Torque Prove for the mechanical brake control is activated. The load can now be applied.

DriveObserver™ can be used to optimize the speed loop tuning. Use a 30 second time scaling on the X-axis

**12.** Use DriveObserver to configure the following traces.

Drive Parameter	Setting
P3 [Mtr Vel Fdbk]	Scaled to minimum and maximum speed limits.
P594 [Ramped Spd Ref]	Scaled to minimum and maximum speed limits.
P7 [Output Current]	Scaled to current limit value.
P11 [DC Bus Volts]	Default scaling.
P5 [Torque Cur Fdbk] (Optional)	Default scaling.

Run the crane up and down under full load. If necessary, adjust acceleration and deceleration rates.

## Troubleshooting

The following faults commonly occur during drive commissioning.

### F4 “Undervoltage”

- If the mains supply is still present, reduce the undervoltage level at P461 [UnderVltg Level].

### F5 “Overvoltage”

- Monitor the DC Bus voltage while operating the crane. When lowering the load, limit the DC bus voltage to 750V DC.
- Verify that the external resistor is correctly connected / wired
- Verify that the parameter settings as stated in Point 1.
- Monitor bit 20 DB active of P935 [Drive Status 1]. This bit comes on when dynamic braking is active.

### F20 “TrqProve Spd Band” (Speed deviation fault)

- This fault is only active when TorqProve is enabled.
- Speed loop tuning not correct. Increase P636 [Speed Reg BW] or P76 [Total Inertia]. If values are too high, the regulator becomes unstable.
- Verify P3 [Mtr Vel Fdbk] follows P594 [Ramped Spd Ref] as best as possible.
- Drive is going into current limit. Drive is undersized or acceleration / deceleration are set too fast.
- Brake is not opening. Check for faulty brake rectifier.

For more fault information, see [Chapter 6](#).

## Crane Setup - Encoderless

These setup instructions assume the following.

- Drive and motor size have been carefully selected
- External brake resistor has been properly sized
- The drive is at factory defaults.

If not, unplug the output relay terminal block and issue a reset to factory defaults for the HOST and all PORTS. Plug terminal block back in.

- Programming is done via DriveExecutive or DriveExplorer
- Crane control is done via Run forward / Run Reverse inputs
- Mechanical brake control is wired to Output Relay 0



**ATTENTION:** Loss of control in suspended load applications can cause personal injury and/or equipment damage. The drive or a mechanical brake must always control the loads. Parameters 1100 . . . 1113 are designed for lifting/torque prove applications. It is the responsibility of the engineer and/or end user to configure drive parameters, test any lifting functionality and meet safety requirements in accordance with all applicable codes and standards.

---

## Set Up the Drive

1. Adjust parameter settings and enter nameplate data.

Parameter	Setting
<b>Brake Details</b>	
P370 [Stop Mode A]	1 "Ramp"
P372 [Bus Reg Mode A]	2 "Dyn Brake" (Dynamic Braking)
P382 [DB Resistor Type]	1 "External"
P383 [DB Ext Ohms]	Total Ohm value of external resistor.
P384 [DB Ext Watts]	Total real watt rating of external resistor.
P385 [DB ExtPulseWatts]	Maximum value for properly sized resistor.
P426 [Regen Power Lmt]	-800 % (Minimum Value)
<b>Motor Nameplate Data</b>	
P25 [Motor NP Volts]	Motor nameplate voltage.
P26 [Motor NP Amps]	Motor nameplate current.
P27 [Motor NP Hertz]	Motor nameplate frequency.
P28 [Motor NP RPM]	Motor nameplate speed.
P29 [Mtr NP Pwr Units]	0 "HP" or 1 "kW"
P30 [Motor NP Power]	Motor nameplate power rating.
P31 [Motor Poles]	Number of motor poles.
<b>Motor Control</b>	
P35 [Motor Ctrl Mode]	3 "Induction FV"
<b>Motor Slip</b>	
P621 [Slip RPM at FLA]	Synchronous Speed – P28 [Motor NP RPM] Example: 6 pole – 980 RPM motor Synchronous Speed = (NP frequency x 60 Secs)/pole pairs (50 Hz x 60 Secs) / 3 = 1000 RPM Slip = Synchronous Speed – Motor NP RPM = 1000 – 980 = 20 RPM (enter 20 in P621)
<b>Drive Duty Rating</b>	
P306 [Duty Rating]	1 "Heavy Duty"
<b>Overload Hertz</b>	
P414 [Mtr OL Hertz]	0.00 (Ensures that no current derating is applied.)
<b>Autotune Torque</b>	
P71 [Autotune Torque]	100.00 % (Used during rotate tuning and inertia tuning.)
<b>Protection</b>	
P420 [Drive OL Mode]	1 "Reduce PWM"
P422 [Current Limit 1]	200 % of P26 [Motor NP Amps]
P444 [OutPhaseLossActn]	3 "FltCoastStop"

## Motor Tune Routines

### Static Tune

This routine measures motor characteristics with the brake set (brake closed).

### Rotate Tune

This routine gives better results if connected equipment allows. This routine requires the mechanical brake to open and the motor be allowed to run at minimum of 70 % of nominal speed.

### Inertia Tune


This routine measures the time to accelerate the system to the nominal speed.

## Static Tune

During a Static Tune, the mechanical brake remains set.

1. Enter Static Tune parameter settings.

Drive Parameter	Setting
P70 [Autotune]	2 "Static Tune"
I/O Module Parameter (Port X)	Setting
P10 [ROO Sel]	0.00 "Disabled"

2. To open the Control Bar, click the Controls icon .
3. Press the Start button on the Control Bar.

When the Static Tune routine is complete, P70 [Autotune] changes to 0 "Ready."

### Verify Drive Direction

1. Perform a Direction Test to verify proper direction of crane.

I/O Module Parameter (Port n)	Setting
P164 [DI Run Forward]	Port Number, P1 [Dig In Sts], Bit n (Run Fwd Input)
P165 [DI Run Reverse]	Port Number, P1 [Dig In Sts], Bit n (Run Rev Input)

---

**IMPORTANT** The crane can be started via the crane control unit.

---

Drive Parameter	Setting
P545 [Spd Ref A Sel]	Port 0, P571 [Preset Speed 1]
P571 [Preset Speed 1]	15 Hz (Set to low speed for direction test.)
P535 [Accel Time 1]	2.00 Secs
P537 [Decel Time 1]	2.00 Secs
I/O Module Parameter (Port X)	Setting
P10 [ROO Sel]	Port 0, P935 [Drive Status 1], Bit 16 "Running"

---

**IMPORTANT** The mechanical brake opens when the drive is running.

---

2. Run crane with the crane control unit and verify that the direction is correct.

If crane direction is not correct, change motor direction.

Drive Parameter	Setting
P40 [Mtr Options Cfg]	Bit 4 "Mtr Lead Rev" = 1 (Reversed)

Run crane with the crane control unit and verify that the direction is now correct.

Move crane hook to a position that allows sufficient travel in both directions.

## Rotate Tune

During a Rotate Tune routine, the motor runs for 20 seconds in the commanded direction. The Rotate Tune routine must be executed in a no load or lightly loaded condition such as the motor connected to a gearbox, cable drum, or cable and hook.

---

**IMPORTANT** Ensure that the Rotate Tune routine can be stopped if an end travel condition is likely to occur.

---

If the motor is connected to a load, determine whether there is enough travel distance for the Rotate Tune sequence to complete. If necessary, run the crane hook to top or bottom for more travel distance in the opposite direction.

If the Rotate Tune routine fails due to motor load, rerun the Static Tune routine and skip this routine.

1. Enter Rotate Tune parameter settings.

Drive Parameter	Setting
P70 [Autotune]	3 "Rotate Tune"
P520 [Max Fwd Speed]	Forward speed limit that is used during Autotune. 70 % P27 [Motor NP Hertz] minimum.
P521 [Max Rev Speed]	Reverse speed limit that is used during Autotune. 70 % P27 [Motor NP Hertz] minimum.
Encoder Module Parameter (Port X)	Setting
P10 [R00 Sel]	Port 0, P935 [Drive Status 1], Bit 1 "Active"

2. Press the Start button on the Control Bar.

When the Rotate Tune routine is complete, P70 [Autotune] changes to 0 "Ready."

Check tuning results in P73 [IR Voltage Drop], P74 Ixo Voltage Drop], and P75 [Flux Current Ref].

## Inertia Tune

The Inertia Tune routine measures the time to accelerate the system (with load) by using P71 [Autotune Torque] to the nominal speed. The test speed can be limited by reducing P520 [Max Fwd Speed] and P521 [Max Rev Speed]. The fastest test is achieved with P71 [Autotune Torque] set to a high value and P520 [Max Fwd Speed] and P521 [Max Rev Speed] set to a low value.

Because loads vary in crane applications, the result of an Inertia Tune is more or less irrelevant as it is for one condition only.

[Step 8](#) outlines manually setting tuning values.

---

**IMPORTANT** Ensure that the Inertia Tune routine can be stopped if an end travel condition is likely to occur.

---

1. Enter Inertia Tune parameter settings.

Drive Parameter	Setting
P70 [Autotune]	4 "Inertia Tune"

2. Press the Start button on the Control Bar.

When the Rotate Tune routine is complete, P70 [Autotune] changes to 0 "Ready."

Check tuning results in P76 [Total Inertia].

3. Set minimum speed.

Drive Parameter	Setting
P522 [Min Fwd Speed]	2 x Slip Frequency of Motor. (From motor nameplate.)
P523 [Min Rev Speed]	2 x Slip Frequency of Motor. (From motor nameplate.)

4. Set maximum speed limits.

Drive Parameter	Setting
P520 [Max Fwd Speed]	Forward speed limit that is used during normal operation. Not more than the motor nominal frequency.
P521 [Max Rev Speed]	Reverse speed limit that is used during normal operation. Not more than the motor nominal frequency.

5. Set digital input functions.

### Speed Select Inputs

Drive Parameter	Setting
P173...175 [DI Speed Sel <i>n</i> ]	I/O Port Number, P1 [Dig In Sts], Bit <i>n</i>

### Clear Fault Input

Drive Parameter	Setting
P156 [DI Clear Fault]	I/O Port Number, P1 [Dig In Sts], Bit <i>n</i>

6. Set speed reference.

Program preset speeds according to Speed Select inputs that are used.

Input Status (1 = Input Actuated)			Auto Reference Source
DI Speed Sel 2	DI Speed Sel 1	DI Speed Sel 0	
0	0	0	Reference A
0	0	1	Reference A
0	1	0	Reference B
0	1	1	Preset Speed 3
1	0	0	Preset Speed 4
1	0	1	Preset Speed 5
1	1	0	Preset Speed 6
1	1	1	Preset Speed 7

I/O Module Parameter (Port X)	Setting
P10 [R00 Sel]	Port 0, P935 [Drive Status 1], Bit 16 "Running"

7. Run crane with crane control unit.

Verify speed references by checking P930 [Speed Ref Source].

8. Set speed loop tuning.

Drive Parameter	Setting
P636 [Speed Reg BW]	20 R/S Defines the reactivity of the speed regulator. This parameter is used to calculate Kp and Ki gains.
P76 [Total Inertia]	1.5 Secs This value can be increased or decreased depending on Speed regulator response.

$$P645 \text{ [Speed Reg Kp]} = P636 \text{ [Speed Reg BW]} \times P76 \text{ [Total Inertia]} = \text{BW} \times J \text{ (Inertia)}$$



## Torque Prove

Carefully perform the following steps in the order presented.

1. Enter Torque Prove parameter settings.

I/O Module Parameter (Port X)	Setting
P10 [R00 Sel]	0.00 (Disabled)
P6 [Dig Out Invert]	Bit 0 "Relay Out 0" = 1 (Output Inverted)
P10 [R00 Sel]	Port 0, P1103 [Trq Prove Status], Bit 4 "Brake Set" = 1
Drive Parameter	Setting
P1100 [Trq Prove Cfg]	Bit 0 "TP Enable" = 1 Bit 1 "Encoderless" = 1 Bit 5 "BrkSlipEncls" = 1

---

**IMPORTANT** After Torque Prove is activated, the drive is in an alarm state as described on [page 372](#). Carefully read the Attention statement and acknowledge it by setting the required parameter.

---

2. Set speed deviation.

Drive Parameter	Setting
P1105 [Speed Dev Band]	10 Hz

This setting can be lowered once the system has been tuned. The lower this value, the faster the protection.

3. Set speed deviation level.

Drive Parameter	Setting
P1106 [SpdBand Intgrtr]	0.200 Secs (Default)

This setting can be lowered once the system has been tuned. The lower this value, the faster the protection.

4. Set brake float tolerance.

Drive Parameter	Setting
P1111 [Float Tolerance]	2...3 times Slip Frequency of Motor.

Sets the level where the mechanical brake sets in encoderless mode.

### Setup Complete

The drive is now set up and Torque Prove for the mechanical brake control is activated. The load can now be applied.

DriveObserver can be used to optimize the speed loop tuning. Use a 30 second time scaling on the X-axis

5. Use DriveObserver to configure the following traces.

Drive Parameter	Setting
P3 [Mtr Vel Fdbk]	Scaled to minimum and maximum speed limits.
P594 [Ramped Spd Ref]	Scaled to minimum and maximum speed limits.
P7 [Output Current]	Scaled to current limit value.
P11 [DC Bus Volts]	Default scaling.
P5 [Torque Cur Fdbk] (Optional)	Default scaling.

Run the crane up and down under full load. Adjust acceleration and deceleration rates if necessary.

## Troubleshooting

The following faults commonly occur during drive commissioning.

### F4 “Undervoltage”

- If the mains supply is still present, reduce the undervoltage level at P461 [UnderVltg Level].

### F5 “Overvoltage”

- Monitor the DC Bus voltage while operating the crane. When lowering the load, limit the DC bus voltage to 750V DC.
- Verify that the external resistor is correctly connected / wired
- Verify that the parameter settings as stated in Point 1.
- Monitor bit 20 DB active of P935 [Drive Status 1]. This bit comes on when dynamic braking is active.

### F20 “TrqProve Spd Band” (Speed deviation fault)

- This fault is only active when TorqProve is enabled.
- Speed loop tuning not correct. Increase P636 [Speed Reg BW] or P76 [Total Inertia]. If values are too high, the regulator becomes unstable.
- Verify that P3 [Mtr Vel Fdbk] follows P594 [Ramped Spd Ref] as best as possible.
- Drive is going into current limit. Drive is undersized or acceleration / deceleration are set too fast.
- Brake is not opening. Check for faulty brake rectifier.

For more fault information, see [Chapter 6](#).

## Pump Off Function

### Overview

The Pump Off function is used to change the speed of or stop the pump jack automatically, based on torque feedback from the motor. This function is useful for maximizing well production and reducing mechanical wear.

Configure P1187 [Pump Off Config] in one of two ways to detect a Pump Off.

- Down Stroke Torque method: Setting 0 “Automatic” or 1 “Position”  
The pump jack down stroke torque is based on a detected waveform.
- Cycle Torque method: Setting 2 “Cycle”  
The pump jack down stroke torque is based on a full pump stroke cycle.

### Setup

To use the Pump Off feature, the drive must operate in flux vector (FV) control mode. This mode requires that you enter motor nameplate data and complete a motor autotune routine. Gearbox ratio and sheave size data are also required.

Pump off control can be set to use a torque baseline, which is created when the drive is first run or from a fixed set point. The fixed set point is useful if the drive cannot detect a signature waveform due to well conditions. The drive does not create a set point that is based on what could be a pump off condition.

The down stroke torque can change position on some wells due to slippage in the system. In these cases, the peaks and valleys of the torque waveform move enough that the position reconnect does not work properly. This slippage can be seen on the position test point in that the position continues to reset early. To work on these pumps, the torque waveform over one cycle is averaged.

## Gather Motor and Pump Data

Complete the table with the motor nameplate and pump data listed.

### Motor Data

Motor Nameplate Volts		V
Motor Nameplate FLA		A
Motor Nameplate Hertz		Hz
Motor Nameplate RPM		RPM
Motor Nameplate Power		Hp
Motor Poles		Pole

### Pump Data

Gearbox Sheave Diameter		in.
Gearbox Ratio		:
Gearbox Rating		kin#
Motor Sheave Diameter		in.

## Enter Motor Data

Enter the motor data from above and adjust parameter settings.

Parameter	Setting
<b>Parameter Access Level</b>	
P301 [Access Level]	2 "Expert"
<b>Motor Nameplate Data</b>	
P25 [Motor NP Volts]	Motor nameplate voltage.
P26 [Motor NP Amps]	Motor nameplate current.
P27 [Motor NP Hertz]	Motor nameplate frequency.
P28 [Motor NP RPM]	Motor nameplate speed.
P29 [Mtr NP Pwr Units]	0 "HP" or 1 "kW"
P30 [Motor NP Power]	Motor nameplate power rating.
P31 [Motor Poles]	Number of motor poles.
<b>Motor Control</b>	
P35 [Motor Ctrl Mode]	3 "Induction FV"

## Run Motor Tune Routine

The drive can be tuned to the motor. Autotune routines can be accessed directly or through the Start Up menu.

When tuning, it is preferred that the motor is uncoupled from the pump jack and a Rotate Tune routine be performed. If this action is not possible, perform a Static Tune routine.



**ATTENTION:** Rotation of the motor in an undesired direction can occur during this procedure. To guard against possible injury and/or equipment damage, it is recommended to disconnect the motor from the load before proceeding.

### Access Autotune Directly

1. Verify that the motor is turning in the forward direction by jogging the motor. Face the motor shaft and verify clockwise rotation. If necessary, correct the direction of rotation by using one of the following methods.
  - a. Swap any two motor leads. This method is recommended to help avoid confusion later.
  - b. Change the motor direction by configuring drive firmware.

Drive Parameter	Setting
P40 [Mtr Options Cfg]	Bit 4 "Mtr Lead Rev" = 1 (Reversed)


2. Once direction is established, enter the Rotate Tune parameter setting.

Drive Parameter	Setting
P70 [Autotune]	3 "Rotate Tune"

3. Press Start and allow the drive to complete the Autotune routine.

When complete, the motor can now be coupled to the pump jack.

### Access Autotune Through Start Up Menu

1. On the Human Interface Module (HIM), press the  (Folders) key to navigate to the Start Up tab.
2. Select General Startup and answer the questions when prompted.

When complete, the motor can be coupled to the pump jack.

## Enter Pump Data

Enter pump data and adjust parameter settings.

Parameter	Setting
<b>Pump Jack</b>	
P1178 [Motor Sheave]	Diameter in inches.
P1179 [OilWell Pump Cfg]	1 "Pump Jack"
P1181 [Gearbox Limit]	Percent of P1182 [Gearbox Rating]
P1182 [Gearbox Rating]	Nameplate gearbox rating.
P1183 [Gearbox Ratio]	Nameplate gear ratio.
P1184 [Gearbox Sheave]	Diameter in inches.
<b>Pump Off</b>	
P1187 [Pump Off Config]	0 "Automatic" (Default)
P1189 [Pump Off Action]	Select preferred action.
P1190 [Pump Off Control]	0 "Disable" (Default)

## Enter Desired Bus Regulation Data

The following parameter settings assume that a dynamic brake resistor is used.

Parameter	Setting
<b>Brake Features</b>	
P372 [Bus Reg Mode A]	2 "Dyn Brake" <sup>(1)</sup>
P382 [DB Resistor Type]	1 "External"
P383 [DB Ext Ohms]	Based on performance preference.
P384 [DB Ext Watts]	Based on performance preference.
P385 [DB ExtPulseWatts]	Based on performance preference.
<b>Motor Overload</b>	
P409 [Dec Inhibit Actn]	0 "Ignore"
<b>Load Limits</b>	
P426 [Regen Power Lmt]	Set to match the value that is calculated for P671 [Neg Torque Limit], see below this table.

(1) If no dynamic braking resistor is used, set P372 [Bus Reg Mode A] to 1 "Adjust Freq" (Default). Speed is sacrificed for bus regulation and P524 [Overspeed Limit] must be adjusted.



**ATTENTION:** The “adjust freq” portion of the bus regulator function is extremely useful for preventing nuisance overvoltage faults resulting from aggressive decelerations, overhauling loads, and eccentric loads. It forces the output frequency to be greater than commanded frequency while the drive’s bus voltage is increasing towards levels that would otherwise cause a fault. However, it can also cause either of the following two conditions to occur.

1. Fast positive changes in input voltage (more than a 10% increase within 6 minutes) can cause uncommanded positive speed changes. However an “OverSpeed Limit” fault occurs if the speed reaches [Max Speed] + [Overspeed Limit]. If this condition is unacceptable, take action to 1) limit supply voltages within the specification of the drive and, 2) limit fast positive input voltage changes to less than 10%. If this operation is unacceptable and the necessary actions cannot be taken, the “adjust freq” portion of the bus regulator function must be disabled (see parameters 372 and 373).
2. Actual deceleration times can be longer than commanded deceleration times. However, a “Decel Inhibit” fault is generated if the drive stops decelerating altogether. If this condition is unacceptable, the “adjust freq” portion of the bus regulator must be disabled (see parameters 372 and 373). In addition, installing a properly sized dynamic brake resistor provides equal or better performance in most cases. Important: These faults are not instantaneous. Test results have shown that they can take between 2...12 seconds to occur.

The following positive and negative torque limits are calculated on powerup and entered by the drive.

- P670 [Pos Torque Limit] is calculated using the motor parameters.
- P671 [Neg Torque Limit] is calculated using the dynamic-brake resistor ohmic value and rated torque of the motor. If a dynamic brake resistor is not used, the default negative torque limit is used.

Change P426 [Regen Power Lmt] to match the value in P671 [Neg Torque Limit] to maximize dynamic brake performance.

## Store Pump Cycle Torque

1. Verify the well is full.
2. Enter a command speed.
3. Start the Pump Jack from the HIM.
4. Set P1192 [Pump Cycle Store] to option 1 “Enable.”

If the Pump Off feature detects a pump jack torque-signature waveform, the waveform is stored and the parameter resets to 0 “Disabled.”

If this parameter does not reset to 0 “Disabled,” set P1187 [Pump Off Config] to option 2 “Cycle.” In Cycle mode, the entire cycle torque is used as the down-stroke torque used in the original pump off detection. There is no need to set the top of stroke in this mode.

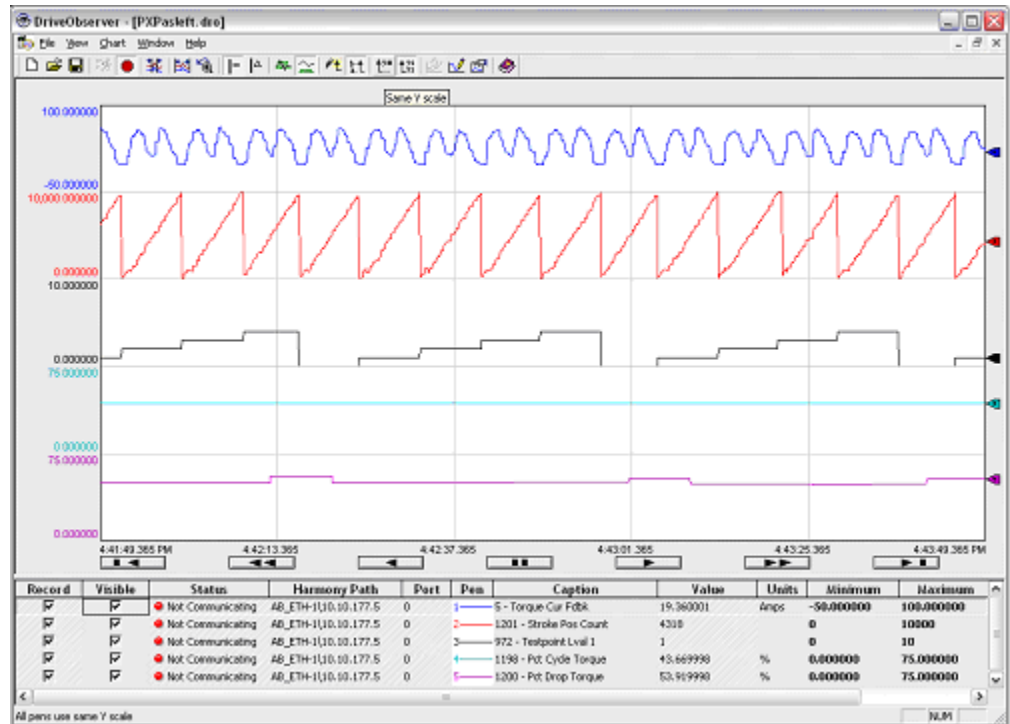
## Initialize Pump Stroke Position

1. Set P1193 [Set Top of Stroke] to option 1 “Enable.”

Use a Human Interface Module (HIM) to avoid any communication delays.

2. Press enter when you visually see the Horsehead at the top position. This action sets the stroke position to the stored pump cycle torque.
3. Stop the drive.
4. Configure DriveObserver with the following parameters.
  - P5 [Torque Cur Fdbk]
  - P972 [Testpoint Lval]
  - P1198 [Pct Cycle Torque]
  - P1200 [Pct Drop Torque]
  - P1201 [Stroke Pos Count]



**Figure 80 - DriveObserver Settings**

The value of P970 [Testpoint Sel 1] is referenced from P972 [Testpoint Lval 1].

- Set P970 [Testpoint Sel 1] to a cycle count of 2043.

## Initialize the Pump Off Feature

- Set P1190 [Pump Off Control] to option 1 “Baseline Set.”
- With the well full, start the drive.

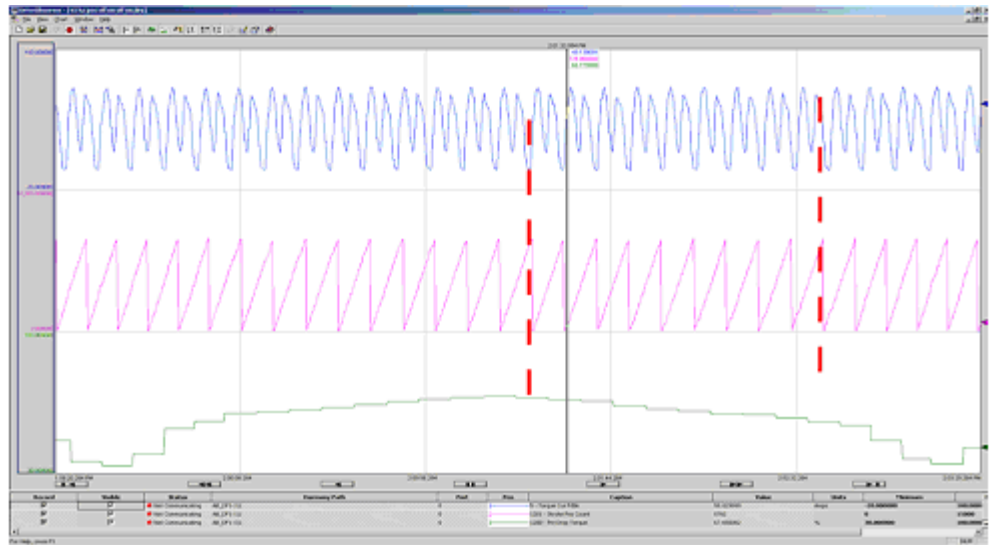
You can see waveforms similar to the waveforms in [Figure 80](#). Monitor the Pump Jack and verify the Pump Off Action.

## Fine-Tuning

P1195 [Pump Off Level], P1196 [Pump Off Speed], and P1197 [Pump Off Time] all contribute to the productivity of the well and must be adjusted. For more information read the parameter descriptions in [Chapter 3](#).

Occasionally the position starts to drift relative to the torque signature. If drift occurs, set P1188 [Pump Off Setup] Bit 1 “Pos Offset” to 1. See [Figure 81](#) for an example of what this drift would look like.

**Figure 81 - Correcting Drift**



Notice how the position has drifted relative to the torque. This drift causes the incorrect part of the waveform to be averaged as the down stroke torque and results in a false pump off condition. The drift can be corrected by setting the position offset bits properly.

## Sleep Mode

If P1189 [Pump Off Action] is set to 1 “Always Stop,” 2 “Stop After 1,” or 3 “Stop After 2,” the Sleep Wake function must be configured. Set the following parameters.

Parameter	Setting
<b>Start Features</b>	
P350 [Sleep Wake Mode]	1 “Direct” (Enabled)
P351 [SleepWake RefSel]	1207 (Entered through the Numeric Edit tab.)
P355 [Wake Time]	Desired restart time (64800 seconds maximum).

## Pump Off Control Outlines

### *Automatic/Position Baseline Set*

The following steps are a general outline of how the initial Pump Off control is configured in the PowerFlex 753. The default configuration uses the down stroke torque with P1187 [Pump Off Config] set to 0 “Automatic” or 1 “Position” and P1190 [Pump Off Control] set to 1 “Baseline Set.”

### Set Base Speed Command

A commanded speed setting is chosen based on well characteristics, which produces the desired pump performance, most of the time. Pump off control is then configured to maintain acceptable pump performance when conditions temporarily change.

1. Pump off control requires the drive to be “At Speed.” Check P935 [Drive Status 1] Bit 8 to verify this operating condition.
2. When P935 [Drive Status 1] Bit 8 “At Speed” = 1, the internal pump jack at speed bit is set and the current speed command is saved.
3. The next ten down stroke torques are sampled and summed.
4. The average of the down stroke torques is saved as the baseline for the current speed.
5. P1191 [Pump Off Status] Bit 6 “Pump Stable” = 1.

When Bit 6 = 0, the drive is averaging a new baseline torque.

6. The pump jack is running under normal conditions.
7. While running under normal conditions, every fifth stroke is compared against the baseline to check for a pump off condition. The stroke count can be monitored in test point TP 2043.

### Change in Cycle Torque

If the cycle torque sample is less than or greater than the fixed setpoint by the percentage set in P1195 [Pump Off Level], the following occurs:

- P1191 [Pump Off Status] Bit 5 “PumpOff Alarm” = 1
- The drive waits for a second sample

If the second sample is also less than or greater than the fixed setpoint by the percentage set in P1195 [Pump Off Level], a Pump Off condition is detected.

### Run At Reduced Speed

When a Pump Off condition exists, and P1189 [Pump Off Action] is set to 0 “Change Speed,” the percentage set in P1196 [Pump Off Speed] lowers the commanded speed.

$$\text{Reduced Speed} = \text{Commanded Speed} - (\text{Commanded Speed} \times P1196)$$

8. When the reduced speed is reached, P935 [Drive Status 1] Bit 8 “At Speed” = 1, the next ten down stroke torques are sampled and summed.
9. The average of the down stroke torques is saved as the baseline for the new speed. P1191 [Pump Off Status] Bit 6 “Pump Stable” is reset.
10. The pump jack runs at the reduced speed for the length of time set in P1197 [Pump Off Time] then the pump jack resumes pumping at the base speed command. ([Step 6](#) in this sequence.)

If P1189 [Pump Off Action] is set to 3 “Stop After 2,” go to [Step 11](#).

Whenever the operator changes the base speed command, the process starts over at [Step 1](#) in this sequence. This action does not apply to speed changes that are triggered by P1189 [Pump Off Action] when a pump off condition is detected.

11. While running at the first reduced Pump Off Speed, every fifth stroke is compared to the new baseline for a pump off condition.

If the down-stroke torque samples remain stable during the time set in P1197 [Pump Off Time], the following occurs:

- Commanded speed returns to the original base speed
- Down stroke torque samples are compared against the original baseline. ([Step 6](#) in this sequence.)

If two down stroke torque samples are less than or greater than the new baseline by the percentage set in P1195 [Pump Off Level], the following occurs:

- The Pump Off condition persists
- The percentage set in P1196 [Pump Off Speed] lowers the commanded speed a second time.

12. When the second reduced speed is reached, P935 [Drive Status 1] Bit 8 “At Speed” = 1, the next ten down stroke torques are sampled and summed.
13. The average of the down stroke torques is saved as the baseline for the second new speed. P1191 [Pump Off Status] Bit 6 “Pump Stable” is reset.
14. The pump jack runs at the second reduced speed for the length of time set in P1197 [Pump Off Time] and resumes pumping at the base speed command. ([Step 6](#) in this sequence.)

- 15.** While running at the second reduced Pump Off Speed, every fifth stroke is compared to the second new baseline for a persistent pump off condition.

If the down-stroke torque samples remain stable during the time set in P1197 [Pump Off Time], the following occurs:

- The commanded speed returns to the original base speed
- The down stroke torque samples are compared against the original baseline. ([Step 6](#) in this sequence.)

If two down stroke samples are less than or greater than the second new baseline by the percentage set in P1195 [Pump Off Level], the following occurs:

- The Pump Off condition persists
- The drive stops for the length of time set in P353 [Sleep Time]

- 16.** When P353 [Sleep Time] expires, the pump jack restarts and runs under normal conditions. ([Step 6](#) in this sequence.)

When P1189 [Pump Off Action] is set to 2 “Stop After 1,” the drive stops for the length of time set in P353 [Sleep Time] after one reduction of speed. ([Step 11](#) in this sequence.)

When P1189 [Pump Off Action] is set to 1 “Always Stop,” the drive stops for the length of time set in P353 [Sleep Time] at the first detection of a Pump Off condition. When P353 [Sleep Time] expires, the pump jack restarts and runs under normal conditions. ([Step 6](#) in this sequence.)

When P1192 [Pump Cycle Store] does not change back to 0 “disable,” the drive has not been able to detect a pump-jack torque signature waveform to use as a baseline. A fixed set point is required to run the well. See the next section.

### *Cycle Torque Data Fixed Setpoint*

The following is a general outline of how the initial Pump Off control is configured in the PowerFlex 753. This configuration uses cycle torque data with P1187 [Pump Off Config] set to 2 “Cycle” and P1190 [Pump Off Control] set to 2 “Fixed Setpt.”

- 1.** Pump off control requires the drive to be “At Speed.” Check P935 [Drive Status 1] Bit 8 to verify this operating condition.
- 2.** When P935 [Drive Status 1] Bit 8 “At Speed” = 1, the internal pump jack at speed bit is set and the current speed command is saved. The At Speed bit is no longer scrutinized until the speed command is changed or the drive is stopped.

The next three strokes are used to allow the pump to settle out.

- 3.** P1191 [Pump Off Status] Bit 6 “Pump Stable” = 1.
- 4.** The pump jack is running under normal conditions.

5. While running under normal conditions, every fifth stroke is compared against the baseline to check for a pump off condition.

### Change in Down Stroke Torque

If the down-stroke torque sample is less than or greater than the baseline by the percentage set in P1195 [Pump Off Level], the following occurs:

- P1191 [Pump Off Status] Bit 5 “PumpOff Alarm”= 1
- The drive waits for a second sample

If the second sample is also less than or greater than the baseline by the percentage set in P1195 [Pump Off Level], a Pump Off condition is detected.

### Execute Pump Off Action

When a Pump Off condition exists, the drive follows the setting of P1189 [Pump Off Action]. The process starts over at [Step 1](#) in this sequence and five strokes occur to allow the pump to settle out.

Whenever the operator changes the base speed command, the process starts over at [Step 1](#) in this sequence.

When P1187 [Pump Off Config] is set to 2 “Cycle,” the full stroke torque is used for pump off detection. A separate position counter is enabled, which uses the gear ratio and speed feedback to create a position. The gear ratio must be set correctly for this action to work.

- The position increments every 2 ms based on output frequency. The torque is added to a buffer and a counter increments.
- When the position counter reaches 10,000, the counter is reset to 0. The torque buffer is divided by the counter to create the average torque for the cycle.
- This torque is the full cycle torque and is then used as the down stroke torque was used in baseline set detection.

**Table 24 - PowerFlex 753 Pump Off Test Points**

Test Point	Description
TP 2031	Motor Torque in Pump Off
TP 2032	Top Of Stroke in Pump Off
TP 2033	POSITION1 in Pump Off
TP 2034	POSITION2 in Pump Off
TP 2035	POSITION3 in Pump Off
TP 2036	POSITION4 in Pump Off
TP 2037	POSITION5 in Pump Off
TP 2038	Active Position in Pump Off
TP 2039	Position State in Pump Off
TP 2040	Heavily filter torque for position detection in Pump Off
TP 2041	PumpJack control state in Pump Off

<b>Test Point</b>	<b>Description</b>
TP 2042	Avg Torque used for control state in Pump Off
TP 2043	Cycle count in Pump Off
TP 2044	Alarm count in Pump Off
TP 2045	Peak Torque in Pump Off
TP 2046	Offset Position in Pump Off
TP 2047	Simulator Torque Ref
TP 2048	Minimum Torque Position
TP 2049	Active Pump Off level
TP 2050	Down Stroke Torque Integrator
TP 2051	Full Stroke Position for cycle mode
TP 2052	Adjustment to Position indicator

**Table 25 - Parameter List**

<b>No.</b>	<b>Display Name</b>
<a href="#">1187</a>	Pump Off Config
<a href="#">1188</a>	Pump Off Setup
<a href="#">1189</a>	Pump Off Action
<a href="#">1190</a>	Pump Off Control
<a href="#">1191</a>	Pump Off Status
<a href="#">1192</a>	Pump Cycle Store
<a href="#">1193</a>	Set Top ofStroke
<a href="#">1194</a>	Torque Setpoint
<a href="#">1195</a>	Pump Off Level
<a href="#">1196</a>	Pump Off Speed
<a href="#">1197</a>	Pump Off Time
<a href="#">1198</a>	Pct Cycle Torque
<a href="#">1199</a>	Pct Lift Torque
<a href="#">1200</a>	Pct Drop Torque
<a href="#">1201</a>	Stroke Pos Count
<a href="#">1202</a>	Stroke Per Min
<a href="#">1203</a>	Pump Off Count
<a href="#">1204</a>	PumpOff SleepCnt
<a href="#">1205</a>	Day Stroke Count

## Predictive Maintenance with Logix

The PowerFlex 753 and 755 drives contain algorithms for Predictive Maintenance that are used to improve the “up-time” of machines, processes, and facilities. These algorithms monitor the lifespan of certain components. They can be used to alert personnel when the components are nearing the end of their lifespan so the components can be replaced before they fail.

There are algorithms for drive fans, relay contacts on digital outputs, motor bearings, motor lubrication, machine bearings, and machine lubrication. See the Predictive Maintenance group in the Protection folder starting on [page 109](#) for more information.

### Predictive Maintenance for Wall Mount Drives (Frames 1...7)

Predictive maintenance for wall mount drives is straightforward. Each predictive maintenance item has five key parameters: Total Life, Elapsed Life, Remaining Life, Event Level, and Event Action.

- **[Total Life]** is the total expected life of the component
- **[Elapsed Life]** is the amount of life that has been expended
- **[Remaining Life]** is the Total Life minus Elapsed Life
- **[Event Level]** is the amount of Elapsed Time (in percent of Total Life) when you want the drive to warn the user of an impending failure
- **[Event Action]** is the action set to take place when the drive reaches the Event Level. It can be set to the following options: Ignore, Alarm, Fault Minor, Fault Coast Stop, Fault Ramp Stop, or Fault Current Limit Stop.

The alarm and fault actions stop the drive or prevent it from starting. If using a controller and a network interface such as EtherNet/IP, the logic and notification can be handled at the controller level. Configure the [Event Action] parameter to “Ignore” and use the controller to monitor the [Remaining Life] parameter. When the [Remaining Life] parameter reaches the [Event Level] parameter value, the controller sends a message that alerts the user on the HMI (example, PanelView™ or FactoryTalk® View).

On wall mount drives, write explicit messages that read the [Remaining Life] parameter. Write the logic that compares the [Remaining Life] parameter to the [Event Level] parameter. The logic triggers a message when the [Event Level] parameter is reached.

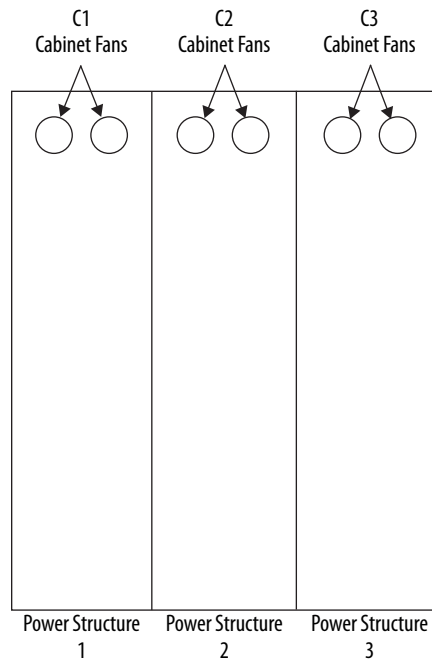


## Predictive Maintenance for Floor Mount Drives (Frames 8...10)

There can be multiple power structures in parallel on floor mount drives; and therefore, multiple sets of fans, which make the predictive maintenance more complicated than on wall mount drives.

To minimize the number of parameters, the parallel inverters, converters, and precharge units do not have separate [Total Life] and [Remaining Life] parameters. You must calculate the individual [Remaining Life] values in the controller.

A frame 10 drive has three power structures, and three sets of cabinet fans, heatsink fans, and internal stirring fans.



These parameters are available for the cabinet fans.

**Table 26 - Cabinet Fan Parameters**

Node	Parameter No.	Parameter Name	Description
0	482	CBFan TotalLife	Displays the expected lifespan for a cabinet fan.
0	483	CBFan ElpsdLife	Displays the greatest expended life of a cabinet fan.
0	484	CBFan RemainLife	Displays the difference between P482 [CBFan TotalLife] and P483 [CBFan ElpsdLife].
11	138	C1 CBFanElpsdLife	Displays the expended life of the fans on cabinet 1.
11	238	C2 CBFanElpsdLife	Displays the expended life of the fans on cabinet 2.
11	338	C3 CBFanElpsdLife	Displays the expended life of the fans on cabinet 3.

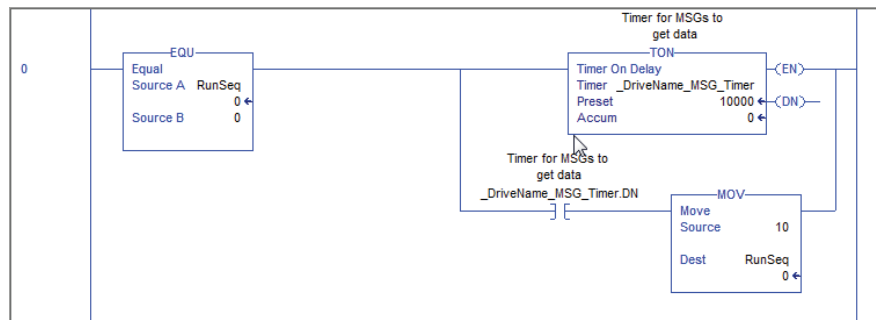
You must calculate the [Remaining Life] parameter values for the cabinet fans in each power structure. This calculation is required anytime the [Elapsed Life] parameter of one power structure differs from another. This difference can occur when one power structure has been replaced or serviced separately from the others.

*Example Code*

This example code calculates the [Remaining Life] value of the cabinet fan for the first power structure. For frames 9 and 10, use similar logic for the other cabinet fans. Use similar logic to calculate the [Remaining Life] of the heatsink fans and the internal stirring fans.

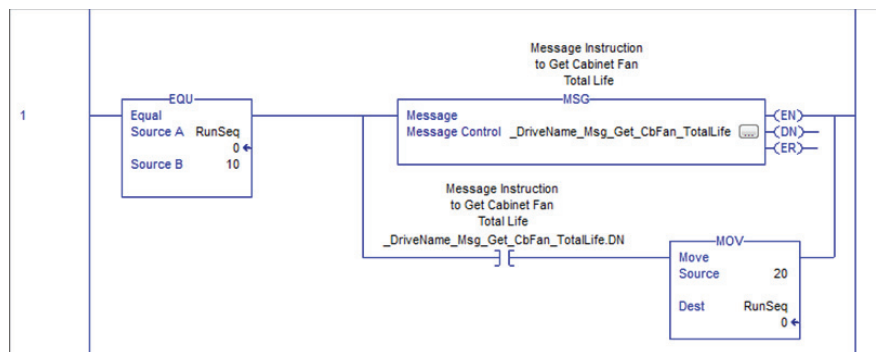
1. Use a timer instruction to set a sensible time interval for reading the data. See [Figure 82](#).

**Figure 82 - Timer Instruction**

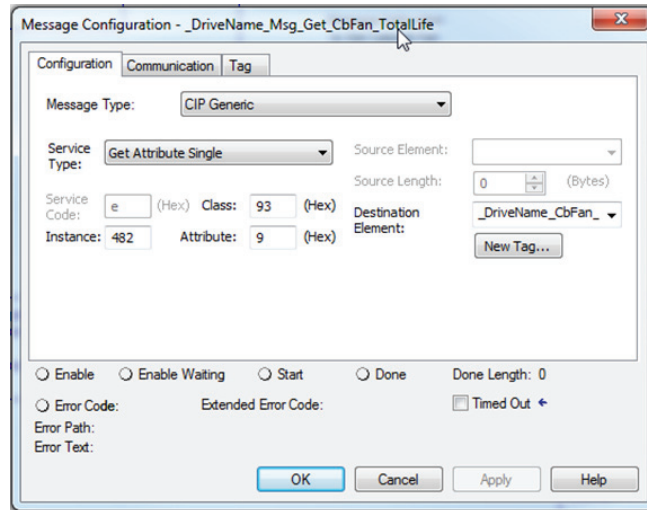


2. Use a message instruction to retrieve the Total Life value. See [Figure 83](#).

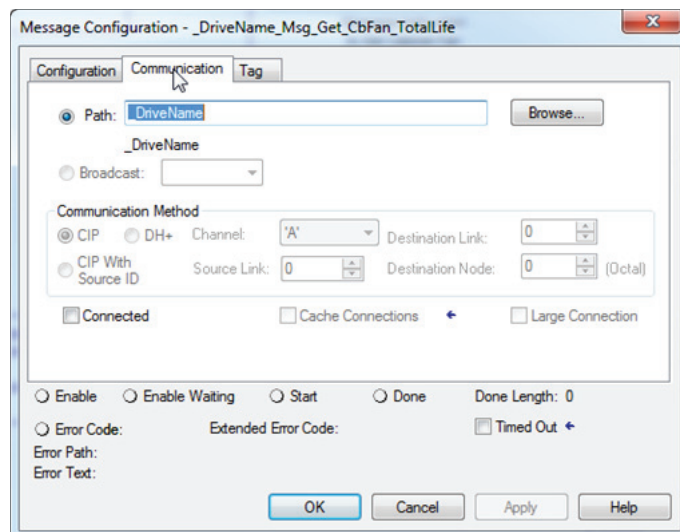
**Figure 83 - MSG Instruction**



3. Configure the message instructions.
  - a. Click the Configuration tab. See [Figure 84](#).

**Figure 84 - Message Configuration Screen - Configuration Tab**

- b. In the Message Type field, click the down arrow to select CIP Generic.
- c. In the Service Type field, click the down arrow to select Get Attribute Single.
- d. In the Class field, enter 93 (hex); use the EtherNet/IP DPI Parameter Object.
- e. Set the Instance to 482. This field defines the parameter that you want to obtain.
- f. Set the Attribute to 9. This field defines that you want to retrieve the parameter value.
- g. Click the Communication tab. See [Figure 85](#).

**Figure 85 - Message Configuration Screen - Communications Tab**

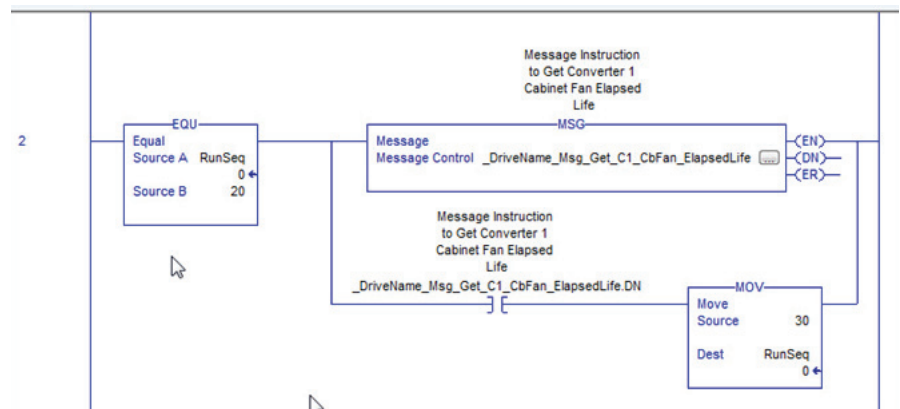
- h. In the Path field, enter the drive name to configure the communication path of the message instruction to that drive.  
In this case, the drive name in the Logix I/O tree is “\_DriveName.”
- i. The value for Total Life returns in the double integer (DINT) data format.  
The raw data = Hours x 100. Divide by 100 to get the Total Life in hours. The CPT block (see [Figure 86](#)) performs this division.

**Figure 86 - Predictive Main Group Parameters (Port 0)**

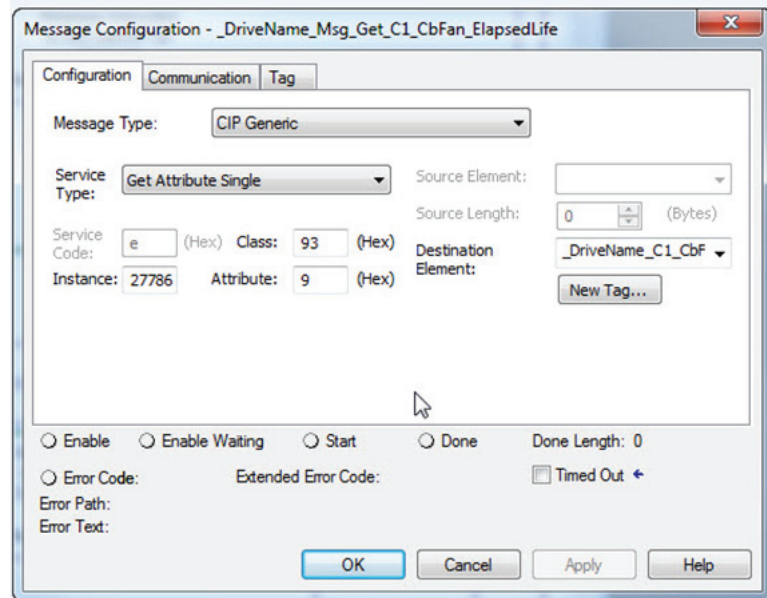
Port 0: Predictive Main Group Parameters				
#	Parameter Name	Value	Units	Internal Value
469	PredMaint Sts	0000000000000000		0
470	PredMaintAmbTemp	50.00	DegC	0x42480000
471	PredMaint Rst En	Disable		0
472	PredMaint Reset	Ready		0
481	CbFan Derate	1.00		0x3F800000
482	CbFan TotalLife	17962.50	Hrs	1796250
483	CbFan ElpsdLife	0.00	Hrs	0
484	CbFan RemainLife	17962.50	Hrs	1796250
485	CbFan EventLevel	80.000	%	0x42A00000
486	CbFan EventActn	Ignore		0
488	HSFan Derate	1.00		0x3F800000
489	HSFan TotalLife	23949.00	Hrs	2394900
490	HSFan ElpsdLife	0.33	Hrs	33
491	HSFan RemainLife	23948.67	Hrs	2394867
492	HSFan EventLevel	80.000	%	0x42A00000
493	HSFan EventActn	Ignore		0
495	InFan Derate	1.00		0x3F800000
496	InFan TotalLife	30238.50	Hrs	3023850
497	InFan ElpsdLife	4612.96	Hrs	461296
498	InFan RemainLife	25625.54	Hrs	2562554
499	InFan EventLevel	80.000	%	0x42A00000
500	InFan EventActn	Ignore		0

- 4. Use a message instruction to retrieve the [Elapsed Life] value for the cabinet fan from converter 1. [Elapsed Life] data returns with a floating point (Real) data format. See [Figure 87](#).

**Figure 87 - Message Instruction for Elapsed Life Parameter**



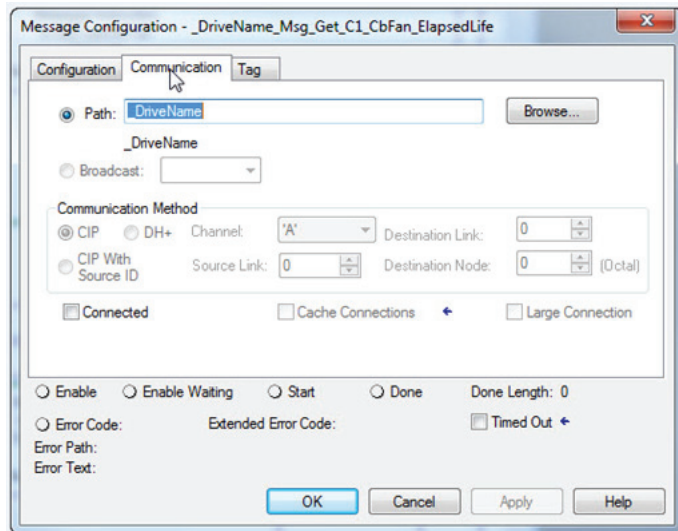
5. Configure the message instructions.
  - a. Click the Configuration tab. See [Figure 88](#).

**Figure 88 - Message Configuration Screen - Configuration Tab**

- b. In the Message Type field, click the down arrow to select CIP Generic.
- c. In the Service Type field, click the down arrow to select Get Attribute Single.
- d. In the Class field, enter 93 (hex); use the EtherNet/IP DPI Parameter Object.
- e. Set the Instance to 27786. This field defines the parameter that you want to obtain.  
The Instance is calculated by adding an offset of 27648 (dec) (as determined by the PowerFlex 750 Ethernet Communications Manual) to the converter 1 [C1 CBFanElpsdLife] parameter number (P138).  
 $27648 \text{ (offset)} + 138 \text{ (parameter number)} = 27786$
- f. Set the Attribute to 9. This field defines that you want to retrieve the parameter value.

g. Click the Communication tab. See [Figure 89](#).

**Figure 89 - Message Configuration Screen - Communication Tab**



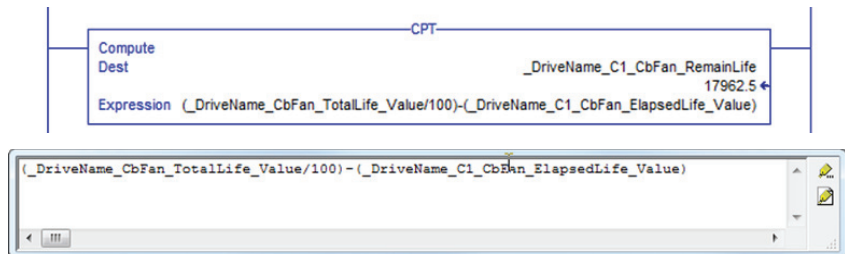
- h. In the Path field, enter the drive name to configure the communication path of the message instruction to that drive.  
In this case, the drive name in the Logix I/O tree is “\_DriveName.”
- i. The [Elapsed Life] data returns with a floating point (Real) data format. The raw data is already in hours. See [Figure 90](#).

**Figure 90 - Predictive Main Group Parameters (Port 11)**

Port 11: Predictive Main Custom Group Parameters			
#	Parameter Name	Value	Units
137	C1 PredMainReset	Ready	
138	C1 CbFanElpsdLif	0.000	Hrs

- 6. To calculate the [Remaining Life] parameter, use a Compute (CPT) instruction with a subtraction expression. See [Figure 91](#).

**Figure 91 - Compute (CPT) Instructions**



## Using DeviceLogix


### Introduction

DeviceLogix™ (DLX) is an embedded component that is located in Port 14 of PowerFlex® 750-Series drives. It is used to control outputs and manage status information locally within the drive. It can function stand-alone or complimentary to supervisory control.

---

**IMPORTANT** The Human Interface Module (HIM) CopyCat function does not work with the following firmware versions.

- PowerFlex 753 firmware version 1.005
  - PowerFlex 755 firmware versions 1.009 or 1.010.
- 

DeviceLogix programming for PowerFlex 750-Series drives is accomplished through a DeviceLogix Editor component (  icon), which is incorporated in the following versions of drive software:

Drive Software Tool	PowerFlex 755 v1.xx	PowerFlex 753 v1.xx, v5.xx PowerFlex 755 v2.xx...v5.xx	PowerFlex 753 v6.xx...v7.xx PowerFlex 755 v6.xx...v7.xx
DriveExplorer	v6.0 <u>1</u> (and higher)	v6.0 <u>2</u> (and higher)	v6.0 <u>4</u> (and higher)
DriveTools™ SP / DriveExecutive	v5.0 <u>1</u> (and higher)	v5.0 <u>2</u> (and higher)	v5.0 <u>5</u> (and higher)
DeviceLogix 5000 Drive Add-On Profiles	v2.0 <u>1</u> (and higher)	v2.0 <u>2</u> (and higher)	v4.0 <u>2</u> (and higher)
Connected Components Workbench	v1.0 <u>2</u> (and higher)	v1.0 <u>2</u> (and higher)	v1.0 <u>2</u> (and higher)

Only the drive software tools that are listed here can be used to program the DeviceLogix component in PowerFlex 750-Series drives. Other DeviceLogix Editors, such as RSNetWorx™ for DeviceNet, cannot be used.

---

**IMPORTANT** DeviceLogix projects that are created with PowerFlex 755 firmware versions 1.009 or 1.010 do not work with firmware version 2.002 or greater. These projects must be opened and adjusted in an editor (for example DriveExplorer™ or DriveExecutive™ software) before being downloaded to the drive.

---

Note the following feature differences between the drive firmware releases:

	PowerFlex 755 v1.xx	PowerFlex 753 v1.xx PowerFlex 755 v2.xx
DeviceLogix Library	Version 3	Version 4
Maximum number of function blocks	90	225
Program update time per number of blocks used	5 ms (fixed): 1...45 blocks 10 ms (fixed): 46...90 blocks	5 ms (fixed): 1...45 blocks 10 ms (fixed): 46...90 blocks 15 ms (fixed): 91...135 blocks 20 ms (fixed): 136...180 blocks 25 ms (fixed): 181...225 blocks

Version 3 of the DeviceLogix library introduced the following new features:

- Analog instructions (compute, math, compare, and so forth)
- Multiple I/O enable line object support
- Cut and Paste capability
- Screen format retention
- Online Help / Bit tool tip

Version 4 of the DeviceLogix library added the following new features:

- Macro Block instruction – the user programs a custom-function block element that contains other function blocks to perform specific tasks
- PID instruction

Version 5 of the DeviceLogix library added the following new features:

- User-defined tags for function block and ladder logic
- MOV and RESET ladder instructions
- Multiple Boolean outputs and inputs for selected instructions
- Function Block diagram I/O selection improvements
- Improved process-order assignment algorithm

**Note:** PowerFlex 755 v1.xxx drives can be flash updated to v2.xxx to take advantage of the new features in the Version 4 release of the DeviceLogix library and the increased number of function blocks.

The PowerFlex 750-Series DeviceLogix can provide basic logic capability for applications that can allow a 5...25 ms scan time depending on program size, plus the time it takes to update the I/O. It can be used in both networked and stand-alone environments. It can also operate autonomous of the drive. For example, it can continue executing if the drive is faulted, or disconnected from AC input power (requires PowerFlex 750-Series 24V DC auxiliary power supply option, catalog number 20-750-APS).

There is no data retention in DeviceLogix during a power cycle. Timer and counter-accumulators, calculation results, latched bits, and so forth, are cleared.

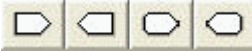


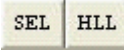

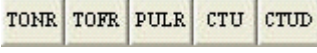

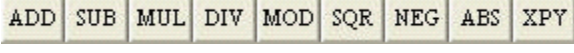




## Parameters

See [page 249](#) Embedded DeviceLogix parameter descriptions.

## Function Block Elements

The following function block elements are available:

Bit and Analog I/O <sup>(1)</sup>	
Process	
Filter	
Select/Limit	
Statistical	
Timer/Counter	
Compare	
Compute/Math	
Move/Logical	
Macro Block	

<sup>(1)</sup> Bit and Analog I/O do not count against the Function Block total. All other elements count, with each instance equal to one Function Block.

The DeviceLogix Editor provides a graphical interface, within which you can configure Function Blocks and provide local control in the drive. DeviceLogix Editor navigation and programming basics is not covered in this manual. See the DeviceLogix System User Manual, publication [RA-UM003](#) for more information.

## Macro Blocks

You can create up to three Macro Blocks, and each can be used 10 times. The selections are empty until you create a Macro Block. You can also create the icon text that is associated with each Macro Block.

## Bit and Analog I/O Points



The DeviceLogix controller in Port 14 uses (48) bit inputs, (48) bit outputs, (24) analog inputs, and (17) analog outputs to interact with the other ports in the drive (both drive and peripheral parameters).

### Bit Inputs

Available bit inputs to the DeviceLogix program include:

Bit Inputs	Description
(16) Hardware Boolean Inputs <ul style="list-style-type: none"> <li>DIP1 to DIP 16</li> </ul>	These inputs correlate with DeviceLogix Port 14 parameters P33 [DLX DIP 01] to P48 [DLX DIP 16]
(32) Network Boolean Inputs <ul style="list-style-type: none"> <li>Ready, Active, Alarm, Faulted, and so forth.</li> </ul>	These inputs correlate with the DeviceLogix Logic Status word for the drive. See <a href="#">page 247</a> for details on the Logic Status word bits.

Bit inputs are used to connect to real-world input devices (push buttons, photoeyes, and so forth) that are wired to an I/O option module in the drive, monitor drive status, or to read a bit in a bit-enumerated parameter.

### Bit Outputs

Available bit outputs from the DeviceLogix program include:

Bit Outputs	Description
(16) Hardware Boolean Outputs <ul style="list-style-type: none"> <li>DOP1 to DOP 16</li> </ul>	These outputs correlate with the bits in DeviceLogix Port 14 parameter P51 [DLX DigOut Sts2]
(32) Network Boolean Outputs <ul style="list-style-type: none"> <li>Stop, Start, Jog1, Clear Faults, and so forth.</li> </ul>	These outputs correlate with the DeviceLogix Logic Command word for the drive. See <a href="#">page 247</a> for details on the Logic Command word bits. These bits can also be monitored in DeviceLogix Port 14 parameter P50 [DLX DigOut Sts].

Bit Outputs are used to connect to real-world output devices (pilot lights, relays, and so forth) that are wired to an I/O option module in the drive, to control the drive directly via Logic Command bits, or to write a bit in a bit-enumerated parameter.

## Analog Inputs

Available analog inputs to the DeviceLogix program include:

Analog Inputs	Description
(12) Hardware Analog Inputs <ul style="list-style-type: none"> <li>DLX Real InSP1 to DLX Real InSP8 (Real)</li> <li>DLX DINT InSP1 to DLX DINT InSP4 (DINT)</li> </ul>	Scratchpad registers for DLX program input use.
(17) Network Analog Inputs <ul style="list-style-type: none"> <li>Common Feedback (Real)</li> <li>DLX In 01 to DLX In 14 (Real)</li> <li>DLX In 15 to DLX In 16 (DINT)</li> </ul>	The Common Feedback correlates with the Feedback word for the drive. The DLX In's correlate with DeviceLogix Port 14 parameters P17 [DLX In 01] to P32 [DLX In 16]
(7) Miscellaneous Analog Inputs <ul style="list-style-type: none"> <li>Real-Time Clock data</li> </ul>	Year, Month, Day, DayofWeek, Hour, Minute, and Second from the Real-Time Clock in the drive

Analog Inputs are typically used to connect to real-world input devices (sensor, potentiometer, and so forth) that are wired to an I/O option module in the drive, monitor drive Feedback, read the Real-Time Clock, or to read a drive / peripheral parameter.

**Note:** Hardware Analog Inputs are available in the PowerFlex 753 and v2.xxx (and higher) PowerFlex 755 drives.

## Analog Outputs

Available analog outputs from the DeviceLogix program include:

Analog Outputs	Description
(12) Hardware Analog Outputs <ul style="list-style-type: none"> <li>DLX Real OutSP1 to DLX Real OutSP8 (Real)</li> <li>DLX DINT OutSP1 to DLX DINT OutSP4 (DINT)</li> </ul>	Scratchpad registers for DLX program output use.
(17) Network Analog Outputs <ul style="list-style-type: none"> <li>Reference Command (Real)</li> <li>DLX Out 01 to DLX Out 14 (Real)</li> <li>DLX Out 15 to DLX Out 16 (DINT)</li> </ul>	The Reference Command correlates with the Reference word for the drive. The DLX Out's correlate with DeviceLogix Port 14 parameters P1 [DLX Out 01] to P16 [DLX Out 16]


Analog Outputs are typically used to connect to real-world output devices (meter panel, valve, and so forth) that are wired to an I/O option module in the drive, control the Reference to the drive, or to write a drive / peripheral parameter.

**Note:** Hardware Analog Outputs are available in the PowerFlex 753 and v2.xxx (and higher) PowerFlex 755 drives.

## Tips

### Data Types

The DeviceLogix Analog In/Out parameters support different data types. For example, P17 [DLX In 01] is a Real whereas P32 [DLX In 16] is a DINT. Be sure to assign a DLX In / Out to a parameter that has the same data type.

Function Block elements also support different data types. Click the Properties Button  in the upper right-hand corner of each element to display the Function Block properties. The Function Data Type field displays the supported data types. If Real DLX Ins are used with a Function Block element configured for DINT (typical default), the fraction is truncated.

### PowerFlex 755 v1.xxx Firmware Datalinks and internal DeviceLogix scratchpad registers (P54...P81)

Each DLX In and DLX Out is a Datalink and cannot be directly mapped to each other or another Datalink, such as a Datalink in the Port 13 Embedded EtherNet/IP. Use the DeviceLogix internal scratchpad registers to pass data between the Datalinks.

#### Example 1 – Reading data from the network

A value from the network is input to DLX Real SP 1.

N:P.P.#	Name	Value
[11: 13.1]	DL From Net 01	Port 14: DLX Real SP1

DLX In 01 reads DLX Real SP1 and can now be used as an Analog Input in the DeviceLogix program.

N:P.P.#	Name	Value
[11: 14.17]	DLX In 01	Port 14: DLX Real SP1

DLX Real SP1 is the intermediary register that allows the two Datalinks to work together.

Example 2 – Writing data to the network

The DeviceLogix program controls an Analog Output value in DLX Out 01, which is written to DLX Real SP2.

N:P.P.#	Name	Value
[11: 14.1]	DLX Out 01	Port 14: DLX Real SP2

The DLX Real SP2 value is output to the network.

N:P.P.#	Name	Value
[11: 13.17]	DL To Net 01	Port 14: DLX Real SP2

DLX Real SP2 is the intermediary register that allows the two Datalinks to work together.

### **PowerFlex 753 (all) and PowerFlex 755 v2.xxx (and higher) Datalinks and internal DeviceLogix scratchpad registers (P82...P105)**

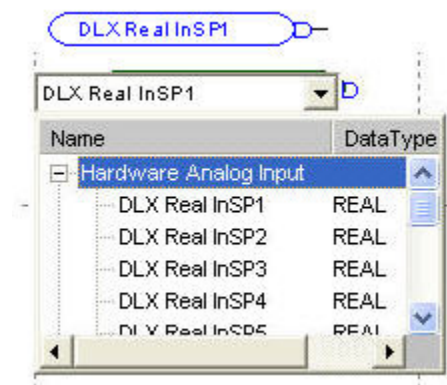
Each DLX In and DLX Out is a Datalink and cannot be directly mapped to each other or another Datalink, such as a Datalink in the Port 13 Embedded EtherNet/IP. Although the same method used with PowerFlex 755 v1.xxx firmware can be employed, there is a more efficient method that does not require a DeviceLogix Datalink to be used.

Example 1 – Reading data from the network

A value from the network is input to DLX Real InSP1.

Drive	Datalink	Value
753	Port 0 P895 [Data In A1]	Port 14: DLX Real InSP1
755	Port 13 P1 [DL From Net 01]	

DLX Real InSP1 can now be used as a Hardware Analog Input and used directly with a Function Block (a DeviceLogix Datalink is not required).

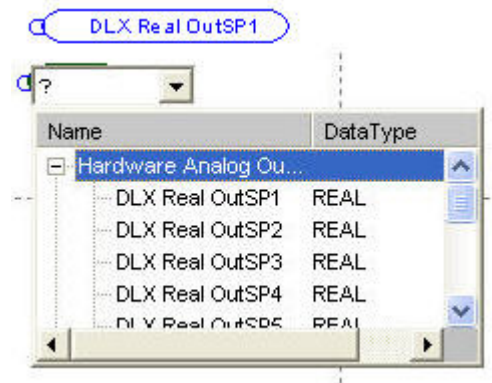


Example 2 – Writing data to the network

The DeviceLogix program controls an Analog Output value, which is written to DLX Real OutSP1.

Drive	Datalink	Value
753	Port 0 P905 [Data Out A1]	Port 14: DLX Real OutSP1
755	Port 13 P17 [DL To Net 01]	

DLX Real OutSP1 can now be used as a Hardware Analog Output and used directly with a Function Block (a DeviceLogix Datalink is not required).



**Program Examples**

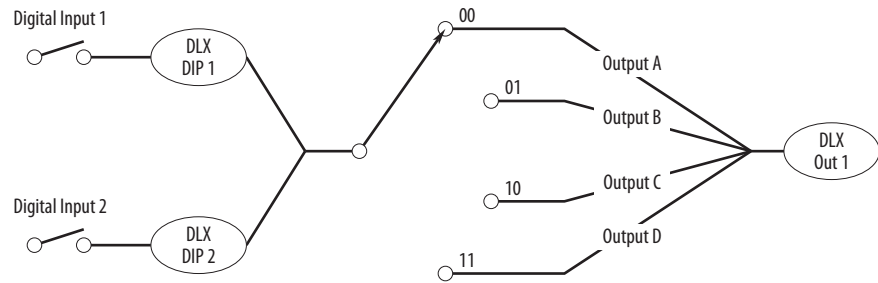
**Example 1: Selector Switch Operation**

This example demonstrates how a selector switch operation similar to the feature in the PowerFlex 700S can be achieved through the embedded DeviceLogix in the PowerFlex 750-Series drive. A selector switch is simulated in the drive by using a combination of inputs to produce multiple outputs. Digital inputs in the drive are used to output configurable multiple preset speeds (75 Hz, 85 Hz, 95 Hz, and 105 Hz) to P571 [Preset Speed 1]. It is assumed that the 750-Series drive has an I/O module that is installed in Port 4.

The following truth table represents the inputs and outputs for a 4 position selector switch.

Inputs		Outputs	
Input 1	Input 2	Binary Output	Selector Switch Output
0	0	0	Output A
0	1	1	Output B
1	0	2	Output C
1	1	3	Output D

The Logic Map offers a high-level explanation of how these outputs are achieved.

**Figure 92 - Two Input Four Position Selector Switch Logic Map**

Discrete Inputs in the Drive are used for Inputs 1 and Input 2. Output A, B, C, and D is linked to DeviceLogix Scratchpad Registers. The scratchpad feature allows further flexibility to modify the values of these outputs.

The resulting output can be linked to a parameter and be used to support drive applications, such as configuring multiple preset speeds and point-to-point positioning. In this example, it controls Preset Speed 1.

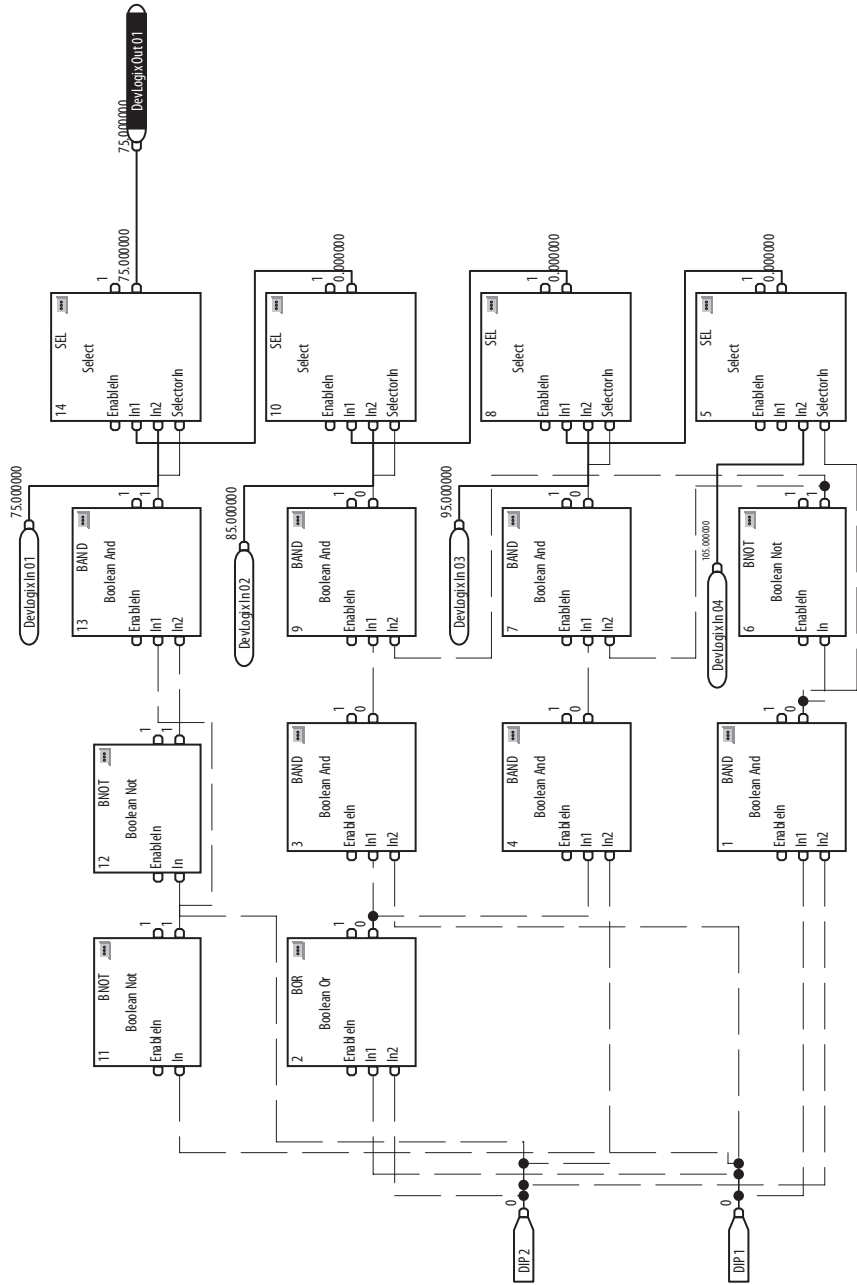
#### *Parameter Configuration*

The following parameters are configured for this example:

Port Parameter No.	Parameter	Value	Description
14.1	DLX Out 01	Port 0: Preset Speed 1	
14.33	DLX DIP 1	Port 4: Dig In Status.Input 1	Digital input 1 from Selector Switch
14.34	DLX DIP 2	Port 4: Dig In Status.Input 2	Digital input 2 from Selector Switch
14.17	DLX In 01	Port 14: DLX Real SP1	Output A
14.18	DLX In 02	Port 14: DLX Real SP2	Output B
14.19	DLX In 03	Port 14: DLX Real SP3	Output C
14.20	DLX In 04	Port 14: DLX Real SP4	Output D
14.54	DLX Real SP1	75.00	Output A Preset Speed
14.55	DLX Real SP2	85.00	Output B Preset Speed
14.56	DLX Real SP3	95.00	Output C Preset Speed
14.57	DLX Real SP4	105.00	Output D Preset Speed
0.571	Preset Speed 1	varies	Output from Selector Switch

### Functional Block Programming

The Selector Switch Operation example consists of 14 blocks that are shown in the following figure.

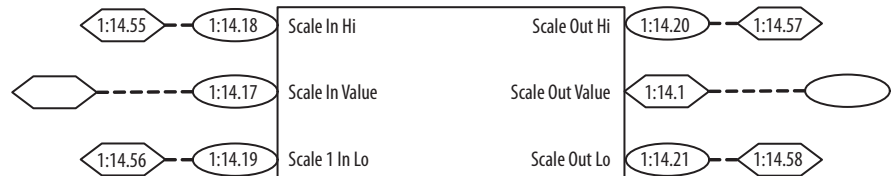




## Example 2: Scale Block Operation

This example demonstrates how a scale block operation similar to the feature in the PowerFlex 700VC can be achieved through the embedded DeviceLogix in the PowerFlex 750-Series drive. A Scale Block scales a parameter value and the input of the block is linked to a parameter that is desired to be scaled. The scale block also has both input and output high limits and low limit parameters.

**Figure 93 - Scale Block High-Level View**



**Scale In Hi** determines the high value for the input to the scale block.

**Scale Out Hi** determines the corresponding high value for the output of the scale block.

**Scale In Low** determines the low value for the input to the scale block.

**Scale Out Lo** determines the corresponding low value for the output of the scale block.

**Scale Out Value** of the block is then available for user to link to any parameter that accepts links.

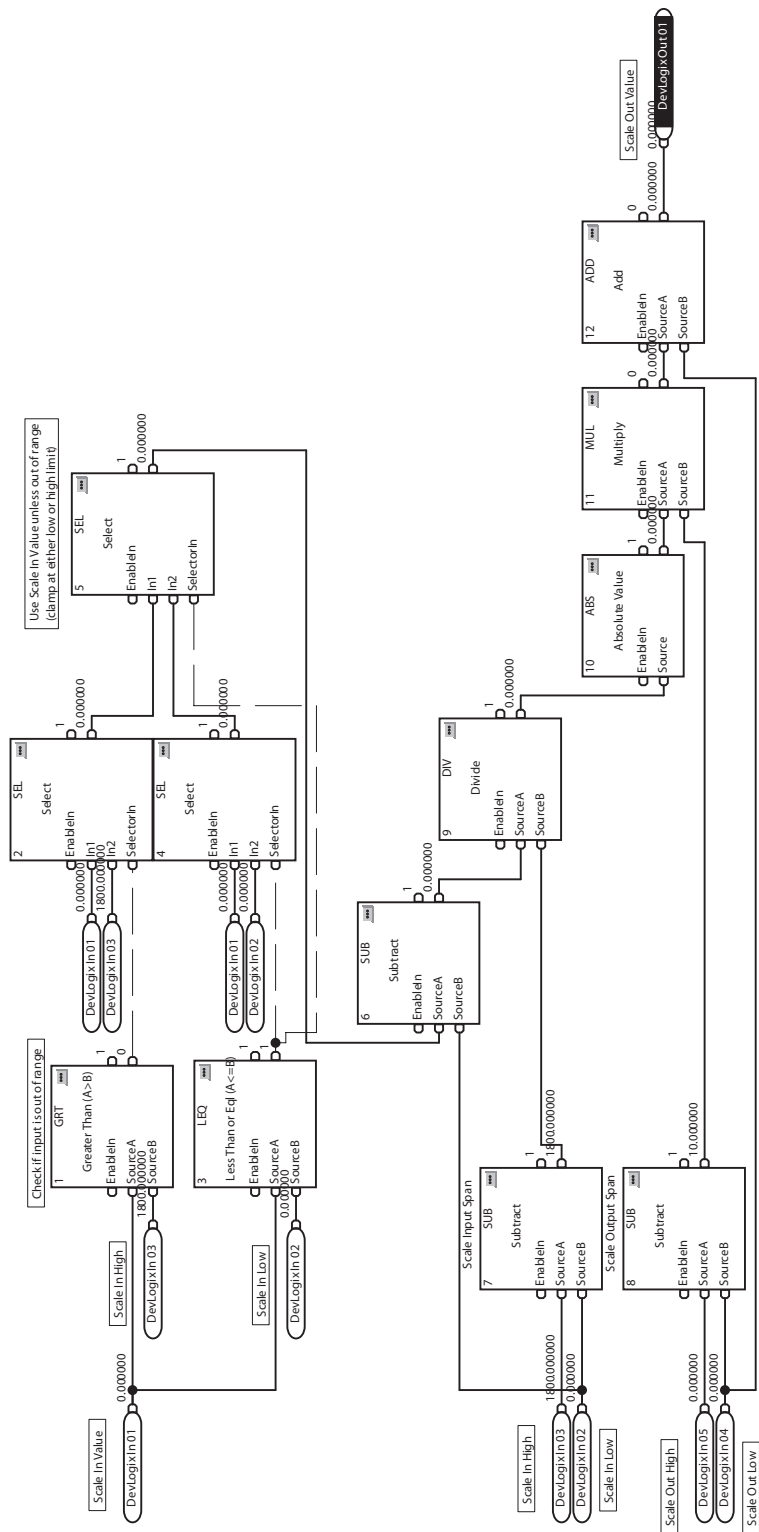
### *Parameter Configuration*

The following DeviceLogix parameters are configured for this example:

Port Parameter No.	Parameter	Value	Description
14.1	DLX Out 01	* Set to the Scale Output write source *	A floating point output that can be controlled by the DeviceLogix program
14.17	DLX In 01	* Set to the Scale Input value read source *	A floating point input that can be read by the DeviceLogix program.
14.18	DLX In 02	Port 14: DLX Real SP2	Scale In Low
14.19	DLX In 03	Port 14: DLX Real SP3	Scale In High
14.20	DLX In 04	Port 14: DLX Real SP4	Scale Out Low
14.21	DLX In 05	Port 14: DLX Real SP5	Scale Out High
14.55	DLX Real SP2	0.0	Scale In Low value
14.56	DLX Real SP3	1800.00	Scale In High value
14.57	DLX Real SP4	0.000	Scale Out Low value
14.58	DLX Real SP5	10.00	Scale Out High value

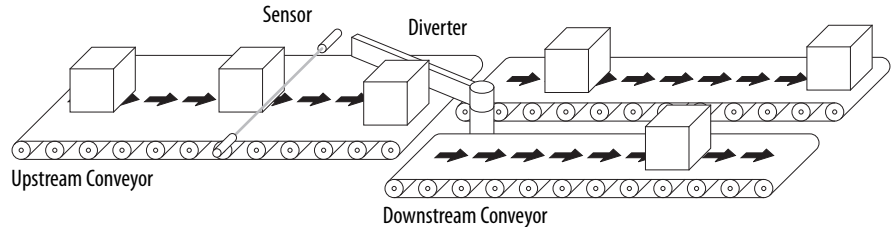
### Functional Block Programming

The Scale Block Operation example consists of 12 blocks that are shown in the following figure.



### Example 3: Diverter Operation

This example demonstrates basic control logic to operate a diverter in a conveyor system. The diverter directs parts from an upstream conveyor to one of two downstream conveyors. It alternately sends 'x' parts down each downstream conveyor.



The application consists of the following discrete I/O:

Type	Name	Description
Inputs	Part Present Sensor	Identifies that a part is present
Outputs	Diverter Actuator	Controls the diverter actuator to direct the flow of parts

Example logic requirements:

- If Part Present Sensor is ON, then increment the parts counter
- If the parts-counter preset is reached, reset the counter and alternately set or reset the Diverter Actuator

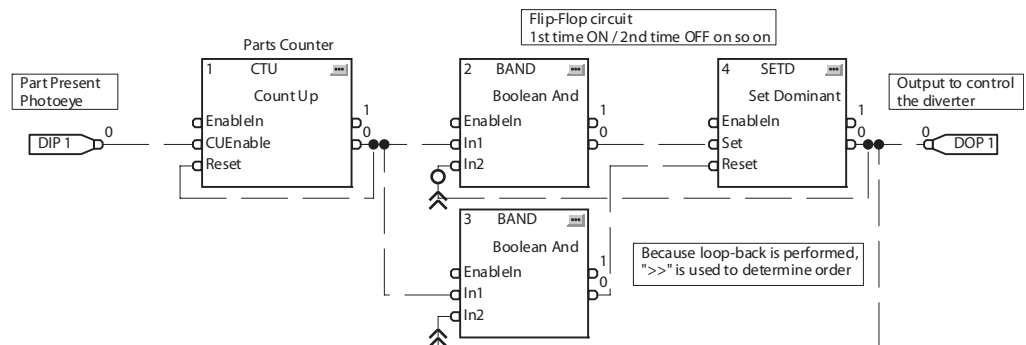
#### Parameter Configuration

The following parameters are configured for this example:

Port Parameter No.	Parameter	Value	Description
4.20	T00 Select	Port 14: DLX DigOut Sts2.DLX DOPSts0	Output on I/O module in Port 4
14.33	DLX DIP 1	Port 4: Dig In Status.Input 1	Part Present Sensor input (I/O module in Port 4)
14.51	DLX DigOut Sts2		Diverter Actuator output

#### Functional Block Programming

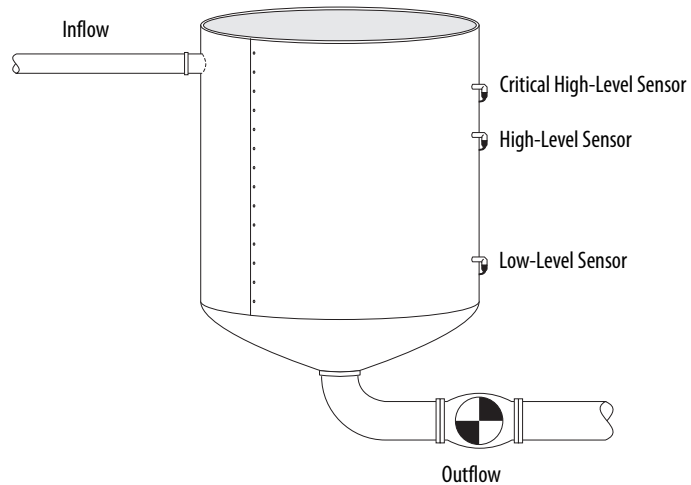
This example consists of four blocks that are shown in the following figure.



### Example 4: Wet Well Operation

This example demonstrates how basic control logic can be used for simple applications. It is assumed that the PowerFlex 755 has an I/O module installed in Port 4.

Figure 94 - Wet Well



The application consists of the following discrete I/O:

Type	Name	Description
Inputs	Fault Reset pushbutton	Used to reset any faults or alarms
	Critical High-Level sensor	Indicates a critically high level. It is normally a backup to the High-Level sensor and is also used to detect if the High-Level sensor is faulty. When ON, the drive operates at an even higher output frequency in case it is due to a high inflow.
	High-Level sensor	Indicates the well is at a high level and it is time to start pumping (normal operation). The drive operates at a 'normal' rate unless the Critical High Level was reached.
	Low-Level sensor	When OFF, it is used to indicate that the well is empty (as long as the High and Critical High-Level sensors are also OFF). The drive stops operating (end of pumping cycle).
Outputs	Sensor Fault pilot light	Indicates that there is a problem with either the High-Level or Low-Level sensors
	Too Much Time Alarm pilot light	If the drive operates for more than the normal amount of time it takes to empty the well, there can be increased inflow or perhaps the Low-Level sensor is stuck ON. An alarm indication is made and the drive continues to operate.
	Critical High-Fault flashing light / alarm horn	Indicates a critically high level that requires immediate attention.

Example logic requirements:

- If Critical High-Level or High-Level sensor is ON, then start the drive.
  - If Critical High-Level sensor is ON, then switch to higher rate (90 Hz) for the rest of the pumping cycle. Else run at the normal rate (60 Hz)
  - Run until all three level sensors are OFF
  - Pump should run at least 'x' minutes at a minimum. If the Low-Level sensor fails, this prevents the High-Level sensor from cycling the pump On/Off too quickly.
- Annunciate a Sensor Fault condition
  - The Low-Level sensor should never be OFF when either the High Level or Critical High-Level sensors are ON
  - The High-Level sensor should never be OFF when the Critical High-Level sensor is ON
  - The Critical High-Level sensor should never be ON when either the High-Level or Low-Level sensors are OFF
- Annunciate a Critical High-Level condition
  - The Critical High-Level output should never be ON
- Annunciate if pumping cycle time is longer than normal ('y' minutes)
  - Monitor the amount of time a pump cycle takes by timing how long the drive is operating.
  - If greater than 'y' minutes, energize the Too Much Time Alarm output
- Reset alarms / faults with a Reset pushbutton input

### *Parameter Configuration*

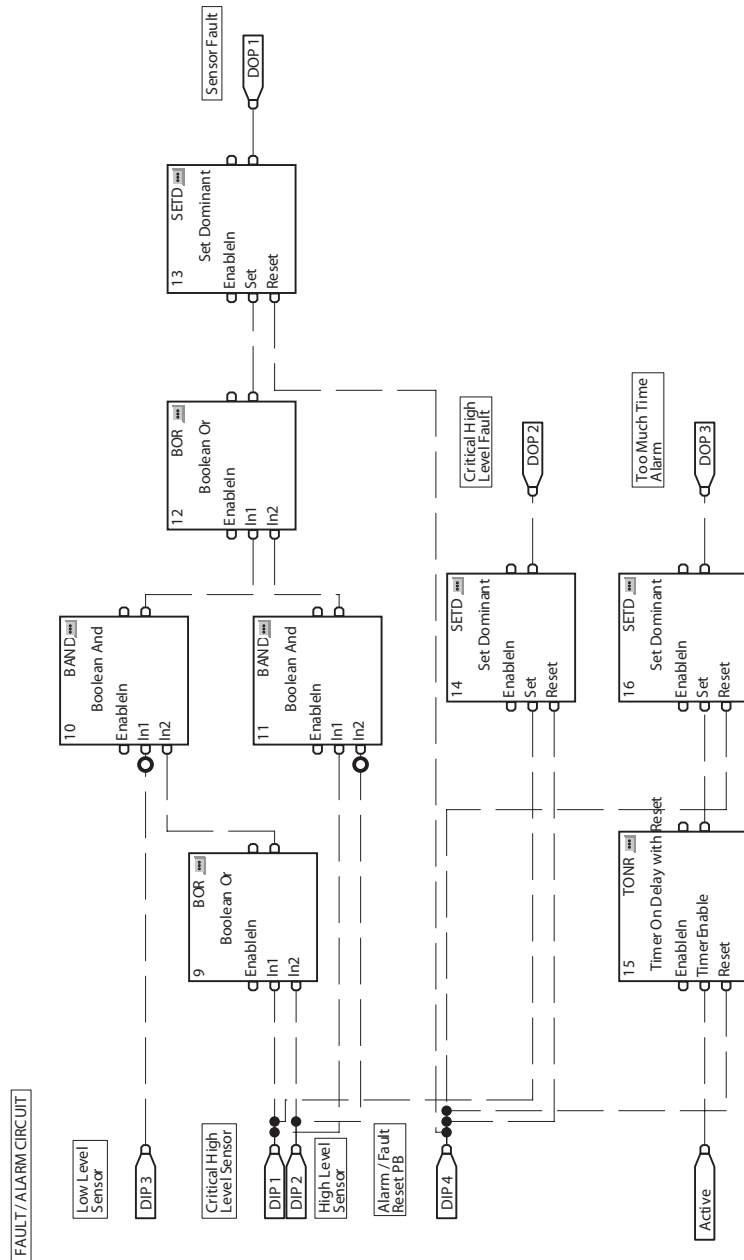
The following parameters are configured for this example.

The following DeviceLogix parameters are configured for this example:

Port Parameter No.	Parameter	Value	Description
0.520	Max Fwd Speed	90.00	
0.545	Speed Ref A Sel	Port 0: Preset Speed 1	
0.571	Preset Speed 1	60.00	Normal pumping rate (60 Hz)
0.573	Preset Speed 3	90.00	High speed pumping rate (90 Hz)
4.10	R00 Select	Port 14: DLX DigOut Sts2.DLX DOPSts0	Sensor Fault output
4.20	T00 Select	Port 14: DLX DigOut Sts2.DLX DOPSts1	Critical High-Level Fault output
4.30	T01 Select	Port 14: DLX DigOut Sts2.DLX DOPSts2	Too Much Time Alarm output
14.33	DLX DIP 1	Port 4: Dig In Status.Input 1	Critical High-Level Sensor input
14.34	DLX DIP 2	Port 4: Dig In Status.Input 2	High-Level Sensor input
14.35	DLX DIP 3	Port 4: Dig In Status.Input 3	Low-Level Sensor input
14.36	DLX DIP 4	Port 4: Dig In Status.Input 4	Alarm / Fault Reset pushbutton input



Figure 96 - Fault/Alarm Circuit



### Example 5: Utilizing the Real-Time Clock

This example demonstrates how to utilize the PowerFlex 750-Series drive Real-Time Clock in a DeviceLogix program.

Example logic requirements:

- Run the drive Monday through Friday between 7:45 a.m. and 5:15 p.m

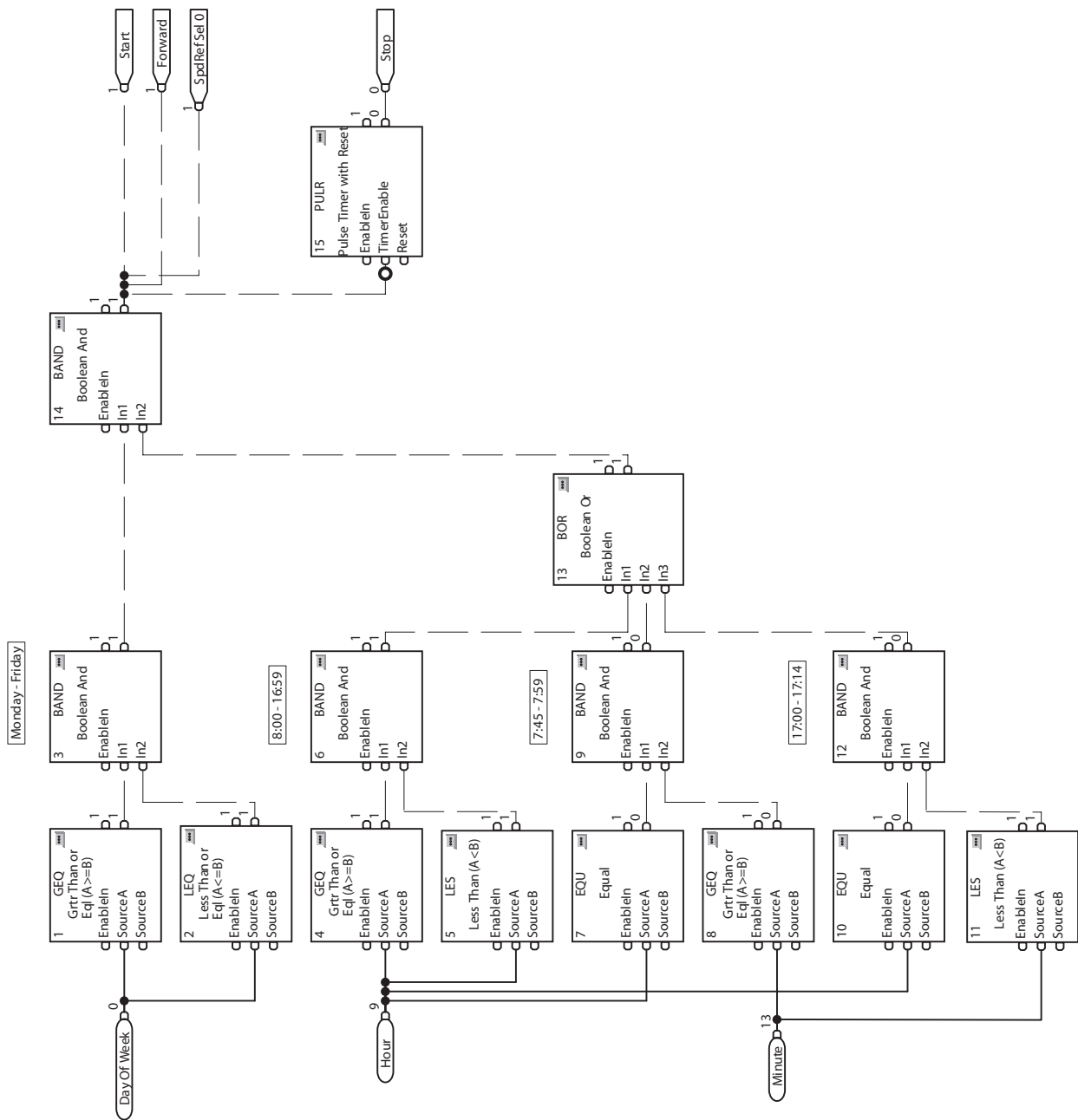
### Parameter Configuration

The following parameters are configured for this example:

Port Parameter No.	Parameter	Value	Description
0.545	Speed Ref A Sel	Port 0: Preset Speed 1	
0.571	Preset Speed 1	60.00	Operating speed of drive

### Functional Block Programming

This example consists of 15 blocks that are shown in the following figure.





## Permanent Magnet Motors

### Compatible Allen-Bradley Servo Motors

[Table 27](#) contains a list of specifications for Allen-Bradley servo motors compatible with PowerFlex 750-Series drives. This information is provided to help configure PowerFlex 750-Series drives with the appropriate servo motor data. For information regarding compatibility and configuration of any Allen-Bradley servo motors (including RDB Series Direct Drive Motors) and third-party PM motors that are not listed here, contact Allen-Bradley Drives Technical Support.

When using a PowerFlex 755 drive to control a permanent magnet motor, the motor feedback device must have a resolution so that the number of pulses per revolution (PPR) is an exponent of two.

For example: 512, 1024, 2048, 4096, 8192...524288, 1048576...

Table 27 - Motor Name Plate and Rating Specifications

Model Number	Motor NP Volts (line to line V rms)	Motor NP Amps (A rms)	Motor NP Hertz (Hz)	Motor NP RPM (oper. rpm)	Motor NP Power (kW)	Motor Poles	Current peak (A rms)	System Cont. Stall Torque (N·m)	Motor Max RPM (rpm)
MPM-A1151M	240	4.2	333.3	5000	0.90	8	21.6	2.18	6000
MPM-A1152F	240	5.9	266.7	4000	1.40	8	31.7	4.74	5000
MPM-A1302F	240	7.4	266.7	4000	1.65	8	35.6	5.99	4500
MPM-A1304F	240	8.1	233.3	3500	2.20	8	34.2	9.30	4000
MPM-A1651F	240	14.5	200.0	3000	2.50	8	52.2	10.70	5000
MPM-A1652F	240	18.1	233.3	3500	4.03	8	73.0	13.50	4000
MPM-A1653F	240	23.2	200.0	3000	5.10	8	84.3	18.60	4000
MPM-A2152F	240	33.7	133.3	2000	5.20	8	89.0	27.00	4000
MPM-A2153F	240	32.8	133.3	2000	5.80	8	85.2	34.00	4600
MPM-A2154C	240	24.8	116.7	1750	6.50	8	89.8	55.00	2000
MPM-A2154E	240	29.6	133.3	2000	7.00	8	90.7	44.00	2650
MPM-B1151F	480	1.5	266.7	4000	0.75	8	7.0	2.18	5000
MPM-B1151T	480	3.1	333.3	5000	0.90	8	14.5	2.18	7000
MPM-B1152C	480	2.3	166.7	2500	1.20	8	8.8	2.18	3000
MPM-B1152F	480	2.9	266.7	4000	1.40	8	15.5	4.74	5200
MPM-B1152T	480	5.2	266.7	4000	1.40	8	26.8	4.74	7000
MPM-B1153E	480	2.7	200.0	3000	1.40	8	15.3	6.55	3500
MPM-B1153F	480	3.2	266.7	4000	1.45	8	22.6	6.55	5500
MPM-B1153T	480	5.5	266.7	4000	1.45	8	39.2	6.55	7000
MPM-B1302F	480	3.4	266.7	4000	1.65	8	15.6	5.99	4500
MPM-B1302M	480	5.0	266.7	4000	1.65	8	22.6	5.99	6000
MPM-B1302T	480	6.6	266.7	4000	1.65	8	30.7	5.99	7000
MPM-B1304C	480	3.4	183.3	2750	2.00	8	15.8	10.20	2750
MPM-B1304E	480	4.1	166.7	2500	2.20	8	24.2	10.20	4000
MPM-B1304M	480	7.3	233.3	3500	2.20	8	42.9	10.20	6000
MPM-B1651C	480	4.7	200.0	3000	2.50	8	20.6	10.70	3500
MPM-B1651F	480	8.2	200.0	3000	2.50	8	36.0	10.70	5000
MPM-B1651M	480	10.9	200.0	3000	2.50	8	40.2	10.70	5000
MPM-B1652C	480	7.0	166.7	2500	3.80	8	23.8	16.00	2500
MPM-B1652E	480	8.0	233.3	3500	4.30	8	42.8	19.40	3500
MPM-B1652F	480	11.0	233.3	3500	4.30	8	59.5	19.40	4500
MPM-B1653C	480	10.5	133.3	2000	4.60	8	41.9	26.80	2500
MPM-B1653E	480	10.2	200.0	3000	5.10	8	51.6	26.80	3500
MPM-B1653F	480	13.2	200.0	3000	5.10	8	66.7	26.80	4000
MPM-B2152C	480	12.3	133.3	2000	5.60	8	39.2	36.70	2500
MPM-B2152F	480	18.7	166.7	2500	5.90	8	69.3	33.00	4500
MPM-B2152M	480	21.0	166.7	2500	5.90	8	54.0	30.00	5000
MPM-B2153B	480	12.7	116.7	1750	6.80	8	42.4	48.00	2000
MPM-B2153E	480	19.3	133.3	2000	7.20	8	69.7	48.00	3000
MPM-B2153F	480	22.1	133.3	2000	7.20	8	69.6	45.00	3800
MPM-B2154B	480	13.9	116.7	1750	6.90	8	69.3	62.80	2000
MPM-B2154E	480	18.3	133.3	2000	7.50	8	69.5	56.00	3000
MPM-B2154F	480	19.8	133.3	2000	7.50	8	59.3	56.00	3300
MPL-A310P	230	3.4	294.0	4410	0.73	8	9.9	1.58	5000
MPL-A310F	230	2.1	185.3	2780	0.46	8	6.6	1.58	3000
MPL-A320P	230	6.4	271.3	4070	1.30	8	20.9	3.05	5000
MPL-A320H	230	4.6	208.7	3130	1.00	8	13.6	3.05	3500

Model Number	Motor NP Volts (line to line V rms)	Motor NP Amps (A rms)	Motor NP Hertz (Hz)	Motor NP RPM (oper. rpm)	Motor NP Power (kW)	Motor Poles	Current peak (A rms)	System Cont. Stall Torque (N-m)	Motor Max RPM (rpm)
MPL-A330P	230	8.5	280.7	4210	1.80	8	26.9	4.08	5000
MPL-A420P	230	9.0	268.7	4030	2.00	8	32.5	4.74	5000
MPL-A430P	230	11.9	234.0	3510	2.20	8	47.4	5.99	5000
MPL-A430H	230	8.6	184.7	2770	1.80	8	31.8	6.21	3500
MPL-A4520P	230	12.4	234.0	3510	2.20	8	35.4	5.99	5000
MPL-A4520K	230	10.6	223.3	3350	2.10	8	30.4	5.99	4000
MPL-A4530F	230	9.5	144.7	2170	1.90	8	29.7	8.36	2800
MPL-A4530K	230	14.4	196.0	2940	2.50	8	43.8	8.13	4000
MPL-A4540C	230	6.6	93.3	1400	1.50	8	20.5	10.20	1500
MPL-A4540F	230	13.0	162.0	2430	2.60	8	38.2	10.20	3000
MPL-A520K	230	16.3	208.0	3120	3.50	8	46.0	10.70	4000
MPL-A540K	230	29.3	180.7	2710	5.50	8	84.9	19.40	4000
MPL-A560F	230	29.3	125.3	1880	5.50	8	84.9	27.90	3000
MPL-B310P	460	1.7	310.0	4650	0.77	8	3.0	1.58	5000
MPL-B320P	460	3.2	313.3	4700	1.50	8	5.0	3.05	5000
MPL-B330P	460	4.3	274.0	4110	1.80	8	7.0	4.18	5000
MPL-B420P	460	4.5	255.3	3830	1.90	8	9.2	4.74	5000
MPL-B430P	460	6.5	214.0	3210	2.20	8	12.0	6.55	5000
MPL-B4520P	460	6.0	236.7	3550	2.10	8	17.0	5.65	5000
MPL-B4530F	460	5.0	162.0	2430	2.10	8	13.4	8.25	3000
MPL-B4530K	460	7.8	200.7	3010	2.60	8	19.1	8.25	4000
MPL-B4540F	460	6.4	162.0	2430	2.60	8	16.3	10.20	3000
MPL-B4560F	460	8.3	144.7	2170	3.20	8	25.5	14.10	3000
MPL-B520K	460	8.1	208.0	3120	3.50	8	23.3	10.70	4000
MPL-B540K	460	14.5	177.3	2660	5.40	8	42.4	19.40	4000
MPL-B560F	460	14.5	130.7	1960	5.50	8	42.4	26.80	3000
MPL-B580F	460	18.4	132.7	1990	7.10	8	66.5	34.00	3000
MPL-B580J	460	22.6	148.0	2220	7.90	8	66.5	34.00	3800
MPL-B640F	460	22.7	106.0	1590	6.11	8	46.0	36.70	3000
MPL-B660F	460	27.2	81.3	1220	6.15	8	67.9	48.00	3000
MPL-B680D	460	24.0	94.0	1410	9.30	8	66.5	62.80	2000
MPL-B680F	460	33.9	79.3	1190	7.50	8	67.9	60.00	3000
MPL-B860D	460	33.6	96.0	1440	12.50	8	67.5	83.10	2000
MPL-B880C	460	33.6	72.7	1090	12.60	8	69.0	110.00	1500
MPL-B880D	460	40.3	86.7	1300	15.00	8	113.2	110.00	2000
MPL-B960B	460	29.7	62.0	930	12.70	8	63.6	130.00	1200
MPL-B960C	460	38.9	76.0	1140	14.80	8	88.4	124.30	1500
MPL-B960D	460	50.2	76.7	1150	15.00	8	102.5	124.30	2000
MPL-B980B	460	31.8	59.3	890	15.02	8	70.7	162.70	1000
MPL-B980C	460	48.2	67.3	1010	16.80	8	99.0	158.20	1500
MPL-B980D	460	63.6	74.7	1120	18.60	8	141.4	158.20	2000
MPG-A004-031	230	1.8	222.7	3340	0.21	8	4.0	0.60	6000
MPG-A010-031	230	2.1	189.3	2840	0.36	8	6.0	1.21	4875
MPG-A010-091	230	0.9	295.3	4430	0.19	8	2.3	0.41	5900
MPG-A025-031	230	9.9	181.0	1810	0.88	12	19.8	4.65	5200
MPG-A025-091	230	3.0	168.0	1680	0.52	12	8.5	2.95	5625
MPG-A050-031	230	24.7	120.0	1200	1.50	12	53.0	11.90	2510
MPG-A050-091	230	5.0	275.0	2750	0.75	12	15.6	2.60	3775
MPG-A110-031	230	20.2	122.0	1220	2.20	12	53.0	17.20	2875

Model Number	Motor NP Volts (line to line V rms)	Motor NP Amps (A rms)	Motor NP Hertz (Hz)	Motor NP RPM (oper. rpm)	Motor NP Power (kW)	Motor Poles	Current peak (A rms)	System Cont. Stall Torque (N-m)	Motor Max RPM (rpm)
MPG-A110-091	230	17.0	184.0	1840	1.60	12	33.2	8.30	3500
MPG-B010-031	460	1.6	162.7	2440	0.34	8	4.4	1.33	6450
MPG-B010-091	460	0.7	357.3	5360	0.23	8	1.5	0.41	6450
MPG-B025-031	460	4.0	219.0	2190	0.92	12	11.3	4.02	4838
MPG-B025-091	460	1.9	175.0	1750	0.54	12	5.2	2.95	5900
MPG-B050-031	460	16.3	92.0	920	1.20	12	32.5	12.40	2510
MPG-B050-091	460	3.4	290.0	2900	0.79	12	9.9	2.60	4560
MPG-B110-031	460	12.9	112.0	1120	2.00	12	31.1	17.00	2420
MPG-B110-091	460	10.6	184.0	1840	1.60	12	20.5	8.30	3500
1326AB-B410G	460	2.5	118.0	3540	1.00	4	7.4	2.70	5000
1326AB-B410J	460	3.5	165.0	4950	1.40	4	10.4	2.70	7250
1326AB-B420E	460	2.8	70.0	2100	1.10	4	8.5	5.00	3000
1326AB-B420H	460	5.5	137.3	4120	2.20	4	15.6	5.10	6000
1326AB-B430E	460	3.9	67.7	2030	1.40	4	11.7	6.60	3000
1326AB-B430G	460	5.6	114.3	3430	2.30	4	16.8	6.40	5000
1326AB-B515E	460	6.1	70.3	2110	2.30	4	18.3	10.40	3000
1326AB-B515G	460	9.5	88.7	2660	2.90	4	28.5	10.40	5000
1326AB-B520E	460	6.7	71.0	2130	2.90	4	20.1	13.00	3000
1326AB-B520F	460	8.8	70.3	2110	2.90	4	26.4	13.10	3500
1326AB-B530E	460	9.5	74.3	2230	4.20	4	28.5	18.00	3000
1326AB-B720E	460	17.5	70.0	2100	6.80	4	52.5	30.90	3500
1326AB-B720F	460	27.5	117.0	3510	11.70	4	66.5	31.80	5000
1326AB-B730E	460	22.8	78.3	2350	9.60	4	66.5	39.00	3350
1326AB-B740C	460	20.9	52.3	1570	8.70	4	62.7	53.00	2200
1326AB-B740E	460	32.0	79.7	2390	12.70	4	66.5	50.80	3400
1326AS-B310H	460	0.8	204.5	4090	0.30	6	2.4	0.70	6200
1326AS-B330H	460	2.1	204.5	4090	0.90	6	6.0	2.10	6500
1326AS-B420G	460	2.6	179.0	3580	1.20	6	7.8	3.20	5250
1326AS-B440G	460	5.4	149.0	2980	2.00	6	16.2	6.40	5250
1326AS-B460F	460	6.2	148.5	2970	2.80	6	18.6	9.00	4300
1326AS-B630F	460	7.8	142.7	2140	2.40	8	18.5	10.70	4500
1326AS-B660E	460	11.8	100.7	1510	3.40	8	29.8	21.50	3000
1326AS-B690E	460	19.0	87.3	1310	5.00	8	41.3	36.40	3000
1326AS-B840E	460	21.2	79.3	1190	4.70	8	39.5	37.60	3000
1326AS-B860C	460	17.6	77.3	1160	6.00	8	44.4	49.30	2000
1326AH-B330F	460	2.1	0.0	3000	0.75	-	9.0	-	3000
1326AH-B440F	460	3.3	0.0	2500	1.22	-	13.8	-	2500
1326AH-B540F	460	11.1	0.0	2500	2.60	-	47.2	-	2500
3050R-7	390	66.0	50.0	500	30.00	12	132.0	-	500
11050R-7	390	218.0	50.0	500	110.00	12	436.0	-	500

---

## Integrated Motion on EtherNet/IP Application

---

**IMPORTANT** Not all drive functions are accessible when used in an Integrated Motion on EtherNet/IP application.

---

### Introduction

The Integrated Motion on EtherNet/IP application is a feature with v2.xxx and higher firmware PowerFlex® 755 drives. It provides a common user experience as Kinetix® 6500 drives when used with Logix controllers (v19 and higher) on an EtherNet/IP network.

- Same motion profile in RSLogix 5000® provides a common configuration experience. The PowerFlex® 755 drive uses the Motion Properties/Axis Properties and the same motion attributes as the Kinetix® 6500 servo drive.
- Same RSLogix 5000® motion instructions provide a common programming experience. An extra motion instruction, MDS – Motion Drive Start, has also been added to allow a ramped start with “Flying Start” capability (ability to start into a rotating motor).

Two options are available for integrating PowerFlex 755 drives with Logix controllers:

1. “Standard Drive” using Drive Add-on Profiles (AOPs) – RSLogix 5000 software v16 and higher.
2. “Integrated Motion Drive” using Integrated Motion on EtherNet/IP technology – RSLogix 5000 software v19 and higher.

When to consider using Integrated Motion on EtherNet/IP with PowerFlex 755 drives:

- Applications having both servos and drives - convenient to be able to configure/program servos and drives the same way.
- Drive applications that could benefit from motion instructions - servo performance is not needed, but it is advantageous to use the RSLogix 5000 motion instruction set to save development time.

---

**IMPORTANT** Firmware v12 and higher requires RSLogix 5000 v28 and higher to work with Integrated Motion on EtherNet/IP.

---

Special considerations when using PowerFlex 755 drives in Integrated Motion on EtherNet/IP mode:

- A PowerFlex 755 drive does not have the performance of a Kinetix servo and is not intended to be a replacement.

PowerFlex 755 Update	Time
Course Update Period (network)	<ol style="list-style-type: none"> <li>1. 3 ms min. (6 ms min. when used with a permanent magnet motor without feedback).</li> <li>2. Use 5 ms min. when used with Integrated Motion options.</li> <li>3. If a drive is used outside its rated temperature range of 0-50C (32-122F) faults may occur. A possible solution is to increase the course update period to 15 ms min.</li> </ol>
Torque loop	256 us
Velocity loop	1024 us
Position loop	1024 us

- When a PowerFlex 755 is used in Integrated Motion on EtherNet/IP mode, the Logix controller and RSLogix 5000 are the exclusive owners of the drive (same as Kinetix). An HIM or drive software, such as DriveExplorer™ and DriveTools™ SP software, cannot be used to control the drive or change configuration settings. These tools can only be used for monitoring.
- The following peripherals can be installed, see [Feedback Configuration Options on page 519](#) for valid ports and supported combinations:
  - HIM (20-HIM-A6 / -C6S) - monitor only
  - Universal Feedback Encoder Option (20-750-UFB-1)
  - Incremental Encoder Option (20-750-ENC-1)
  - Dual Incremental Encoder Option (20-750-DENC-1)
  - Safe Torque Off Module (20-750-S)
  - Safe Speed Monitor Module (20-750-S1)
  - 24V Aux Control Power Supply (20-750-APS)

Other peripherals such as 20-750 I/O modules are supported with firmware revision 12.001 and later.

- Not all drive functions are available when used in an Integrated Motion on EtherNet/IP application. See the [Parameter / Instance Attribute Mapping](#) tables in this appendix to view which drive parameters correlate to motion attributes. If a parameter is not listed, it is not accessible and its function is not available. Examples of functions that are not available include:
  - DeviceLogix™
  - Pump Jack and Pump Off
  - Position Jump and Traverse



**ATTENTION:** A Kinetix drive automatically reads the permanent magnet motor/encoder configuration data. Conversely, permanent magnet motor/encoder configuration data must be manually entered/tuned when using a PowerFlex 755 drive. If incorrect data is entered, unintended motion could occur when a Motion Servo On (MSO) instruction is executed.

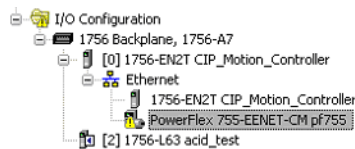
## Feedback Configuration Options

The following feedback module combinations are supported.

Option	Supported Module	Catalog Number	Valid Ports
Two Feedback Options	Single Incremental Encoder	20-750-ENC-1	4...8
	Dual Incremental Encoder	20-750-DENC-1	4...8
	Universal Feedback	20-750-UFB-1	4...6
Two Feedback Options and One Safe Torque Off Option	Single Incremental Encoder	20-750-ENC-1	4 and 5
	Dual Incremental Encoder	20-750-DENC-1	4 and 5
	Universal Feedback	20-750-UFB-1	4 and 5
	Safe Torque Off	20-750-S	6
Two Feedback Options and One Safe Speed Monitor Option <sup>(1)</sup>	Single Incremental Encoder	20-750-ENC-1	4 and 5
	Dual Incremental Encoder	20-750-DENC-1	4 and 5
	Universal Feedback	20-750-UFB-1	4 and 5
	Safe Speed Monitor	20-750-S1	6

(1) The Safe Speed Monitor option module must be used with the 20-750-DENC-1 Dual Incremental Encoder module or the 20-750-UFB-1 Universal Feedback module.

An invalid hardware configuration results in a Module Fault: (Code 16#0010) Mode or state of module does not allow object to perform requested service.



Associated Axes	
Description	pf
Power Structure	480V, 14A, Normal Duty
Status	IO Faulted
Module Fault	(Code 16#0010) Mode or state of module does not allow object to perform requested service

## Considerations for Using Position Feedback Devices on the PowerFlex 755 in the Integrated Motion on EtherNet/IP Context

The PowerFlex 755 drive connects to position feedback devices (encoders) by using one or more feedback option modules that are installed in the control pod.

There are currently three supported types of feedback modules:

- Single Incremental Encoder (20-750-ENC-1)
- Dual Incremental Encoder (20-750-DENC-1)
- Universal Feedback (20-750-UFB-1)

---

**IMPORTANT** Single and dual incremental feedback options, 20-750-ENC-1 and 20-750-DENC-1, cannot use registration inputs. Use the Universal Feedback option 20-750-UFB-1 if registration homing inputs are required.

---

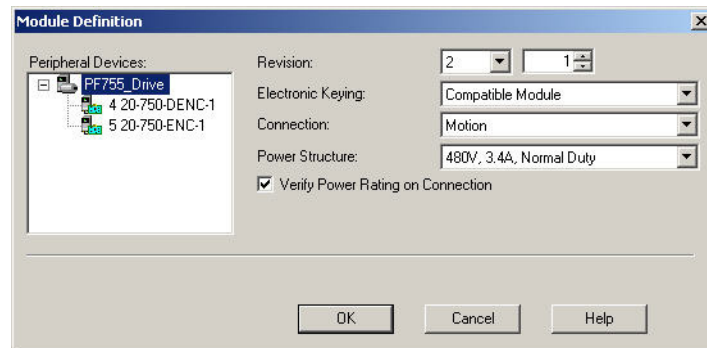
The 20-750-DENC-1 and 20-750-UFB-1 modules contain two “hardware feedback channels”, which means up to two encoders can be connected to each module. The 20-750-ENC-1 only contains one hardware feedback channel.

An Integrated Motion on EtherNet/IP Axis can have up to two feedback devices that are associated with it. When two devices are in use, they are defined as the “Motor Feedback Device” and the “Load Feedback Device.” These two devices are also referred to as “Integrated Motion on EtherNet/IP Feedback 1” and “Integrated Motion on EtherNet/IP Feedback 2,” respectively.

Each Integrated Motion on EtherNet/IP feedback device has an associated Integrated Motion on EtherNet/IP feedback type. The feedback type describes the type of encoder that can be used as that feedback device.

When configuring a drive using RSLogix 5000 and Integrated Motion on EtherNet/IP, the Associated Axes page of the drive Module Properties dialog is used to associate each feedback device with a feedback hardware channel on the drive.

Before using the Associated Axes page, each feedback module present in the drive must be defined on the Module Definition dialog box. The Module Definition dialog box is accessed from the General tab of the Module Properties dialog box for the drive.



After each feedback module has been defined, a drive hardware feedback channel must be selected for each feedback device. A list defines each available channel by the control-pod port number of the feedback module and the channel within that port. A sequential alphabetic character is used to identify each available feedback channel for a module. For example, if a feedback module contains two channels, they are identified as “Channel A” and “Channel B.”

The correct wiring for an encoder in this system depends on three things:

- The type of feedback module
- The type of encoder
- Which hardware feedback channel is used to connect the encoder (A or B)

If there is only one way to wire an encoder to a feedback module, then either hardware Channel A or Channel B can be selected for the feedback module.



If there are two ways to wire an encoder to a feedback module, “Channel A” is used for one set of terminals, and “Channel B” is used for the other set of terminals.

[Table 28](#) identifies the allowed Integrated Motion on EtherNet/IP Feedback types and the correct encoder connection terminals when the feedback module is a 20-750-ENC-1.

**Table 28 - Single Incremental-encoder Feedback Type and Connections**

Integrated Motion on EtherNet/IP Feedback Type	20-750-ENC-1: Channel A Terminals
Not Specified (0)	N/A
Digital AqB (1)	A (NOT), A, B (NOT), B, Z (NOT), Z

[Table 29](#) shows the allowed Integrated Motion on EtherNet/IP Feedback types and the correct encoder connection terminals when the feedback module is a 20-750-DENC-1.

**Table 29 - Dual Incremental-encoder Feedback Type and Connections**

Integrated Motion on EtherNet/IP Feedback Type	20-750-DENC-1: Channel A Terminals	20-750-DENC-1: Channel B Terminals
Not Specified (0)	N/A	N/A
Digital AqB (1)	Encoder 0: A (NOT), A, B (NOT), B, Z (NOT), Z	Encoder 1: A (NOT), A, B (NOT), B, Z (NOT), Z

[Table 30](#) lists the allowed Integrated Motion on EtherNet/IP Feedback types and the correct encoder connection terminals when the feedback module is a Universal Feedback module, 20-750-UFB-1. It also identifies how the two “Device Select” parameters on the 20-750-UFB-1 module are configured in each case.

When a 20-750-UFB-1 module is used in an Integrated Motion on EtherNet/IP system, the “FB0” parameters are always used for configuration and status of Channel A and the “FB1” parameters are always used for configuration and status of Channel B.

[Table 30](#) identifies that, for some Integrated Motion on EtherNet/IP Feedback Types, there are two possible connection schemes using RSLogix 5000. If Channel A is selected, one scheme is used. If Channel B is selected, the other scheme is used. Conversely, for the other Integrated Motion on EtherNet/IP Feedback Types, there is only one possible connection scheme.

The “Digital AqB” Feedback Type is a special case. If only one of the channels on a particular 20-750-UFB-1 module is configured to “Digital AqB”, then the A, B, and Z terminals are used, regardless of whether this type is assigned to Channel A or Channel B. If both channels are configured to “Digital AqB”, then Channel A uses the A, B, Z terminals, and Channel B uses the terminals that are labeled “Sine” and “Cosine”. In this case, they are expected to carry normal AqB encoder signals. These two cases are included in the table.

Configuration of both 20-750-UFB-1 module channels to use the same terminals is considered a configuration error and does not allow proper operation of the system.

**Table 30 Universal Feedback Type and Connections**

Integrated Motion on EtherNet/IP Feedback Type	Channel A (FB0) Device Sel	Channel B (FB1) Device Sel (if different)	Channel A Terminals	Channel B Terminals
Not Specified	None (0)		N/A	
Digital AqB Note: This row only applies if both channels of the UFB <b>Are Not</b> simultaneously configured to Feedback Type = "Digital AqB"	Inc A B Z (12)		-A, A, -B, B, -Z, Z	
Digital AqB Note: This row only applies if both channels of the UFB <b>Are</b> configured to Feedback Type = "Digital AqB"	Inc A B Z (12)	Inc SC (13)	-A, A, -B, B, -Z, Z	Sine (-), Sine (+), Cosine (-), Cosine (+) <b>Note: No Z (marker) input available.</b>
Sine/Cosine	SinCos Only (11)		Sine (-), Sine (+), Cosine (-), Cosine (+)	
Hiperface	Hiperface SC (2)		Sine (-), Sine (+), Cosine (-), Cosine (+), -Xd, +Xd	
EnDat 2.1	EnDat SC (1)		Sine (-), Sine (+), Cosine (-), Cosine (+), -Xc, +Xc, -Xd, +Xd	
EnDat 2.2	EnDat FD ChX (5)	EnDat FD ChY (6)	-Xc, +Xc, -Xd, +Xd	-Yc, +Yc, -Yd, +Yd
SSI (Rotary)	SSI SC (4)		Sine (-), Sine (+), Cosine (-), Cosine (+), -Xc, +Xc, -Xd, +Xd	
SSI (Linear)	LinSSI ChX (18)	LinSSI ChY (19)	-Xc, +Xc, -Xd, +Xd	-Yc, +Yc, -Yd, +Yd
SSI (Full Rotary Digital)	SSI FD ChX	SSI FD ChY	-Xc, +Xc, -Xd, +Xd	-Yc, +Yc, -Yd, +Yd
Stahl SSI	LinStahl ChX (16)	LinStahl ChY (17)	-Xc, +Xc, -Xd, +Xd	-Yc, +Yc, -Yd, +Yd

Although the 20-750-UFB-1 module ostensibly supports two feedback channels, there are many combinations of device types that do not work and result in an error state on the module if they are configured.

See the Feedback Options table located in the PowerFlex 750-Series AC Drives Technical Data, publication [750-TD001](#), for compatible and non-compatible combinations.

Non-compatible selections lead to a Configuration Conflict (Type 2 Alarm): Bit 20 "FB0FB1 Cflct" of parameter 1 [Module Status] is set.

## Torque Prove and Brake Slip Detect



**ATTENTION:** Loss of control in suspended load applications can cause personal injury and/or equipment damage. The drive or a mechanical brake must always control the load. TorqProve™ is designed for lifting/torque prove applications. It is the responsibility of the engineer and/or end user to configure drive parameters, test any lifting functionality and meet safety requirements in accordance with all applicable codes and standards.



**ATTENTION:** When enabling the Torque Prove/Brake Slip detection, the axis application type must be Constant Speed, Tracking, or Custom with Velocity Integral enabled. Failure to do so results in unstable operation upon brake release, because torque pre-load is not applied.



**ATTENTION:** When being used as a positioning axis, the AxisName:MechanicalBrakeReleaseStatus bit must be monitored, along with a timer configured to compensate for brake release time, before a motion command can be performed after the initial MSO instruction. Failure to monitor the mechanical brake release status along with a timer to prevent motion can cause the axis to try to drive through a brake that has not been released. This may cause a Speed Deviation error and fault the axis on a Torque Prove fault. Another option would be to use a digital input as brake open if such a contact exists.

**IMPORTANT** The Stop Type Action cannot be set to Disable and Coast when using torque prove/brake slip detection.

**IMPORTANT** Do not use the MSO, MAJ, and MAM commands when running a TorqProve application without encoder feedback. Start the axis with the MDS instruction and stop the axis the with MSF instruction.

**IMPORTANT** Not all drive functions are accessible when used in an Integrated Motion on EtherNet/IP application.

## Encoder Feedback Operation

### *Velocity Mode using the Motion Drive Start (MDS) Instruction to Operate the Axis*

1. The MDS instruction is initiated. The following actions occur:
  - The axis is enabled.
  - The output phase loss is checked.
  - A torque command is preloaded from a previous move or from a customer-defined, preloaded value.
  - The torque current feedback is verified and the brake is commanded to release.
  - After the brake release time has expired, the axis velocity reference is released.

The axis is now under control velocity command.

2. The Motion Servo Off (MSF) instruction is initiated and the brake prove routine begins.
  - a. If the brake prove routine is successful, the power structure is disabled and the axis enters the Stopped state.
  - b. If the brake has slipped, the axis issues a brake slip alarm and remains active. The axis can be restarted and the load can be lowered to a safe location. When the brake no longer slips after an MSF instruction, the Brake Malfunction fault occurs and requires a power cycle to clear the fault.
  - c. If enabled, the Auto Sag routine issues a brake slip alarm and runs the Auto Sag routine.

The Auto Sag routine repeatedly attempts to set the brake and check for slippage. When the load no longer slips, the power structure is disabled and a Brake Malfunction fault occurs. A power cycle is required to clear the fault. The Auto Sag routine cannot be interrupted.

### *Velocity or Position Modes using a Motion Servo On (MSO) and Move Instructions to Control the Axis*

1. The MSO instruction is initiated. The following actions occur:
  - The axis is enabled.
  - An output phase loss is checked.
  - The torque command is preloaded from a previous move or from a customer-defined, preloaded value.
  - The torque current feedback is verified and a brake release command is issued.
  - Motion is enabled when the brake timer expires.
2. When the brake release timer has expired, motion can be allowed (for example, MAJ, MAM, and MAG).
3. Control the axis as desired for position or velocity.

4. An MSF instruction is initiated and the Brake Proving routine is started when desired.
  - a. If the brake prove routine is successful, the power structure is disabled and the axis enters the Stopped state.
  - b. If the brake has slipped, the axis issues a Brake Slip alarm and remains active. The axis can be restarted and the load lowered to a safe location. When the brake no longer slips after an MSF instruction, the Brake Malfunction fault occurs and requires a power cycle to clear the fault.
  - c. If enabled, the Auto Sag routine issues a Brake Slip alarm and runs the Auto Sag routine.

The Auto Sag routine repeatedly attempts to set the brake and check for slippage. When the load no longer slips, the power structure is disabled and a Brake Malfunction fault occurs. A power cycle is required to clear the fault. The Auto Sag routine cannot be interrupted.

## Settings

### *Parameters to Configure Torque Prove, Brake Check, and Auto Sag*

The following parameters are accessed via the Axis Properties -> Parameter List Category.

**Table 31 - Axis Properties Parameters**

Parameter Name	Description
AutoSagConfiguration	Enables the drive to control the load to a no slip condition by repeatedly attempting to set the brake and test for slip until the load no longer slips. If set to zero, the drive detects a brake slip and holds the load at zero speed.
AutoSagSlipIncrement	The distance in position/feedback units that the brake is allowed to slip before enabling the Auto Sag routine to control a brake slip event. An encoder is required to operate.
AutoSagStart	Enables the routine that monitors the encoder for brake slip when the power structure is disabled. If the brake slips more than the value of AutoSagSlipIncrement, the power structure is enabled and the Auto Sag routine begins. The AutoSagConfiguration parameter must also be enabled. AutoSagStart is not used when encoderless operation is enabled.
BrakeProveRampTime	The time that is required to ramp the torque reference from 100 % to zero during the brake slip test.
BrakeSlipTolerance	Sets the number of motor shaft revolutions allowed during the brake slippage test. Drive torque is reduced to check for brake slippage. When slippage occurs, the drive allows the number of motor shaft revolutions before regaining control. BrakeSlipTolerance is not used when encoderless operation is enabled.
BrakeTestTorque	Percentage of motor rated torque that is used to test the brake before releasing on the brake test. Any setting above 0 enables the brake test routine before releasing the brake for normal motion of the axis. BrakeTestTorque is only active with encoder feedback.
MechanicalBrakeEngageDelay	The time that is required for the brake to mechanically engage the system before the brake slip test begins in encoder feedback mode. In Encoderless, it is the time that the axis will remain active after the brake is commanded to set before the axis power structure is disabled

**Table 31 - Axis Properties Parameters**

Parameter Name	Description
MechanicalBrakeReleaseDelay	Time that is required for the mechanical brake to disengage after the command is issued.
ProvingConfiguration	Enables the Torque Prove/Mechanical Brake control/Brake Slip check routine within the Axis Power Structure.
ZeroSpeed	Percentage of axis motor rated velocity before setting the brake for the brake slip routine in encoder feedback mode. In encoderless operation, it is the point at which the brake is commanded to disengage when accelerating from zero speed and the point at which the brake sets when decelerating toward zero speed.
ZeroSpeedTime	Time the axis must be at or below zero speed before the brake is set in encoder feedback operation.

**IMPORTANT** When a system is configured for operation and the program is downloaded to the processor, the Speed Deviation Band is set to 0 and can cause a speed deviation fault with TorqProve when a move is attempted. To correct this error, an Enhanced Attribute message must be sent to the drive to configure it. Send a 'Real' value from 10...25% to Attribute 2724 decimal or AA4 Hex.

### Encoderless Operation (Velocity or Frequency Sensorless Vector)

1. An MDS instruction is initiated (an MSO instruction is not allowed in encoderless operation).
  - The axis is enabled.
  - An output phase loss is checked.
  - The velocity is increased until the value of ZeroSpeedTolerance is reached and the brake is released.
  - The torque current feedback is verified and a brake release command is issued.
  - After the brake release timer has expired, the axis velocity reference is released.
2. The axis is now under the control of a velocity command.

To stop the system, an MSF instruction must be initiated (a MAS instruction is not allowed in encoderless operation). The velocity ramps down until the value of ZeroSpeedTolerance is reached and the brake is set. Brake slip detection cannot be accomplished.

## PowerFlex 755 Integrated Motion Using Firmware Revision 12.001 or Later

### Add an I/O Module to a PowerFlex 755 Drive

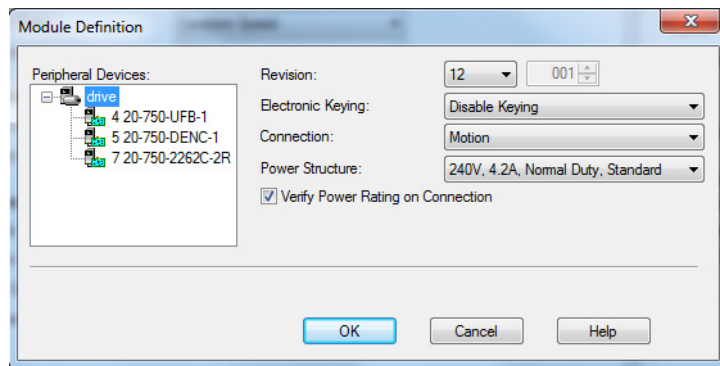
You can add an I/O module to the drive Integrated Motion on EtherNet/IP connection when using PowerFlex 755 firmware revision 12.001 and later and Studio 5000 Logix Designer® version 28.00.02 or later. **The I/O module must be installed in Port 7 in the control pod of a frame 2 or larger PowerFlex 755 drive.**

#### Configure I/O Device Properties

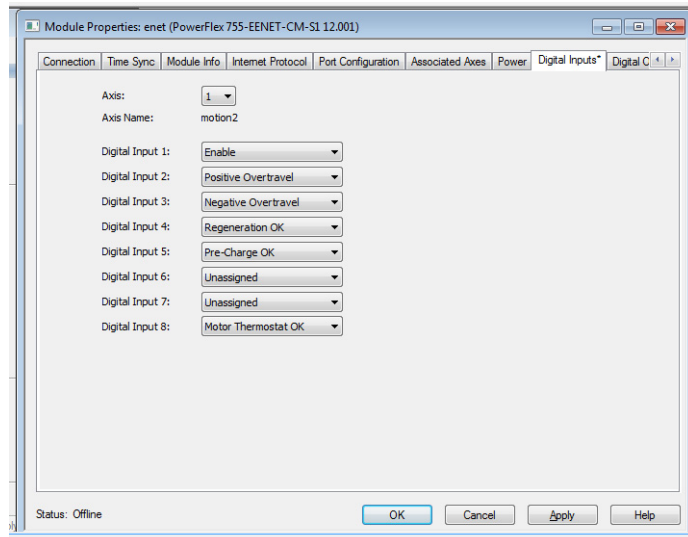
Follow these basic steps to add and configure an I/O module for a PowerFlex 755 drive.

1. In the Module Definition dialog box for the drive, right-click and add an I/O module (new peripheral device) to Port 7.

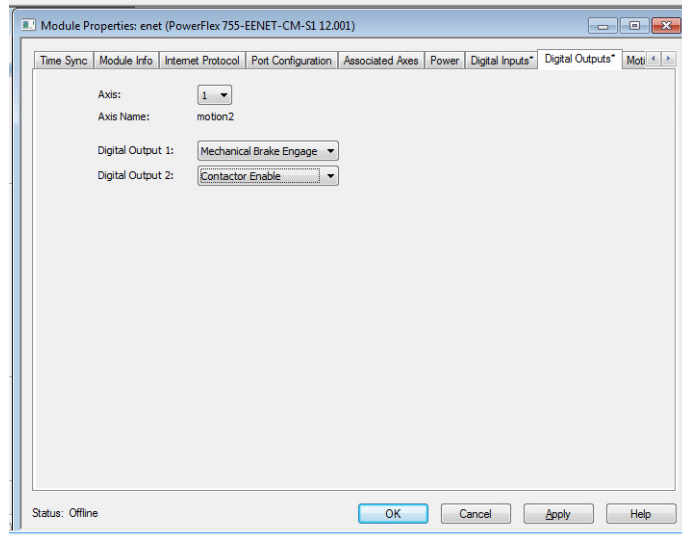
The I/O module has already been added to the drive in this example.



2. In the Module Properties dialog box for the drive, on the Digital Inputs tab, select the appropriate digital input functions.



3. In the Module Properties dialog box for the drive, on the Digital Outputs tab, select the appropriate digital output functions.

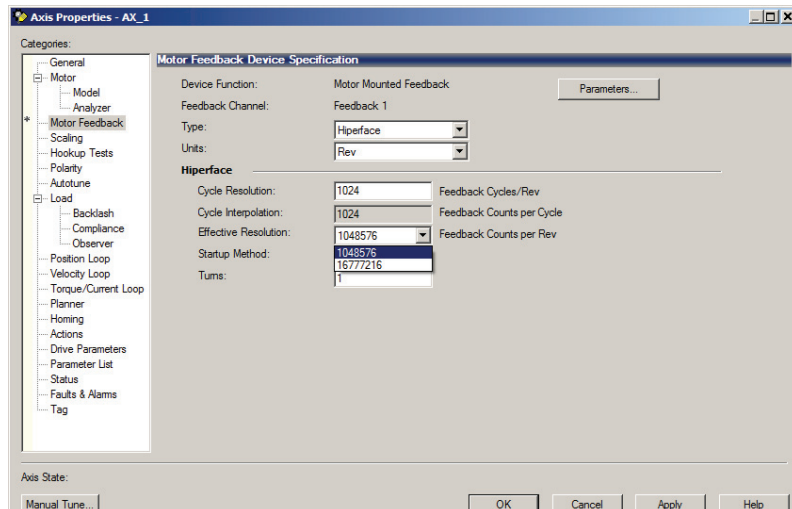


### Configure 20-bit or 24-bit Motor Feedback Device Resolution

You can configure 20-bit or 24-bit effective resolution for the following feedback devices:

- Hiperface
- Heidenhain SC
- SSI SC

Set the desired effective resolution on the Motor Feedback tab of the Axis Properties dialog box for the axis associated with the drive. This feature is available in PowerFlex 755 firmware revision 12.001 and later and Studio 5000 Logix Designer® version 28.00.02 or later.





## Parameter / Instance Attribute Mapping

[Table 32](#) provides the relationship between PowerFlex 755 drive parameters and the Integrated Motion on EtherNet/IP attributes. If a parameter is not listed, it is not accessible and its function is not available.

**Table 32 - Parameter/Instance to Attribute Mapping**

Drive		Integrated Motion
Parameter No.	Parameter Name	Integrated Motion on EtherNet/IP Instance
P1	Output Frequency	Output Frequency
P1	Output Frequency	Output Frequency, I/O Card
P5	Torque Cur Fdbk	Iq Current Feedback
P5	Torque Cur Fdbk	Torque Current Feedback, I/O Card
P6	Flux Cur Fdbk	Id Current Feedback
P7	Output Current	Output Current
P8	Output Voltage	Output Voltage
P9	Output Power	Output Power
P10	Output Powr Fctr	Output Power Factor, Sets Port 7
P11	DC Bus Volts	DC Bus Voltage
P12	DC Bus Memory	DC Bus Voltage - Nominal
P20	Rated Volts	Inverter Rated Output Voltage
P20	Rated Volts	Inverter Rated Output Voltage, Sets Port 7
P21	Rated Amps	Inverter Rated Output Current
P22	Rated kW	Inverter Rated Output Power
P25	Motor NP Volts	Motor Rated Voltage
P26	Motor NP Amps	Motor Rated Continuous Current
P27	Motor NP Hertz	Induction Motor Rated Frequency
P28	Motor NP RPM	Rotary Motor Rated Speed
P30	Motor NP Power	Motor Rated Output Power
P30	Motor NP Power	Motor Rated Output Power, Sets Port 7
P31	Motor Poles	Rotary Motor Poles
P36	Maximum Voltage	Maximum Voltage
P37	Maximum Freq	Maximum Frequency
P44	Flux Up Time	Flux Up Time
P50	Stability Filter	Stability Filter, I/O Card
P60	Start Acc Boost	Start Boost
P60	Start Acc Boost	Start Boost, I/O Card
P61	Run Boost	Run Boost
P62	Break Voltage	Break Voltage
P63	Break Frequency	Break Frequency
P65	VHz Curve	Frequency Control Method
P73	IR Voltage Drop	Induction Motor Stator Resistance
P74	Ixo Voltage Drop	Induction Motor Stator Leakage Reactance
P75	Flux Current Ref	Induction Motor Flux Current
P76	Total Inertia	Kj
P81	PM PriEnc Offset	Commutation Offset
P82	PM AltEnc Offset	PM Motor Alternate Encoder Offset, I/O Card
P86	PM CEMF Voltage	PM Motor Rotary Voltage Constant

**Table 32 - Parameter/Instance to Attribute Mapping (continued)**

Drive		Integrated Motion
Parameter No.	Parameter Name	Integrated Motion on EtherNet/IP Instance
P87	PM IR Voltage	PM Motor Resistance
P88	PM IXq Voltage	PM Motor Inductance
P89	PM IXd Voltage	PM Motor Inductance
P92	PM Vqs Reg Ki	PM Motor Vqs Regulator Integral Gain, I/O Card
P95	VCL Cur Reg BW	Kqp
P126	Pri Vel FdbkFltr	Feedback n Velocity Filter Taps
P155	DI Enable	Digital Input Configuration
P220	Digital In Sts	Digital Inputs
P305	Voltage Class	Bus Voltage Select
P306	Duty Rating	Duty Select
P309	SpdTrqPsn Mode A	Control Mode
P309	SpdTrqPsn Mode A	SLAT Configuration
P314	SLAT Err Stpt	SLAT Set Point
P315	SLAT Dwell Time	SLAT Time Delay
P370	Stop Mode A	Stopping Mode
P372	Bus Reg Mode A	Bus Regulator Action
P375	Bus Reg Level	Bus Regulator Reference
P382	DB Resistor Type	Shunt Regulator Resistor Type
P383	DB Ext Ohms	External Shunt Resistance
P384	DB Ext Watts	External Shunt Power
P385	DB ExtPulseWatts	External Shunt Pulse Power
P388	Flux Braking En	Flux Braking Enable
P394	DC Brake Level	DC Injection Brake Current
P395	DC Brake Time	DC Injection Brake Time
P412	Mtr OL Alarm Lvl	Motor Thermal Overload User Limit
P413	Mtr OL Factor	Motor Overload Limit
P418	Mtr OL Counts	Motor Capacity
P420	Drive OL Mode	Inverter Overload Action
P422	Current Limit 1	Motor Rated Peak Current
P426	Regen Power Lmt	Regenerative Power Limit
P436	Shear Pin1 Level	Overtorque Limit
P437	Shear Pin 1 Time	Overtorque Limit Time
P442	Load Loss Level	Undertorque Limit
P443	Load Loss Time	Undertorque Limit Time
P445	Out PhaseLossLvl	Output Phase Loss Level
P450	Pwr Loss Mode A	Power Loss Action
P451	Pwr Loss A Level	Power Loss Threshold
P452	Pwr Loss A Time	Power Loss Time
P461	UnderVltg Level	Bus Undervoltage User Limit
P520	Max Fwd Speed	Velocity Limit - Positive
P521	Max Rev Speed	Velocity Limit - Negative
P524	Overspeed Limit	Motor Overspeed User Limit
P526	Skip Speed 1	Skip Speed 1

**Table 32 - Parameter/Instance to Attribute Mapping (continued)**

Drive		Integrated Motion
Parameter No.	Parameter Name	Integrated Motion on EtherNet/IP Instance
P527	Skip Speed 2	Skip Speed 2
P528	Skip Speed 3	Skip Speed 3
P529	Skip Speed Band	Skip Speed Band
P535	Accel Time 1	Ramp Acceleration
P537	Decel Time 1	Ramp Deceleration
P540	S Curve Accel	Ramp Jerk Control
P541	S Curve Decel	Ramp Jerk Control
P546	Spd Ref A Stpt	Velocity Feedforward Command
P549	Spd Ref A Mult	Kvff
P597	Final Speed Ref	Velocity Reference
P601	Trim Ref A Stpt	Velocity Trim
P620	Droop RPM at FLA	Kdr
P621	Slip RPM at FLA	Induction Motor Rated Slip Speed
P635	Spd Options Ctrl	Velocity Integrator Control
P639	SReg FB Fltr BW	Feedback n Velocity Filter Bandwidth
P641	Speed Error	Velocity Error
P643	SpdReg AntiBckup	Knff
P644	Spd Err Fltr BW	Velocity Low Pass Filter Bandwidth
P645	Speed Reg Kp	Kvp
P647	Speed Reg Ki	Kvi
P652	SReg Trq Preset	Velocity Integrator Preload
P654	Spd Reg Int Out	Velocity Integrator Output
P659	SReg OutFltr BW	Torque Lead Lag Filter Bandwidth
P660	SReg Output	Velocity Loop Output
P670	Pos Torque Limit	Torque Limit - Positive
P671	Neg Torque Limit	Torque Limit - Negative
P685	Selected Trq Ref	Torque Reference
P686	Torque Step	Torque Trim
P687	Notch Fltr Freq	Torque Notch Filter Frequency
P689	Filtered Trq Ref	Torque Reference - Filtered
P690	Limited Trq Ref	Torque Reference - Limited
P696	Inertia Acc Gain	Kaff
P697	Inertia Dec Gain	Kaff
P704	InAdp LdObs Mode	Load Observer Configuration
P705	Inertia Adapt BW	Feedback n Accel Filter Bandwidth
P706	InertiaAdaptGain	Kof
P707	Load Estimate	Load Observer Torque Estimate
P708	InertiaTrqAdd	Load Observer Acceleration Estimate
P708	InertiaTrqAdd	Total Inertia Estimate
P711	Load Observer BW	Kop
P721	Position Control	Position Integrator Control
P723	Psn Command	Position Reference
P756	Interp Psn Input	Controller Position Command - Float
P757	Interp Vel Input	Controller Velocity Command

**Table 32 - Parameter/Instance to Attribute Mapping (continued)**

Drive		Integrated Motion
Parameter No.	Parameter Name	Integrated Motion on EtherNet/IP Instance
P758	Interp Trq Input	Controller Torque Command
P759	Interp Psn Out	Fine Command Position
P760	Interp Vel Out	Fine Command Velocity
P761	Interp Trq Out	Torque Command
P821	Psn Offset 1	Position Trim
P830	PsnNtchFltrFreq	Position Notch Filter Frequency
P833	Psn Out FltrGain	Position Lead Lag Filter Gain
P834	Psn Out Fltr BW	Position Lead Lag Filter Bandwidth
P835	Psn Error	Position Error
P837	Psn Load Actual	Position Integral Feedback
P838	Psn Reg Ki	K <sub>pi</sub>
P839	Psn Reg Kp	K <sub>pp</sub>
P842	PsnReg IntgrlOut	Position Integrator Output
P843	PsnReg Spd Out	Position Loop Output
P847	Psn Fdbk	Position Feedback
P940	Drive OL Count	Inverter Capacity (See See <a href="#">Motor Overload on page 533</a> )
P942	IGBT Temp C	Inverter Temperature
P944	Drive Temp C	Inverter Heatsink Temperature
P945	At Limit Status	At Limit Status
P1100, Bit 0	Trq Prv Cfg/TP Enable	Proving Configuration
P1100, Bit 6	Trq Prv Cfg/BrkSlipStart	Auto Sag Start
P1100, Bit 9	Trq Prv Cfg/BrkSlp SpdLmt	Auto Sag Config
P1104	Trq Lmt SlewRate	Brake Prove Ramp Time
P1107	Brk Release Time	Mechanical Brake Release Delay
P1108	Brk Set Time	Mechanical Brake Engage Delay
P1109	Brk Alarm Travel	Auto Sag Slip Increment
P1110	Brk Slip Count	Brake Slip Tolerance
P1111	Float Tolerance	Zero Speed
P1113	ZeroSpdFloatTime	Zero Speed Time
P1114	Brake Test Torq	Brake Test Torque

## Motor Overload

There is a difference between how Kinetix handles an overload condition compared to the PowerFlex755 drive. Kinetix is motor capacity whereas PowerFlex 755 is motor overload.

The Motion attribute, Inverter Capacity, is a real-time estimate of the continuous rated motor thermal capacity that is used during operation, which is based on the motor thermal model. A value of 100 % indicates that the motor is being used at 100 % of rated capacity as determined by the continuous current rating of the motor.

The PowerFlex 755 parameter 940 [Drive OL Count] indicates power unit overload ( $I^2T$ ) in percentage. The value of this parameter remains at 0 until 100 % of Rated Current is reached. At 100 % of Rated Current, Overload measurement begins and the power unit overload fault occurs.

## Positive and Negative Overtravel Input

When the PowerFlex 755 drive is in integrated motion mode, Logix allows configuration of the Positive or Negative Overtravel inputs on an I/O module in Port 7 of the drive. After the inputs are configured in the drive firmware, if the Positive or Negative Overtravel Input is activated, the drive firmware generates a Positive or Negative Overtravel fault. When the fault occurs the drive axis coasts to a stop. This fault action is not configurable.

## Pre-charge OK Input

This feature extends the precharge input monitoring capability to the PowerFlex 755 drive in integrated motion. The event processing is as follows:

1. If the configured Pre-charge OK Input becomes inactive and the drive is in the Stopped state, the drive enters the precharge state.
2. If the configured Pre-charge OK input becomes inactive and the drive is in the Running state, the drive generates the Converter Pre-charge Input Deactivated exception and performs a Fault Coast Stop.

## Brake Output

This feature provides for the configuration of the Brake Output functionality via a relay output to the PowerFlex 755 in integrated motion only.

## Regeneration OK Input

This feature adds the Regeneration OK Input functionality to the PowerFlex 755 drive in integrated motion only.

When the drive detects the Regeneration OK Input transition to an ‘inactive’ state, the drive generates the Regeneration Power-supply Failure exception and coasts to a stop, if in motion. The exception cannot be configured and is assigned Stop Drive only.

## Contactor Enable Output

A Contactor Enable Output can be configured in the PowerFlex 755 drive in integrated motion only. The operation of this output is tied to fault processing in the drive. The drive de-energizes the Contactor Enable Output when an exception causes the axis to go to the ‘shut down’ state.

Note: This configuration is only valid when an auxiliary power supply is used for control power with frames 1...7 drives or when a 24 auxiliary power supply is used on frames 8...10 drives.

## Analog Input and Output

This feature requires the drive firmware to map analog inputs and outputs on configured I/O modules (installed in Port 7) for use in Studio 5000 Logix Designer® by using the existing attributes. Access to the analog data is available by selecting the attributes in the Axis Properties - Drive Parameters tab of the axis.

The PowerFlex 755 drive has two Analog Outputs that are available for use.

## Digital Input and Output

This feature requires the drive firmware to map digital inputs and outputs on configured I/O modules (installed in Port 7) for use in Studio 5000 Logix Designer® by using existing attributes. Access to the digital data is available by selecting the attributes in the Axis Properties - Drive Parameters tab of the axis.

## Motor Thermostat Input

Motor thermostat input functionality is provided through the motor thermostat input (PTC) on the 22-Series I/O modules (installed in Port 7) when in Integrated Motion on EtherNet/IP mode.

The functionality is the same as the motor thermostat functionality in parameter mode. When the PTC input resistance transitions from low to high at the design temperature, the drive issues a motor over temperature fault, 18 [Motor PTC Trip].

The functionality supports the current motor thermostat range for status trip and reset in parameter mode. However, this functionality is not suitable for Allen-Bradley® MPL and MPM motors due to the varying hardware capacities and thermostat ranges of the Kinetix and 22-Series I/O modules.

## SSI Rotary Full Digital Feedback

---

**IMPORTANT** See Knowledgebase, [article 745654](#), before using this functionality.

---

Integrated motion supports SSI Rotary Full Digital Feedback types. The drive also supports these feedback devices that are connected to the Universal Feedback module (20-750-UFB-1) in parameter mode. This feedback type can now be configured for use with the PowerFlex 755 drive in integrated motion. Configuration of the new feedback type is accessible from the Axis Properties - Feedback tab.

## 24-bit Device Feedback Configuration

The PowerFlex 755 drive supports 24-bit resolution configuration for the following feedback types in parameter mode:

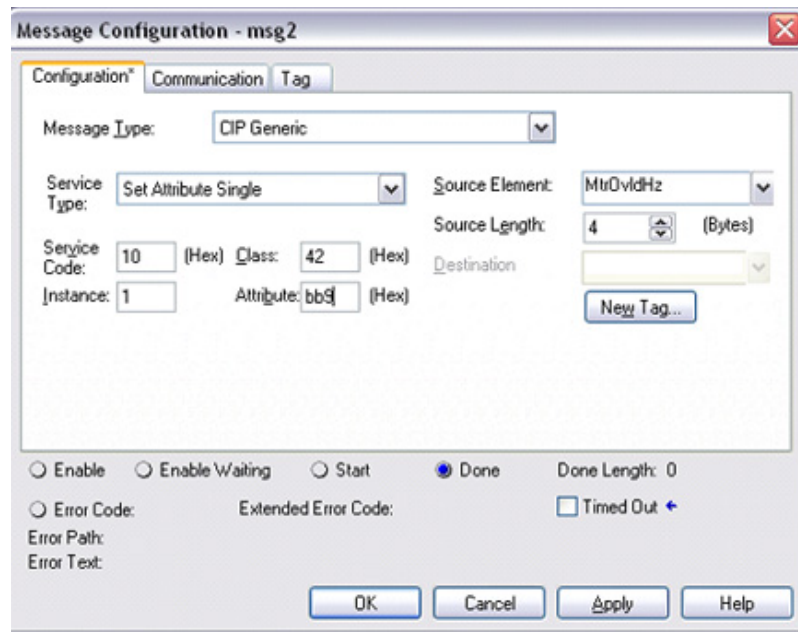
- Sine/Cosine (rotary and linear)
- Hiperface (rotary only)
- EnDat Sine/Cosine (rotary only)
- EnDat Digital (rotary only)
- SSI SC (rotary only)

The feature allows these feedback types to be configured for 24-bit effective resolution in integration motion mode. The 24-bit effective resolution configuration is accessible from the Axis Properties - Feedback tab.

## Enhanced Attributes

Enhanced attributes are accessed via an MSG instruction in RSLogix 5000. These values are the same for all enhanced attribute writes. Only the Attribute number and Source Element changes.

**IMPORTANT** Execute message commands each time the Integrated Motion on the EtherNet/IP network connection is established. Message commands are necessary because the controller defaults all drive parameters when it establishes the Integrated Motion on the EtherNet/IP network connection.



- Message Type - Choose CIP Generic.
- Service Type or Service Code - Choose the source or enter the hex value for the service that is performed on the specified object. 10 (hex) for Set Attribute Single, or 0E (hex) for Get Attribute Single.
- Class - Enter the hex value for the type or class of object to which the service is sent. 42 (hex) for Motion Device Axis Object.
- Instance - Enter the instance of the object to which the service is sent. Always a 1 for drive instance.
- Attribute - Enter the hex value of the attribute of the object to which the service is sent.
- Source Element Pull-down Menu - Choose a local source tag that contains more service parameters and/or data that is sent with the set request. For a get request, this field appears dimmed.
- Source Length - Enter or choose the number of bytes of data from the source tag that is included with the set request. For a get request, this field appears dimmed.
- Destination Pull-down Menu - Choose a local destination tag to receive the result of a get request. For a set request, this field is appears dimmed.



## Drive Parameter / Enhanced Attribute Mapping

**Table 33 - PowerFlex 755 Drive Parameter Numeric Order**

Drive		Integrated Motion			
Parameter No.	Parameter Name	Base 10	Base 16	Enhanced Attribute	Data Type
38	PWM Frequency	604	25C	PWM Frequency	Real
40, Bit 3	Mtr Option Cfg/Encls Trq Prov	2723	AA3	Encoderless Torque Prove	SINT
40, Bit 10	Mtr Options Cfg	2740	AB4	Motor Options Cfg, DB While Stop	SINT
64	SVC Boost Filter	3000	BB8	SVC Boost Filter	Real
80	PM Cfg	2600	A28	PM Test Cfg	INT
83	PM OfstTst Cur	3004	BBC	PM OfstTst Cur	Real
91	PM Vqs Reg Kp	3005	BBD	PM Vqs Reg Kp	Real
92	PM Vqs Reg Ki	3006	BBE	PM Vqs Reg Ki	Real
93	PM Dir Test Cur	3003	BBB	PM Dir Test Cur	Real
95	VCL Cur Reg BW	554	22A	kQP	Real
96	VCL Cur Reg Kp	2685	A7D	VCL Cur Reg Kp	Real
97	VCL Cur Reg Ki	2686	A7E	VCL Cur Reg Ki	Real
98	VEncdls FReg Kp	2687	A7F	VEncdls FReg Kp	Real
99	VEncdls FReg Ki	2688	A80	VEncdls FReg Ki	Real
100	Slip Reg Enable	2689	A81	Slip Reg Enable	Real
101	Slip Reg Ki	2602	A2A	Slip Reg Ki	Real
102	Slip Reg Kp	2603	A2B	Slip Reg Kp	Real
103	Flux Reg Enable	2690	A82	Flux Reg Enable	DINT
104	Flux Reg Ki	2691	A83	Flux Reg Ki	Real
105	Flux Reg Kp	2692	A84	Flux Reg Kp	Real
106	Trq Adapt Speed	2693	A85	Trq Adapt Speed	Real
107	Trq Adapt En	2694	A86	Trq Adapt En	DINT
108	Phase Delay Comp	2695	A87	Phase Delay Comp	Real
109	Trq Comp Mode	2696	A88	Trq Comp Mode	DINT
110	Trq Comp Mtring	2697	A89	Trq Comp Mtring	Real
111	Trq Comp Regen	2698	A8A	Trq Comp Regen	Real
112	Slip Adapt Iqs	2699	A8B	Slip Adapt Iqs	Real
113	SFAdapt SlewLmt	2700	A8C	SFAdapt SlewLmt	Real
114	SFAdapt SlewRate	2701	A8D	SFAdapt SlewRate	Real
115	SFAdapt CnvrngLvl	2702	A8E	SFAdapt CnvrngLvl	Real
116	SFAdapt CnvrngLmt	2703	A8F	SFAdapt CnvrngLmt	Real
321	Prchrg Control	2619	A3B	Prchrg Control	DINT
322	Prchrg Delay	2620	A3C	Prchrg Delay	Real
357	FS Gain	2604	A2C	FS Gain	Real
358	FS Ki	2605	A2D	FS Ki	Real
376	Bus Limit Kp	2606	A2E	Bus Limit Kp	Real
377	Bus Limit Kd	2607	A2F	Bus Limit Kd	Real
380	Bus Reg Ki	2608	A30	Bus Reg Ki	Real
381	Bus Reg Kp	2609	A31	Bus Reg Kp	Real
390	Flux Braking Ki	2610	A32	Flux Braking Ki	Real

Drive		Integrated Motion			
Parameter No.	Parameter Name	Base 10	Base 16	Enhanced Attribute	Data Type
391	Flux Braking Kp	2611	A33	Flux Braking Kp	Real
396	DC Brake Ki	2612	A34	DC Brake Ki	Real
397	DC Brake Kp	2613	A35	DC Brake Kp	Real
400	Fast Braking Ki	2614	A36	Fast Braking Ki	Real
401	Fast Braking Kp	2615	A37	Fast Braking Kp	Real
414	Mtr OL Hertz	3001	BB9	Motor Overload Hertz	Real
428	Current Limit Kd	2616	A38	Current Limit Kd	Real
429	Current Limit Ki	2617	A39	Current Limit Ki	Real
430	Current Limit Kp	2618	A3A	Current Limit Kp	Real
467	Ground Warn Lvl	3002	BBA	Converter Ground Current User Limit	Real
469	PredMaint Sts	2625	A41	PredMaint Sts	INT
470	PredMaintAmbTemp	2626	A42	PredMaintAmbTemp	Real
471	PredMaint Rst En	2627	A43	PredMaint Rst En	DINT
472	PredMaint Reset	2628	A44	PredMaint Reset	DINT
488	HSFan Derate	2629	A45	HSFan Derate	Real
489	HSFan TotalLife	2630	A46	HSFan TotalLife	DINT
490	HSFan ElpsdLife	2631	A47	HSFan ElpsdLife	DINT
491	HSFan RemainLife	2632	A48	HSFan RemainLife	DINT
492	HSFan EventLevel	2633	A49	HSFan EventLevel	Real
493	HSFan EventActn	2634	A4A	HSFan EventActn	DINT
494	HSFan ResetLog	2635	A4B	HSFan ResetLog	DINT
495	InFan Derate	2636	A4C	InFan Derate	Real
496	InFan TotalLife	2637	A4D	InFan TotalLife	DINT
497	InFan ElpsdLife	2638	A4E	InFan ElpsdLife	DINT
498	InFan RemainLife	2639	A4F	InFan RemainLife	DINT
499	InFan EventLevel	2640	A50	InFan EventLevel	Real
500	InFan EventActn	2641	A51	InFan EventActn	DINT
501	InFan ResetLog	2642	A52	InFan ResetLog	DINT
502	MtrBrngTotalLife	2643	A53	MtrBrngTotalLife	DINT
503	MtrBrngElpsdLife	2644	A54	MtrBrngElpsdLife	DINT
504	MtrBrngRemainLif	2645	A55	MtrBrngRemainLif	DINT
505	MtrBrngEventLvl	2646	A56	MtrBrngEventLvl	Real
506	MtrBrngEventActn	2647	A57	MtrBrngEventActn	DINT
507	MtrBrng ResetLog	2648	A58	MtrBrng ResetLog	DINT
508	MtrLubeElpsdHrs	2649	A59	MtrLubeElpsdHrs	DINT
509	MtrLubeEventLvl	2650	A5A	MtrLubeEventLvl	Real
510	MtrLubeEventActn	2651	A5B	MtrLubeEventActn	DINT
511	MchBrngTotalLife	2652	A5C	MchBrngTotalLife	DINT
512	MchBrngElpsdLife	2653	A5D	MchBrngElpsdLife	DINT
513	MchBrngRemainLif	2654	A5E	MchBrngRemainLif	DINT
514	MchBrngEventLvl	2655	A5F	MchBrngEventLvl	Real
515	MchBrngEventActn	2656	A60	MchBrngEventActn	DINT
516	MchBrngResetLog	2657	A61	MchBrngResetLog	DINT
517	MchLubeElpsdHrs	5658	A62	MchLubeElpsdHrs	DINT

Drive		Integrated Motion			
Parameter No.	Parameter Name	Base 10	Base 16	Enhanced Attribute	Data Type
518	MchLube EventLvl	2659	A63	MchLube EventLvl	Real
519	MchLubeEventActn	2660	A64	MchLubeEventActn	DINT
642	Servo Lock Gain	2721	AA1	Servo Lock Gain	Real
665	Speed Comp Sel	2621	A3D	Speed Comp Sel	DINT
676	Trq Ref A Stpt	2728	AA8	Trq Ref A Stpt	Real
681	Trq Ref B Stpt	2729	AA9	Trq Ref B Stpt	Real
832	Psn Out Fltr Sel	2622	A3E	Psn Out Fltr Sel	DINT
833	Psn Out FltrGain	2623	A3F	Psn Out FltrGain	Real
834	Psn Out Fltr BW	2624	A40	Psn Out Fltr BW	Real
935	Drive Status 1	2741	AB5	Drive Status 1	DINT
970	Testpoint Sel 1	2661	A65	Testpoint Sel 1	DINT
971	Testpoint Fval 1	2662	A66	Testpoint Fval 1	Real
972	Testpoint Lval 1	2663	A67	Testpoint Lval 1	DINT
974	Testpoint Sel 2	2664	A68	Testpoint Sel 2	DINT
975	Testpoint Fval 2	2665	A69	Testpoint Fval 2	Real
976	Testpoint Lval 2	2666	A6A	Testpoint Lval 2	DINT
978	Testpoint Sel 3	2667	A6B	Testpoint Sel 3	DINT
979	Testpoint Fval 3	2668	A6C	Testpoint Fval 3	Real
980	Testpoint Lval 3	2669	A6D	Testpoint Lval 3	DINT
982	Testpoint Sel 4	2670	A6F	Testpoint Sel 4	DINT
983	Testpoint Fval 4	2671	A6F	Testpoint Fval 4	Real
984	Testpoint Lval 4	2672	A70	Testpoint Lval 4	DINT
1035	PkDtct Stpt Real	2673	A71	PkDtct Stpt Real	Real
1036	PkDtct Stpt DInt	2674	A72	PkDtct Stpt DInt	DINT
1037	PkDtct1 In Sel	2675	A73	PkDtct1 In Sel	DINT
1038	PkDtct1PresetSel	2676	A74	PkDtct1PresetSel	DINT
1039	Peak1 Cfg	2677	A75	Peak1 Cfg	INT
1040	Peak 1 Change	2678	A76	Peak 1 Change	INT
1041	PeakDetect1 Out	2679	A77	PeakDetect1 Out	Real
1042	PkDtct2 In Sel	2680	A78	PkDtct2 In Sel	DINT
1043	PkDtct2PresetSel	2681	A79	PkDtct2PresetSel	DINT
1044	Peak2 Cfg	2682	A7A	Peak2 Cfg	INT
1045	Peak 2 Change	2683	A7B	Peak 2 Change	INT
1046	PeakDetect2 Out	2684	A7C	PeakDetect2 Out	Real
1100, Bit 3	Trq Prove Cfg / Preload	2727	AA7	Trq Prove Cfg / Preload	SINT
1100, Bit 4	Trq Prove Cfg / FW Load Limit	2731	AAB	Trq Prove Cfg / FW Load Limit	SINT
1100, Bit 10	Trq Prove Cfg / BrkSlpFltCfg	2730	AAA	Trq Prove Cfg / BrkSlpFltCfg	SINT
1103	Trq Prove Status	2722	AA2	Trq Prove Status	INT
1105	Speed Dev Band	2724	AA4	Speed Dev Band	Real
1106	SpdBand Intgrtr	2725	AA5	SpdBand Intgrtr	Real
1535	VB Config	2704	A90	VB Config	INT
1536	VB Status	2705	A91	VB Status	INT

Drive		Integrated Motion			
Parameter No.	Parameter Name	Base 10	Base 16	Enhanced Attribute	Data Type
1537	VB Voltage	2706	A92	VB Voltage	Real
1538	VB Time	2707	A93	VB Time	Real
1539	VB Minimum	2708	A94	VB Minimum	Real
1540	VB Maximum	2709	A95	VB Maximum	Real
1541	VB Accel Rate	2710	A96	VB Accel Rate	Real
1542	VB Decel Rate	2711	A97	VB Decel Rate	Real
1543	VB Frequency	2712	A98	VB Frequency	Real
1544	VB Min Freq	2713	A99	VB Min Freq	Real
1545	VB Flux Thresh	2714	A9A	VB Flux Thresh	Real
1546	VB Flux Lag Freq	2715	A9B	VB Flux Lag Freq	Real
1547	VB Filt Flux Cur	2716	A9C	VB Filt Flux Cur	Real
1548	VB Current Rate	2717	A9D	VB Current Rate	Real
1549	VB Current Hyst	2718	A9E	VB Current Hyst	Real
1550	VB Cur Thresh	2719	A9F	VB Cur Thresh	Real
1551	VB Rate Lag Freq	2720	AA0	VB Rate Lag Freq	Real

### Inverter Parameter / Enhanced Attribute Mapping

Table 34 - PowerFlex 755 Inverter Parameter Numeric Order

Drive		Integrated Motion			
Parameter No.	Parameter Name	Base 10	Base 16	Enhanced Attribute	Data Type
1	Sys Rated Amps	2855	B27	Sys Rated Amps	Real
2	Sys Rated Volts	2856	B28	Sys Rated Volts	Real
3	I1 Rated Amps	2857	B29	Ix1 Rated Amps	Real
4	I2 Rated Amps	2858	B2A	Ix2 Rated Amps	Real
5	I3 Rated Amps	2859	B2B	Ix3 Rated Amps	Real
10	Online Status	2862	B2E	Online Status	INT
12	Fault Status	2863	B2F	Fault Status	INT
13	Alarm Status	2864	B30	Alarm Status	INT
18	Ground Current	2865	B31	Ground Current	Real
20	Recfg Acknowledg	2866	B32	Recfg Acknowledg	DINT
21	Effctv I Rating	2867	B33	Effctv I Rating	Real
30	Testpoint Sel 1	2868	B34	Testpoint Sel 1	DINT
31	Testpoint Val 1	2869	B35	Testpoint Val 1	Real
32	Testpoint Sel 2	2870	B36	Testpoint Sel 2	DINT
33	Testpoint Val 2	2871	B37	Testpoint Val 2	Real

## Converter Parameter / Enhanced Attribute Mapping

**Table 35 - PowerFlex 755 Converter Parameter Numeric Order**

Drive		Integrated Motion			
Parameter No.	Parameter Name	Base 10	Base 16	Enhanced Attribute	Data Type
1	Sys Rated Amps	2905	B59	Sys Rated Amps	Real
2	Sys Rated Volts	2906	B5A	Sys Rated Volts	Real
3	C1 Rated Amps	2907	B5B	CX1 Rated Amps	Real
4	C2 Rated Amps	2908	B5C	CX2 Rated Amps	Real
5	C3 Rated Amps	2909	B5D	CX3 Rated Amps	Real
10	Online Status	2912	B60	Online Status	INT
12	Fault Status	2913	B61	Fault Status	INT
13	Alarm Status	2914	B62	Alarm Status	INT
25	Gate Board Temp	2916	B64	Gate Board Temp	Real
30	Testpoint Sel 1	2917	B65	Testpoint Sel 1	DINT
31	Testpoint Val 1	2918	B66	Testpoint Val 1	Real
32	Testpoint Sel 2	2919	B67	Testpoint Sel 2	DINT
33	Testpoint Val 2	2920	B68	Testpoint Val 2	Real

## Precharge Parameter / Enhanced Attribute Mapping

**Table 36 - PowerFlex 755 Common Bus Precharge Parameter Numeric Order**

Drive		Integrated Motion			
Parameter No.	Parameter Name	Base 10	Base 16	Enhanced Attribute	Data Type
1	Sys Rated Amps	2955	B8B	Sys Rated Amps	Real
2	Sys Rated Volts	2956	B8C	Sys Rated Volts	Real
3	P1 Rated Amps	2957	B8D	PX1 Rated Amps	Real
4	P2 Rated Amps	2958	B8E	PX2 Rated Amps	Real
5	P3 Rated Amps	2959	B8F	PX3 Rated Amps	Real
10	Online Status	2962	B92	Online Status	INT
12	Fault Status	2963	B93	Fault Status	INT
13	Alarm Status	2964	B94	Alarm Status	INT
18	Main DC Bus Volt	2965	B95	Main DC Bus Volt	Real
25	Gate Board Temp	2966	B96	Gate Board Temp	Real
30	Testpoint Sel 1	2967	B97	Testpoint Sel 1	DINT
31	Testpoint Val 1	2968	B98	Testpoint Val 1	Real
32	Testpoint Sel 2	2969	B99	Testpoint Sel 2	DINT
33	Testpoint Val 2	2970	B9A	Testpoint Val 2	Real

## Encoder Parameter / Enhanced Attribute Mapping

**Table 37 - Universal Feedback Encoder Module Output Parameter Numeric Order**

Drive		Integrated Motion			
Parameter No.	Parameter Name	Base 10	Base 16	Enhanced Attribute	Data Type
80	Enc Out Sel	2800	AF0	Enc Out Sel	DINT
81	Enc Out Mode	2801	AF1	Enc Out Mode	DINT
82	Enc Out FD PPR	2802	AF2	Enc Out FD PPR	DINT
83	Enc Out Z Offset	2803	AF3	Enc Out Z Offset	DINT
84	Enc Out Z PPR	2804	AF4	Enc Out Z PPR	DINT
20, Bit 4	FB0 SSI Cfg	2805	AF5	FB0 SSI Cfg, Double Word Query	SINT
50, Bit 4	FB1 SSI Cfg	2806	AF6	FB1 SSI Cfg, Double Word Query	SINT

## I/O Parameters

Table 38 - I/O Parameter Numeric Order

Drive		Integrated Motion			
Parameter No.	Parameter Name	Base 10	Base 16	Enhanced Attribute	Data Type
70	Anlg Out Type	2820	B04	Anlg Out Type	DINT

## Faults

[Table](#) shows the correlation between PowerFlex 755 faults and the respective faults that are returned to the Logix controller and RSLogix 5000 software. The returned fault numbers and text are common with the Kinetix 6500.

Note: A fault code/message that is displayed on a HIM does not match what is returned to the Logix controller and potentially displayed on an HMI or viewed in RSLogix 5000 software.

**Table 39 - PowerFlex 755 Drive Fault Numeric Order**

PowerFlex 755 Drive		Integrated Motion on EtherNet/IP		
Event No.	Fault Text	Code	Subcode	Fault Text
0	No Entry	0	0	No Faults
2	Auxiliary Input	63	0	External Exception Input
3	Power Loss	37	0	Bus Power Loss
4	UnderVoltage	34	0	Bus Undervoltage User Limit
5	OverVoltage	35	0	Bus Overvoltage Factory Limit
7	Motor Overload	7	0	Motor Thermal Overload Factory Limit
8	Heatsink OvrTemp	11	1	Inverter Overtemperature Factory Limit
9	Trnsistr OvrTemp	11	2	Inverter Overtemperature Factory Limit
12	HW OverCurrent	10	1	Inverter Overcurrent
13	Ground Fault	16	0	Converter Ground Current Factory Limit
14	Ground Warning	17	0	Converter Ground Current User Limit
15	Load Loss	57	0	Undertorque Limit
17	Input Phase Loss	23	0	Converter AC Single Phase Loss
20	TorqPrv Spd Band	18	1	Torque Prove Failure
21	Output PhaseLoss	63	21	Product Specific
24	Decel Inhibit	19	0	Decel Override
25	OverSpeed Limit	4	0	Motor Overspeed User Limit
26	Brake Slipped	18	2	Torque Prove Failure
33	AuRsts Exhausted	63	33	Product Specific
36	SW OverCurrent	10	2	Inverter Overcurrent
38	Phase U to Gnd	24	1	Converter AC Phase Short
39	Phase V to Gnd	24	2	Converter AC Phase Short
40	Phase W to Gnd	24	3	Converter AC Phase Short
41	Phase UV Short	24	4	Converter AC Phase Short
42	Phase VW Short	24	5	Converter AC Phase Short
43	Phase WU Short	24	6	Converter AC Phase Short
44	Phase UNegToGnd	24	7	Converter AC Phase Short
45	Phase VNegToGnd	24	8	Converter AC Phase Short
46	Phase WNegToGnd	24	9	Converter AC Phase Short
48	System Defaulted	63	33	Product Specific
49	Drive Powerup	1	0	Module Reset
55	Ctrl Bd Overtemp	10	0	Control Module Overtemperature Factory Limit
61	Shear Pin 1	56	0	Overtorque Limit

**Table 39 - PowerFlex 755 Drive Fault Numeric Order (continued)**

PowerFlex 755 Drive		Integrated Motion on EtherNet/IP		
Event No.	Fault Text	Code	Subcode	Fault Text
64	Drive OverLoad	13	0	Converter Pre-charge Overload User Limit
71	Port 1 Adapter	63	71	Product Specific
72	Port 2 Adapter	63	72	Product Specific
73	Port 3 Adapter	63	73	Product Specific
74	Port 4 Adapter	63	74	Product Specific
75	Port 5 Adapter	63	75	Product Specific
76	Port 6 Adapter	63	76	Product Specific
77	IR Volts Range	21	1	Motor Test Failure
78	FluxAmpsRef Rang	21	2	Motor Test Failure
79	Excessive Load	21	3	Motor Test Failure
80	AutoTune Aborted	21	4	Motor Test Failure
81	Port 1 DPI Loss	63	81	Product Specific
82	Port 2 DPI Loss	63	82	Product Specific
83	Port 3 DPI Loss	63	83	Product Specific
84	Port 4 DPI Loss	63	84	Product Specific
85	Port 5 DPI Loss	63	85	Product Specific
86	Port 6 DPI Loss	63	86	Product Specific
87	Ixo VoltageRange	21	5	Motor Test Failure
91	Pri VelFdbk Loss	45	255	Feedback Data Loss Factory Limit
93	Hw Enable Check	63	93	Product Specific
94	Alt VelFdbk Loss	45	255	Feedback Data Loss Factory Limit
95	Aux VelFdbk Loss	45	255	Feedback Data Loss Factory Limit
96	PositionFdbkLoss	45	255	Feedback Data Loss Factory Limit
100	Parameter Chksum	3	0	Nonvolatile Memory Checksum Fault
104	Pwr Brd Checksum	15	1	Power Board
106	Incompat MCB-PB	15	3	Power Board
107	Replaced MCB-PB	22	1	Hardware Configuration
111	PwrBd Invalid ID	15	2	Power Board
112	PwrBd App MinVer	15	4	Power Board
113	Tracking DataErr	22	2	Hardware Configuration
117	PwrDn Data Chksm	17	16	Option Storage Checksum
124	App ID Changed	23	1	Firmware Change
125	Using Backup App	23	2	Firmware Change
134	Start On PowerUp	63	134	Product Specific
137	Ext Prchrg Err	23	2	Converter Pre-Charge Failure
138	Precharge Open	23	3	Converter Pre-Charge Failure
141	Autn Enc Angle	21	6	Motor Test Failure
142	Autn Spd Rstrct	21	7	Motor Test Failure
143	Autotune CurReg	21	8	Motor Test Failure
144	Autotune Inertia	21	9	Motor Test Failure
145	Autotune Travel	21	10	Motor Test Failure
169	PWM Freq Reduced	16	0	PWM Frequency Reduced



**Table 39 - PowerFlex 755 Drive Fault Numeric Order (continued)**

PowerFlex 755 Drive		Integrated Motion on EtherNet/IP		
Event No.	Fault Text	Code	Subcode	Fault Text
170	CurLimit Reduced	17	0	Current Limit Reduced
177	Profiling Active	63	177	Product Specific
178	Homing Active	63	178	Product Specific
179	Home Not Set	63	179	Product Specific
203	Port 13 Adapter	63	203	Product Specific
204	Port 14 Adapter	63	204	Product Specific
205	DPI TransportErr	63	205	Product Specific
206	RTC Battery Fail	63	206	Product Specific
210	HW En Jumper Out	2	1	GuardConfigurationFault
211	Safety Brd Fault	9	0	GuardStopInputFault
212	Safety Jmpr Out	2	2	GuardConfigurationFault
213	Safety Jumper In	2	3	GuardConfigurationFault
224	Port 4 Comm Loss	63	224	Product Specific
225	Port 5 Comm Loss	63	225	Product Specific
226	Port 6 Comm Loss	63	226	Product Specific
227	Port 7 Comm Loss	63	227	Product Specific
228	Port 8 Comm Loss	63	228	Product Specific
229	Port 9 Comm Loss	63	229	Product Specific
244	Port 4 Cfg	16	4	Illegal Option Card
245	Port 5 Cfg	16	5	Illegal Option Card
246	Port 6 Cfg	16	6	Illegal Option Card
247	Port 7 Cfg	16	7	Illegal Option Card
248	Port 8 Cfg	16	8	Illegal Option Card
249	Port 9 Cfg	16	9	Illegal Option Card
264	Port 4 Checksum	17	4	Option Storage Checksum
265	Port 5 Checksum	17	5	Option Storage Checksum
266	Port 6 Checksum	17	6	Option Storage Checksum
267	Port 7 Checksum	17	7	Option Storage Checksum
268	Port 8 Checksum	17	8	Option Storage Checksum
269	Port 9 Checksum	17	9	Option Storage Checksum
280	Comm Loss Enet	1	0	Connection failure.
281	Enet Checksum	17	13	Option Storage Checksum
282	DLX Checksum	17	14	Option Storage Checksum
290	Prev Maint Reset	20	1	Preventative Maintenance
291	HSFan Life	20	2	Preventative Maintenance
292	InFan Life	20	3	Preventative Maintenance
293	MtrBrng Life	20	4	Preventative Maintenance
294	MtrBrng Lube	20	5	Preventative Maintenance
295	MachBrng Life	20	6	Preventative Maintenance
296	MachBrng Lube	20	7	Preventative Maintenance
307	Port7InvalidCard	63	307	Product Specific
308	Port8InvalidCard	63	308	Product Specific
310	Regeneration OK	15	0	Regen Power Supply

**Table 39 - PowerFlex 755 Drive Fault Numeric Order (continued)**

PowerFlex 755 Drive		Integrated Motion on EtherNet/IP		
Event No.	Fault Text	Code	Subcode	Fault Text
315	Excess Psn Err	4	0	Excessive Position Error
318	OutCurShare PhU	63	318	Product Specific
319	OutCurShare PhV	63	319	Product Specific
320	OutCurShare PhW	63	320	Product Specific
321	HS Temp Imbal	63	321	Product Specific
324	DC Bus Mismatch	63	324	Product Specific
325	Invalid Inv Cfg	63	325	Product Specific
326	Invalid Conv Cfg	63	326	Product Specific
331	Inv1 Comm Loss	63	331	Product Specific
341	Con1 Comm Loss	63	341	Product Specific

*Encoderless Operation Errors on Configuration*

When a system is configured for encoderless operation and the program is downloaded to the processor, the axis faults with a TorqProve configuration error (TP Encls Config alarm). To clear the configuration error, you must send an Enhanced Attribute message to the drive to configure it for encoderless operation by using a “SINT” tag value of 1 sent to Attribute 2723 Dec or AA3 Hex.

Also an Enhanced Attribute message to the drive to configure the brake speed deviation to zero must be used or a configuration error occurs. Send a ‘Real’ value of 0 to Attribute 2724 Dec or AA4 Hex to set the brake speed deviation to zero.

**Additional Resources**

The following documents contain more information on how to implement Integrated Motion on EtherNet/IP with PowerFlex 755 drives.

Integrated Motion on the Ethernet/IP Network User Manual  
 Publication Number: [MOTION-UM003](#)

Integrated Motion on the Ethernet/IP Network Reference Manual  
 Publication Number: [MOTION-RM003](#)

Logix5000 Controllers Design Considerations Reference Manual  
 Publication Number: [1756-RM094](#)

## A

- Accel Time  $n$  (No. 535, 536)** 118
- Access Level (No. 301)** 86
- Active Cur Lmt (No. 424)** 103
- Active Vel Fdbk (No. 131)** 71
- Actual Home Psn (No. 737)** 143
- Actv SpTqPs Mode (No. 313)** 89
- Adapter Parameters** 21
- Adj Vltg AccTime (No. 1140)** 189
- Adj Vltg Command (No. 1139)** 189
- Adj Vltg Config (No. 1131)** 188
- Adj Vltg DecTime (No. 1141)** 189
- Adj Vltg Preset $n$  (No. 1142...1148)** 189
- Adj Vltg Ref Hi (No. 1134)** 188
- Adj Vltg Ref Lo (No. 1135)** 188
- Adj Vltg RefMult (No. 1149)** 189
- Adj Vltg Scurve (No. 1150)** 189
- Adj Vltg Select (No. 1133)** 188
- Adj Vltg Trim Hi (No. 1137)** 188
- Adj Vltg Trim Lo (No. 1138)** 188
- Adj Vltg TrimPct (No. 1151)** 189
- Adj Vltg TrimSel (No. 1136)** 188
- Adjustable Voltage Control** 188
  - Invalid Reference 330
- Adjustable Voltage Parameters** 188
- Advanced Parameter View** 28
- Alarm Information Parameters** 173, 174, 175, 176
- Alarm Status (No. 13)**
  - Converter 227, 232
  - Inverter 223
- Alarm Status A (No. 959)** 172
- Alarm Status B (No. 960)** 173
- AlarmA at Fault (No. 962)** 175
- AlarmB at Fault (No. 963)** 175
- Alarms**
  - Drive 320
  - Drive Alarm Cross Reference 337
  - Dual Incremental Encoder 361
  - I/O 359
  - Safe Speed Monitor 359
  - Single Incremental Encoder 360
  - Types 311
  - Universal Feedback Alarm Descriptions 362
- Alt Man Ref AnHi (No. 329)** 91
- Alt Man Ref AnLo (No. 330)** 91
- Alt Man Ref Sel (No. 328)** 90
- Alt Speed Reg BW (No. 648)** 128
- Alt Speed Reg Ki (No. 650)** 129
- Alt Speed Reg Kp (No. 649)** 129
- Alt Vel Fdbk Sel (No. 128)** 70
- Alt Vel FdbkFitr (No. 129)** 71
- Alt Vel Feedback (No. 130)** 71
- AltSpdErr FltrBW (No. 651)** 129
- Analog Input Mode Status** 81
- Analog Inputs Parameters** 81, 83
- Analog Outputs Parameters** 83, 84
- Anlg In Loss Sts**
  - No. 257 – Main Control Board 82
  - No. 47 – Option Module 257, 267
- Anlg In Sqrt**
  - No. 256 – Main Control Board 82
  - No. 46 – Option Module 257, 266
- Anlg In Type**
  - No. 255 – Main Control Board 81
  - No. 45 – Option Module 257, 266
- Anlg In0 Filt BW**
  - No. 266 – Main Control Board 83
  - No. 56 – Option Module 258, 268
- Anlg In0 Filt Gn**
  - No. 265 – Main Control Board 83
  - No. 55 – Option Module 258, 267
- Anlg In0 Hi**
  - No. 261 – Main Control Board 82
  - No. 51 – Option Module 258, 267
- Anlg In0 Lo**
  - No. 262 – Main Control Board 82
  - No. 52 – Option Module 258, 267
- Anlg In0 LssActn**
  - No. 263 – Main Control Board 82
  - No. 53 – Option Module 258, 267
- Anlg In0 Raw Val**
  - No. 264 – Main Control Board 83
  - No. 54 – Option Module 258, 267
- Anlg In0 Value**
  - No. 260 – Main Control Board 82
  - No. 50 – Option Module 258, 267
- Anlg In1 Filt BW (No. 66)** 268
- Anlg In1 Filt Gn (No. 65)** 268
- Anlg In1 Hi (No. 61)** 268
- Anlg In1 Lo (No. 62)** 268
- Anlg In1 LssActn (No. 63)** 268
- Anlg In1 Raw Val (No. 64)** 268
- Anlg In1 Value (No. 60)** 268
- Anlg Out Abs**
  - No. 271 – Main Control Board 83
  - No. 71 – Option Module 259, 269
- Anlg Out Type**
  - No. 270 – Main Control Board 83
  - No. 70 – Option Module 259, 269
- Anlg Out0 Data**
  - No. 277 – Main Control Board 83
  - No. 77 – Option Module 259, 269
- Anlg Out0 DataHi**
  - No. 278 – Main Control Board 83
  - No. 78 – Option Module 259, 269
- Anlg Out0 DataLo**
  - No. 279 – Main Control Board 84
  - No. 79 – Option Module 259, 269
- Anlg Out0 Hi**
  - No. 280 – Main Control Board 84
  - No. 80 – Option Module 259, 269
- Anlg Out0 Lo**
  - No. 281 – Main Control Board 84
  - No. 81 – Option Module 259, 269
- Anlg Out0 Sel**

- No. 275 – Main Control Board 83
- No. 75 – Option Module 259, 269
- Anlg Out0 Stpt**
  - No. 276 – Main Control Board 83
  - No. 76 – Option Module 259, 269
- Anlg Out0 Val**
  - No. 282 – Main Control Board 84
  - No. 82 – Option Module 260, 270
- Anlg Out1 Data (No. 87)** 270
- Anlg Out1 DataHi (No. 88)** 270
- Anlg Out1 DataLo (No. 89)** 270
- Anlg Out1 Hi (No. 90)** 270
- Anlg Out1 Lo (No. 91)** 270
- Anlg Out1 Sel (No. 85)** 270
- Anlg Out1 Stpt (No. 86)** 270
- Anlg Out1 Val (No. 92)** 270
- Application Notes** 455
- Applications Parameters** 180
- At Limit Status (No. 945)** 169
- ATEX**
  - Faults and Alarms 360
- Auto Manual Control Parameters** 90
- Auto Mask (No. 325)** 90
- Auto Retry Fault (No. 347)** 93
- Auto Rstrt Delay (No. 349)** 93
- Auto Rstrt Tries (No. 348)** 93
- AutoClrCntrDelay (No. 340)** 92
- AutoClrFlt Delay (No. 339)** 92
- AutoClrFlt Tries (No. 338)** 92
- Autotune (No. 70)** 63
- Autotune Parameters** 63
- Autotune Torque (No. 71)** 63
- Aux Vel Fdbk Sel (No. 132)** 71
- Aux Vel FdbkFltr (No. 133)** 71
- Aux Vel Feedback (No. 134)** 71

## B

- Basic Parameter View** 26
- Block Diagrams** 375
  - Control Logic (753) 404
  - Control Logic (755) 446, 447, 448, 449
  - Diagnostic Tools 453
  - Flux Vector Overview (753) 377
  - Flux Vector Overview (755) 413
  - Friction Compensation 451, 452
  - High Speed Trend Wizard 454
  - Inputs and Outputs (753) 400
  - Inputs and Outputs (755) 444
  - Inverter Overload (753) 408, 409
  - Inverter Overload (755) 450
  - MOP Control (753) 399
  - MOP Control (755) 443
  - Position Control (753) 387
  - Position Control (755) 423
  - Process Control (753) 397
  - Process Control (755) 441
  - Speed and Position Feedback (753) 379
  - Speed and Position Feedback (755) 415
  - Speed Control (753) 380
  - Speed Control (755) 416
  - Torque Control (753) 391, 392
  - Torque Control (755) 433, 434

## Boost

- Limit Alarm 330
- Position Oriented Torque 212
- Start, Acceleration, and Run 62
- Torque 211
- BOOTP (No. 36)** 240
- BOOTP Server**
  - IP Addressing 21
- Brake Off Adj *n* (No. 402, 403)** 101
- Brake Test Torq (No. 1114)** 186
- Braking**
  - Flux Braking 100
  - Parameters 97
- Break Frequency (No. 63)** 62
- Break Voltage (No. 62)** 62
- Brk Alarm Travel (No. 1109)** 185
- Brk Release Time (No. 1107)** 185
- Brk Set Time (No. 1108)** 185
- Brk Slip Count (No. 1110)** 186
- Bus Limit ACR Ki (No. 378)** 98
- Bus Limit ACR Kp (No. 379)** 98
- Bus Limit Kd (No. 377)** 98
- Bus Limit Kp (No. 376)** 98
- Bus Reg Ki (No. 380)** 98
- Bus Reg Kp (No. 381)** 98
- Bus Reg Level (No. 375)** 97
- Bus Reg Lvl Cfg (No. 374)** 97
- Bus Reg Mode *n* (No. 372, 373)** 97
- Bus Utilization (No. 42)** 59

## C

- C1 L31 Line Volt (No. 127)** 231
- C1 Testpt Val 1 (No. 141, 143)** 231
- Cascaded Config (No. 20)** 301
- CbFan Derate (No. 481)** 109
- CbFan ElpsdLife (No. 483)** 109
- CbFan EventActn (No. 486)** 110
- CbFan EventLevel (No. 485)** 110
- CbFan RemainLife (No. 484)** 110
- CbFan TotalLife (No. 482)** 109
- Clear Flt Owner (No. 923)** 159
- Cn AC Line Freq (No. 123, 223)** 230
- Cn Alarm Status1 (No. 107, 207)** 229
- Cn CbFanElpsdLif (No. 138, 238)** 231
- Cn DC Bus Volt (No. 119, 219)** 230
- Cn Fault Status1 (No. 105, 205)** 229
- Cn Fault Status2 (No. 106, 206)** 229
- Cn GateBoardTemp (No. 122, 222)** 230
- Cn Gnd Current (No. 118, 218)** 230
- Cn Heatsink Temp (No. 120, 220)** 230

- Cn L1 Phase Curr (No. 115, 215)** 230
  - Cn L12 Line Volt (No. 125, 225)** 231
  - Cn L2 Phase Curr (No. 116, 216)** 230
  - Cn L23 Line Volt (No. 126, 226)** 231
  - Cn L3 Phase Curr (No. 117, 217)** 230
  - Cn PredMainReset (No. 137, 237)** 231
  - Cn Rated Amps (No. 3, 4)** 227, 232
  - Cn SCR Temp (No. 121, 221)** 230
  - Cn Testpt Sel *n* (No. 140, 142, 240, 242)** 231
  - Cn Testpt Val 1 (No. 141, 143, 241, 243)** 231
  - Comm Flt Action (No. 54)** 242
  - Commanded SpdRef (No. 2)** 54
  - Commanded Trq (No. 4)** 54
  - Common Mode Type (No. 41)** 58
  - Common Symptoms, Troubleshooting** 369
  - Communication Control Parameters** 154, 155
  - Communications**
    - Parameters 154
    - Status Indicator LEDs 20
  - Condition Sts 1 (No. 937)** 167
  - Config Flt Code (No. 70)** 300
  - Configuration File Parameters** 86
  - Control Configuration Parameters** 87
  - Control Logic**
    - Block Diagram (753) 404
    - Block Diagram (755) 446, 447, 448, 449
  - Controller, DriveLogix** 14
  - Conventions, Manual** 11
  - Converter Actn (No. 17)** 228
  - Counts Per Unit (No. 1215)** 196
  - CRC Flt Cfg (No. 964)** 176
  - Cross Reference**
    - Faults and Alarms 337
  - Current Limit Kd (No. 428)** 103
  - Current Limit Ki (No. 429)** 103
  - Current Limit Kp (No. 430)** 104
  - Current Limit *n* (No. 422, 423)** 103
  - Current Lmt Sel (No. 421)** 103
  - Current Rate Lmt (No. 425)** 103
- D**
- Data In *nn* (No. 895...902)** 157
  - Data Out *nn* (No. 905...912)** 157
  - Day Stroke Count (No. 1205)** 194
  - DB Ext Ohms (No. 383)** 98
  - DB Ext Watts (No. 384)** 98
  - DB ExtPulseWatts (No. 385)** 99
  - DB Resistor Type (No. 382)** 98
  - DC Brake (No. 393)** 100
  - DC Brake Ki (No. 396)** 101
  - DC Brake Kp (No. 397)** 101
  - DC Brake Level (No. 394)** 100
  - DC Brake Time (No. 395)** 101
  - DC Brk Vd Fltr (No. 399)** 101
  - DC Brk Vq Fltr (No. 398)** 101
  - DC Bus Mem Reset (No. 464)** 107
  - DC Bus Memory (No. 12)** 54
  - DC Bus Volts (No. 11)** 54
  - DC Offset Ctrl (No. 1154)** 189
  - Dead Time Comp (No. 1153)** 189
  - Dec Inhibit Actn (No. 409)** 101
  - Decel Ref Speed (No. 50)** 304
  - Decel Time *n* (No. 537, 538)** 118
  - Default Parameter Settings** 318
  - Delayed Spd Ref (No. 139)** 72, 74, 100, 120, 154, 189, 213, 214, 215
  - DeviceLogix** 495
  - DI Abort Profile (No. 1220)** 198
  - DI Abort Step (No. 1219)** 197
  - DI Accel 2 (No. 179)** 75
  - DI Aux Fault (No. 157)** 73
  - DI BusReg Mode B (No. 186)** 75
  - DI Clear Fault (No. 156)** 73
  - DI Coast Stop (No. 160)** 73
  - DI Cur Lmt Stop (No. 159)** 73
  - DI Decel 2 (No. 180)** 75
  - DI Emerg OvrRide (No. 1680)** 115
  - DI Enable (No. 155)** 73
  - DI Fiber SyncEna (No. 1129)** 188
  - DI Fiber TravDis (No. 1130)** 188
  - DI Find Home (No. 732)** 142
  - DI FloatMicroPsn (No. 1102)** 185
  - DI Fwd Dec Limit (No. 197)** 76
  - DI Fwd End Limit (No. 196)** 76
  - DI Fwd Reverse (No. 162)** 73
  - DI HOA Start (No. 176)** 74
  - DI Hold Step (No. 1218)** 197
  - DI Indx Step (No. 772)** 146
  - DI Indx StepPrst (No. 774)** 146
  - DI Indx StepRev (No. 773)** 146
  - DI Jog 1 (No. 166)** 74
  - DI Jog 1 Forward (No. 167)** 74
  - DI Jog 1 Reverse (No. 168)** 74
  - DI Jog 2 (No. 169)** 74
  - DI Jog 2 Forward (No. 170)** 74
  - DI Jog 2 Reverse (No. 171)** 74
  - DI ManRef AnlgHi (No. 564)** 120
  - DI ManRef AnlgLo (No. 565)** 120
  - DI ManRef Sel (No. 563)** 120
  - DI Manual Ctrl (No. 172)** 74
  - DI MOP Dec (No. 178)** 75
  - DI MOP Inc (No. 177)** 75
  - DI NHdwr OvrTrvl (No. 201)** 77
  - DI OL Home Limit (No. 734)** 142
  - DI PCAM Start (No. 1474)** 209
  - DI PHdwr OvrTrvl (No. 200)** 77
  - DI PID Enable (No. 191)** 76
  - DI PID Hold (No. 192)** 76

- DI PID Invert (No. 194) 76
  - DI PID Reset (No. 193) 76
  - DI Prchrg Seal (No. 190) 76
  - DI Precharge (No. 189) 75
  - DI Pump Baseline (No. 1208) 194
  - DI PumpOff Disbl (No. 1206) 194
  - DI Pwr Loss (No. 188) 75
  - DI PwrLoss ModeB (No. 187) 75
  - DI Redefine Psn (No. 733) 142
  - DI Rev Dec Limit (No. 199) 77
  - DI Rev End Limit (No. 198) 77
  - DI Run (No. 163) 73
  - DI Run Forward (No. 164) 24, 73
  - DI Run Reverse (No. 165) 74
  - DI Speed Sel *n* (No. 173...175) 74
  - DI SpTqPs Sel *n* (No. 181, 182) 75
  - DI Start (No. 161) 73
  - DI Stop (No. 158) 73
  - DI Stop Mode B (No. 185) 75
  - DI StrtStep Sel $nn$  (No. 1222...1226) 198
  - DI Torque StptA (No. 195) 76
  - DI Vel Override (No. 1221) 198
  - Diagnostic Tools**
    - Block Diagram 453
  - Diagnostics Parameters** 161
  - Dig In Filt**
    - No. 223 – Main Control Board 78
    - No. 3 – Option Module 252, 262
  - Dig In Filt Mask**
    - No. 2 – Option Module 252, 262
    - No. 222 – Main Control Board 24, 78
  - Dig In Sts (No. 1)** 252, 262
  - Dig Out Invert**
    - No. 226 – Main Control Board 79
    - No. 6 – Option Module 253, 263
  - Dig Out Setpoint**
    - No. 227 – Main Control Board 79
    - No. 7 – Option Module 253, 263
  - Dig Out Sts**
    - No. 225 – Main Control Board 79
    - No. 5 – Option Module 252, 262
  - Digital In Cfg (No. 150)** 73
  - Digital In Sts (No. 220)** 78
  - Digital Input Functions Parameters** 73, 74
  - Digital Outputs Parameters** 79
  - Dir Owner (No. 922)** 158
  - Direct Position Parameters** 145
  - Direction Mode (No. 308)** 87
  - Direction Mon (No. 42)** 303
  - Direction Tol (No. 43)** 303
  - Displaying Parameters** 319
  - DL From Net  $nn$  (No. 1...16)** 240
  - DL To Net  $nn$  (No. 17...32)** 240
  - DLs Fr Peer Act (No. 77)** 244
  - DLs Fr Peer Cfg (No. 76)** 244
  - DLs From Net Act (No. 34)** 240
  - DLs To Net Act (No. 35)** 240
  - DLs To Peer Act (No. 88)** 245
  - DLs To Peer Cfg (No. 87)** 245
  - DLX Bool SP $n$  (No. 78...81)** 251
  - DLX DigIn Sts (No. 49)** 249
  - DLX DigOut Sts (No. 50)** 249
  - DLX DigOut Sts2 (No. 51)** 250
  - DLX DINT InSP $n$  (No. 98...101)** 251
  - DLX DINT OutSP $n$  (No. 102...105)** 251
  - DLX DINT SP $n$  (No. 70...77)** 251
  - DLX DIP  $nn$  (No. 33...48)** 249
  - DLX In  $nn$  (No. 17...32)** 249
  - DLX Operation (No. 53)** 250
  - DLX Out  $nn$  (No. 1...16)** 249
  - DLX Prog Cond (No. 52)** 250
  - DLX Real InSP $n$  (No. 82...89)** 251
  - DLX Real OutSP $n$  (No. 90...97)** 251
  - DLX Real SP $nn$  (No. 54...69)** 251
  - DM Input (No. 58)** 306
  - Door Out Mode (No. 74)** 306
  - Door Out Type (No. 57)** 306
  - DPI Datalinks Parameters** 157
  - DPI Logic Rslt (No. 882)** 155
  - DPI Ramp Rslt (No. 881)** 155
  - DPI Ref Rslt (No. 880)** 155
  - Drive Data Parameters** 55
  - Drive Logic Rslt (No. 879)** 155
  - Drive Memory Parameter** 91
  - Drive OL Count (No. 940)** 168
  - Drive OL Mode (No. 420)** 103
  - Drive Ramp Rslt (No. 884)** 155
  - Drive Ref Rslt (No. 883)** 155
  - Drive State** 314
  - Drive Status 1 (No. 935)** 163
  - Drive Status 2 (No. 936)** 166
  - Drive Temp C (No. 944)** 168
  - Drive Temp Pct (No. 943)** 168
  - DriveLogix Controller** 14
  - Droop Compensation Parameters** 125
  - Droop RPM at FLA (No. 620)** 125
  - Dual Incremental Encoder**
    - Faults and Alarms 361
    - Parameters 276
  - Duty Rating (No. 306)** 87
  - Dynamic Braking**
    - Parameters 98
    - Setup 97
    - Type Select 98
- E**
- Econ AccDec Ki (No. 48)** 59
  - Econ AccDec Kp (No. 49)** 59
  - Econ At Ref Ki (No. 47)** 59

**Effctv I Rating (No. 21)** 222  
**Elapsed kWh (No. 14)** 55  
**Elapsed MWH (No. 13)** 54  
**Elapsed Run Time (No. 15)** 55  
**Electronic Gear Parameters** 150  
**Elpsd Mtr kWhrs (No. 18)** 55  
**Elpsd Mtr MWHrs (No. 16)** 55  
**Elpsd Rgn kWhrs (No. 19)** 55  
**Elpsd Rgn MWHrs (No. 17)** 55  
**Emer OV Mode Sel (No. 1681)** 115  
**Emerg Prot OVRD (No. 1683)** 115  
**EmergMode Status (No. 1684)** 116  
**Enable SW Input (No. 54)** 305  
**Enc 0 Cfg (No. 1)** 276  
**Enc 0 Error Sts (No. 6)** 277  
**Enc 0 FB (No. 4)** 276  
**Enc 0 FB Lss Cfg (No. 3)** 276  
**Enc 0 PhsLss Cnt (No. 7)** 277  
**Enc 0 PPR (No. 2)** 276  
**Enc 0 QuadLssCnt (No. 8)** 277  
**Enc 0 Sts (No. 5)** 277  
**Enc 1 Cfg (No. 11)** 278  
**Enc 1 Error Sts (No. 16)** 279  
**Enc 1 FB (No. 14)** 278  
**Enc 1 FB Lss Cfg (No. 13)** 278  
**Enc 1 PhsLss Cnt (No. 17)** 279  
**Enc 1 PPR (No. 12)** 278  
**Enc 1 QuadLssCnt (No. 18)** 279  
**Enc 1 Sts (No. 15)** 279  
**Enc Out FD PPR (No. 82)** 293  
**Enc Out Mode (No. 81)** 293  
**Enc Out Sel (No. 80)** 293  
**Enc Out Z Offset (No. 83)** 293  
**Enc Out Z PPR (No. 84)** 293  
**Encdriss AngComp (No. 78)** 64  
**Encdriss VltComp (No. 79)** 64  
**Encoder Cfg (No. 1)** 273  
**Encoder Feedback (No. 4)** 273  
**Encoder PPR (No. 2)** 273  
**Encoder Status (No. 5)** 274  
**Error Status (No. 6)** 274  
**EtherNet/IP** 21  
    Parameters 240  
**Expert Parameter View** 34  
**Ext Ramped Ref (No. 700)** 134

## F

**Fast Braking Ki (No. 400)** 101  
**Fast Braking Kp (No. 401)** 101  
**Fault Amps (No. 957)** 172  
**Fault Bus Volts (No. 958)** 172  
**Fault Frequency (No. 956)** 172  
**Fault Information Parameters** 170, 171

**Fault Status**  
    No. 12 – Converter 227, 232  
    No. 12 – Inverter 222  
**Fault Status (No. 67)** 308  
**Fault Status A (No. 952)** 170  
**Fault Status B (No. 953)** 171  
**Faults**  
    ATEX 360  
    Drive 320  
    Drive Fault Cross Reference 337  
    Dual Incremental Encoder 361  
    I/O 359  
    N-1 See Manual 334  
    Rerate See Manual 334  
    Safe Speed Monitor 359  
    Single Incremental Encoder 360  
    Types 311  
    Universal Feedback Fault Descriptions 362  
**FB0 Cfg (No. 8)** 284  
**FB0 Device Sel (No. 6)** 282  
**FB0 Identify (No. 7)** 283  
**FB0 Inc Cfg (No. 16)** 286  
**FB0 Inc Sts (No. 17)** 286  
**FB0 IncAndSC PPR (No. 15)** 285  
**FB0 Lin CPR (No. 25)** 287  
**FB0 Lin Upd Rate (No. 26)** 287  
**FB0 LinStahl Sts (No. 27)** 287  
**FB0 Loss Cfg (No. 9)** 284  
**FB0 Position (No. 5)** 282  
**FB0 SSI Cfg (No. 20)** 286  
**FB0 SSI Resol (No. 21)** 287  
**FB0 SSI Turns (No. 22)** 287  
**FB0 Sts (No. 10)** 285  
**FB1 Cfg (No. 38)** 290  
**FB1 Device Sel (No. 36)** 288  
**FB1 Identify (No. 37)** 289  
**FB1 Inc Cfg (No. 46)** 291  
**FB1 Inc Sts (No. 47)** 291  
**FB1 IncAndSC PPR (No. 45)** 291  
**FB1 Lin CPR (No. 55)** 292  
**FB1 Lin Upd Rate (No. 56)** 292  
**FB1 LinStahl Sts (No. 57)** 292  
**FB1 Loss Cfg (No. 39)** 290  
**FB1 Position (No. 35)** 288  
**FB1 SSI Cfg (No. 50)** 292  
**FB1 SSI Resol (No. 51)** 292  
**FB1 SSI Turns (No. 52)** 292  
**FB1 Sts (No. 40)** 290  
**Fbk 1 Polarity (No. 30)** 302  
**Fbk 1 Resolution (No. 31)** 302  
**Fbk 1 Speed (No. 33)** 302  
**Fbk 1 Type (No. 28)** 302  
**Fbk 1 Units (No. 29)** 302  
**Fbk 1 Volt Mon (No. 32)** 302  
**Fbk 2 Polarity (No. 35)** 302  
**Fbk 2 Resolution (No. 36)** 302

- Fbk 2 Speed (No. 38)** 303
  - Fbk 2 Units (No. 34)** 302
  - Fbk 2 Volt Mon (No. 37)** 303
  - Fbk Mode (No. 27)** 302
  - Fbk Pos Tol (No. 41)** 303
  - Fbk Speed Ratio (No. 39)** 303
  - Fbk Speed Tol (No. 40)** 303
  - Fdbk Filter Cfg (No. 303)** 55
  - Fdbk Loss Cfg (No. 3)** 273
  - Feedback & I/O Parameters** 70
  - Feedback Sources**
    - Setting gains for Primary and Alternate sources 126
  - Fiber Control (No. 1120)** 187
  - Fiber Functions Parameters** 187, 188
  - Fiber Status (No. 1121)** 187
  - File Group Parameter Organization** 26
  - Filtered Spd Ref (No. 595)** 123
  - Filtered SpdFdbk (No. 640)** 127
  - Filtered Trq Ref (No. 689)** 133
  - Final Speed Ref (No. 597)** 123
  - Find Home Ramp (No. 736)** 142
  - Find Home Speed (No. 735)** 142
  - Float Tolerance (No. 1111)** 186
  - Flt Cfg DL *nn* (No. 60...75)** 244
  - Flt Cfg Logic (No. 58)** 243
  - Flt Cfg Ref (No. 59)** 243
  - Flux Braking** 100
  - Flux Braking En (No. 388)** 100
  - Flux Braking Ki (No. 390)** 100
  - Flux Braking Kp (No. 391)** 100
  - Flux Braking Lmt (No. 389)** 100
  - Flux Cur Fdbk (No. 6)** 54
  - Flux Current Ref (No. 75)** 63
  - Flux Down Ki (No. 45)** 59
  - Flux Down Kp (No. 46)** 59
  - Flux Reg Enable (No. 103)** 67
  - Flux Reg Ki (No. 104)** 67
  - Flux Reg Kp (No. 105)** 67
  - Flux Up Enable (No. 43)** 59
  - Flux Up Time (No. 44)** 59
  - Flux Vector Overview**
    - Block Diagram (753) 377
    - Block Diagram (755) 413
  - Flying Start** 95
  - FlyingStart Mode (No. 356)** 95
  - Fr Peer Addr *n* (No. 81...84)** 245
  - Fr Peer Enable (No. 85)** 245
  - Fr Peer Status (No. 86)** 245
  - Fr Peer Timeout (No. 80)** 244
  - FrctnComp Hyst (No. 1562)** 137
  - FrctnComp Mode (No. 1560)** 137
  - FrctnComp Out (No. 1567)** 138
  - FrctnComp Rated (No. 1566)** 138
  - FrctnComp Slip (No. 1565)** 138
  - FrctnComp Stick (No. 1564)** 137
  - FrctnComp Time (No. 1563)** 137
  - FrctnComp Trig (No. 1561)** 137
  - Friction Compensation**
    - Block Diagram 451, 452
    - Parameters 137
  - FS Bri Lvl (No. 365)** 96
  - FS Excitation Ki (No. 361)** 96
  - FS Excitation Kp (No. 362)** 96
  - FS Gain (No. 357)** 95
  - FS Ki (No. 358)** 95
  - FS Msrmnt CurLvl (No. 364)** 96
  - FS Reconnect Dly (No. 363)** 96
  - FS Speed Reg Ki (No. 359)** 95
  - FS Speed Reg Kp (No. 360)** 96
  - FS ZSpd Thresh (No. 367)** 96
- ## G
- Gate Board Temp (No. 25)** 228, 233
  - Gateway Cfg *n* (No. 46...49)** 241
  - Gearbox Limit (No. 1181)** 191
  - Gearbox Rating (No. 1182)** 191
  - Gearbox Ratio (No. 1183)** 191
  - Gearbox Sheave (No. 1184)** 191
  - General Precautions** 12
  - Gnd Cur Flt Lvl (No. 16)** 228
  - Ground Current (No. 18)** 223
  - Ground Fault Parameters** 108, 115
  - Ground Warn Actn (No. 466)** 108
  - Ground Warn Lvl (No. 467)** 108
  - Guard Status (No. 68)** 309
- ## H
- Heatsink Temp (No. 23)** 228
  - High Speed Trend Wizard**
    - Block Diagram 454
  - Home Decel (No. 744)** 143
  - Home Return Spd (No. 743)** 143
  - Home Torq Offset (No. 742)** 143
  - Home Trq Level (No. 741)** 143
  - Home Trq Thresh (No. 739)** 143
  - Home Trq Time (No. 740)** 143
  - Homing Cfg (No. 20)** 280
  - Homing Control (No. 731)** 142
  - Homing Status (No. 730)** 141
  - Host Parameters** 47
  - HSFan Derate (No. 488)** 110
  - HSFan ElpsdLife (No. 490)** 110
  - HSFan EventActn (No. 493)** 111
  - HSFan EventLevel (No. 492)** 111
  - HSFan RemainLife (No. 491)** 111
  - HSFan ResetLog (No. 494)** 111
  - HSFan TotalLife (No. 489)** 110



**Human Interface Module**

In Integrated Motion Applications 319

**I****I/O Modules Parameters** 47, 48, 252**IA LdObs Delay (No. 709)** 136**Id Comp Enbl (No. 1600)** 217**Id Comp Mtrng *n* (No. 1601...1611)** 217-218**Id Comp Regen *n* (No. 1613...1623)** 218-220**Id Lo FreqCur Kp (No. 431)** 104**IdCompMtrng *n* Iq (No. 1602...1612)** 217-218**IdCompRegen *n* Iq (No. 1614...1624)** 219-220**Idle Flt Action (No. 55)** 242**IGBT Temp C (No. 942)** 168**IGBT Temp Pct (No. 941)** 168**In Alarm Status (No. 107, 207)** 224**In DC Bus Volt (No. 119, 219)** 225**In Fault Status (No. 105, 205)** 224**In Gnd Current (No. 118, 218)** 225**In Heatsink Temp (No. 120, 220)** 225**In HSFan Speed (No. 124, 224)** 225**In HSFanElpsdLif (No. 128)** 226**In IGBT Temp (No. 121, 221)** 225**In InFan 1 Speed (No. 125, 225)** 225**In InFan 2 Speed (No. 126, 226)** 225**In InFanElpsdLif (No. 129, 229)** 226**In Pos Psn Band (No. 726)** 140**In Pos Psn Dwell (No. 727)** 141**In PredMainReset (No. 127, 227)** 226**In Rated Amps (No. 3, 4)** 222**In Testpt Sel *n* (No. 140, 142, 240, 242)** 226**In Testpt Val *n* (No. 141, 143, 241, 243)** 226**In U Phase Curr (No. 115, 215)** 225**In V Phase Curr (No. 116, 216)** 225**In W Phase Curr (No. 117, 217)** 225**InAdp LdObs Mode (No. 704)** 135**Inert Comp LPFBW (No. 698)** 134**InertAdptFltrBW (No. 710)** 136**Inertia Acc Gain (No. 696)** 134**Inertia Adapt BW (No. 705)** 135**Inertia Adaption Parameters** 135**Inertia Comp Out (No. 699)** 134**Inertia Compensation Parameters** 134**Inertia CompMode (No. 695)** 134**Inertia Dec Gain (No. 697)** 134**Inertia Test Lmt (No. 77)** 64**InertiaAdaptGain (No. 706)** 135**InertiaTrqAdd (No. 708)** 136**InFan Derate (No. 495)** 111**InFan ElpsdLife (No. 497)** 112**InFan EventActn (No. 500)** 112**InFan EventLevel (No. 499)** 112**InFan RemainLife (No. 498)** 112**InFan ResetLog (No. 501)** 112**InFan TotalLife (No. 496)** 111**InPhase Loss Lvl (No. 463)** 107**InPhase LossActn (No. 462)** 107**Inputs and Outputs**

Block Diagram (753) 400

Block Diagram (755) 444

**Integrated Motion**

24-bit Device Feedback 535

Analog Input 534

Analog Output 534

Brake Output 533

Contactor Enable Output 534

Digital Input 534

Digital Output 534

Motor Overload 533

Motor Thermostat Input 534

Overtravel Input 533

Pre-charge Input 533

Regeneration OK Input 534

SSI Full Rotary 535

Torque Prove 523

**Integrated Motion Applications**

HIM Restrictions 319

**Interp Control (No. 755)** 144**Interp Psn Input (No. 756)** 144**Interp Psn Out (No. 759)** 144**Interp Trq Input (No. 758)** 144**Interp Trq Out (No. 761)** 144**Interp Vel Input (No. 757)** 144**Interp Vel Out (No. 760)** 144**Interpolator Parameters** 144**Inverter Overload**

Block Diagram (753) 408, 409

Block Diagram (755) 450

**IO Diag Status (No. 69)** 310**IP Addr Cfg *n* (No. 38...41)** 241**IP Address Switches** 21**IPM AltOffstComp (No. 1647)** 66**IPM Bus Prot (No. 1629)** 69**IPM Max Cur (No. 1640)** 69**IPM PriOffstComp (No. 1646)** 66**IPM SpdEst Kp Hi (No. 1662)** 61**IPM TrqTrim HLim (No. 1644)** 69**IPM TrqTrim Ki (No. 1643)** 69**IPM TrqTrim Kp (No. 1642)** 69**IPM TrqTrim LLim (No. 1645)** 69**IPM\_Ld\_0\_pct (No. 1635)** 66**IPM\_Ld\_100\_pct (No. 1636)** 66**IPM\_Lg\_100\_pct (No. 1633)** 66**IPM\_Lg\_125\_pct (No. 1634)** 66**IPM\_Lg\_25\_pct (No. 1630)** 66**IPM\_Lg\_50\_pct (No. 1631)** 66**IPM\_Lg\_75\_pct (No. 1632)** 66**IPMVdFFwdLqLqWe (No. 1639)** 69**IPMVqFFwdCemf (No. 1637)** 69**IPMVqFFwdLldWe (No. 1638)** 69

Iq Lo FreqCur Kp (No. 432) 104  
 IR Voltage Drop (No. 73) 63  
 Ixo Voltage Drop (No. 74) 63

## J

Jerk Gain (No. 433) 104  
 Jog Acc Dec Time (No. 539) 118  
 Jog Owner (No. 921) 158  
 Jog Speed  $n$  (No. 556, 557) 119  
 Jumper J4 Analog Input Mode 81  
 Jumper Out Fault 331

## L

L1 Phase Curr (No. 20) 228  
 L2 Phase Curr (No. 21) 228  
 L3 Phase Curr (No. 22) 228  
 Language (No. 302) 86  
 Last Fault Code (No. 951) 170  
 Last StartSource (No. 931) 161  
 Last Stop Source (No. 932) 161  
 Last StrtInhibit (No. 934) 162  
 LdPsn Fdbk Div (No. 826) 151  
 LdPsn Fdbk Mult (No. 825) 151  
 LEDs 20, 314  
 Lim Speed Input (No. 52) 305  
 Limited Spd Ref (No. 593) 123  
 Limited Trq Ref (No. 690) 133  
 LimSpd Mon Delay (No. 53) 305  
 Load Estimate (No. 707) 135  
 Load Limits Parameters 103  
 Load Loss Action (No. 441) 105  
 Load Loss Level (No. 442) 105  
 Load Loss Time (No. 443) 105  
 Load Observer BW (No. 711) 136  
 Load Position Parameters 151  
 Load Psn FdbkSel (No. 136) 72  
 Lock Mon Enable (No. 59) 306  
 Lock Mon Input (No. 60) 306  
 Lock State (No. 5) 299  
 Logic Mask (No. 324) 90  
 Logic Mask Act (No. 886) 156  
 Logic Src Cfg (No. 78) 244

## M

Main DC Bus Volt (No. 18) 233  
 Manual Cmd Mask (No. 326) 90  
 Manual Conventions 11  
 Manual Owner (No. 924) 159  
 Manual Preload (No. 331) 91  
 Manual Ref Mask (No. 327) 90  
 Max Acc Stop Typ (No. 66) 307

Max Accel Enable (No. 64) 307  
 Max Fwd Speed (No. 520) 117  
 Max Rev Speed (No. 521) 117  
 Max Rod Speed (No. 1175) 191  
 Max Rod Torque (No. 1176) 191  
 Max Spd Stop Typ (No. 63) 307  
 Max Speed Enable (No. 61) 307  
 Max Stop Time (No. 47) 304  
 Max Traverse (No. 1125) 187  
 Maximum Freq (No. 37) 57  
 Maximum Voltage (No. 36) 57  
 MchBrngElpsdLife (No. 512) 114  
 MchBrngEventActn (No. 515) 114  
 MchBrngEventLvl (No. 514) 114  
 MchBrngRemainLif (No. 513) 114  
 MchBrngResetLog (No. 516) 114  
 MchBrngTotalLife (No. 511) 114  
 MchLube EventLvl (No. 518) 114  
 MchLubeElpsdHrs (No. 517) 114  
 MchLubeEventActn (No. 519) 114  
 Metering Parameters 54  
 MicroPsnScalePct (No. 1112) 186  
 Min Adj Voltage (No. 1152) 189  
 Min Fwd Speed (No. 522) 117  
 Min Rev Speed (No. 523) 117  
 Min Rod Speed (No. 1177) 191  
 Minor Flt Cfg (No. 950) 170  
 Module Err Reset (No. 2) 282  
 Module Parameters 47  
 Module Sts  
   No. 1 – Universal Feedback Module 281  
   No. 21 – Dual Incremental Encoder 280  
 Monitor Parameters 54  
 MOP Control  
   Block Diagram (753) 399  
   Block Diagram (755) 443  
 MOP High Limit (No. 561) 120  
 MOP Init Select (No. 566) 120  
 MOP Init Stpt (No. 567) 120  
 MOP Low Limit (No. 562) 120  
 MOP Rate (No. 560) 120  
 MOP Reference (No. 558) 119  
 Motor Control Parameters 56, 57, 58  
 Motor Ctrl Mode (No. 35) 57  
 Motor Data Parameters 56  
 Motor NP Amps (No. 26) 56  
 Motor NP Hertz (No. 27) 56  
 Motor NP Power (No. 30) 56  
 Motor NP RPM (No. 28) 56  
 Motor NP Volts (No. 25) 56  
 Motor OL Actn (No. 410) 102  
 Motor Overload Parameters 102, 103  
 Motor Poles (No. 31) 56  
 Motor Power Lmt (No. 427) 103

**Motor Sheave (No. 1178)** 191  
**Motor TCP Parameters** 81  
**Msg Flt Action (No. 57)** 243  
**Mtr NP Pwr Units (No. 29)** 56  
**Mtr OL Alarm Lvl (No. 412)** 102  
**Mtr OL at Pwr Up (No. 411)** 102  
**Mtr OL Counts (No. 418)** 103  
**Mtr OL Factor (No. 413)** 102  
**Mtr OL Hertz (No. 414)** 102  
**Mtr OL Reset Lvl (No. 415)** 102  
**Mtr OL Trip Time (No. 419)** 103  
**Mtr Options Cfg (No. 40)** 58  
**Mtr Vel Fdbk (No. 3)** 54  
**MtrBrng ResetLog (No. 507)** 113  
**MtrBrngElpsdLife (No. 503)** 113  
**MtrBrngEventActn (No. 506)** 113  
**MtrBrngEventLvl (No. 505)** 113  
**MtrBrngRemainLif (No. 504)** 113  
**MtrBrngTotalLife (No. 502)** 113  
**MtrLubeElpsdHrs (No. 508)** 113  
**MtrLubeEventActn (No. 510)** 113  
**MtrLubeEventLvl (No. 509)** 113  
**MtrOL Reset Time (No. 416)** 102

## N

**N-1 See Manual Fault** 334  
**Neg Torque Limit (No. 671)** 132  
**Net Addr Src (No. 37)** 240  
**Net Rate Act (No. 51)** 242  
**Net Rate Cfg (No. 50)** 241  
**New Password (No. 13)** 299  
**Notch Fltr Atten (No. 688)** 133  
**Notch Fltr Freq (No. 687)** 133

## O

**Oil Well** 191  
**OilWell Pump Cfg (No. 1179)** 191  
**Online Status**  
     No. 10 – Converter 227, 232  
     No. 10 – Inverter 222  
**Open Loop Fdbk (No. 137)** 72  
**Operating Mode (No. 6)** 299  
**Option Modules**  
     Parameter Organization 47  
**Out PhaseLossLvl (No. 445)** 105  
**OutPhaseLossActn (No. 444)** 105  
**Output Current (No. 7)** 54  
**Output Frequency (No. 1)** 54  
**Output Power (No. 9)** 54  
**Output Powr Fctr (No. 10)** 54  
**Output Voltage (No. 8)** 54  
**OverSpd Response (No. 24)** 301  
**Overspeed Limit (No. 524)** 117

**Owners Parameters** 158, 160

## P

**P Jump** 188  
**P Jump (No. 1126)** 188  
**Parameter**  
     Not Displaying 319  
**Parameter Access Level**  
     Explanation 25  
**Parameters**  
     Advanced View 28  
     Basic View 26  
     Descriptions and Programming 23, 53, 221, 239  
     DeviceLogix 497  
     Drive Applications File 180  
     Drive Communication File 154  
     Drive Configuration File 86  
     Drive Diagnostics File 161  
     Drive Feedback & I/O File 70  
     Drive Monitor File 54  
     Drive Motor Control File 56  
     Drive Position Control File 139  
     Drive Protection File 102  
     Drive Speed Control File 117  
     Dual Incremental Encoder 276  
     EtherNet/IP 240  
     Expert View 34  
     How Organized 26  
     I/O Module 252  
     I/O Modules 47, 48  
     Linear List 54  
     On Option Modules 47  
     Safe Speed Monitor Module 299  
     Setting to Factory Defaults 318  
     Single Incremental Encoder 273  
     Universal Feedback Module 281  
**Password (No. 1)** 299  
**Password Command (No. 17)** 299  
**PCAM Aux EndPnt (No. 1439)** 208  
**PCAM Aux Pt X n (No. 1441...1469)** 208  
**PCAM Aux Pt Y n (No. 1442...1470)** 208  
**PCAM Aux Types (No. 1440)** 208  
**PCAM Control (No. 1390)** 205  
**PCAM Main EndPnt (No. 1405)** 206  
**PCAM Main Pt X n (No. 1407...1437)** 207  
**PCAM Main Pt Y n (No. 1408...1438)** 207  
**PCAM Main Types (No. 1406)** 207  
**PCAM Mode (No. 1391)** 205  
**PCAM Psn Ofst (No. 1394)** 205  
**PCAM Psn Out (No. 1473)** 209  
**PCAM Psn Select (No. 1392)** 205  
**PCAM Psn Stpt (No. 1393)** 205  
**PCAM PsnOfst Eps (No. 1395)** 206  
**PCAM Scale X (No. 1397)** 206  
**PCAM ScaleY Sel (No. 1399)** 206  
**PCAM ScaleYSetPt (No. 1400)** 206  
**PCAM Slope Begin (No. 1403)** 206  
**PCAM Slope End (No. 1404)** 206

- PCAM Span X (No. 1396) 206
- PCAM Span Y (No. 1398) 206
- PCAM Status (No. 1471) 209
- PCAM Vel Out (No. 1472) 209
- PCAM VelScaleSel (No. 1401) 206
- PCAM VelScaleSP (No. 1402) 206
- PCP Pump Sheave (No. 1180) 191
- Pct Cycle Torque (No. 1198) 194
- Pct Drop Torque (No. 1200) 194
- Pct Lift Torque (No. 1199) 194
- Peak 1 Change (No. 1040) 178
- Peak 2 Change (No. 1045) 179
- Peak Detection Parameters 177
- Peak1 Cfg (No. 1039) 178
- Peak2 Cfg (No. 1044) 179
- PeakDetect1 Out (No. 1041) 178
- PeakDetect2 Out (No. 1046) 179
- Peer Flt Action (No. 56) 243
- Permanent Magnet Motors 517
  - Compatibility 513
  - Parameters 64
- Phase Delay Comp (No. 108) 68
- Phase Lock Loop Parameters 148
- Phase Loss Count (No. 7) 275
- PID Cfg (No. 1065) 180
- PID Control (No. 1066) 180
- PID Deadband (No. 1083) 182
- PID Deriv Time (No. 1088) 182
- PID Error Meter (No. 1092) 183
- PID FB Loss SpSel (No. 1075) 181
- PID FB Loss TqSel (No. 1076) 181
- PID Fdbk (No. 1077) 181
- PID Fdbk AnlgHi (No. 1073) 181
- PID Fdbk AnlgLo (No. 1074) 181
- PID Fdbk Meter (No. 1091) 183
- PID Fdbk Mult (No. 1078) 181
- PID Fdbk Sel (No. 1072) 181
- PID Int Time (No. 1087) 182
- PID Lower Limit (No. 1082) 182
- PID LP Filter BW (No. 1084) 182
- PID Output Meter (No. 1093) 183
- PID Output Mult (No. 1080) 182
- PID Output Sel (No. 1079) 182
- PID Preload (No. 1085) 182
- PID Prop Gain (No. 1086) 182
- PID Ref AnlgHi (No. 1068) 181
- PID Ref AnlgLo (No. 1069) 181
- PID Ref Meter (No. 1090) 183
- PID Ref Mult (No. 1071) 181
- PID Ref Sel (No. 1067) 180
- PID Setpoint (No. 1070) 181
- PID Status (No. 1089) 183
- PID Upper Limit (No. 1081) 182
- PkDtct Stpt DInt (No. 1036) 177
- PkDtct Stpt Real (No. 1035) 177
- PkDtct1 In Sel (No. 1037) 177
- PkDtct1PresetSel (No. 1038) 177
- PkDtct2 In Sel (No. 1042) 178
- PkDtct2PresetSel (No. 1043) 178
- PLL BW (No. 801) 149
- PLL Control (No. 795) 148
- PLL Enc Out (No. 809) 150
- PLL Enc Out Adv (No. 810) 150
- PLL EPR Input (No. 804) 149
- PLL EPR Output (No. 811) 150
- PLL Ext Spd Sel (No. 796) 148
- PLL Ext Spd Stpt (No. 797) 149
- PLL Ext SpdScale (No. 798) 149
- PLL LPFilter BW (No. 802) 149
- PLL Psn Out Fltr (No. 806) 150
- PLL Psn Ref Sel (No. 799) 149
- PLL Psn Stpt (No. 800) 149
- PLL Rvls Input (No. 805) 149
- PLL Rvls Output (No. 812) 150
- PLL Speed Out (No. 807) 150
- PLL Speed OutAdv (No. 808) 150
- PLL Virt Enc RPM (No. 803) 149
- PM AltEnc Offset (No. 82) 65
- PM CEMF Voltage (No. 86) 65
- PM Cfg (No. 80) 64
- PM Dir Test Cur (No. 93) 65
- PM IR Voltage (No. 87) 65
- PM IXd Voltage (No. 89) 65
- PM IXq Voltage (No. 88) 65
- PM IXqVoltage125 (No. 120) 66
- PM OfstTst CRamp (No. 84) 65, 66
- PM OfstTst Cur (No. 83) 65
- PM OfstTst FRamp (No. 85) 55, 65, 69
- PM PriEnc Offset (No. 81) 64
- PM Vel Max (No. 1641) 69
- PM Vqs Reg Ki (No. 92) 65
- PM Vqs Reg Kp (No. 91) 65
- Pn 240VSplyVolts (No. 112, 212) 236
- Pn Alarm Status1 (No. 107, 207) 235
- Pn Board Status (No. 104, 204) 234
- Pn CbFanElpsdLif (No. 138, 238) 236
- Pn DC Bus Volts (No. 110, 210) 236
- Pn Fault Status1 (No. 105, 205) 235
- Pn Fault Status2 (No. 106, 206) 235
- Pn GateBoardTemp (No. 122, 222) 236
- Pn Main DC Volts (No. 111, 211) 236
- Pn PredMainReset (No. 137, 237) 236
- Pn Testpt Sel *n* (No. 140, 142, 240, 242) 237
- Pn Testpt Val *n* (No. 141, 143, 241, 243) 237
- Point to Point Parameters 146
- Port Mask Act (No. 885) 156
- Port *n* Reference (No. 871...878) 155
- Port Number (No. 33) 240

- Port Verification** 369
- Pos Torque Limit (No. 670)** 132
- Position Control**
  - Block Diagram (753) 387
  - Block Diagram (755) 423
- Position Control (No. 721)** 139
- Position Control Parameters** 139
- Position Homing Parameters** 142
- Position Offset Parameters** 151
- Position Oriented Torque Boost** 212
  - Block Diagram 432
- Position Regulator Parameters** 152
- Position Watch Parameters** 144
- Power Cycling**
  - IP Address Switches 21
- Power Loss Actn (No. 449)** 106
- Power Loss Parameters** 106, 107
- PowerUp Delay (No. 346)** 93
- Prchrg Control (No. 321)** 89
- Prchrg Delay (No. 322)** 89
- Prchrg Err Cfg (No. 323)** 89
- Precautions, General** 12
- Predictive Maintenance Parameters** 109, 110, 111, 112
- PredMaint Reset (No. 472)** 109
- PredMaint Rst En (No. 471)** 109
- PredMaint Sts (No. 469)** 109
- PredMaint Sts (No. 99)** 260, 271
- PredMaintAmbTemp (No. 470)** 109
- Preferences Parameters** 86
- PReg Neg Int Lmt (No. 841)** 153
- PReg Neg Spd Lmt (No. 845)** 153
- PReg Pos Int Lmt (No. 840)** 153
- PReg Pos Spd Lmt (No. 844)** 153
- Preset Speed *n* (No. 571...577)** 120
- Pri Vel Fdbk Sel (No. 125)** 70
- Pri Vel FdbkFltr (No. 126)** 70
- Pri Vel Feedback (No. 127)** 70
- Process Control**
  - Block Diagram (753) 397
  - Block Diagram (755) 441
- Process PID Parameters** 180
- Prof DI Invert (No. 1217)** 197
- Profile Command (No. 1213)** 196
- Profile Status (No. 1210)** 195, 210, 211, 212, 215, 216, 217, 218, 219, 220
- Profiling Parameters** 195
- ProfVel Override (No. 1216)** 196
- Protection File Parameters** 102
- Psn Actual (No. 836)** 152
- Psn Command (No. 723)** 140
- Psn Direct Ref (No. 767)** 145
- Psn Direct Stpt (No. 766)** 145
- Psn EGR Div (No. 817)** 150
- Psn EGR Mult (No. 816)** 150
- Psn Error (No. 835)** 152
- Psn Fdbk (No. 847)** 154
- Psn Fdbk Sel (No. 135)** 71
- Psn Gear Ratio (No. 848)** 154
- Psn Load Actual (No. 837)** 153
- Psn Offset 1 (No. 821)** 151
- Psn Offset 1 Sel (No. 820)** 151
- Psn Offset 2 (No. 823)** 151
- Psn Offset 2 Sel (No. 822)** 151
- Psn Offset Vel (No. 824)** 151
- Psn Out Fltr BW (No. 834)** 152
- Psn Out Fltr Sel (No. 832)** 152
- Psn Out FltrGain (No. 833)** 152
- Psn Ref EGR Out (No. 815)** 150
- Psn Ref Select (No. 765)** 145
- Psn Reg Droop (No. 846)** 154
- Psn Reg Ki (No. 838)** 153
- Psn Reg Kp (No. 839)** 153
- Psn Reg Status (No. 724)** 140
- Psn Selected Ref (No. 722)** 140
- PsnNtchFltrDepth (No. 831)** 152
- PsnNtchFltrFreq (No. 830)** 152
- PsnReg IntgrlOut (No. 842)** 153
- PsnReg Spd Out (No. 843)** 153
- PsnTrqBst Ctrl (No. 1515)** 211
- PsnTrqBst Ps *Xn* (No. 1520...1524)** 212
- PsnTrqBst RefSel (No. 1517)** 212
- PsnTrqBst Sts (No. 1516)** 212
- PsnTrqBst Trq *Yn* (No. 1525...1527)** 212
- PsnTrqBst TrqOut (No. 1528)** 212
- PsnTrqBst UNWCnt (No. 1519)** 212
- PsnTrqBstPsnOfst (No. 1518)** 212
- PsnWatchn DtctlIn (No. 746, 749)** 144
- PsnWatchn Select (No. 745, 748)** 144
- PsnWatchn Stpt (No. 747, 750)** 144
- PTC Cfg (No. 250)** 81
- PTC Cfg (No. 40)** 266
- PTC Raw Value (No. 42)** 266
- PTC Status (No. 251)** 81
- PTC Sts (No. 41)** 256, 266
- PTP Accel Time (No. 781)** 147
- PTP Command (No. 784)** 147
- PTP Control (No. 770)** 146
- PTP Decel Time (No. 782)** 147
- PTP EGR Div (No. 790)** 148
- PTP EGR Mult (No. 789)** 148
- PTP Feedback (No. 777)** 147
- PTP Fwd Vel Lmt (No. 785)** 147
- PTP Index Preset (No. 779)** 147
- PTP Mode (No. 771)** 146
- PTP PsnRefStatus (No. 720)** 139
- PTP Ref Scale (No. 778)** 147
- PTP Ref Sel (No. 775)** 147
- PTP Reference (No. 776)** 147
- PTP Rev Vel Lmt (No. 786)** 148

- PTP S Curve (No. 787)** 148  
**PTP Setpoint (No. 780)** 147  
**PTP Speed FwdRef (No. 783)** 147  
**PTP Vel Override (No. 788)** 148  
**Pump Cycle Store (No. 1192)** 193  
**Pump Jack Parameters** 190  
**Pump Off Action (No. 1189)** 192  
**Pump Off Config (No. 1187)** 192  
**Pump Off Control (No. 1190)** 192  
**Pump Off Count (No. 1203)** 194  
**Pump Off Level (No. 1195)** 193  
**Pump Off Parameters** 192, 193  
**Pump Off Setup (No. 1188)** 192  
**Pump Off Speed (No. 1196)** 194  
**Pump Off Status (No. 1191)** 193  
**Pump Off Time (No. 1197)** 194  
**Pump OffSleepLvl (No. 1207)** 194  
**PumpOff SleepCnt (No. 1204)** 194  
**Purge Frequency (No. 1682)** 115  
**PWM Frequency (No. 38)** 57  
**Pwr Loss Mode *n* (No. 450, 453)** 106  
**Pwr Loss *n* Level (No. 451, 454)** 106  
**Pwr Loss *n* Time (No. 452, 455)** 106  
**PwrLoss RT ACRKi (No. 459)** 106  
**PwrLoss RT ACRKp (No. 458)** 106  
**PwrLoss RT BusKd (No. 457)** 106  
**PwrLoss RT BusKp (No. 456)** 106
- Q**
- Quad Loss Count (No. 8)** 275
- R**
- Ramped Spd Ref (No. 594)** 123  
**Rated Amps (No. 21)** 55  
**Rated kW (No. 22)** 55  
**Rated Volts (No. 20)** 55  
**Recfg Acknowledg (No. 20)** 223  
**Ref Select Owner (No. 925)** 159  
**Ref Src Cfg (No. 79)** 244  
**Regen Power Lmt (No. 426)** 103  
**Registration Parameters** 295  
**Regulator Parameters** 67  
**Relay Output Parameters** 85  
**Rerate See Manual Fault** 334  
**Reset Defaults (No. 7)** 299  
**Reset Meters (No. 336)** 91  
**Reset Parameter Defaults** 318  
**Reset Type (No. 22)** 301  
**Rgsn Arm (No. 90)** 293  
**Rgsn Hmln Filter (No. 93)** 294  
**Rgsn In 0 Filter (No. 91)** 294  
**Rgsn In 1 Filter (No. 92)** 294  
**Rgsn Latchn Cfg (No. 100...127)** 295  
**Rgsn Latchn Psn (No. 101...128)** 298  
**Rgsn Latchn Time (No. 102...129)** 298  
**Rgsn Sts (No. 94)** 295  
**RO PredMaint Sts (No. 285)** 85  
**RO0 ElapsedLife**  
     No. 103 – Option Module 260, 271  
     No. 289 – Main Control Board 85  
**RO0 Level**  
     No. 12 – Option Module 253, 263  
     No. 232 – Main Control Board 79  
**RO0 Level CmpSts**  
     No. 13 – Option Module 253, 263  
     No. 233 – Main Control Board 80  
**RO0 Level Sel**  
     No. 11 – Option Module 253, 263  
     No. 231 – Main Control Board 79  
**RO0 LifeEvtActn**  
     No. 106 – Option Module 261, 271  
     No. 292 – Main Control Board 85  
**RO0 LifeEvtLvl**  
     No. 105 – Option Module 260, 271  
     No. 291 – Main Control Board 85  
**RO0 Load Amps**  
     No. 101 – Option Module 260, 271  
     No. 287 – Main Control Board 85  
**RO0 Load Type**  
     No. 100 – Option Module 260, 271  
     No. 286 – Main Control Board 85  
**RO0 Off Time**  
     No. 15 – Option Module 254, 264  
     No. 235 – Main Control Board 80  
**RO0 On Time**  
     No. 14 – Option Module 254, 264  
     No. 234 – Main Control Board 80  
**RO0 RemainLife**  
     No. 104 – Option Module 260, 271  
     No. 290 – Main Control Board 85  
**RO0 Sel**  
     No. 10 – Option Module 253, 263  
     No. 230 – Main Control Board 79  
**RO0 TotalLife**  
     No. 102 – Option Module 260, 271  
     No. 288 – Main Control Board 85  
**R01 ElapsedLife (No. 113)** 261, 272  
**R01 Level (No. 22)** 254, 264  
**R01 Level CmpSts (No. 23)** 254, 264  
**R01 Level Sel (No. 21)** 254, 264  
**R01 LifeEvtActn (No. 116)** 261, 272  
**R01 LifeEvtLvl (No. 115)** 261, 272  
**R01 Load Amps (No. 111)** 261, 272  
**R01 Load Type (No. 110)** 261, 272  
**R01 Off Time (No. 25)** 255, 265  
**R01 On Time (No. 24)** 254, 264  
**R01 RemainLife (No. 114)** 261, 272  
**R01 Sel (No. 20)** 254, 264  
**R01 TotalLife (No. 112)** 261, 272  
**Rod Speed (No. 1165)** 190

**Rod Speed Cmd (No. 1167)** 190  
**Rod Torque (No. 1166)** 190  
**Roll Position Indicator** 210  
     Block Diagram 430, 431  
**Roll Psn Config (No. 1500)** 210  
**Roll Psn Offset (No. 1505)** 210  
**Roll Psn Preset (No. 1504)** 210  
**Roll Psn Status (No. 1501)** 210  
**RP EPR Input (No. 1506)** 210  
**RP Psn Fdbk Sel (No. 1503)** 210  
**RP Psn Fdbk Stpt (No. 1502)** 210  
**RP Psn Output (No. 1511)** 211  
**RP Rvls Input (No. 1507)** 211  
**RP Rvls Output (No. 1508)** 211  
**RP Unit Out (No. 1512)** 211  
**RP Unit Scale (No. 1510)** 211  
**RP Unwind (No. 1509)** 211  
**Rstrt Cntr Delay (No. 343)** 92  
**Run Boost (No. 61)** 62

## S

**S Curve Accel (No. 540)** 118  
**S Curve Decel (No. 541)** 118  
**Safe Accel Limit (No. 65)** 307  
**Safe Max Speed (No. 62)** 307  
**Safe Speed Limit (No. 55)** 305  
**Safe Speed Monitor**  
     Module Status 280  
     Parameters 299  
**Safe Stop Input (No. 44)** 304  
**Safe Stop Type (No. 45)** 304  
**Safety Mode (No. 21)** 301  
**Safety Port Sts (No. 946)** 169  
**Save MOP Ref (No. 559)** 120  
**ScaleBlk Int 00 (No. 1902)** 160  
**ScaleBlk Int 01 (No. 1906)** 160  
**ScaleBlk Int 02 (No. 1910)** 160  
**ScaleBlk Int 03 (No. 1914)** 160  
**ScaleBlk Int 04 (No. 1918)** 160  
**ScaleBlk Int 05 (No. 1922)** 160  
**ScaleBlk Int 06 (No. 1926)** 160  
**ScaleBlk Int 07 (No. 1930)** 160  
**ScaleBlk Real 00 (No. 1903)** 160  
**ScaleBlk Real 01 (No. 1907)** 160  
**ScaleBlk Real 02 (No. 1911)** 160  
**ScaleBlk Real 03 (No. 1915)** 160  
**ScaleBlk Real 04 (No. 1919)** 160  
**ScaleBlk Real 05 (No. 1923)** 160  
**ScaleBlk Real 06 (No. 1927)** 160  
**ScaleBlk Real 07 (No. 1931)** 160  
**ScaleBlk Scal 00 (No. 1901)** 160  
**ScaleBlk Scal 01 (No. 1905)** 160  
**ScaleBlk Scal 02 (No. 1909)** 160  
**ScaleBlk Scal 03 (No. 1913)** 160  
**ScaleBlk Scal 04 (No. 1917)** 160  
**ScaleBlk Scal 05 (No. 1921)** 160  
**ScaleBlk Scal 06 (No. 1925)** 160  
**ScaleBlk Scal 07 (No. 1929)** 160  
**ScaleBlk Sel 00 (No. 1900)** 160  
**ScaleBlk Sel 01 (No. 1904)** 160  
**ScaleBlk Sel 02 (No. 1908)** 160  
**ScaleBlk Sel 03 (No. 1912)** 160  
**ScaleBlk Sel 04 (No. 1916)** 160  
**ScaleBlk Sel 05 (No. 1920)** 160  
**ScaleBlk Sel 06 (No. 1924)** 160  
**ScaleBlk Sel 07 (No. 1928)** 160  
**SCR Temp (No. 24)** 228  
**Security Code (No. 18)** 299  
**Security Parameters** 156  
**Selected Spd Ref (No. 592)** 123  
**Selected Trq Ref (No. 685)** 133  
**Servo Lock Gain (No. 642)** 127  
**Servo Motors** 513, 517  
**Set Top of Stroke (No. 1193)** 193  
**SFAdapt CnvrqLmt (No. 116)** 69  
**SFAdapt CnvrqLvl (No. 115)** 68  
**SFAdapt SlewLmt (No. 113)** 68  
**SFAdapt SlewRate (No. 114)** 68  
**Shear Pin Cfg (No. 434)** 104  
**Shear Pin *n* Actn (No. 435, 438)** 104  
**Shear Pin *n* Time (No. 437, 440)** 104  
**Shear Pin<sub>*n*</sub> Level (No. 436, 439)** 104  
**Signature ID (No. 10)** 299  
**Simulator Fdbk (No. 138)** 72  
**Single Incremental Encoder**  
     Faults and Alarms 360  
     Parameters 273  
**Single-Phase Output Configuration** 188  
**Skip Speed Band (No. 529)** 118  
**Skip Speed *n* (No. 526...528)** 118  
**SLAT Dwell Time (No. 315)** 89  
**SLAT Err Stpt (No. 314)** 89  
**Sleep Level (No. 352)** 95  
**Sleep Time (No. 353)** 95  
**Sleep Wake** 94  
**Sleep Wake Mode (No. 350)** 94  
**SleepWake RefSel (No. 351)** 95  
**Slip Adapt Iqs (No. 112)** 68  
**Slip Comp BW (No. 622)** 125  
**Slip Compensation Parameters** 125  
**Slip Reg Enable (No. 100)** 67  
**Slip Reg Ki (No. 101)** 67  
**Slip Reg Kp (No. 102)** 67  
**Slip RPM at FLA (No. 621)** 125  
**SLS Out Mode (No. 73)** 301  
**SO Accel Time (No. 1591)** 216  
**SO Cnts per Rvls (No. 1587)** 216

- SO Config (No. 1580) 215
- SO Decel Time (No. 1592) 217
- SO EPR Input (No. 1584) 216
- SO Fwd Vel Lmt (No. 1593) 217
- SO Offset (No. 1583) 216
- SO Position Out (No. 1589) 216
- SO Rev Vel Lmt (No. 1594) 217
- SO Rvls Input (No. 1585) 216
- SO Rvls Output (No. 1586) 216
- SO Setpoint (No. 1582) 216
- SO Status (No. 1581) 216
- SO Unit Out (No. 1590) 216
- SO Unit Scale (No. 1588) 216
- Spd Err Fltr BW (No. 644) 128
- Spd Loop Damping (No. 653) 129
- Spd Options Ctrl (No. 635) 126
- Spd Ref Filter (No. 588) 121
- Spd Ref Fltr BW (No. 589) 121
- Spd Ref FltrGain (No. 590) 121
- Spd Ref *n* AnlgHi (No. 547, 552) 119
- Spd Ref *n* AnlgLo (No. 548, 553) 119
- Spd Ref *n* Mult (No. 549, 554) 119
- Spd Ref *n* Sel (No. 545, 550) 119
- Spd Ref *n* Stpt (No. 546, 551) 119
- Spd Ref Scale (No. 555) 119
- Spd Ref Sel Sts (No. 591) 122
- Spd Reg Int Out (No. 654) 130
- Spd Reg Neg Lmt (No. 656) 130
- Spd Reg Pos Lmt (No. 655) 130
- Spd Trim Source (No. 617) 124
- SpdBand Intgrtr (No. 1106) 185
- SpdReg AntiBckup (No. 643) 127
- SpdTrimPrcRefSrc (No. 616) 124
- SpdTrqPsn Mode *n* (No. 309...312) 88
- Speed and Position Feedback**
  - Block Diagram (753) 379
  - Block Diagram (755) 415
- Speed Comp Gain (No. 666) 131
- Speed Comp Out (No. 667) 131
- Speed Comp Sel (No. 665) 131
- Speed Compensation Parameters 131
- Speed Control**
  - Block Diagram (753) 380
  - Block Diagram (755) 416
- Speed Control Parameters 117
- Speed Dev Band (No. 1105) 185
- Speed Error (No. 641) 127
- Speed Hysteresis (No. 56) 305
- Speed Limits Parameters 117, 118
- Speed Rate Ref (No. 596) 123
- Speed Ref Source (No. 930) 161
- Speed Reference Parameters 119
- Speed References 74
- Speed Reg BW (No. 636) 126
- Speed Reg Ki (No. 647) 128
- Speed Reg Kp (No. 645) 128
- Speed Reg Max Kp (No. 646) 128
- Speed Regulation**
  - Setting Gains for Primary and Alternate Feedback Sources 126
- Speed Regulator Parameters 126
- Speed Torque Position 88
- Speed Trim Parameters 123
- Speed Units (No. 300) 86
- Spindle Orientation Configuration** 215
- Spindle Orientation Parameters 215, 216
- SReg FB Fltr BW (No. 639) 127
- SReg FB Fltr Sel (No. 637) 127
- SReg FB FltrGain (No. 638) 127
- SReg OutFltr BW (No. 659) 130
- SReg OutFltr Sel (No. 657) 130
- SReg OutFltrGain (No. 658) 130
- SReg Output (No. 660) 130
- SReg Trq Preset (No. 652) 129
- SS Out Mode (No. 72) 301
- Stab Angle Gain (No. 52) 59
- Stab Volt Gain (No. 51) 59
- Stability Filter (No. 50) 59
- Standstill Pos (No. 49) 304
- Standstill Speed (No. 48) 304
- Start Acc Boost (No. 60) 62
- Start At PowerUp (No. 345) 93
- Start Features Parameters 92, 93
- Start Inhibits (No. 933) 162
- Start Owner (No. 920) 158
- Start Up**
  - Check List 17
- Status Indicators 20, 314
  - Communication Adapters 20
- Status Parameters 161
- Status $n$  at Fault (No. 954, 955) 171
- Step *n* Accel (No. 1232...1382) 199
- Step *n* Action (No. 1238...1388) 203
- Step *n* Batch (No. 1236...1386) 202
- Step *n* Decel (No. 1233...1383) 200
- Step *n* Dig In (No. 1239...1389) 204
- Step *n* Dwell (No. 1235...1385) 202
- Step *n* Next (No. 1237...1387) 203
- Step *n* Type (No. 1230...1380) 198
- Step *n* Value (No. 1234...1384) 201
- Step *n* Velocity (No. 1231...1381) 199
- Stop Decel Tol (No. 51) 304
- Stop Dwell Time (No. 392) 100
- Stop Mode *n* (No. 370, 371) 97
- Stop Mon Delay (No. 46) 304
- Stop Owner (No. 919) 158
- Stroke Per Min (No. 1202) 194
- Stroke Pos Count (No. 1201) 194



**Subnet Cfg *n* (No. 42...45)** 241  
**Support, Product** 373  
**SVC Boost Filter (No. 64)** 62  
**Sync Time (No. 1122)** 187  
**Sys Rated Amps**  
     No. 1 – Converter 227, 232  
     No. 1 – Inverter 222  
**Sys Rated Volts**  
     No. 2 – Converter 227, 232  
     No. 2 – Inverter 222

## T

### Technical Support

Contacting 373  
**Testpoint Fval *n* (No. 971...983)** 176  
**Testpoint Lval *n* (No. 972...984)** 176  
**Testpoint Sel *n***  
     No. 30, 32 – Converter 228, 233  
     No. 30, 32 – Inverter 223  
     No. 970...982 – Main Control Board 176  
**Testpoint Val *n***  
     No. 31, 33 – Converter 228, 233  
     No. 31, 33 – Inverter 223  
**Testpoints Parameters** 176  
**To Peer Enable (No. 91)** 246  
**To Peer Period (No. 89)** 246  
**To Peer Skip (No. 90)** 246  
**T00 Level (No. 22)** 254, 264  
**T00 Level (No. 242)** 80  
**T00 Level CmpSts (No. 23)** 254, 264  
**T00 Level CmpSts (No. 243)** 80  
**T00 Level Sel (No. 21)** 254, 264  
**T00 Level Sel (No. 241)** 80  
**T00 Off Time (No. 245)** 81  
**T00 Off Time (No. 25)** 255, 265  
**T00 On Time (No. 24)** 254, 264  
**T00 On Time (No. 244)** 81  
**T00 Sel (No. 20)** 254, 264  
**T00 Sel (No. 240)** 80  
**T01 Level (No. 32)** 255, 265  
**T01 Level CmpSts (No. 33)** 255, 265  
**T01 Level Sel (No. 31)** 255, 265  
**T01 Off Time (No. 35)** 255, 265  
**T01 On Time (No. 34)** 255, 265  
**T01 Sel (No. 30)** 255, 265  
**TorqAlarm Action (No. 1168)** 190  
**TorqAlarm Config (No. 1169)** 190  
**TorqAlarm Dwell (No. 1170)** 190  
**TorqAlarm Level (No. 1171)** 190  
**TorqAlarm LoLvl (No. 1185)** 191  
**TorqAlarm TOActn (No. 1173)** 190  
**TorqAlm Timeout (No. 1172)** 190  
**Torque Boost Parameters** 211  
**Torque Control**

    Block Diagram (753) 391, 392  
     Block Diagram (755) 433, 434  
**Torque Cur Fdbk (No. 5)** 54  
**Torque Limits Parameters** 132  
**Torque Prove** 523  
**Torque Prove Parameters** 184  
**Torque Reference Parameters** 132  
**Torque Setpoint (No. 1194)** 193  
**Torque Step (No. 686)** 133  
**Total Gear Ratio (No. 1174)** 191  
**Total Inertia (No. 76)** 63  
**Traverse**  
     Fiber Control 187  
     Increment and Decrement 187  
**Traverse Dec (No. 1124)** 187  
**Traverse Inc (No. 1123)** 187  
**Trim Ref *n* Sel (No. 600, 604)** 123  
**Trim Ref *n* Stpt (No. 601, 605)** 123  
**Trim Refn AnlgHi (No. 602, 606)** 124  
**Trim Refn AnlgLo (No. 603, 607)** 124  
**TrmPct Refn AnHi (No. 610, 614)** 124  
**TrmPct Refn AnLo (No. 611, 615)** 124  
**TrmPct Refn Sel (No. 608, 612)** 124  
**TrmPct Refn Stpt (No. 609, 613)** 124  
**Troubleshooting** 311  
     Common Symptoms 369  
     Crane Setup Encoderless 474  
     Crane Setup with Encoder 466  
**Trq Adapt En (No. 107)** 68  
**Trq Adapt Speed (No. 106)** 68  
**Trq Comp Mode (No. 109)** 68  
**Trq Comp Mtring (No. 110)** 68  
**Trq Comp Regen (No. 111)** 68  
**Trq Lmt SlewRate (No. 1104)** 185  
**Trq Prove Cfg (No. 1100)** 184  
**Trq Prove Setup (No. 1101)** 184  
**Trq Prove Status (No. 1103)** 185  
**Trq Ref *n* AnlgHi (No. 677, 682)** 132  
**Trq Ref *n* AnlgLo (No. 678, 683)** 132  
**Trq Ref *n* Mult (No. 679, 684)** 132  
**Trq Ref *n* Sel (No. 675, 680)** 132  
**Trq Ref *n* Stpt (No. 676, 681)** 132  
**Type 2 Alarms (No. 961)** 174

## U

**UnderVltg Action (No. 460)** 107  
**UnderVltg Level (No. 461)** 107  
**Units Traveled (No. 1212)** 195  
**Universal Feedback Module**  
     Parameters 281  
**User Home Psn (No. 738)** 143  
**UserData Int 00...31 (No. 1700...1731)** 160  
**UserData Int 00...31 (No. 1800...31)** 160

**V**

**VB Accel Rate (No. 1541)** 214  
**VB Config (No. 1535)** 213  
**VB Cur Thresh (No. 1550)** 215  
**VB Current Hyst (No. 1549)** 215  
**VB Current Rate (No. 1548)** 215  
**VB Decel Rate (No. 1542)** 214  
**VB Filt Flux Cur (No. 1547)** 214  
**VB Flux Lag Freq (No. 1546)** 214  
**VB Flux Thresh (No. 1545)** 214  
**VB Frequency (No. 1543)** 214  
**VB Maximum (No. 1540)** 214  
**VB Min Freq (No. 1544)** 214  
**VB Minimum (No. 1539)** 214  
**VB Rate Lag Freq (No. 1551)** 215  
**VB Status (No. 1536)** 213  
**VB Time (No. 1538)** 214  
**VB Voltage (No. 1537)** 213  
**VCL Cur Reg BW (No. 95)** 67  
**VCL Cur Reg Ki (No. 97)** 67  
**VCL Cur Reg Kp (No. 96)** 67  
**Vector Regulation Parameters** 67  
**Velocity Feedback** 71  
**VEncdls FReg Ki (No. 99)** 67  
**VEncdls FReg Kp (No. 98)** 67  
**Vendor Password (No. 19)** 299

**VHz Curve (No. 65)** 62  
**VHzSV Spd Reg Ki (No. 664)** 130  
**VHzSV Spd Reg Kp (No. 663)** 130  
**VHzSV SpdTrimReg (No. 623)** 125  
**Viewing Parameters** 319  
**Virtual Enc EPR (No. 141)** 72  
**Virtual Enc Psn (No. 142)** 72  
**Virtual EncDelay (No. 140)** 72  
**Voltage Class (No. 305)** 87  
**Voltage Tolerance** 455  
**Volts per Hertz Parameters** 62

**W**

**Wake Level (No. 354)** 95  
**Wake Time (No. 355)** 95  
**Web Enable (No. 52)** 242  
**Web Features (No. 53)** 242  
**Write Mask Act (No. 887)** 156  
**Write Mask Cfg (No. 888)** 156

**Z**

**Zero Position (No. 725)** 140  
**Zero Speed Limit (No. 525)** 117  
**ZeroSpdFloatTime (No. 1113)** 186



## Rockwell Automation Support

Use the following resources to access support information.

<b>Technical Support Center</b>	Knowledgebase Articles, How-to Videos, FAQs, Chat, User Forums, and Product Notification Updates.	<a href="https://rockwellautomation.custhelp.com/">https://rockwellautomation.custhelp.com/</a>
<b>Local Technical Support Phone Numbers</b>	Locate the phone number for your country.	<a href="http://www.rockwellautomation.com/global/support/get-support-now.page">http://www.rockwellautomation.com/global/support/get-support-now.page</a>
<b>Direct Dial Codes</b>	Find the Direct Dial Code for your product. Use the code to route your call directly to a technical support engineer.	<a href="http://www.rockwellautomation.com/global/support/direct-dial.page">http://www.rockwellautomation.com/global/support/direct-dial.page</a>
<b>Literature Library</b>	Installation Instructions, Manuals, Brochures, and Technical Data.	<a href="http://www.rockwellautomation.com/global/literature-library/overview.page">http://www.rockwellautomation.com/global/literature-library/overview.page</a>
<b>Product Compatibility and Download Center (PCDC)</b>	Get help determining how products interact, check features and capabilities, and find associated firmware.	<a href="http://www.rockwellautomation.com/global/support/pcdc.page">http://www.rockwellautomation.com/global/support/pcdc.page</a>

## Documentation Feedback

Your comments will help us serve your documentation needs better. If you have any suggestions on how to improve this document, complete the How Are We Doing? form at [http://literature.rockwellautomation.com/idc/groups/literature/documents/du/ra-du002\\_-en-e.pdf](http://literature.rockwellautomation.com/idc/groups/literature/documents/du/ra-du002_-en-e.pdf).

Rockwell Automation maintains current product environmental information on its website at <http://www.rockwellautomation.com/rockwellautomation/about-us/sustainability-ethics/product-environmental-compliance.page>.

Allen-Bradley, Connected Components Workbench, DeviceLogix, DPI, DriveExecutive, DriveExplorer, DriveTools, Kinetix, PowerFlex, Rockwell Automation, Rockwell Software, RSLogix 5000, RSNetWorx, SCANPort, Studio 5000 Logix Designer, and TorqProve are trademarks of Rockwell Automation, Inc.

Rockwell Otomasyon Ticaret A.Ş., Kar Plaza İş Merkezi E Blok Kat:6 34752 İçerenköy, İstanbul, Tel: +90 (216) 5698400

**[www.rockwellautomation.com](http://www.rockwellautomation.com)**

### Power, Control and Information Solutions Headquarters

Americas: Rockwell Automation, 1201 South Second Street, Milwaukee, WI 53204-2496 USA, Tel: (1) 414.382.2000, Fax: (1) 414.382.4444

Europe/Middle East/Africa: Rockwell Automation NV, Pegasus Park, De Kleetlaan 12a, 1831 Diegem, Belgium, Tel: (32) 2 663 0600, Fax: (32) 2 663 0640

Asia Pacific: Rockwell Automation, Level 14, Core F, Cyberport 3, 100 Cyberport Road, Hong Kong, Tel: (852) 2887 4788, Fax: (852) 2508 1846

Publication 750-PM0010-EN-P - November 2018

Supersedes Publication 750-PM001N-EN-P - February 2017

PN-511186

Copyright © 2018 Rockwell Automation, Inc. All rights reserved. Printed in the U.S.A.